

# X Band High Power Amplifier

## GaAs Monolithic Microwave IC

### Description

The CHA7114 is a monolithic two-stage GaAs high power amplifier designed for X band applications.

This device is manufactured using a UMS 0.25 $\mu$ m power pHEMT process, including, via holes through the substrate and air bridges.

To simplify the assembly process:

- The backside of the chip is both RF and DC grounded
- Bond pads and back side are gold plated for compatibility with eutectic die attach method and thermo-compression bonding process.

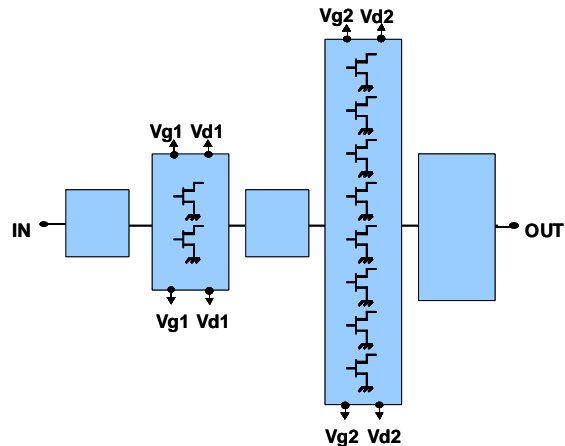

### Main Features

- 0.25 $\mu$ m Power pHEMT Technology
- 8.5–11.5GHz Frequency Range
- 8W Output Power @ 4dBcp
- High PAE: > 40% @ 4dBcp
- 20dB nominal Gain
- Quiescent Bias point:  $V_d = 8V$ ,  $I_d = 2A$
- Chip size: 4.41 x 3.31 x 0.07mm

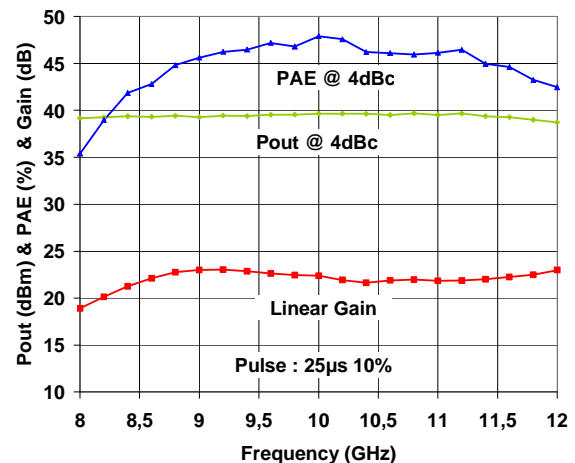

### Main Characteristics

$T_{amb} = +25^{\circ}C$  ( $T_{amb}$  is the back-side of the chip)

$V_d = 8V$ ,  $I_d$  (Quiescent) = 2A, Pulse width = 25 $\mu$ s, Duty cycle = 10%

Symbol	Parameter	Min	Typ	Max	Unit
Top	Operating temperature range	-40		+80	$^{\circ}C$
Fop	Operating frequency range	8.5		11.5	GHz
P_4dBcp	Output power @ 4dBcp @ 25 $^{\circ}C$		8		W
G	Small signal gain @ 25 $^{\circ}C$		20		dB

ESD Protections: Electrostatic discharge sensitive device. Observe handling precautions!

## Electrical Characteristics

Tamb = 25°C, Vd = 8V, Id (Quiescent) = 2A, Pulse width = 25µs, Duty cycle=10%

Symbol	Parameter	Min	Typ	Max	Unit
Fop	Operating frequency	8.5		11.5	GHz
G	Small signal gain	17.5	20	23	dB
G_T	Small signal gain variation versus temperature		-0.033		dB/°C
RLin	Input Return Loss	8	10		dB
RLout	Output Return Loss	6	8		dB
Psat	Saturated output power		39.8		dBm
Psat_T	Saturated output power variation versus temperature		-0.008		dB/°C
P_4dBcp	Output power @ 4dBcp (2)	38	39		dBm
PAE_4dBcp	Power Added Efficiency @ 4dBcp	36	42		%
Id	Supply drain current		2.3	2.6	A
Vd1, Vd2	Drain supply voltage (2)		8.0	8.5	V
Id_q	Supply quiescent drain current (1)		2.0		A
Vg1, Vg2	Gate Power supply voltage		-4.0		V
Top	Operating temperature range	-40		+80	°C

(1) Parameter to be adjusted by tuning of Vg

(2) 0.5V variation on Vd leads to around 0.4dB variation of the output power (impact on robustness see Maximum ratings)

## Absolute Maximum Ratings (1)

Tamb = 25°C

Symbol	Parameter	Values	Unit
Cmp	Compression level (2)	6	dB
Vd	Drain Power supply voltage (3)	10	V
Id	Drain Power supply quiescent current	2.5	A
Id_sat	Drain Power supply current in saturation	3	A
Vg	Gate Power supply voltage	-8	V
Tj	Maximum junction temperature (4)	175	°C
Tstg	Storage temperature range	-55 to +125	°C

- (1) Operation of this device above anyone of these parameters may cause permanent damage.
- (2) For higher compression the level limit can be increased by decreasing the voltage Vd using the rate 0.5V/dBcp
- (3) Without RF input power
- (4) Equivalent Thermal Resistance to Backside: 5.6°C/W for backside temp. of 80°C.  
*[ Junction Temperature comes from:  $T_j = T_{backside} + ETRB \times (\text{Dissipated Power})$   
 Where **ETRB** stands for Equivalent Thermal Resistance to Backside. ]*

Typical measured characteristics

Measurements on Jig:

Vd = 8V, Vg = -4.0V, Id (Quiescent) = 2.2A, Pulse width = 25µs, Duty cycle = 10%

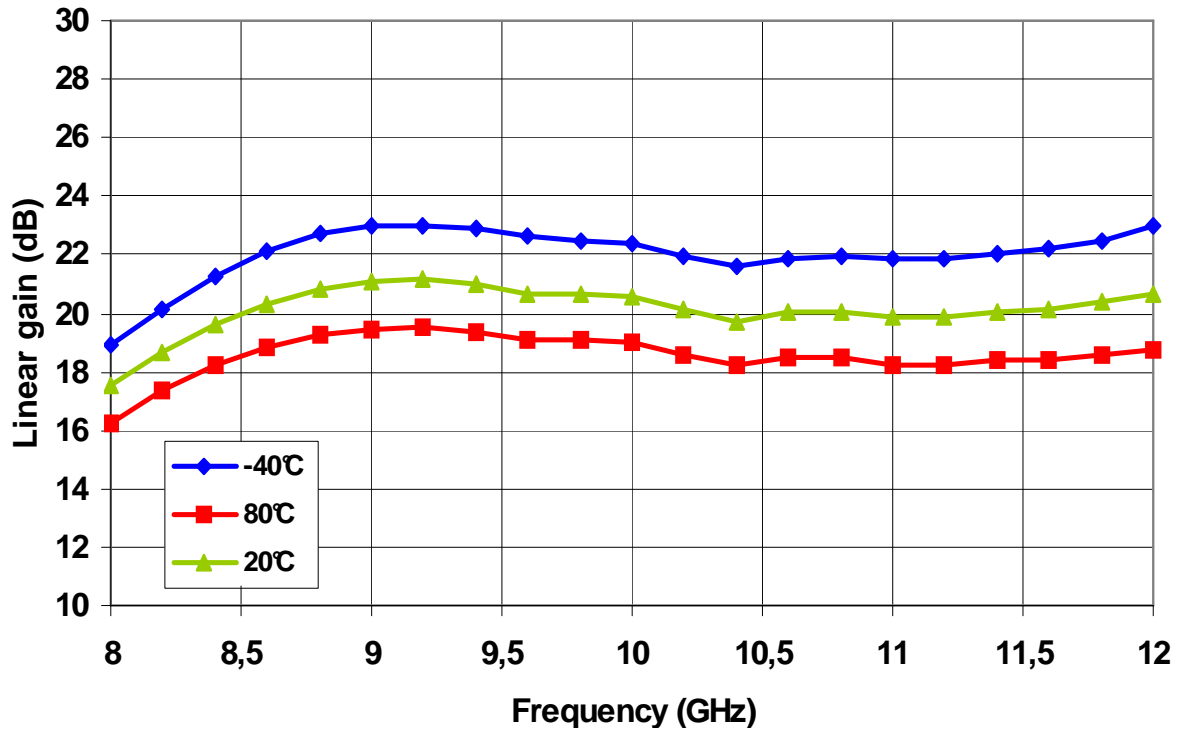

Linear gain versus frequency and temperature

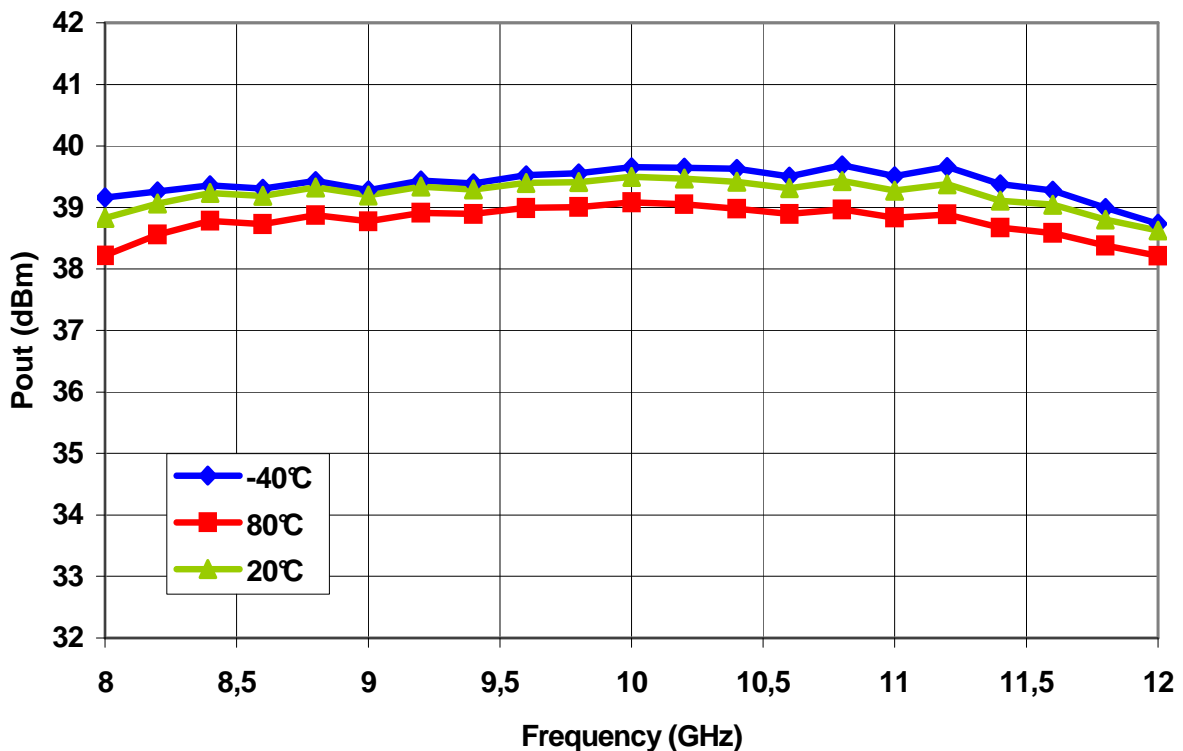

Output Power @ 4dBcp versus frequency and temperature

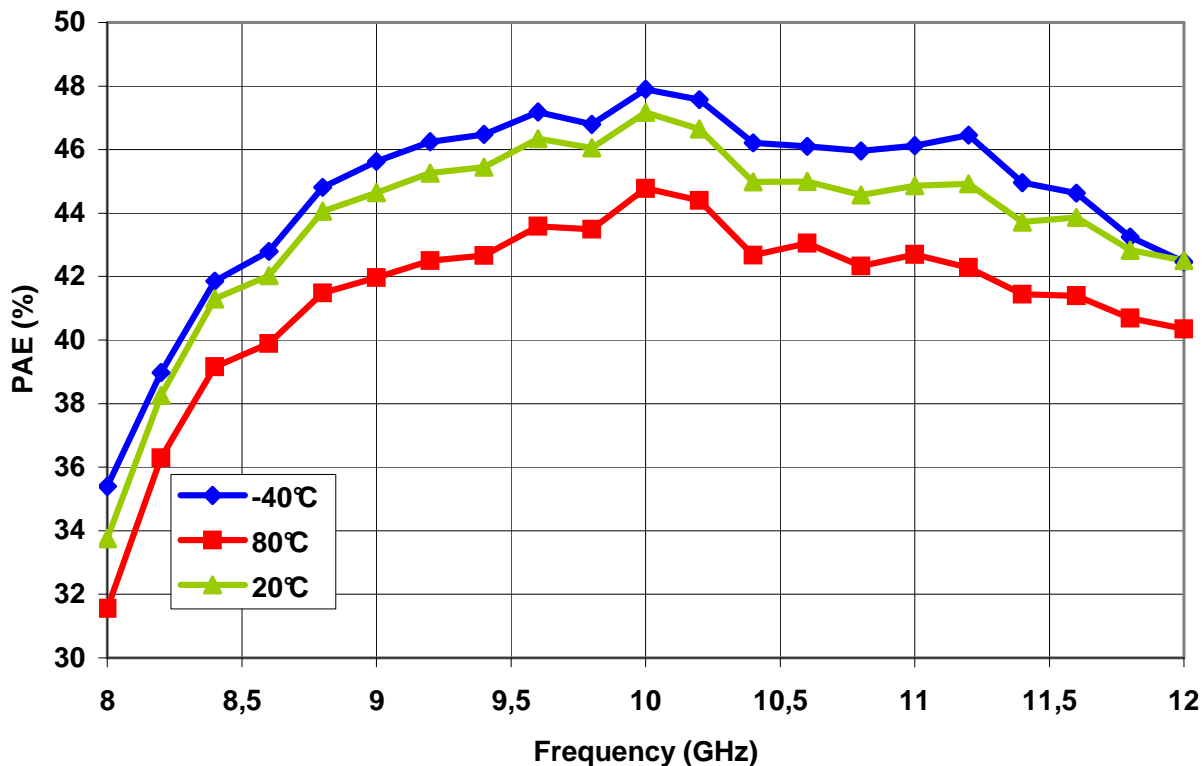

PAE @ 4dBcp versus frequency and temperature

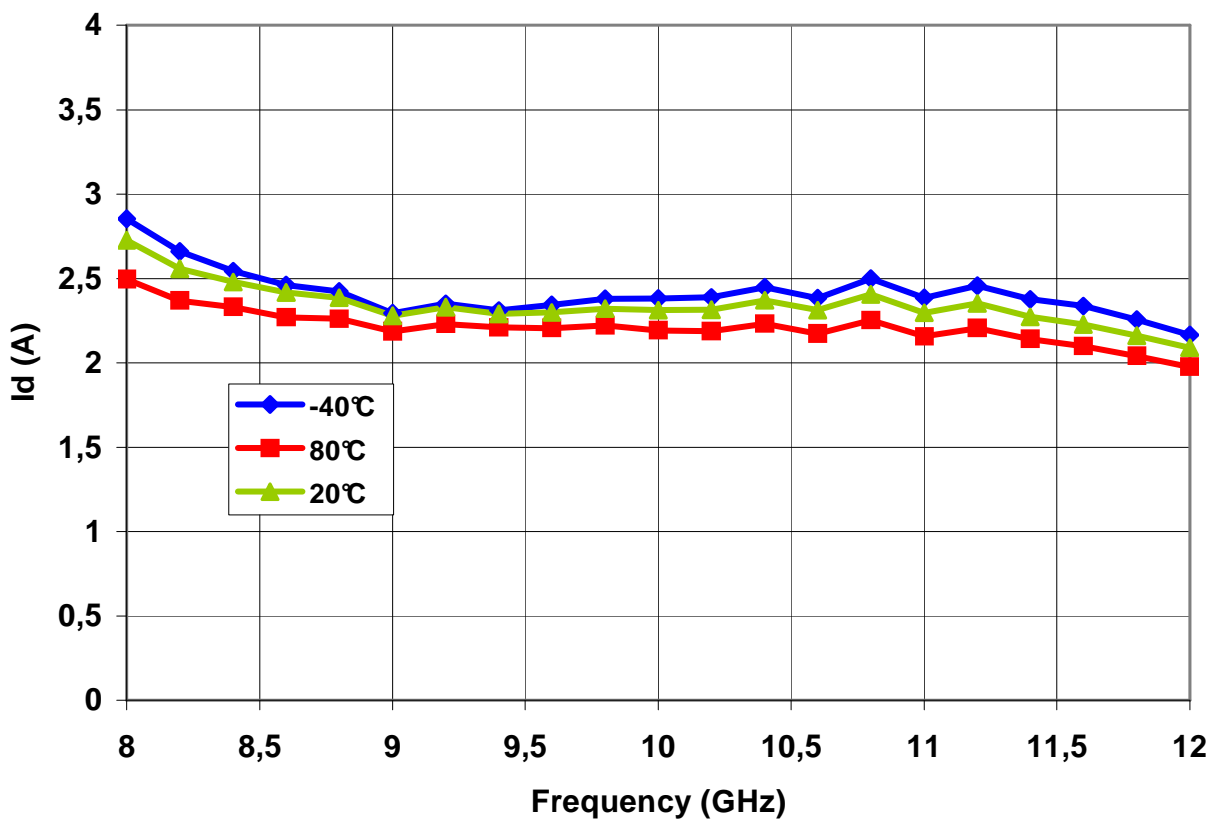

Id @ 4dBcp versus frequency and temperature

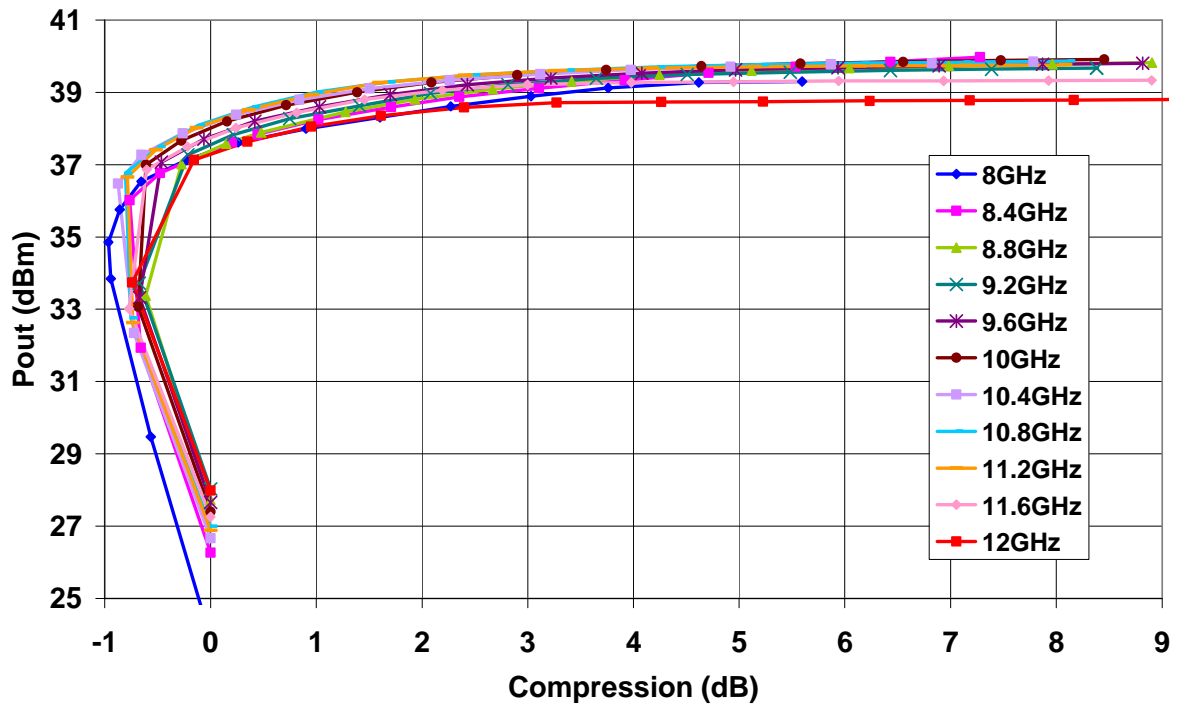

Output Power @ 25°C versus compression and frequency

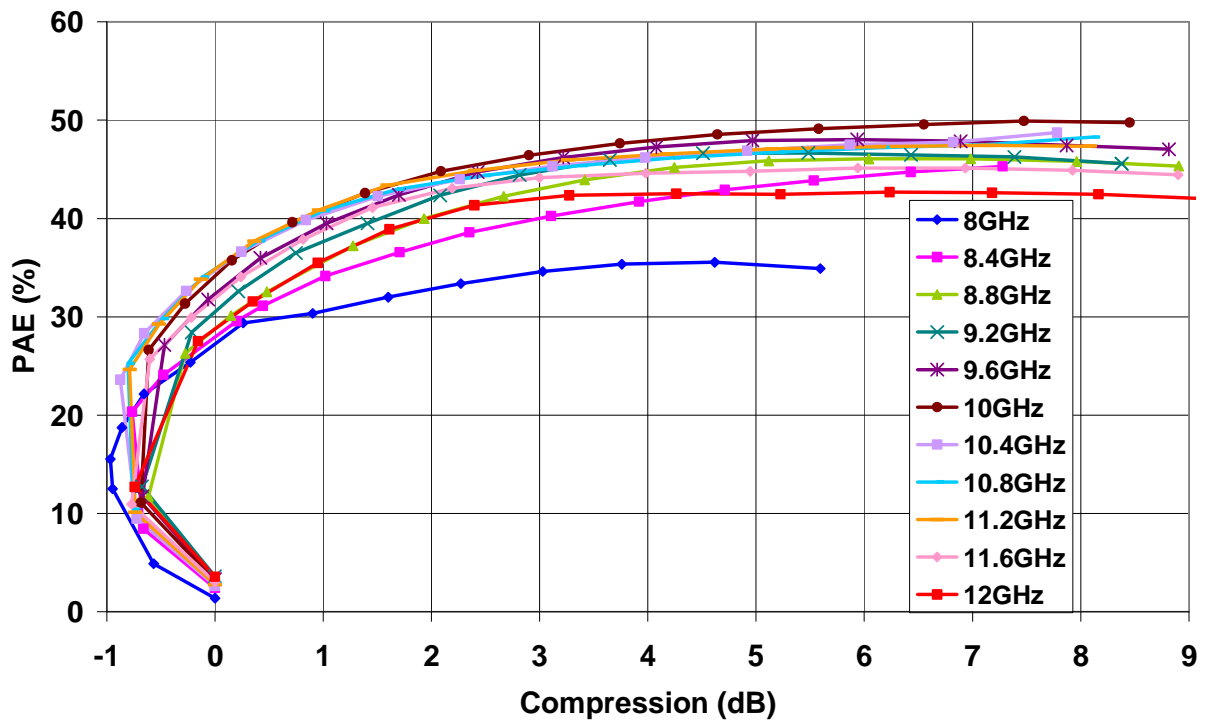

PAE @ 25°C versus compression and frequency

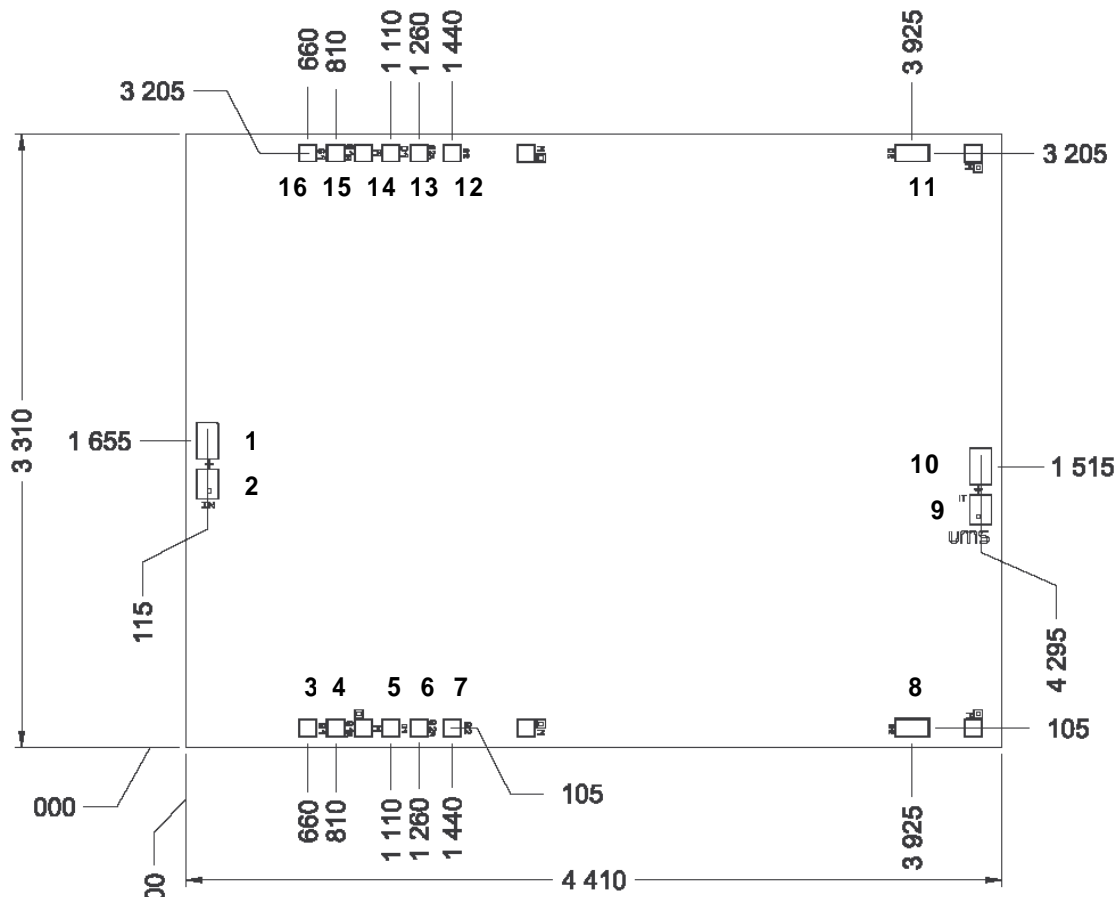

## Chip Mechanical Data and Pin references

Chip width and length are given with a tolerance of +/- 35µm

Chip thickness = 70µm +/- 10µm

HF pads (1, 10) = 118µm x 196µm

DC pads (3, 4, 5, 6, 7, 12, 13, 14, 15, 16) = 96µm x 96µm

DC pads (8, 11) = 186µm x 96µm

Pin number	Pin name	Description
2, 9		Not Connected
3, 7, 12, 16	G1, G2	Not Connected
1	IN	Input RF port
4, 6, 13, 15	Vg1R, Vg2R	Vg: Negative supply voltage (through divided bridge Network)
5, 8, 11, 14	Vd1, Vd2	Vd: Positive supply voltage
10	OUT	Output RF port

**Bonding recommendations**

Port	Connection	External capacitor
IN	Inductance ( $L_{bonding}$ ) = 0.3nH 2 gold wires bondings (550 $\mu$ m max)	
OUT	Inductance ( $L_{bonding}$ ) = 0.3nH 2 gold wires bondings (550 $\mu$ m max)	
Vd1, Vd2	Inductance $\leq$ 1nH	C1 ~ 100pF
Vg1R, Vg2R	Inductance $\leq$ 1nH	C1 ~ 100pF C2 ~ 10nF

**Assembly recommendations (drain voltage pulsed mode operation)**

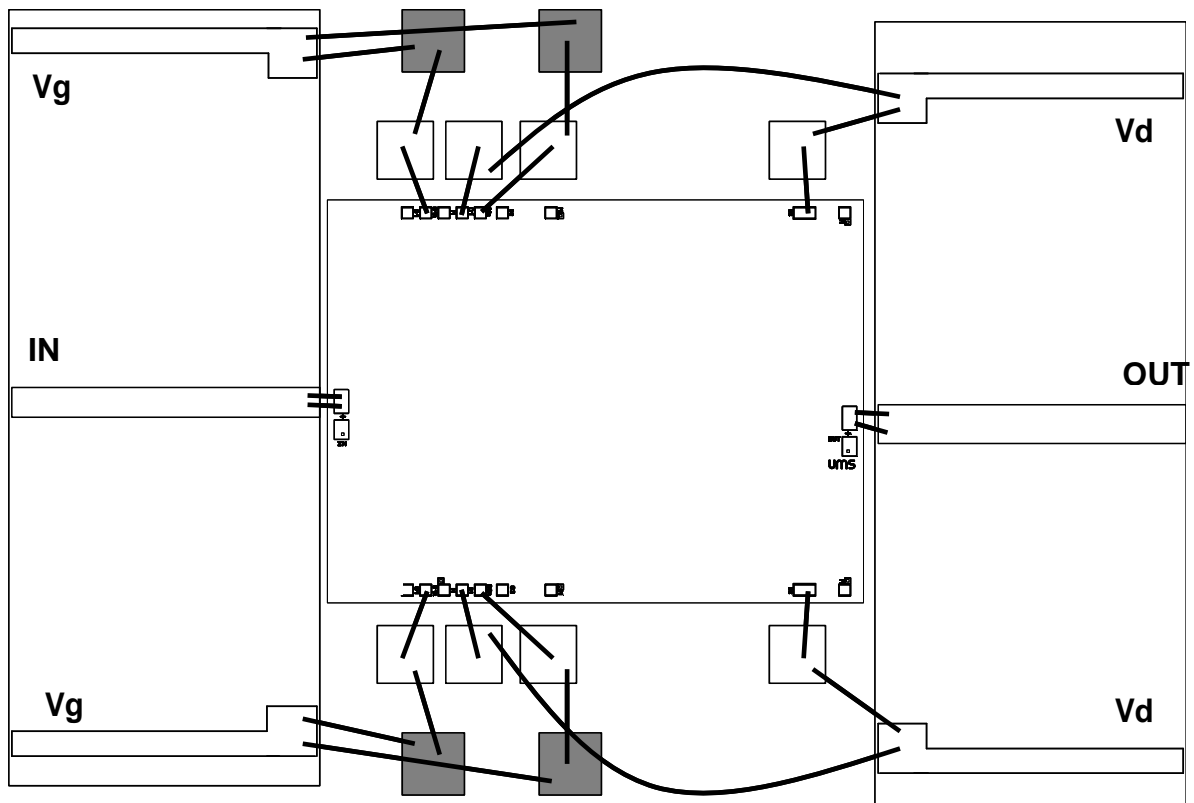

**Vg:** gate supply voltage  
**Vd:** drain supply voltage

## Ordering Information

Chip form : CHA7114-99F/00

Information furnished is believed to be accurate and reliable. However **United Monolithic Semiconductors S.A.S.** assumes no responsibility for the consequences of use of such information nor for any infringement of patents or other rights of third parties which may result from its use. No license is granted by implication or otherwise under any patent or patent rights of **United Monolithic Semiconductors S.A.S.** Specifications mentioned in this publication are subject to change without notice. This publication supersedes and replaces all information previously supplied. **United Monolithic Semiconductors S.A.S.** products are not authorized for use as critical components in life support devices or systems without express written approval from **United Monolithic Semiconductors S.A.S.**