

DC-16GHz Attenuator

GaAs Monolithic Microwave IC in SMD leadless package

Description

The CHT4660-QAG is a DC-16GHz variable attenuator designed for a wide range of applications, from military to commercial communication systems. The circuit is manufactured with a MESFET process, 0.7 μ m gate length, via holes through the substrate and air bridges.

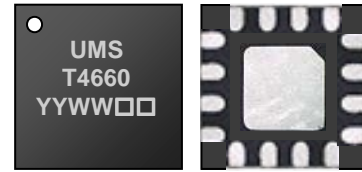

It is supplied in lead-free package.

Main Features

- Broadband performance: DC-16GHz
- 24dBm typical input 1dB compression point (any attenuation)
- 30dB dynamic range
- DC bias: $-5V < V1 < 0V$; $-5V < V2 < 0V$
- Package type: 16L-QFN3x3
- MSL 1

Attenuation versus frequency & V1, V2

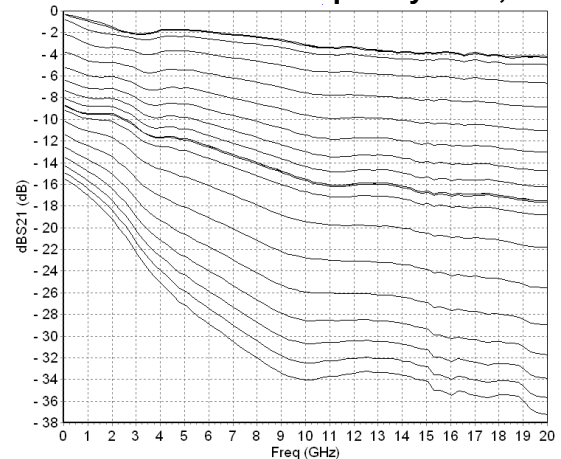

Main Characteristics

Tamb = +25°C

Symbol	Parameter	Min	Typ	Max	Unit
Fin	Input frequency range	DC		16	GHz
Min Att.	S21 (V1=-5V;V2=-5V)		2		dB
Max Att.	S21 (V1=0V;V2=0V)		32		dB
Pin1dB	Input 1dB compression point (any attenuation)		24		dBm

ESD Protections: Electrostatic discharge sensitive device observe handling precautions!

Electrical Characteristics

Tamb = +25°C

Symbol	Parameter	Min	Typ	Max	Unit
Fin	Input frequency range	DC		16	GHz
Min Att.	S21 (V1=-5V;V2=-5V) (DC to 4GHz)		1	2	dB
	S21 (V1=-5V;V2=-5V) (4 to 20GHz)		2	3	dB
Max Att.	S21 (V1=0V;V2=0V) (DC to 2GHz)	15	17		dB
	S21 (V1=0V;V2=0V) (2 to 4GHz)	18	20		dB
	S21 (V1=0V;V2=0V) (4 to 9GHz)	24	26		dB
	S21 (V1=0V;V2=0V) (9 to 16GHz)	30	32		dB
RLin	Input return loss (any att.) (DC to 4GHz)		-2	-1	dB
	Input return loss (any att.) (4 to 7GHz)		-6	-5	dB
	Input return loss (any att.) (7 to 16GHz)		-8	-7	dB
RLout	Output return loss (any att.) (DC to 4GHz)		-2	-1	dB
	Output return loss (any att.) (4 to 7GHz)		-6	-5	dB
	Output return loss (any att.) (7 to 16GHz)		-10	-9	dB
Pin1dB	Input 1dB compression (any att.) (DC to 4GHz)	20	21		dBm
	Input 1dB compression (any att.) (4 to 16GHz)	23	24		dBm
C/I3	C/I3@Pin/tone=0 dBm (any att.) (DC to 4GHz)	50	53		dB
	C/I3@Pin/tone=0 dBm (any att.) (4 to 16GHz)	52	55		dB
IIP3	IIP3 (any att.) (DC to 4GHz)	22	24		dB
	IIP3 (any att.) (4 to 16GHz)	23	25		dB
V1, V2	Voltage control range	-5		0	V

These values are representative of onboard measurements as defined on the drawing paragraph "Evaluation mother board".

Absolute Maximum Ratings ⁽¹⁾

Tamb = +25°C

Symbol	Parameter	Values	Unit
V1	V1 control voltage	-6V to +0.6V	V
V2	V2 control voltage	-6V to +0.6V	V
Pin	RF input power	30	dBm
Ta	Operating temperature range (reference on ground paddle)	-40 to +85	°C
Tstg	Storage temperature range	-55 to +155	°C

(1) Operation of this device above anyone of these parameters may cause permanent damage.

Typical biasing conditions

Tamb = +25°C

Symbol	Pin No.	Parameter	Values	Unit
V1	6	V1 control voltage	-5 to 0	V
V2	7	V2 control voltage	-5 to 0	V

Typical Package Sij parameters

Tamb = +25°C, V1 = -5V & V2= -5V – Minimum attenuation

Freq	dBS11	PhS11	dBS12	PhS12	dBS21	PhS21	dBS22	PhS22
0.1	-37.1	-179.6	-0.3	-6.6	-0.1	-6.6	-38.2	-175.6
0.3	-29.5	-138.2	-0.4	-38.4	-0.2	-38.5	-30.4	-142.8
0.6	-23.6	-161.5	-0.5	-69.9	-0.3	-70.0	-24.9	-167.2
0.8	-20.9	165.7	-0.7	-101.2	-0.4	-101.3	-21.7	162.5
1.1	-19.4	132.7	-0.8	-132.2	-0.6	-132.3	-20.2	128.2
1.3	-18.5	97.0	-1.0	-163.1	-0.7	-163.3	-19.7	88.9
1.6	-18.3	59.1	-1.1	166.0	-0.8	165.9	-19.8	51.6
1.8	-18.1	21.7	-1.3	135.1	-0.9	135.1	-20.1	9.4
2.1	-17.6	-21.1	-1.5	104.4	-1.1	104.4	-20.1	-35.9
2.3	-17.3	-65.1	-1.8	74.5	-1.4	74.4	-20.9	-82.3
2.6	-17.4	-104.4	-1.9	44.5	-1.6	44.3	-21.9	-124.1
2.8	-17.2	-149.2	-2.1	15.8	-1.7	15.8	-24.3	-174.8
3.1	-18.2	170.3	-2.1	-13.4	-1.7	-13.5	-28.0	162.0
3.3	-20.2	136.6	-2.2	-42.8	-1.7	-42.9	-28.5	140.1
3.6	-24.0	111.5	-2.1	-72.4	-1.6	-72.4	-28.1	139.0
3.8	-30.3	127.1	-1.9	-101.7	-1.4	-101.8	-24.7	123.8
4.1	-24.8	136.4	-1.7	-132.6	-1.3	-132.8	-24.7	107.7
4.3	-21.7	109.3	-1.7	-164.0	-1.2	-164.1	-24.9	91.7
4.6	-21.2	76.0	-1.7	164.8	-1.2	164.7	-25.6	73.2
4.8	-22.0	53.0	-1.7	134.4	-1.2	134.2	-28.0	55.5
5.1	-23.0	17.5	-1.7	103.0	-1.2	103.0	-33.4	57.7
5.6	-37.2	-42.6	-1.8	41.3	-1.2	41.2	-25.2	88.6
6.1	-27.5	72.5	-1.9	-20.6	-1.3	-20.7	-18.7	41.6
6.6	-22.5	15.7	-2.1	-82.2	-1.4	-82.2	-16.6	-12.3
7.1	-21.8	-39.2	-2.2	-143.6	-1.5	-143.7	-17.1	-69.8
7.6	-25.3	-92.0	-2.2	154.7	-1.6	154.4	-19.5	-135.3
8.1	-34.5	-137.6	-2.3	92.8	-1.6	92.7	-22.5	140.9
8.6	-42.8	-79.4	-2.5	30.7	-1.7	30.6	-21.8	48.6
9.1	-39.7	54.8	-2.7	-31.3	-1.9	-31.3	-18.6	-15.6
9.6	-22.7	4.7	-2.9	-92.7	-2.1	-93.0	-16.2	-63.4
10.1	-16.6	-51.7	-3.0	-154.1	-2.2	-154.5	-14.5	-106.9
10.6	-14.3	-111.0	-3.3	145.1	-2.4	144.8	-14.0	-154.9
11.1	-14.8	-169.5	-3.3	84.9	-2.4	84.6	-15.6	151.2
11.6	-19.2	136.7	-3.3	23.1	-2.3	23.0	-20.6	80.3
12.1	-27.1	129.5	-3.3	-38.9	-2.3	-39.0	-24.2	-44.4
12.6	-22.9	119.9	-3.5	-100.6	-2.5	-100.9	-19.4	-136.8
13.1	-20.5	51.1	-3.6	-161.7	-2.6	-161.9	-17.0	170.4
13.6	-19.1	-36.2	-3.7	137.0	-2.6	136.8	-16.2	131.9
14.1	-17.5	-119.3	-3.8	75.9	-2.6	75.9	-15.9	94.9
14.6	-17.2	169.7	-3.8	14.9	-2.7	14.4	-16.5	51.6
15.1	-18.1	109.2	-3.8	-46.3	-2.6	-46.8	-18.5	1.9
15.6	-17.8	54.7	-3.6	-107.1	-2.5	-108.4	-23.5	-51.3
16.1	-16.9	5.5	-3.6	-171.2	-2.5	-171.2	-31.2	-137.2
16.6	-15.2	-41.7	-4.0	127.1	-2.8	128.1	-26.1	98.4
17.1	-13.3	-87.4	-3.9	65.7	-2.5	66.7	-19.0	27.8
17.6	-12.5	-129.1	-4.0	2.7	-2.7	2.5	-14.7	-44.0
18.1	-12.2	-172.3	-4.0	-58.9	-2.7	-59.1	-12.6	-111.5
18.6	-13.1	140.3	-4.1	-121.3	-2.8	-121.3	-13.1	-171.5
19.1	-17.0	85.1	-4.1	176.6	-2.7	176.9	-17.2	141.7
19.6	-28.5	-0.5	-4.1	113.2	-2.6	113.8	-22.7	138.9

Tamb = +25°C, V1 = 0V & V2= 0V – Maximum attenuation

Freq	dBS11	PhS11	dBS12	PhS12	dBS21	PhS21	dBS22	PhS22
0.1	-1.7	174.2	-15.5	-7.7	-15.5	-8.1	-1.8	174.0
0.3	-2.0	145.2	-15.8	-44.7	-15.9	-44.8	-2.0	145.8
0.6	-2.3	117.1	-16.2	-80.5	-16.2	-80.6	-2.2	118.2
0.8	-2.5	89.6	-16.6	-115.4	-16.7	-115.5	-2.4	90.8
1.1	-2.9	61.6	-17.1	-150.0	-17.1	-150.1	-2.7	63.4
1.3	-3.2	33.8	-17.6	175.9	-17.6	175.9	-3.0	35.9
1.6	-3.6	6.2	-18.2	142.1	-18.2	142.0	-3.2	8.4
1.8	-4.0	-21.4	-18.7	108.0	-18.7	108.0	-3.5	-19.0
2.1	-4.3	-49.0	-19.3	74.4	-19.3	74.6	-3.7	-46.3
2.3	-4.7	-76.0	-20.0	41.5	-20.1	41.1	-4.0	-73.6
2.6	-5.0	-102.6	-20.8	8.2	-20.8	7.6	-4.3	-100.8
2.8	-5.4	-128.6	-21.6	-24.2	-21.6	-23.9	-4.5	-127.6
3.1	-5.7	-153.9	-22.4	-55.4	-22.5	-55.4	-4.8	-154.3
3.3	-6.0	-179.0	-23.3	-87.0	-23.2	-87.3	-5.0	179.6
3.6	-6.3	157.0	-24.0	-117.9	-24.0	-117.4	-5.2	153.9
3.8	-6.5	133.0	-24.6	-147.2	-24.7	-147.3	-5.3	128.8
4.1	-6.8	109.3	-25.3	-177.3	-25.2	-178.1	-5.5	104.2
4.3	-7.1	86.3	-25.8	151.8	-25.7	151.8	-5.7	79.7
4.6	-7.3	63.0	-26.3	121.3	-26.3	121.4	-6.1	55.5
4.8	-7.6	40.0	-26.9	91.1	-26.9	90.8	-6.4	31.1
5.1	-8.0	17.0	-27.2	60.5	-27.2	60.6	-6.8	6.3
5.6	-8.7	-30.0	-28.1	-0.6	-28.2	-1.1	-7.6	-43.2
6.1	-9.4	-78.2	-28.9	-63.3	-29.0	-63.0	-8.7	-93.9
6.6	-10.2	-127.9	-29.8	-124.8	-29.7	-125.2	-10.0	-147.4
7.1	-10.7	179.9	-30.6	173.1	-30.6	173.0	-10.9	156.0
7.6	-10.8	126.9	-31.4	111.2	-31.4	111.5	-11.3	99.6
8.1	-10.5	75.1	-32.1	50.8	-32.1	50.4	-11.4	45.7
8.6	-10.0	25.0	-32.8	-9.2	-32.9	-9.5	-11.2	-4.6
9.1	-9.4	-22.4	-33.5	-67.1	-33.5	-67.7	-11.0	-50.3
9.6	-9.0	-67.8	-33.8	-124.2	-33.9	-124.8	-11.1	-92.4
10.1	-8.9	-112.0	-34.0	177.8	-34.1	178.1	-11.6	-132.1
10.6	-9.0	-156.4	-33.9	122.0	-33.9	121.9	-12.5	-170.5
11.1	-9.5	157.9	-33.7	64.7	-33.7	64.2	-14.0	149.6
11.6	-10.2	109.7	-33.6	6.1	-33.6	6.3	-16.2	105.9
12.1	-10.9	58.1	-33.4	-51.2	-33.4	-51.7	-19.2	55.1
12.6	-11.3	3.2	-33.2	-110.3	-33.3	-110.0	-22.7	-9.6
13.1	-11.1	-52.2	-33.5	-167.4	-33.4	-167.5	-22.6	-90.2
13.6	-10.7	-105.6	-33.4	135.2	-33.4	135.0	-19.8	-151.4
14.1	-10.3	-157.2	-33.6	77.8	-33.7	77.4	-17.6	164.3
14.6	-10.1	153.0	-33.9	21.4	-34.0	20.7	-16.5	126.2
15.1	-9.9	102.7	-34.3	-37.9	-34.2	-37.8	-15.8	87.5
15.6	-9.8	51.9	-34.9	-88.1	-35.0	-90.3	-15.6	51.1
16.1	-9.3	2.1	-35.0	-143.6	-35.5	-142.2	-15.4	15.8
16.6	-8.6	-47.0	-35.2	161.5	-35.1	162.4	-15.2	-22.0
17.1	-8.1	-93.3	-35.5	106.0	-35.5	105.8	-15.0	-61.3
17.6	-7.8	-137.3	-35.7	50.2	-35.7	51.2	-14.1	-100.6
18.1	-8.1	179.8	-35.4	-5.0	-35.4	-5.7	-13.3	-140.2
18.6	-8.7	136.7	-35.4	-66.3	-35.5	-66.5	-12.9	-179.6
19.1	-9.9	90.2	-36.1	-128.7	-36.1	-128.3	-13.6	140.2
19.6	-11.3	35.4	-37.0	174.7	-37.1	174.5	-15.3	97.5

The Sij measurement calibration planes are defined in the paragraph "Definition of the Sij reference planes".

Typical Measured Performances

Tamb = +25°C, Measurements in the package access planes

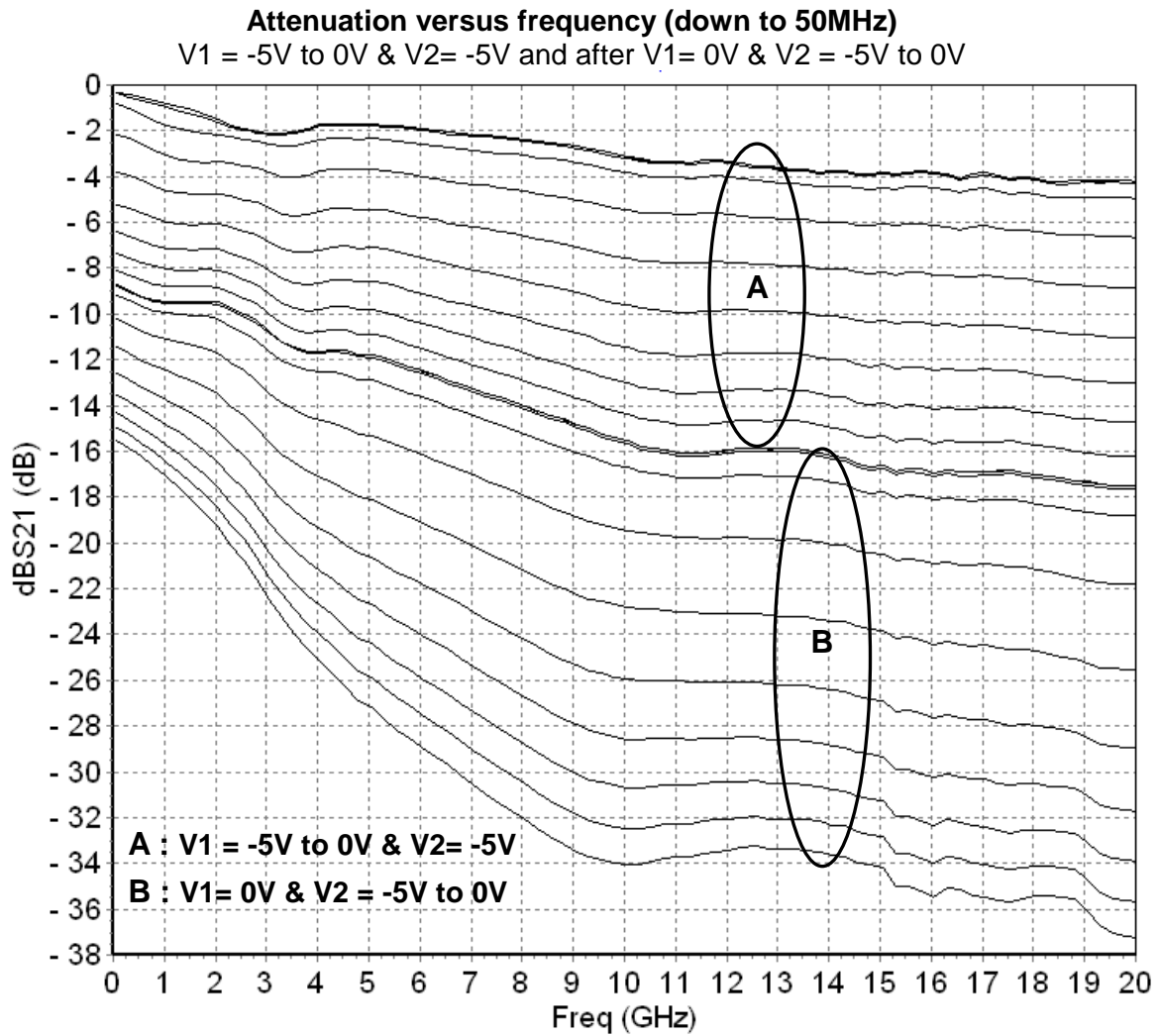

Input Return loss versus frequency in total attenuation range

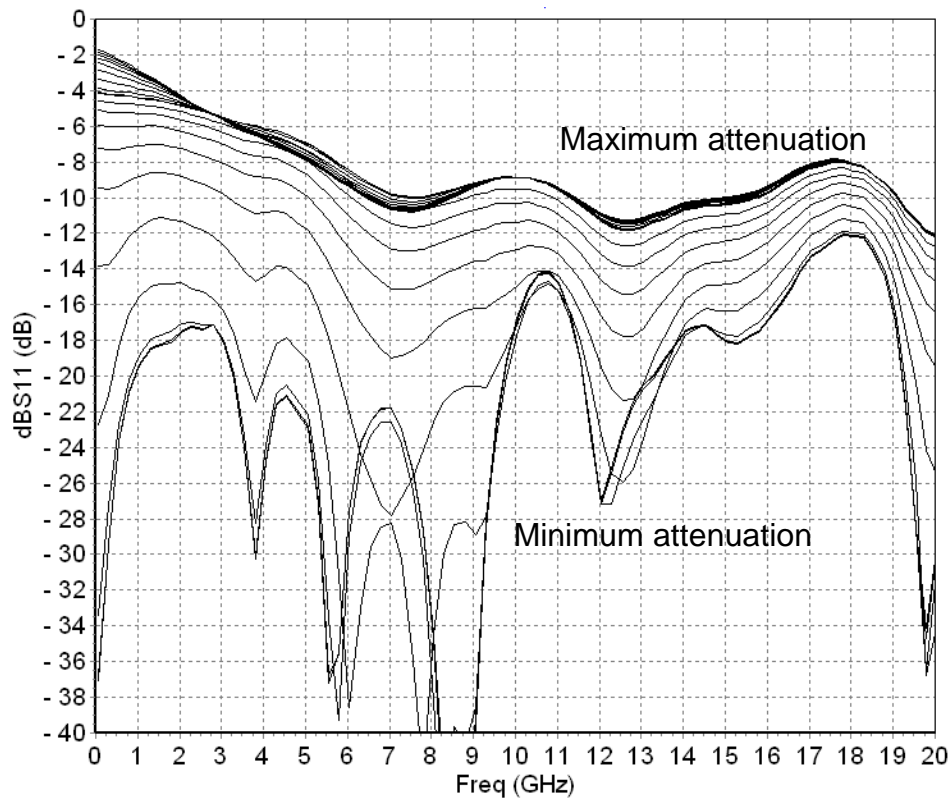

Output Return loss versus frequency in total attenuation range

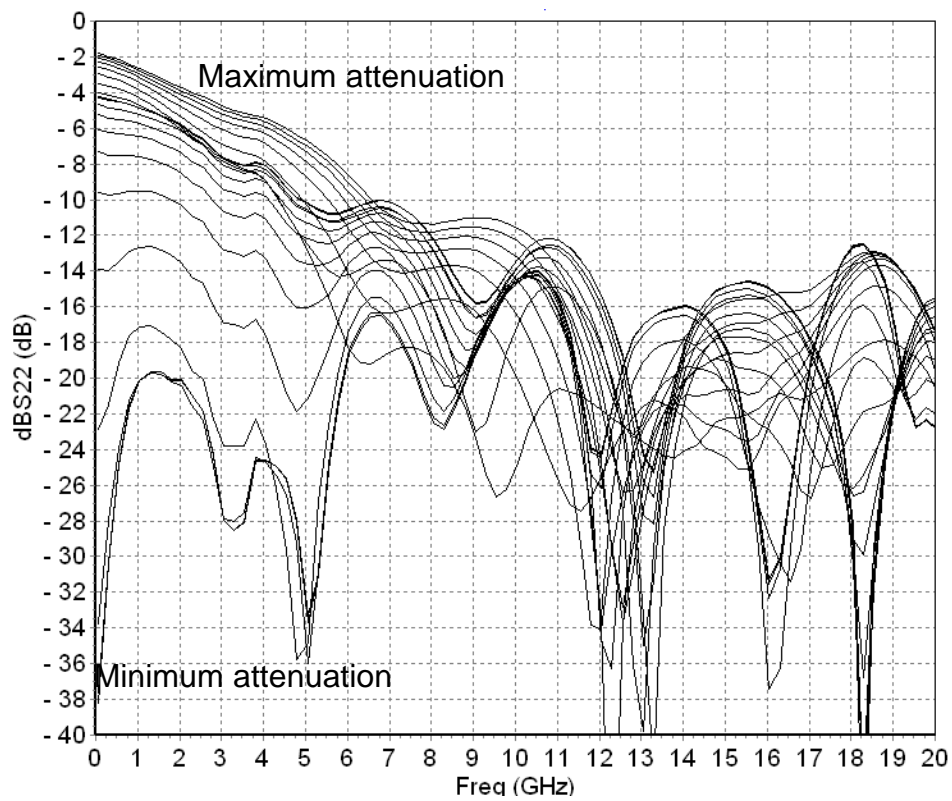

Attenuation control with V2=-5V

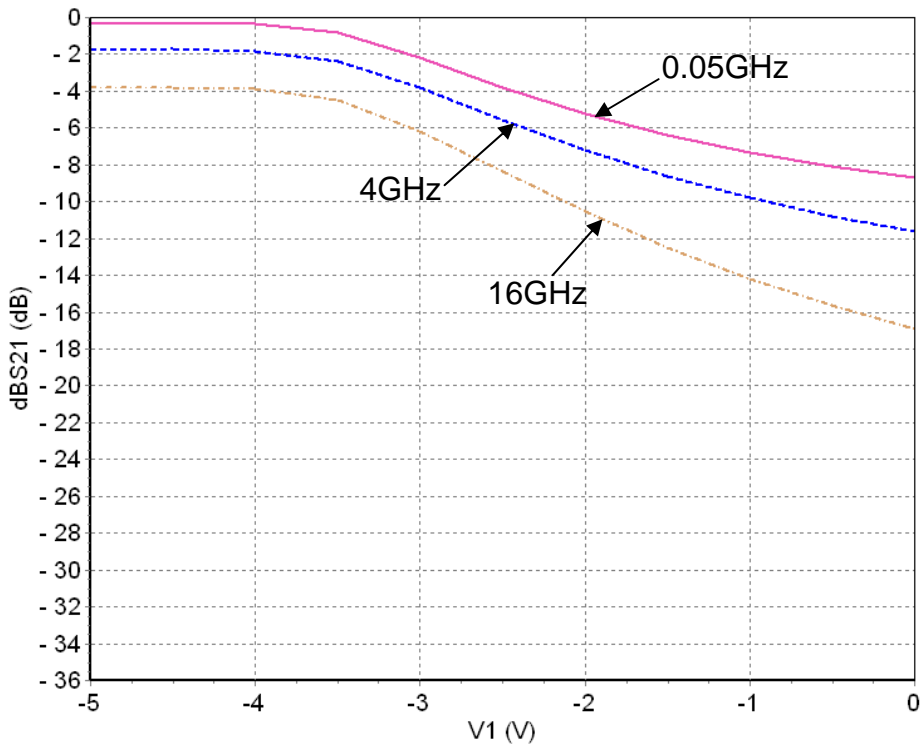

Attenuation control with V1=0V

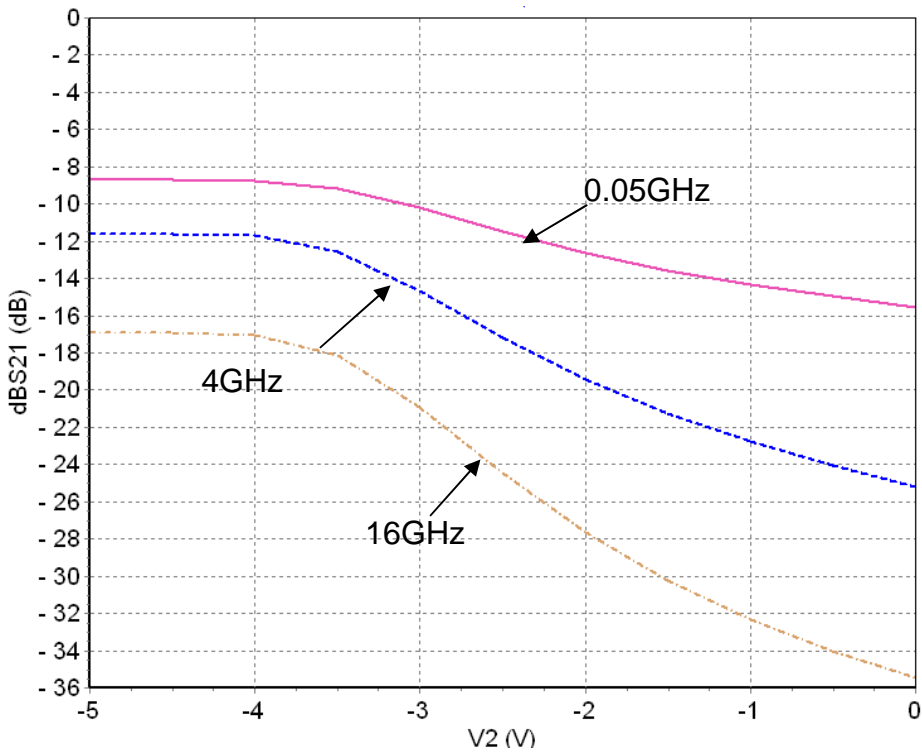

Attenuation versus input power @ 0.7GHz

V1 = -5V to 0V & V2= -5V and after V1= 0V & V2 = -5V to 0V

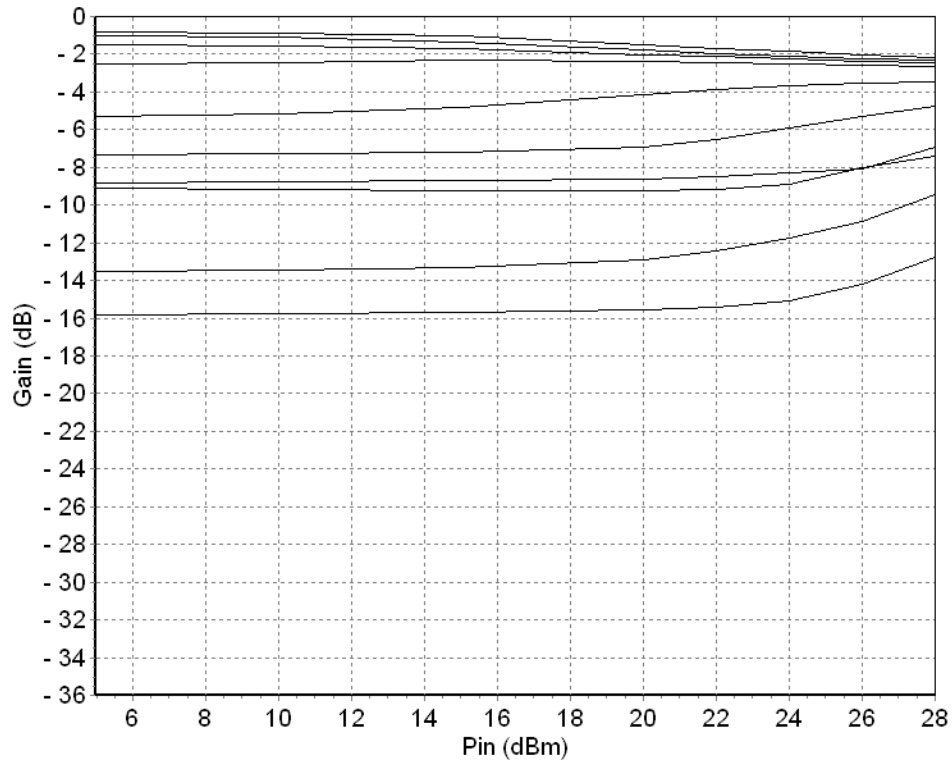

Attenuation versus input power @ 4GHz

V1 = -5V to 0V & V2= -5V and after V1= 0V & V2 = -5V to 0V

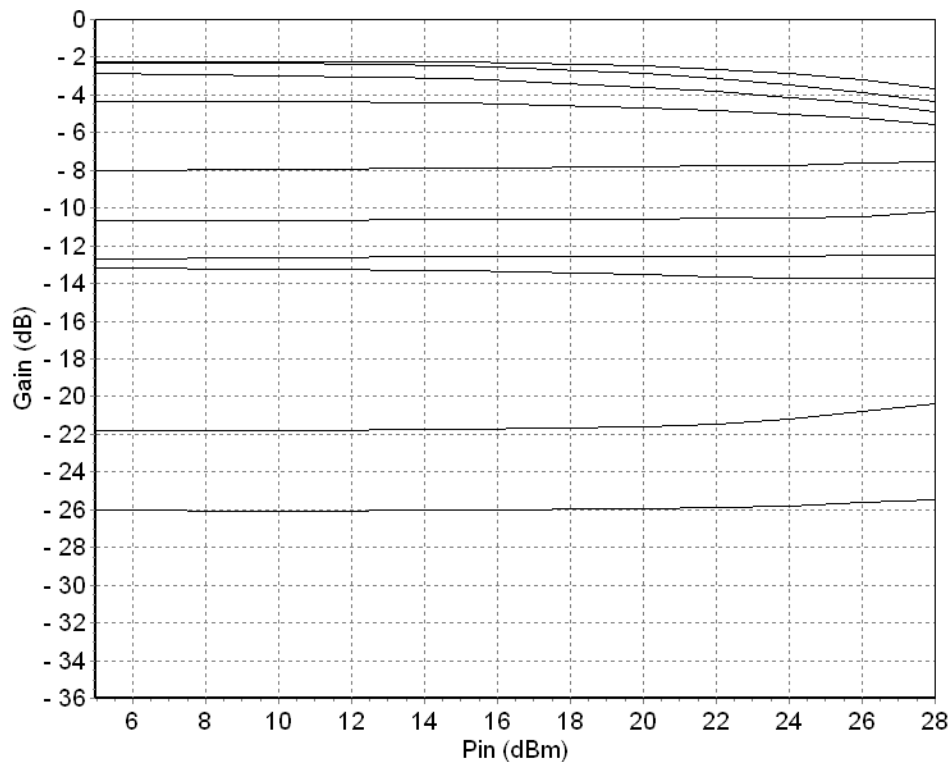

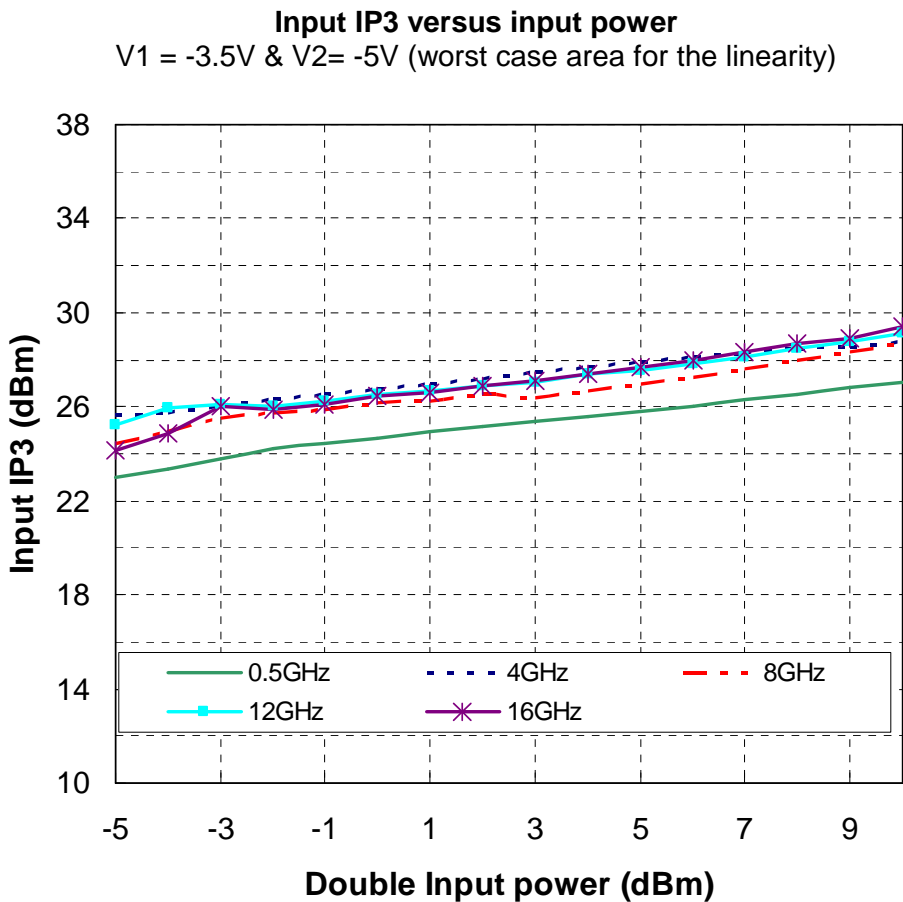
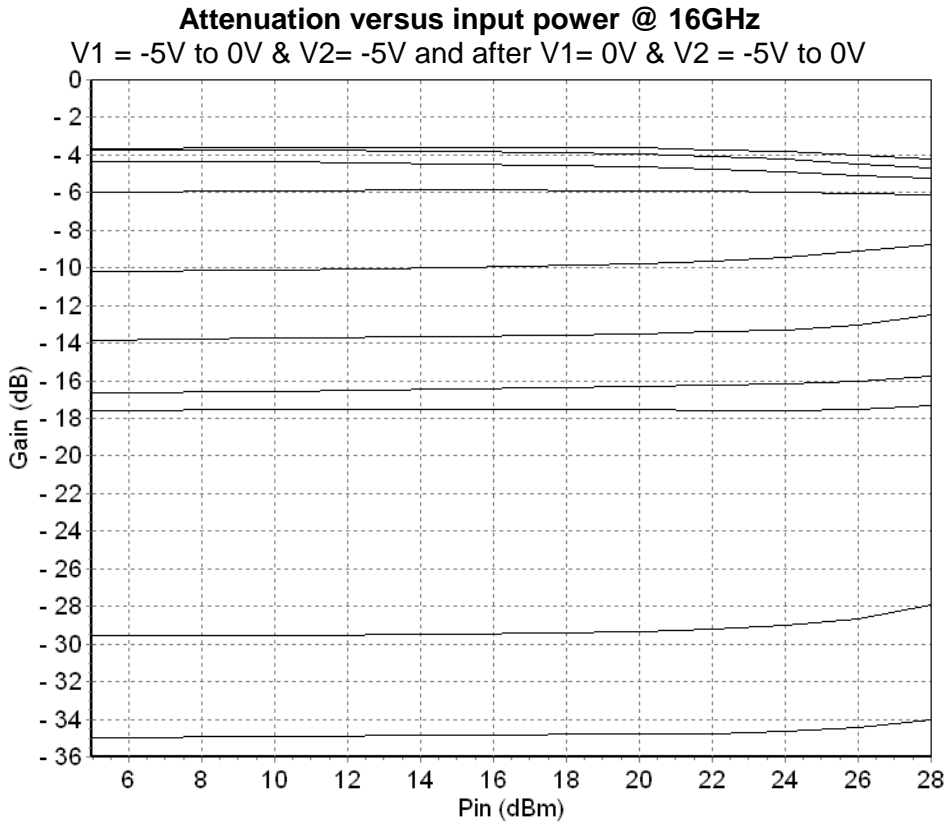

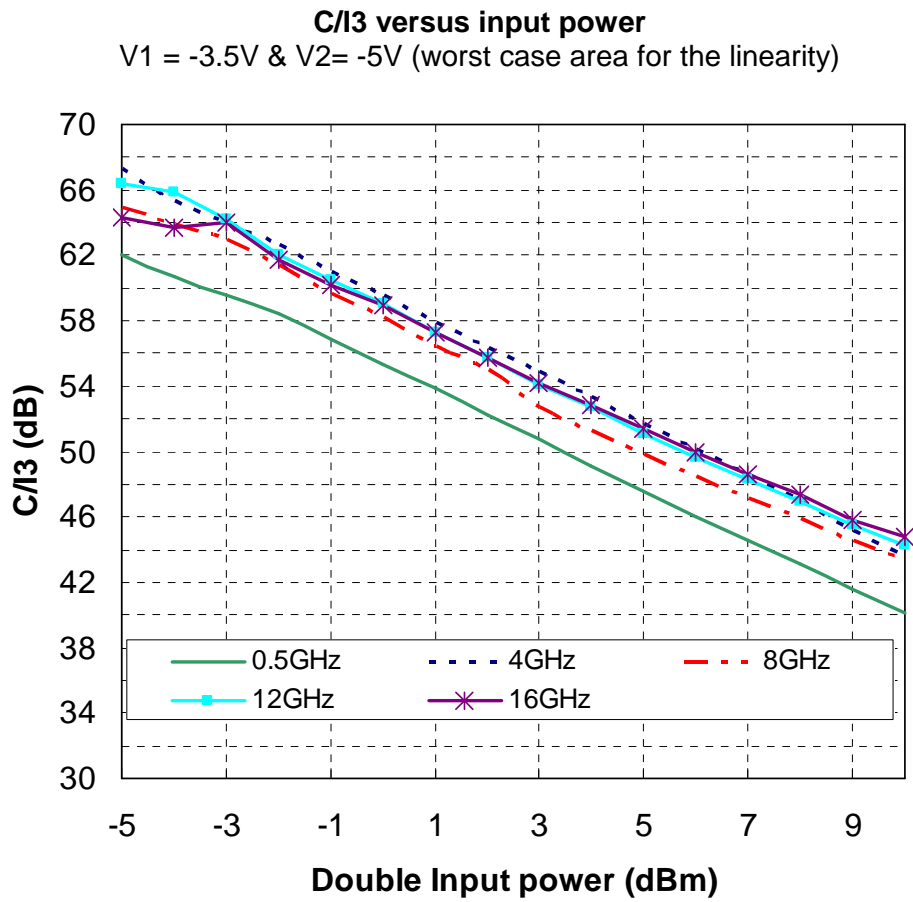

Typical Measured Performances in temperature

Measurements in the package access planes

Attenuation versus input power @ 0.7GHz

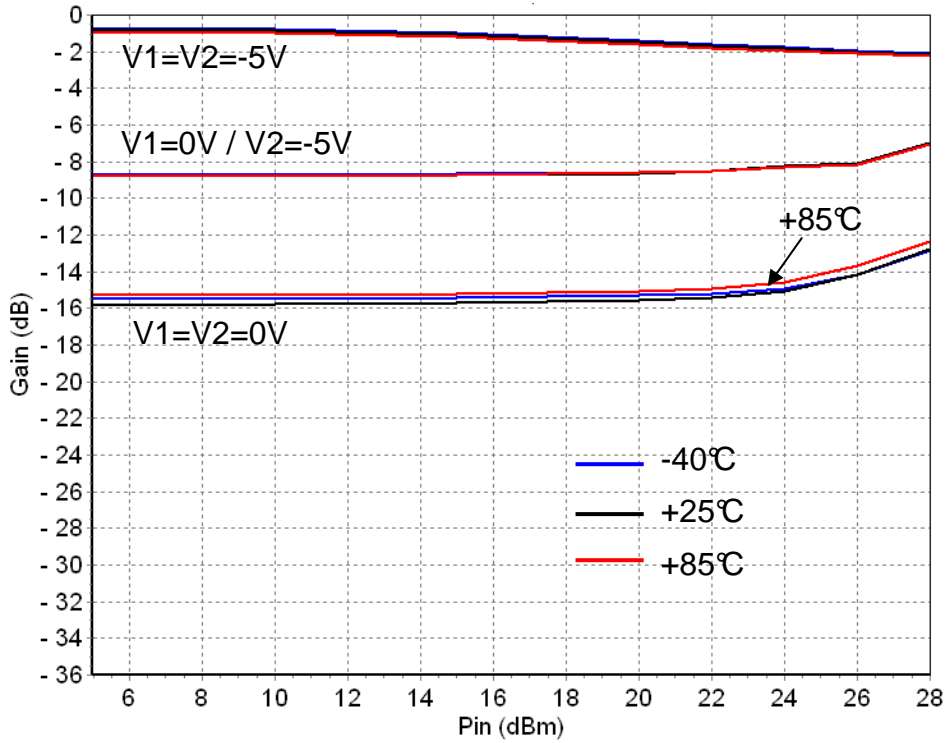

Attenuation versus input power @ 4GHz

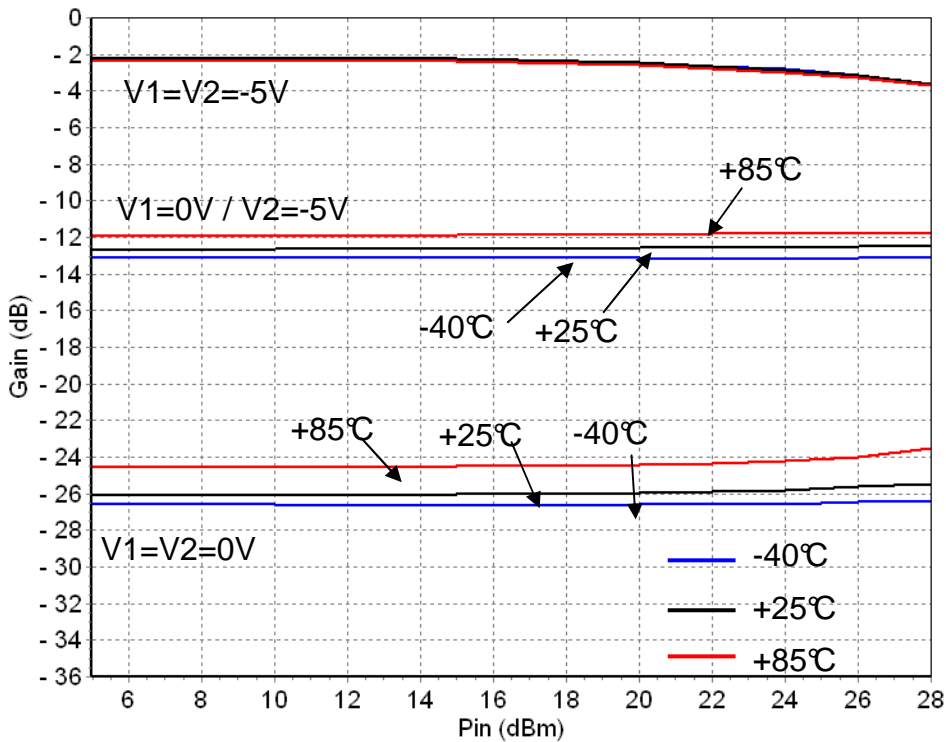

Attenuation versus input power @ 16GHz

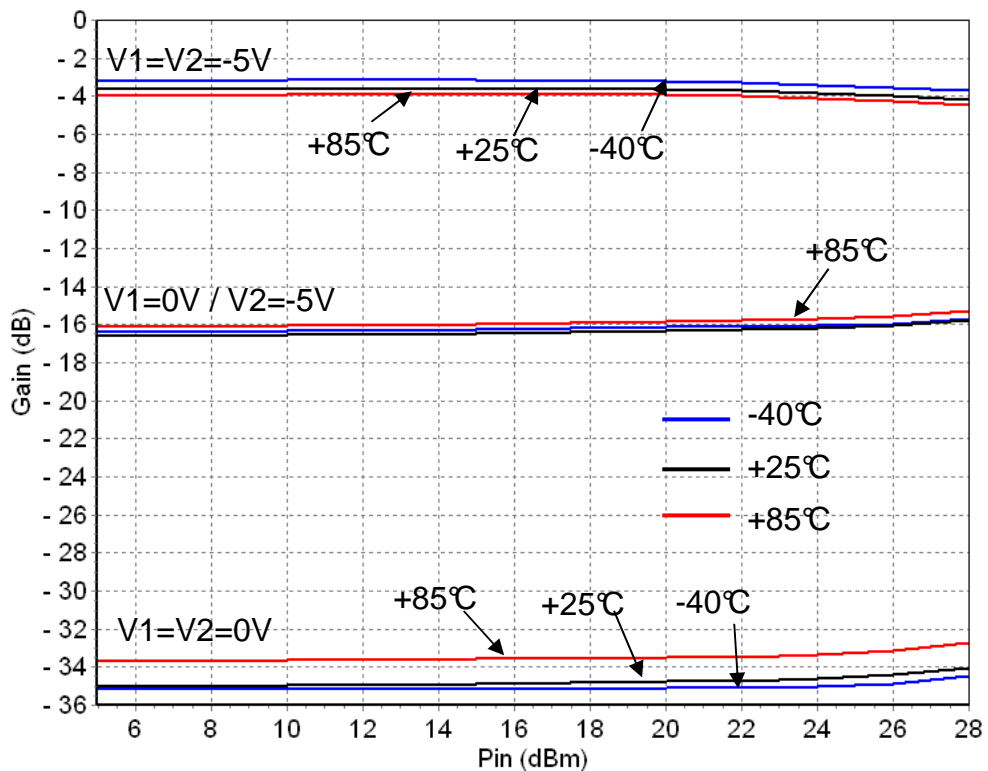

Input IP3 versus input power @ 0.5GHz

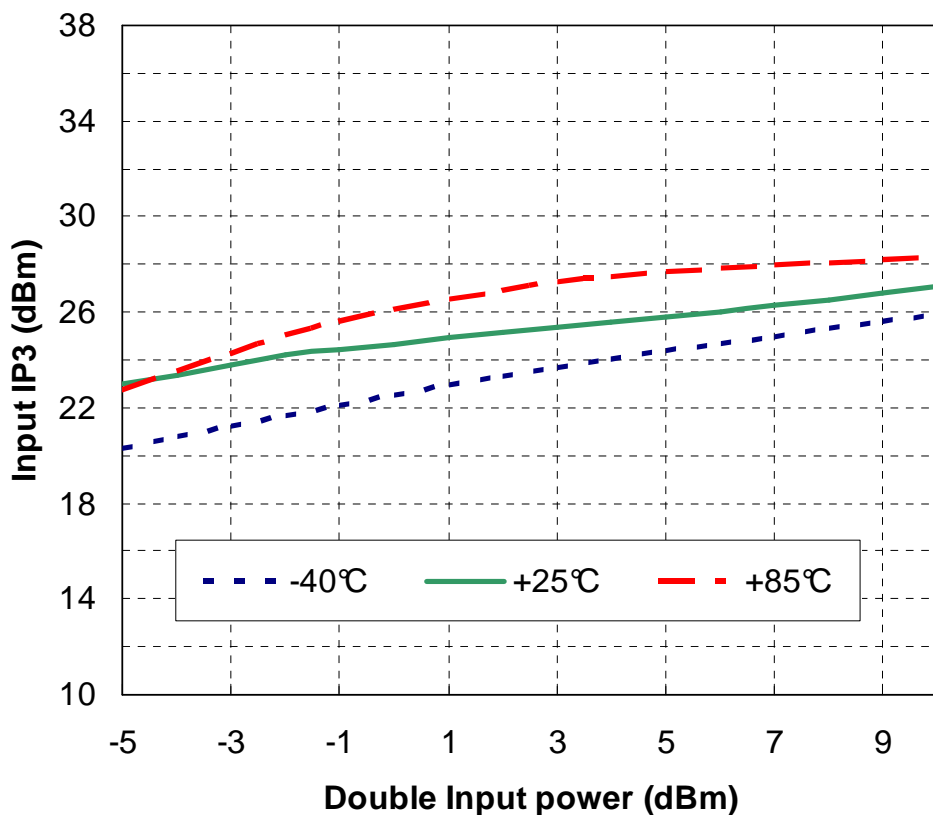

Input IP3 versus input power @ 16GHz

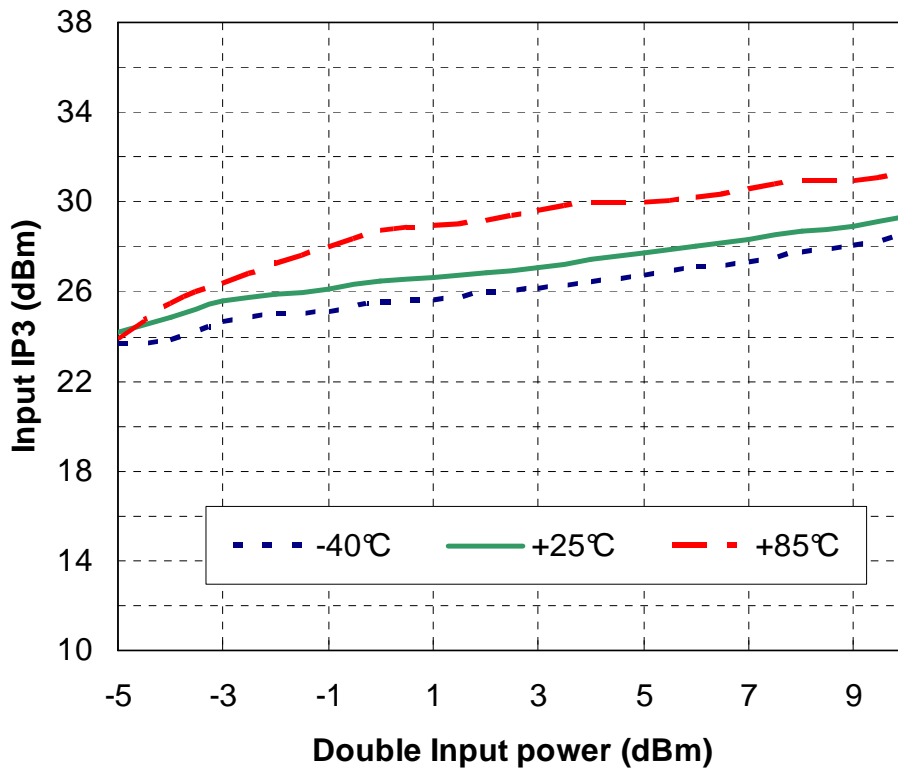

Package outline ⁽¹⁾

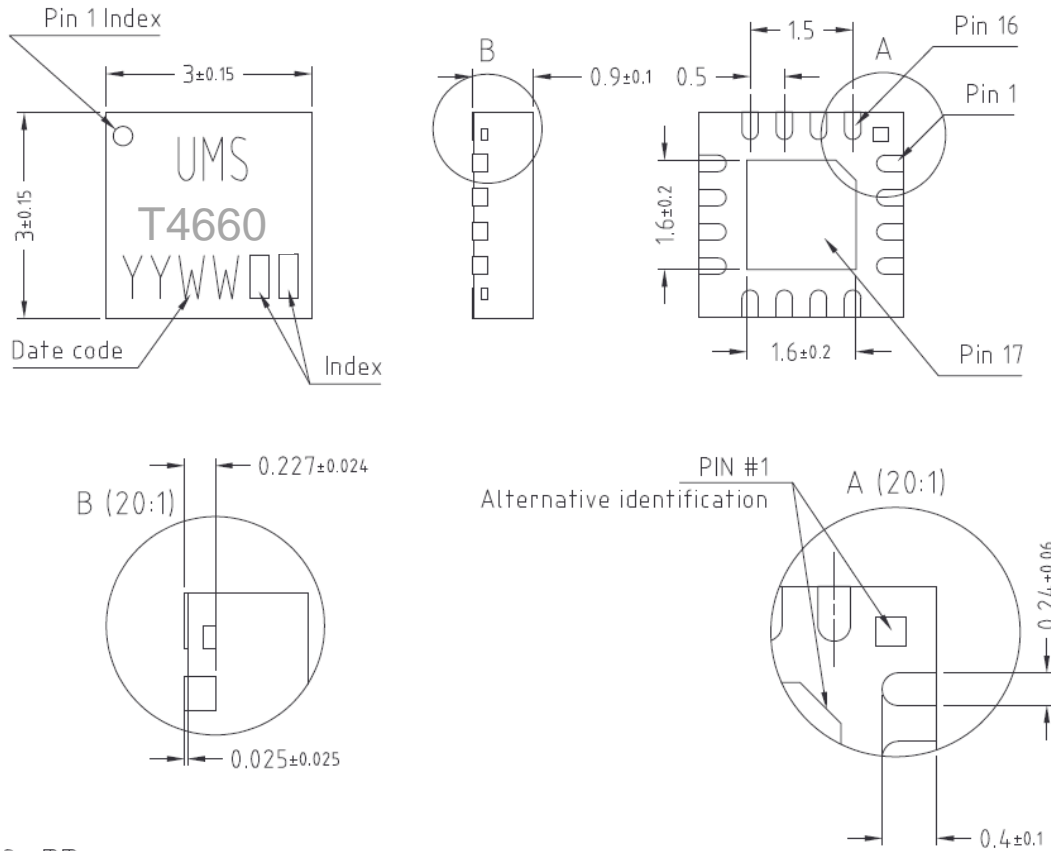

Units : mm

From the standard : JEDEC MO-220 [VEED]

Matt tin, Lead free (Green)

Matt tin, Lead Free	(Green)	1- Gnd ⁽²⁾	9- Gnd ⁽²⁾
Units	mm	2- Gnd ⁽²⁾	10- RF Out
From the standard	JEDEC MO-220 (VEED)	3- RF In	11- Gnd ⁽²⁾
		4- Gnd ⁽²⁾	12- Gnd ⁽²⁾
	17- GND	5- NC	13- NC
		6- V1	14- NC
		7- V2	15- NC
		8- NC	16- NC

⁽¹⁾The package outline drawing included to this data-sheet is given for indication. Refer to the application note AN0017 available at <http://www.ums-gaas.com> for exact package dimensions.

⁽²⁾It is strongly recommended to ground the Gnd pins on the PCB board.

Definition of the Sij reference planes

The reference planes used for Sij measurements given above are symmetrical from the symmetrical axis of the package (see drawing beside). The input and output reference planes are located at 2.65mm offset (input wise and output wise respectively) from this axis. Then, the given Sij parameters incorporate the land pattern of the evaluation motherboard recommended at the page 18.

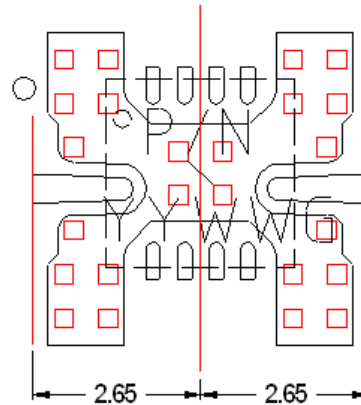

Recommended package footprint

Refer to the application note AN0017 available at <http://www.ums-gaas.com> for package footprint recommendations.

SMD mounting procedure

The SMD leadless package has been designed for high volume surface mount PCB assembly process. The dimensions and footprint required for the PCB (motherboard) are given in the drawings above.

For the mounting process standard techniques involving solder paste and a suitable reflow process can be used. For further details, see application note AN0017.

Recommended ESD management

Refer to the application note AN0020 available at <http://www.ums-gaas.com> for ESD sensitivity and handling recommendations for the UMS package products.

Recommended environmental management

Refer to the application note AN0019 available at <http://www.ums-gaas.com> for environmental data on UMS package products.

Packaged part biasing options

To obtain good performances in linearity, biasing voltage should be applied as following:

- Control of 1st stage attenuation with V1 from -5V to 0V, with V2 fixed at -5V
- Control of 2nd stage with V2 from -5V to 0V, with V1 fixed at 0V

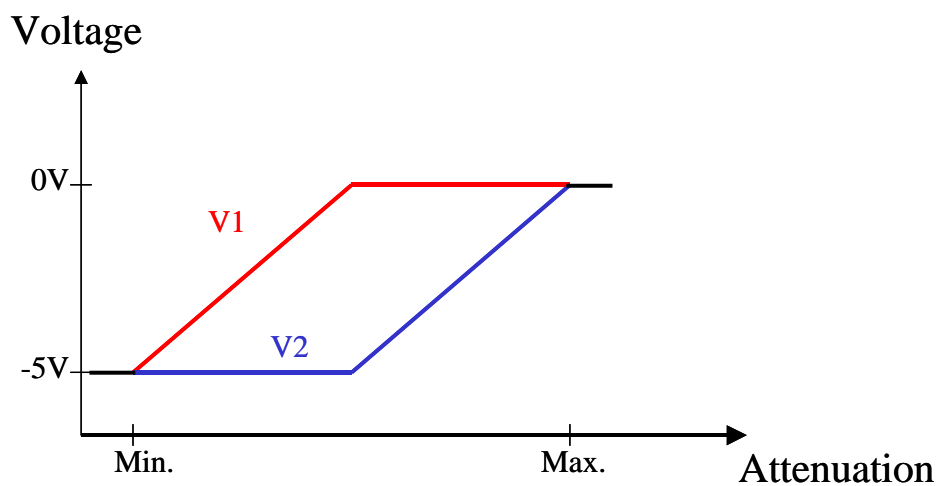
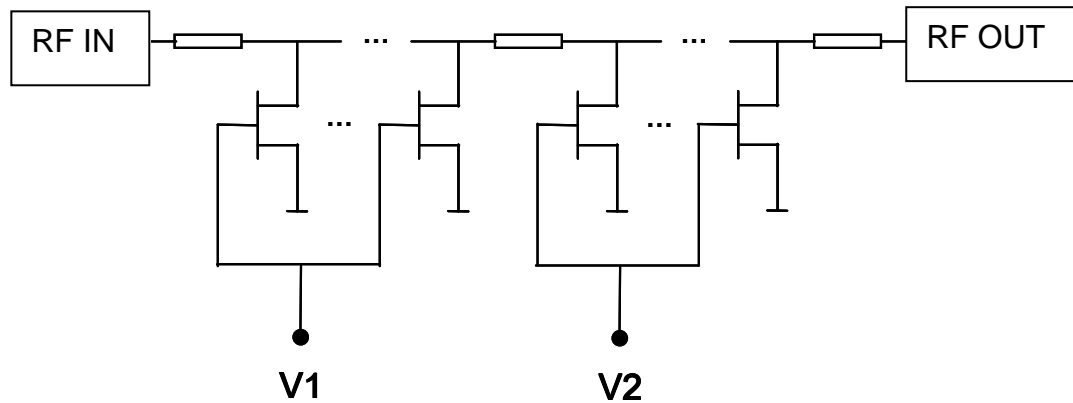

The RF ports are not DC blocked. There are no DC capacitors in the package.

Note

This part could be also driven in Single Voltage Control, applying the same voltage from -5V to 0V on V1 and V2, leading to lower linearity performances.

Evaluation mother board

- Compatible with the proposed footprint
- Based on typically Ro4003 / 8mils or equivalent
- Using a microstrip to coplanar transition to access the package
- Recommended for the implementation of this product on a module board
- Decoupling capacitors of $10\text{nF} \pm 10\%$ are recommended for all DC accesses
- (See application note AN0017 for details)

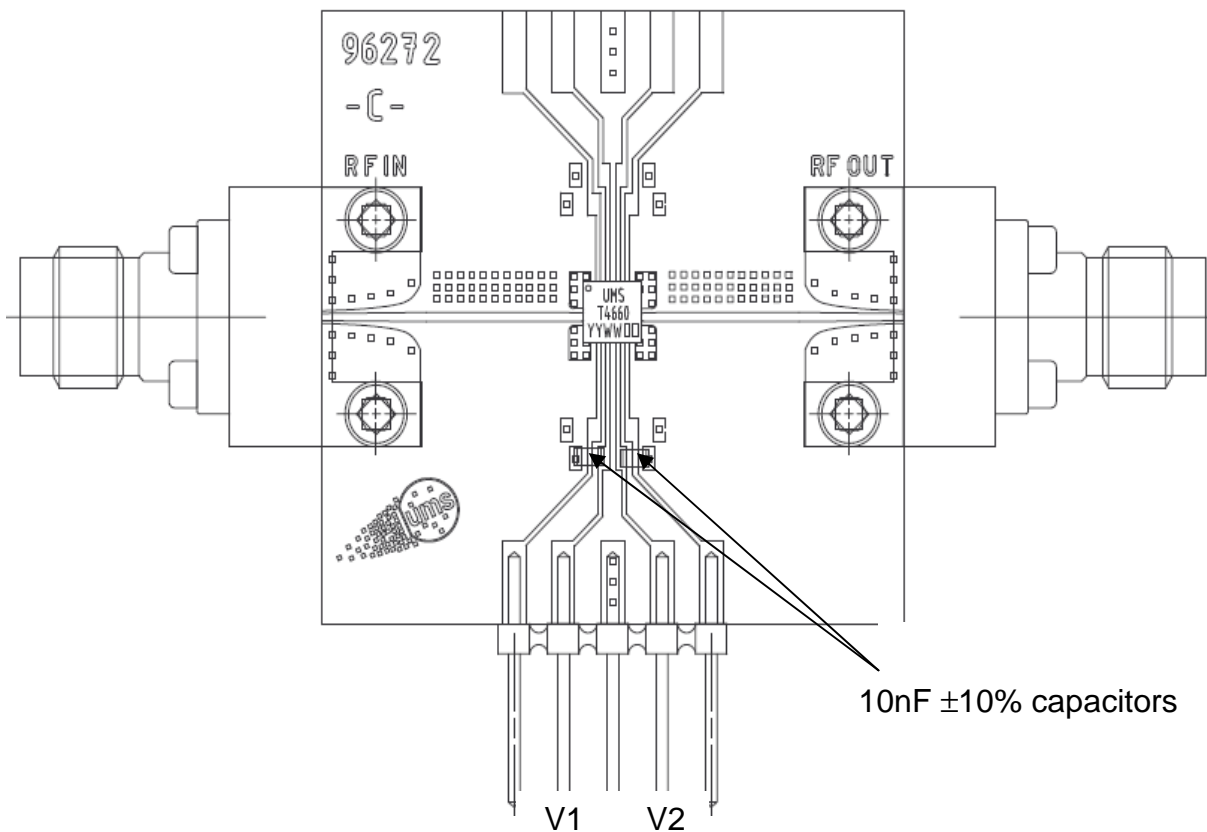

Ordering Information

QFN 3x3 RoHS compliant package:

CHT4660-QAG/XY

Stick: XY = 20

Tape & reel: XY = 21

Information furnished is believed to be accurate and reliable. However **United Monolithic Semiconductors S.A.S.** assumes no responsibility for the consequences of use of such information nor for any infringement of patents or other rights of third parties which may result from its use. No license is granted by implication or otherwise under any patent or patent rights of **United Monolithic Semiconductors S.A.S.** Specifications mentioned in this publication are subject to change without notice. This publication supersedes and replaces all information previously supplied. **United Monolithic Semiconductors S.A.S.** products are not authorised for use as critical components in life support devices or systems without express written approval from **United Monolithic Semiconductors S.A.S.**