

## 8.5-10.5GHz Phase Shifter

### GaAs Monolithic Microwave IC in SMD leadless package

#### Description

CHP3015-QDG is an X-Band (8.5-10.5GHz) monolithic 6-bit digital phase-shifter with a 0-360° range and high phase accuracy. The average RMS phase error is 4°. The circuit provides 8dB insertion loss associated with input and output return losses better than 10dB under all states. An on-chip DC-interface is compatible with both CMOS (0/+3.3V) and TTL (0/+5V) logics.

The circuit is mainly dedicated to defense and space systems and is also well suited for a wide range of microwave applications.

The MMIC is developed on a robust 0.25µm gate length pHEMT process and is packaged in a standard surface mount 24-lead QFN4x4.

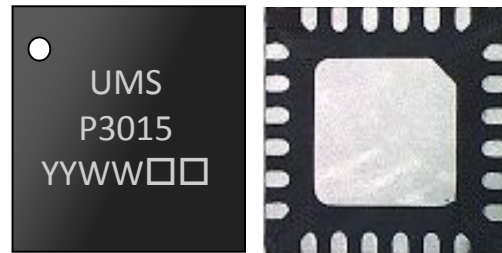

#### Main Features

- 4 deg average RMS phase error
- I/O return losses > 10dB at all states
- 23.5dBm Input P1dB
- CMOS/TTL compatibility: V+ = +3.3/5V
- DC-decoupled I/O
- 24L-QFN4x4
- MSL1

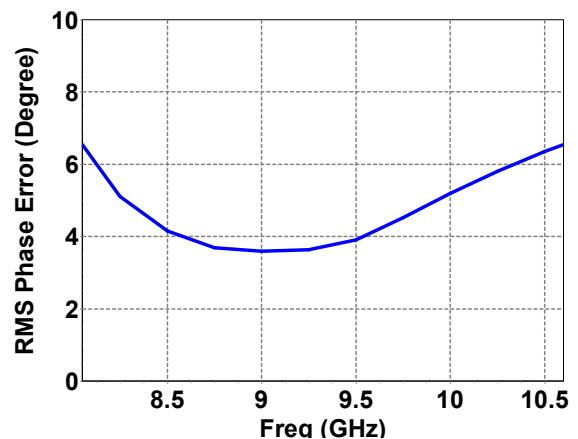

#### Main Electrical Characteristics

Tamb. = +25°C

Symbol	Parameter	Min	Typ	Max	Unit
Freq	Frequency range	8.5		10.5	GHz
PPE	Peak Phase Error		(-2, +8)		deg
RMS_PE	RMS Phase Error		4		deg

**Electrical Characteristics**

Temperature= +25°C

<b>Symbol</b>	<b>Parameter</b>	<b>Min</b>	<b>Typ</b>	<b>Max</b>	<b>Unit</b>
Freq	Frequency range	8.5		10.5	GHz
PhS	Phase Shifting Range	0		360	deg
PhS step	Phase Shifting Step		5.625		deg
PPE	Peak Phase Error		(-2, +8)		deg
RMS_PE	RMS Phase Error		4		deg
IL	Insertion Loss		8		dB
Av	Amplitude Variation		(-0.75, +1.5)		dB
RMS_Av	RMS Amplitude Variation		0.6		dB
VSWR_In	Input Return Loss		10		dB
VSWR_Out	Output Return Loss		10		dB
P1dB	Input power @ 1dBcomp		23.5		dBm
OP1dB	Output power @ 1dBcomp		16.5		dBm
Vlow	Control Voltage – low level	0		0.4	V
Vhigh	Control Voltage – high level	2.4		6	V
V+	Positive Supply Voltage		5 or 3.3		V
V-	Negative Supply Voltage		-5		V
I+	Positive Supply Current		4		mA
I-	Negative Supply Current		3.5		mA

These values are representative of on-board measurements as defined on the drawing in paragraph "Evaluation mother board"

**Peak Phase Error (PPE) definition**

$PPE(i) = \text{measured\_Phase}(S21)@state(i) - \text{measured\_Phase}(S21)@state(0) - \text{theoreticalPhaseValue}@State(i)$

**Amplitude Variation (Av) definition**

$Av(i) = \text{Measured\_dB}(S21)@state(i) - \text{Measured\_dB}(S21)@state(0)$

**RMS Phase Error (RMS\_PE) definition**

$$RMS\_PE = \sqrt{\frac{\sum_{i=0}^{63} PPE^2(i)}{64}}$$

where i is the state number (from 0 to 63)

**RMS Amplitude variation (RMS\_Av) definition**

$$RMS\_AV = \overline{Av} = \frac{\sum_{i=0}^{63} Av(i)}{64}$$

where i is the state number (from 0 to 63)

**Absolute Maximum Ratings <sup>(1)</sup>**

Temperature= +25°C

Symbol	Parameter	Values	Unit
V+	Maximum DC positive supply voltage	+6	V
V-	Maximum DC negative supply voltage	-6	mA
Vlow	Minimum phase shifter control voltage	-2	V
Vhigh	Maximum phase shifter control voltage	+6	V
Tj	Junction temperature	175	°C
Ta	Operating temperature range	-40 to +85	°C
Tstg	Storage temperature range	-55 to +150	°C

<sup>(1)</sup> Operation of this device above anyone of these parameters may cause permanent damage.

**Typical Bias Conditions**

Two options are possible for the positive value of the biasing circuit without impact on the RF performances.

## Option 1

<b>Symbol</b>	<b>PIN N°</b>	<b>Parameter</b>	<b>Values</b>	<b>Unit</b>
V+	21	Positive Supply Voltage	+5	V
V-	19	Negative Supply Voltage	-5	V
V+	20	Positive Supply Voltage	NC	
Bit1 to Bit6	18 to 13	Control Voltage	0 / +3.3	V

## Option 2

<b>Symbol</b>	<b>PIN N°</b>	<b>Parameter</b>	<b>Values</b>	<b>Unit</b>
V+	21	Positive Supply Voltage	+3.3	V
V-	19	Negative Supply Voltage	-5	V
V+	20	Positive Supply Voltage	+3.3	V
Bit1 to Bit6	18 to 13	Control Voltage	0 / +3.3	V

### Phase shifter control table

Voltages to apply on Bit 1 to Bit 6 (pins #18 to #13)

State	Phase (deg)	Bit 6	Bit 5	Bit 4	Bit 3	Bit 2	Bit 1	State	Phase (deg)	Bit 6	Bit 5	Bit 4	Bit 3	Bit 2	Bit 1
0	0	0	0	0	0	0	0	32	180	3.3	0	0	0	0	0
1	5.625	0	0	0	0	0	3.3	33	185.625	3.3	0	0	0	0	3.3
2	11.25	0	0	0	0	3.3	0	34	191.25	3.3	0	0	0	3.3	0
3	16.875	0	0	0	0	3.3	3.3	35	196.875	3.3	0	0	0	3.3	3.3
4	22.5	0	0	0	3.3	0	0	36	202.5	3.3	0	0	3.3	0	0
5	28.125	0	0	0	3.3	0	3.3	37	208.125	3.3	0	0	3.3	0	3.3
6	33.75	0	0	0	3.3	3.3	0	38	213.75	3.3	0	0	3.3	3.3	0
7	39.375	0	0	0	3.3	3.3	3.3	39	219.375	3.3	0	0	3.3	3.3	3.3
8	45	0	0	3.3	0	0	0	40	225	3.3	0	3.3	0	0	0
9	50.625	0	0	3.3	0	0	3.3	41	230.625	3.3	0	3.3	0	0	3.3
10	56.25	0	0	3.3	0	3.3	0	42	236.25	3.3	0	3.3	0	3.3	0
11	61.875	0	0	3.3	0	3.3	3.3	43	241.875	3.3	0	3.3	0	3.3	3.3
12	67.5	0	0	3.3	3.3	0	0	44	247.5	3.3	0	3.3	3.3	0	0
13	73.125	0	0	3.3	3.3	0	3.3	45	253.125	3.3	0	3.3	3.3	0	3.3
14	78.75	0	0	3.3	3.3	3.3	0	46	258.75	3.3	0	3.3	3.3	3.3	0
15	84.375	0	0	3.3	3.3	3.3	3.3	47	264.375	3.3	0	3.3	3.3	3.3	3.3
16	90	0	3.3	0	0	0	0	48	270	3.3	3.3	0	0	0	0
17	95.625	0	3.3	0	0	0	3.3	49	275.625	3.3	3.3	0	0	0	3.3
18	101.25	0	3.3	0	0	3.3	0	50	281.25	3.3	3.3	0	0	3.3	0
19	106.875	0	3.3	0	0	3.3	3.3	51	286.875	3.3	3.3	0	0	3.3	3.3
20	112.5	0	3.3	0	3.3	0	0	52	292.5	3.3	3.3	0	3.3	0	0
21	118.125	0	3.3	0	3.3	0	3.3	53	298.125	3.3	3.3	0	3.3	0	3.3
22	123.75	0	3.3	0	3.3	3.3	0	54	303.75	3.3	3.3	0	3.3	3.3	0
23	129.375	0	3.3	0	3.3	3.3	3.3	55	309.375	3.3	3.3	0	3.3	3.3	3.3
24	135	0	3.3	3.3	0	0	0	56	315	3.3	3.3	3.3	0	0	0
25	140.625	0	3.3	3.3	0	0	3.3	57	320.625	3.3	3.3	3.3	0	0	3.3
26	146.25	0	3.3	3.3	0	3.3	0	58	326.25	3.3	3.3	3.3	0	3.3	0
27	151.875	0	3.3	3.3	0	3.3	3.3	59	331.875	3.3	3.3	3.3	0	3.3	3.3
28	157.5	0	3.3	3.3	3.3	0	0	60	337.5	3.3	3.3	3.3	3.3	0	0
29	163.125	0	3.3	3.3	3.3	0	3.3	61	343.125	3.3	3.3	3.3	3.3	0	3.3
30	168.75	0	3.3	3.3	3.3	3.3	0	62	348.75	3.3	3.3	3.3	3.3	3.3	0
31	174.375	0	3.3	3.3	3.3	3.3	3.3	63	354.375	3.3	3.3	3.3	3.3	3.3	3.3

## Typical OWT Board Measurements

Temperature= +25°C, V+ = +5V, V- = -5V

### Insertion Loss versus frequency at all states

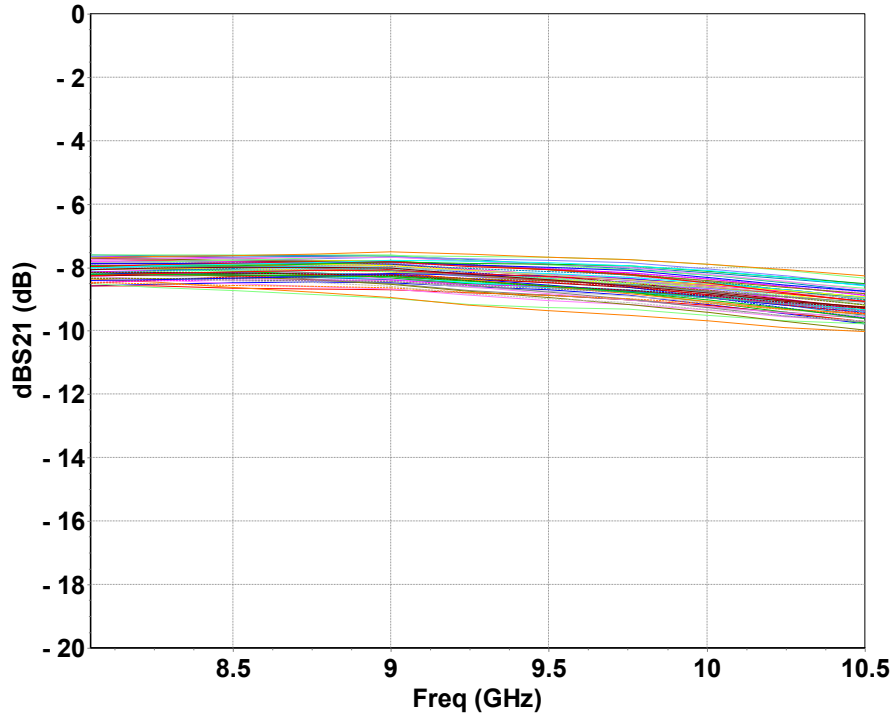

### |S11| versus frequency at all states

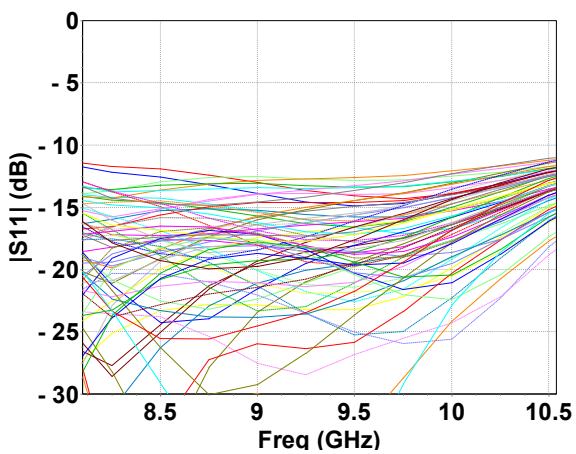

### |S22| versus frequency at all states

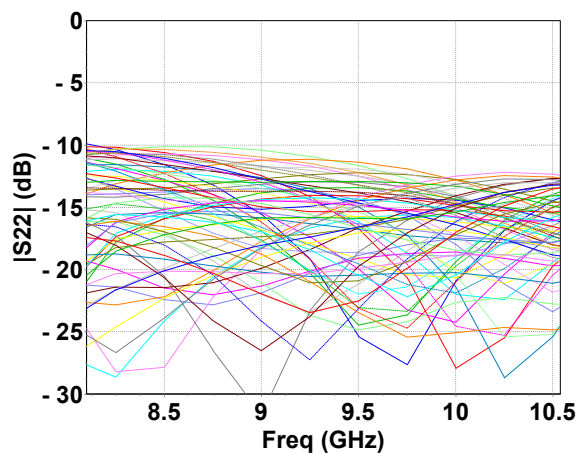

**Typical Board Measurements**

Temperature= +25°C, V+ = +5V, V- = -5V

**Peak Phase Error versus frequency  
(all states)**

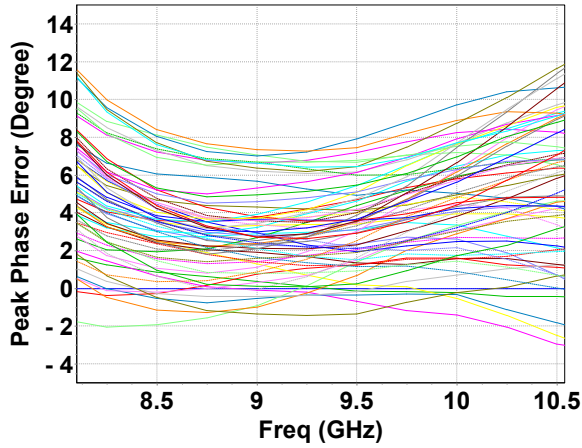

**Peak Phase Error versus state**

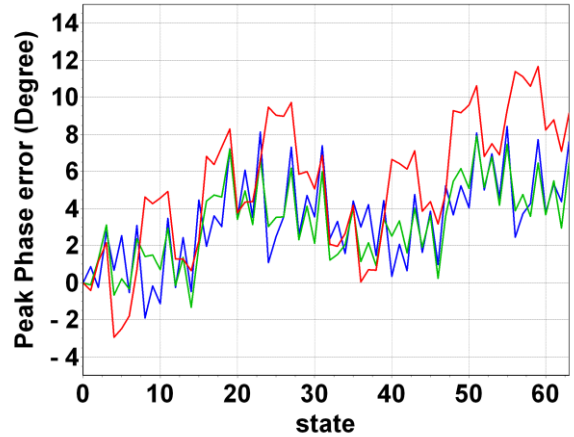

— 8.5GHz — 9.5GHz — 10.5GHz

**RMS Phase Error versus frequency**

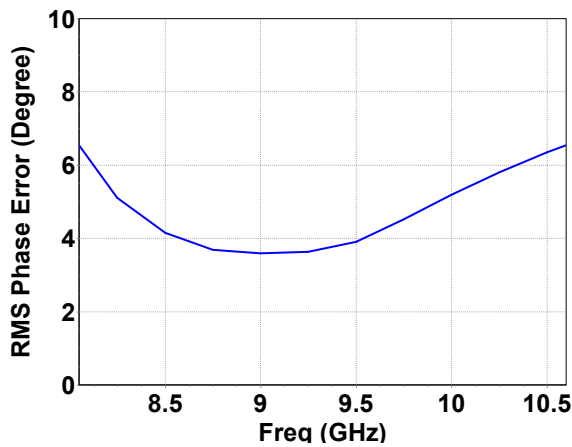

**Phase Shift versus state  
@ 9.5GHz**

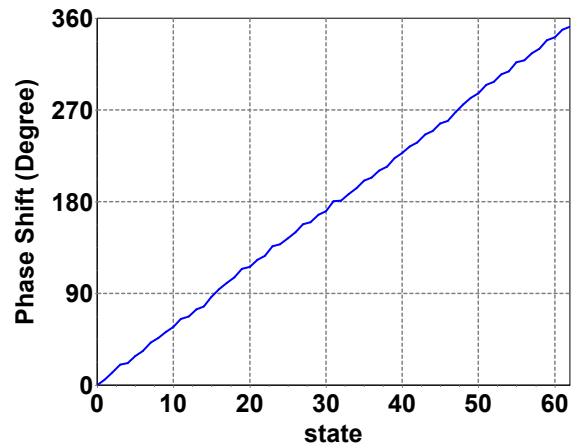

## Typical Board Measurements

Temperature= +25°C, V+ = +5V, V- = -5V

**Amplitude Variation versus Frequency  
(all states)**

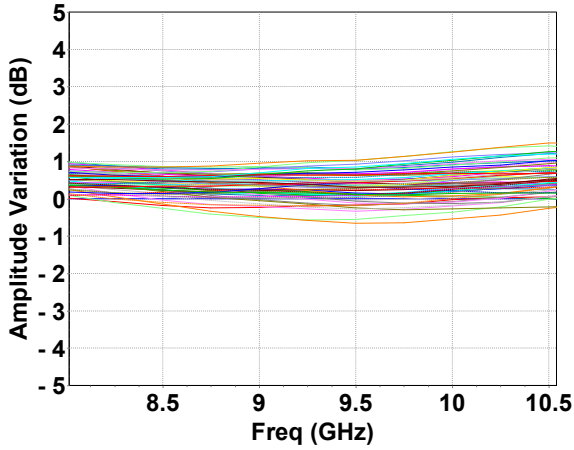

**Amplitude Variation versus State**

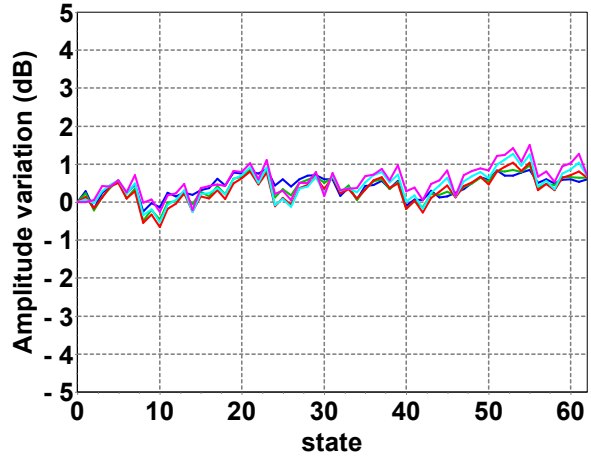

— 8.5GHz — 9 GHz — 9.5GHz — 10GHz  
— 10.5GHz

**RMS Amplitude Variation versus frequency**

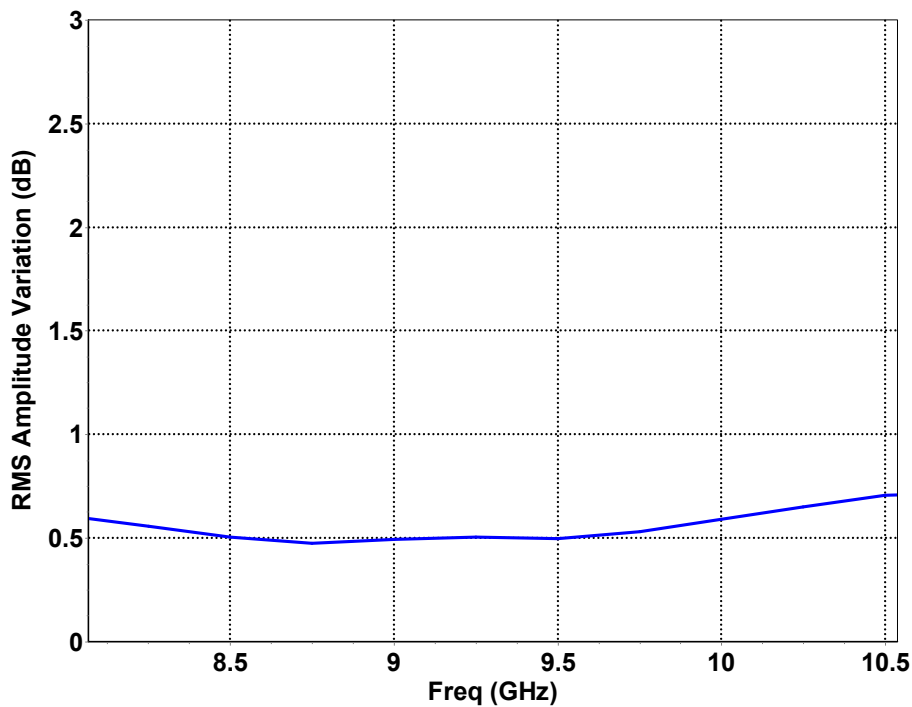



**Typical OWT Board Measurements**

Temperature= +25°C, V+ = +5V, V- = -5V

Input power @1dB compression (all states)

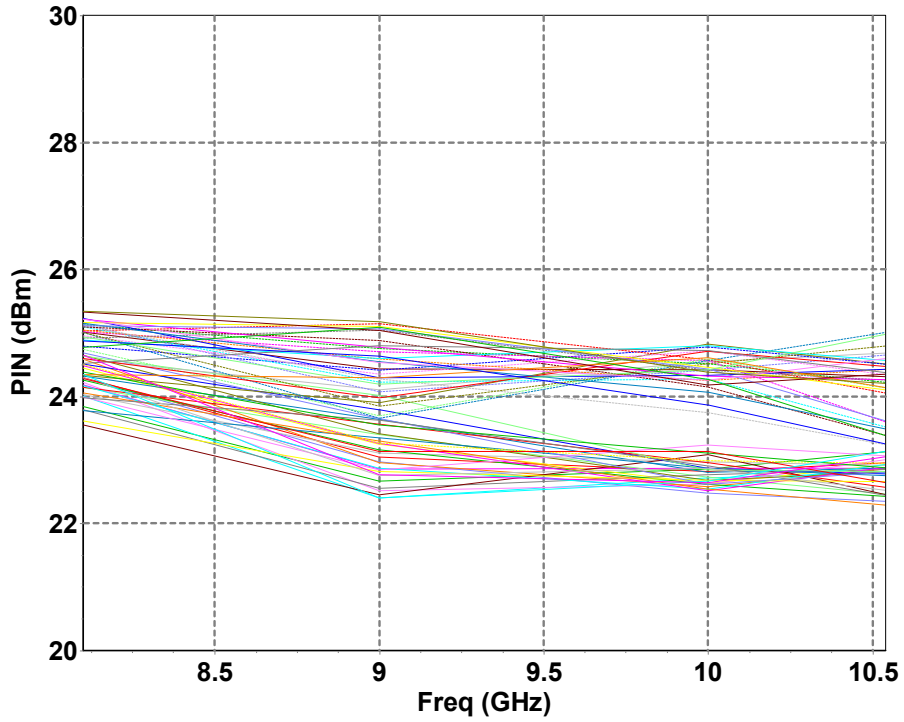

## Package outline <sup>(1)</sup>

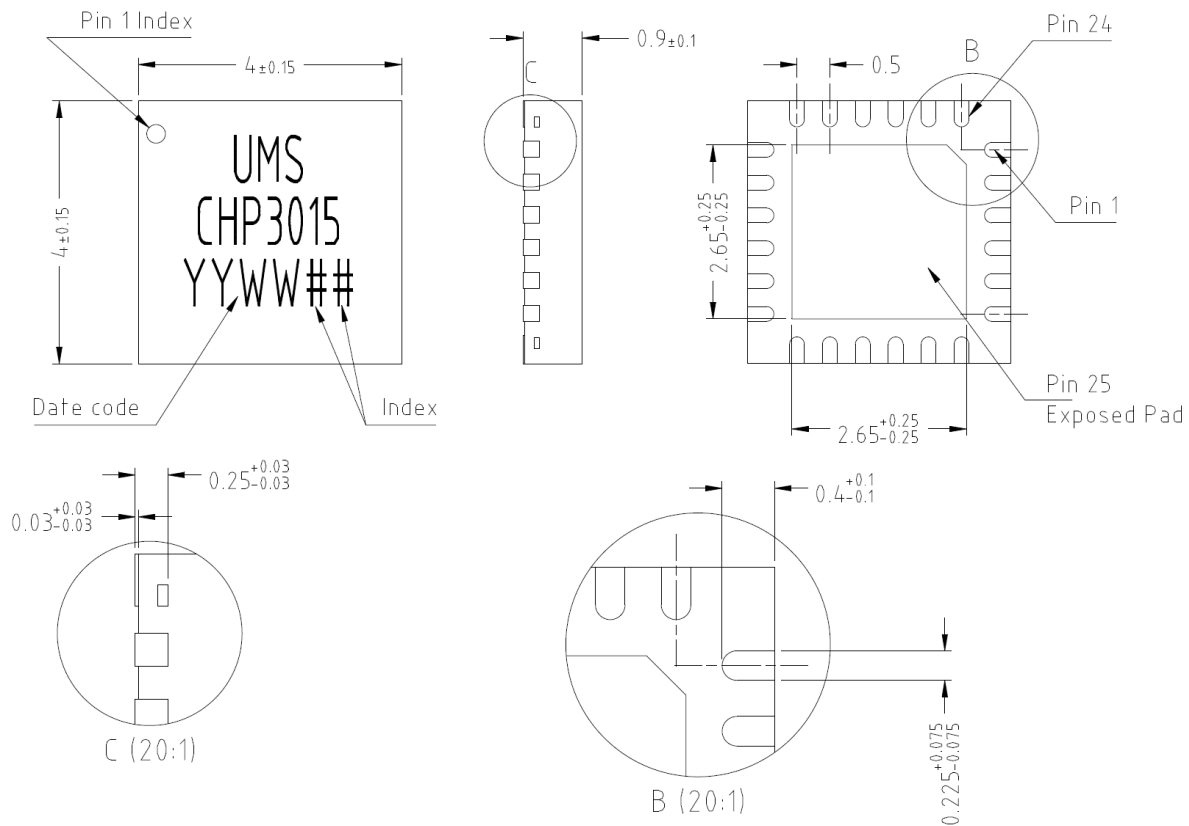

Matt tin, Lead Free	(Green)	1- Nc	11- Nc	21- +5V
Units :	mm	2- Nc	12- Nc	22- Nc
From the standard :	JEDEC MO-220	3- Nc	13- B6	23- Gnd <sup>(2)</sup>
	(VGGD)	4- Nc	14- B5	24- RF out
	25- GND	5- Nc	15- B4	25- Nc
		6- Nc	16- B3	
		7- RF in	17- B2	
		8- Gnd <sup>(2)</sup>	18- B1	
		9- Nc	19- -5V	
		10- Nc	20- +3V	

<sup>(1)</sup> The package outline drawing included to this data-sheet is given for indication. Refer to the application note AN0017 (<http://www.ums-gaas.com>) for exact package dimensions.

<sup>(2)</sup> It is strongly recommended to ground all pins marked "Gnd" through the PCB board. Ensure that the PCB board is designed to provide the best possible ground to the package.

## Definition of the Sij reference planes

The reference planes used for Sij measurements given above are symmetrical from the symmetrical axis of the package (see drawing beside). The input and output reference planes are located at 3.18mm offset (input wise and output wise respectively) from this axis. Then, the given Sij parameters incorporate the land pattern of the evaluation motherboard recommended in paragraph "Evaluation motherboard".

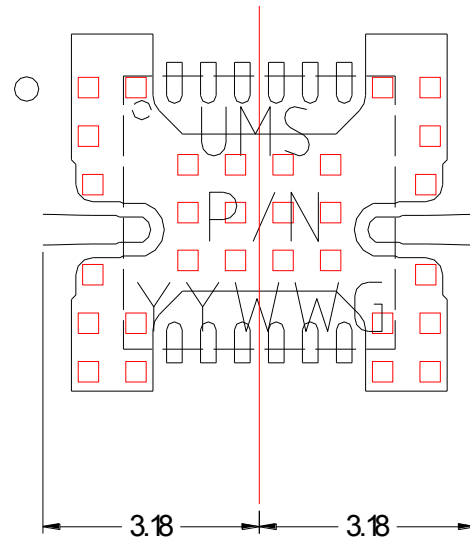

## Package Information

Parameter	Value
Package body material	RoHS-compliant
	Low stress Injection Molded Plastic
Lead finish	100% matt Sn
MSL Rating	MSL1

## Evaluation mother board

- Compatible with the proposed footprint.
- Based on typically Ro4003 / 8mils or equivalent.
- Using a micro-strip to coplanar transition to access the package.
- Recommended for the implementation of this product on a module board.
- Decoupling capacitors of 100pF  $\pm$ 10% are recommended for all DC accesses.
- See application note AN0017 for details.

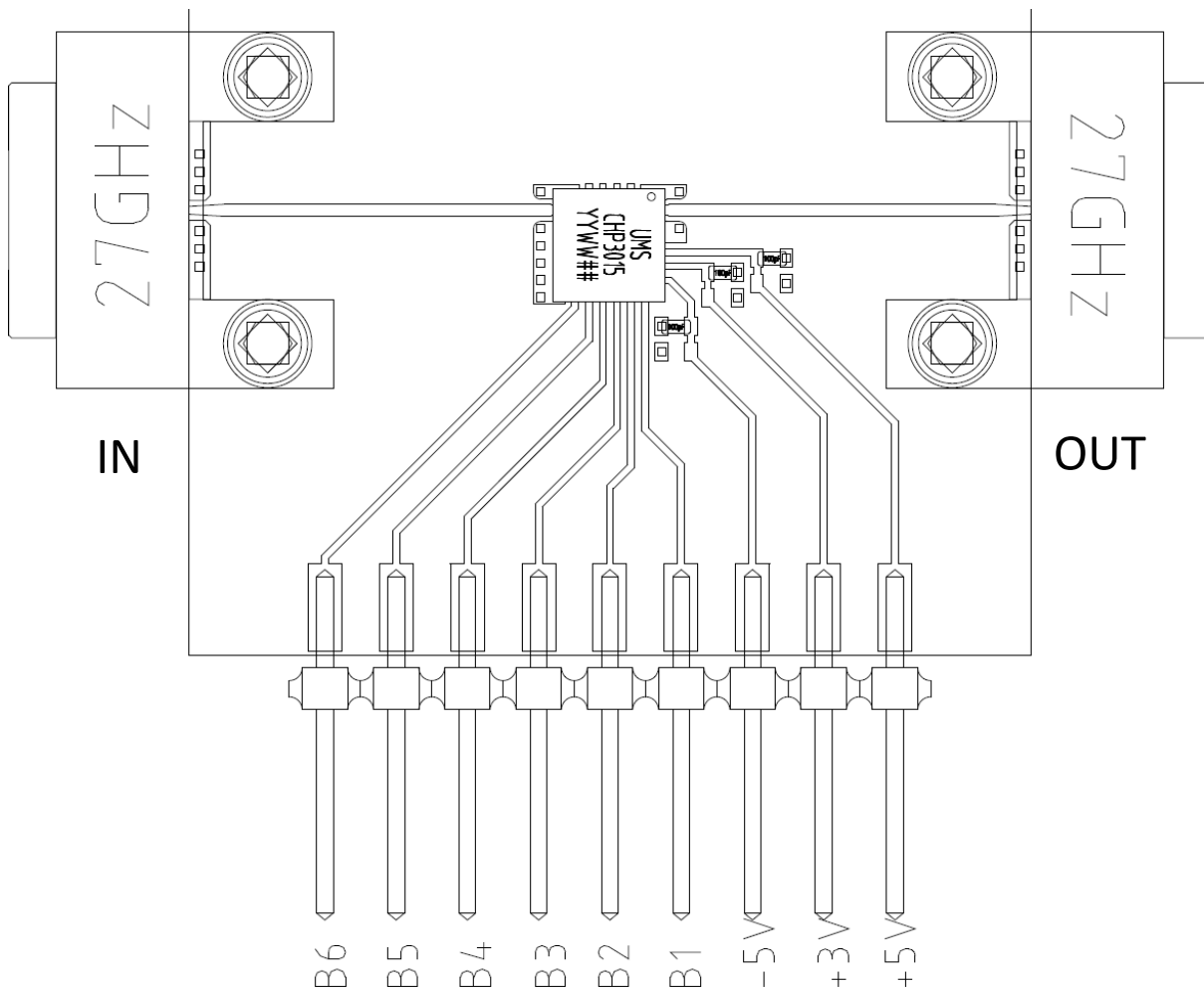

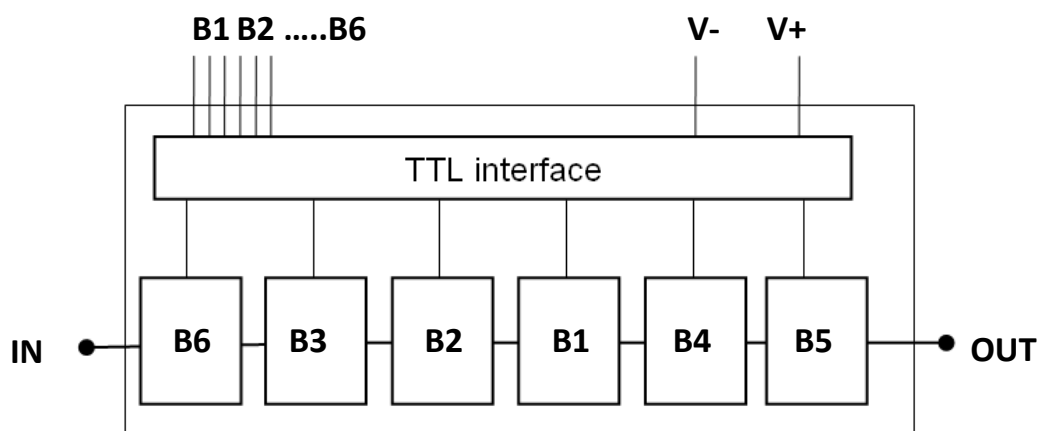
**Notes**

No ESD protections are implemented at the interface accesses.

The DC connections do not include any decoupling capacitor in package, nevertheless it is not mandatory to provide external DC decoupling on the PC board.

## Recommended package footprint

Refer to the application note AN0017 available at <http://www.ums-gaas.com> for package footprint recommendations.

## SMD mounting procedure

For the mounting process standard techniques involving solder paste and a suitable reflow process can be used. For further details, see application note AN0017.

## Recommended environmental management

UMS products are compliant with the regulation in particular with the directives RoHS N°2011/65 and REACH N°1907/2006. More environmental data are available in the application note AN0019 also available at <http://www.ums-gaas.com>.

## Recommended ESD management

Refer to the application note AN0020 available at <http://www.ums-gaas.com> for ESD sensitivity and handling recommendations for the UMS package products.

## Ordering Information

QFN 4x4 package:

CHP3015-QDG

Stick: XY = 20

Tape & reel: XY = 21

Information furnished is believed to be accurate and reliable. However **United Monolithic Semiconductors S.A.S.** assumes no responsibility for the consequences of use of such information nor for any infringement of patents or other rights of third parties which may result from its use. No license is granted by implication or otherwise under any patent or patent rights of **United Monolithic Semiconductors S.A.S.** Specifications mentioned in this publication are subject to change without notice. This publication supersedes and replaces all information previously supplied. **United Monolithic Semiconductors S.A.S.** products are not authorised for use as critical components in life support devices or systems without express written approval from **United Monolithic Semiconductors S.A.S.**