



# Military COTS 28V<sub>IN</sub> Filter

## MVA-FIAM9

### Input Attenuator Module

#### Features & Benefits

- EMI filtering-MIL-STD-461E <sup>[a]</sup>
- Transient protection
  - MIL-STD-704A/E/F
  - MIL-STD-1275A/B/D
- Environments
  - MIL-STD-810
  - MIL-STD-202
- Environmental stress screening
- Output power up to 500W
- Output current up to 18A
- Inrush current limiting
- Cold plate mounting

#### Absolute Maximum Rating

Parameter	Rating	Unit	Notes
+IN to -IN	36	V <sub>DC</sub>	Continuous
	100	V <sub>DC</sub>	50ms, See Fig.1
	250	V <sub>DC</sub>	70µs

#### MTBF per MIL-HDBK-217F (MVA-FIAM9M)

Temperature	Environment	MTBF	Unit
25°C	Ground Benign: G.B.	3,379	1,000Hrs
50°C	Naval Sheltered: N.S.	608	1,000Hrs
65°C	Airborne Inhabited Cargo: A.I.C.	476	1,000Hrs

#### Product Highlights

The MVA-FIAM9 is a DC front-end module that provides EMI filtering and transient protection. The MVA-FIAM9 enables designers using Vicor's Maxi, Mini, Micro Series 24V & Maxi Series 28V DC-DC converters or VIPAC Arrays™ to meet conducted emission / conducted susceptibility per MIL-STD-461E; and input transients per MIL-STD-704A/E/F and MIL-STD-1275A/B/D. The MVA-FIAM9 accepts an input voltage of 10 – 36V<sub>DC</sub> and delivers output power up to 500W.

MVA-FIAM9 is mounted on a 4.69 x 3.62in coldplate with a height of 0.81in and convenient input and output connectors.

<sup>[a]</sup> EMI performance is subject to a wide variety of external influences such as PCB construction, circuit layout etc. As such, external components in addition to those listed herein may be required in specific instances to gain full compliance to the standards specified.

#### Part Numbering

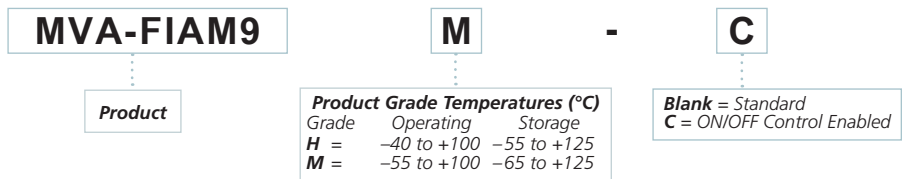

Note: Product images may not highlight current product markings.

## Specifications

(Typical at  $T_{BP} = 25^{\circ}\text{C}$ , nominal line and 75% load, unless otherwise specified.)

### Input Specifications

Parameter	Min	Typ	Max	Unit	Notes
Input voltage	10	28	36	$V_{DC}$	Continuous
Inrush limiting			0.007	A/ $\mu\text{F}$	
Transient immunity			100	$V_{DC}$	50ms per MIL-STD-1275A/B/D, continuous operation
			250	$V_{DC}$	70 $\mu\text{s}$ per MIL-STD-1275A/B/D, continuous operation
			70	$V_{DC}$	20ms per MIL-STD-704A, continuous operation
			50	$V_{DC}$	12.5ms per MIL-STD-704E/F, continuous operation

### Output Specifications

Parameter	Min	Typ	Max	Unit	Notes
Output power			500	W	
Output current			18	A	
Efficiency	96	97		%	
Internal voltage drop		0.85	1.5	V	500W, $25^{\circ}\text{C}$ baseplate
External capacitance	330		1000	$\mu\text{F}$	See Figure 5 on page 4 50V

### Control Pin Specifications

Parameter	Min	Typ	Max	Unit	Notes
ON/OFF control					
Enable (ON)	0.0		1.0	$V_{DC}$	Referenced to $-V_{OUT}$
Disable (OFF)	3.5		5.0	$V_{DC}$	100k $\Omega$ internal pull up resistor

### Safety Specifications

Parameter	Min	Typ	Max	Unit	Notes
Dielectric withstand	1,500			$V_{RMS}$	Input/Output to Base
	2,121			$V_{DC}$	Input/Output to Base

### EMI

Standard	Test Procedure	Notes
MIL-STD-461E		
Conducted emissions:	CE101, CE102	When using with V28 series converters a 27 $\mu\text{H}$ inductor is needed between the filter and converter for compliance below 30% of rated power.
Conducted susceptibility:	CS101, CS114, CS115, CS116	

EMI performance is subject to a wide variety of external influences such as PCB construction, circuit layout etc. As such, external components in addition to those listed herein may be required in specific instances to gain full compliance to the standards specified.

### General Specifications

Parameter	Min	Typ	Max	Unit	Notes
Weight			0.7 [318]	Lbs [grams]	
Warranty			2	Years	

## Specifications (Cont.)

### Module Environmental Qualification

<b>Altitude</b>
MIL-STD-810F, Method 500.4, Procedure I & II, 40,000ft. and 70,000ft. Operational.
<b>Explosive Atmosphere</b>
MIL-STD-810F, Method 511.4, Procedure I, Operational.
<b>Vibration</b>
MIL-STD-810F, Method 514.5, Procedure I, Category 14, Sine and Random vibration per Table 514.5C for Helicopter AH-6J Main Rotor with overall level of 5.6Grms for 4 hours per axis. MIL-STD-810F, Method 514.5C, General Minimum Integrity Curve per Figure 514.5C-17 with overall level of 7.7Grms for 1 hour per axis.
<b>Shock</b>
MIL-STD-810F, Method 516.5, Procedure I, Functional Shock, 40g. MIL-S-901D, Lightweight Hammer Shock, 3 impacts / axis, 1,3,5ft. MIL-STD-202F, Method 213B, 60g, 9ms half sine. MIL-STD-202F, Method 213B, 75g, 11ms Saw Tooth Shock.
<b>Acceleration</b>
MIL-STD-810F, Method 513.5, Procedure II, table 513.5-II, Operational, 2-7g, 6 directions.
<b>Humidity</b>
MIL-STD-810F, Method 507.4.
<b>Solder Test</b>
MIL-STD-202G, Method 208H, 8 hour aging.

### Module Environmental Stress Screening

Parameter	H-Grade	M-Grade
Operating temperature	-40 to +100°C	-55 to +100°C
Storage temperature	-55 to +125°C	-65 to +125°C
Temperature cycling*	12 cycles -65 to +100°C	12 cycles -65 to +100°C
Ambient test at 25°C	Yes	Yes
Power cycling burn-in	12 hours, 29 cycles	24 hours, 58 cycles
Functional and parametric ATE tests	-40 and +100°C	-55 and +100°C
Hi-Pot test	Yes	Yes
Visual inspection	Yes	Yes
Test data	<a href="http://vicorpower.com">vicorpower.com</a>	<a href="http://vicorpower.com">vicorpower.com</a>

\*Temperature cycled with power off, 17°C per minute rate of change.

## Storage

Vicor products, when not installed in customer units, should be stored in ESD safe packaging in accordance with ANSI/ESD S20.20, "Protection of Electrical and Electronic Parts, Assemblies and Equipment" and should be maintained in a temperature controlled factory/ warehouse environment not exposed to outside elements controlled between the temperature ranges of 15°C and 38°C. Humidity shall not be condensing, no minimum humidity when stored in an ESD compliant package.

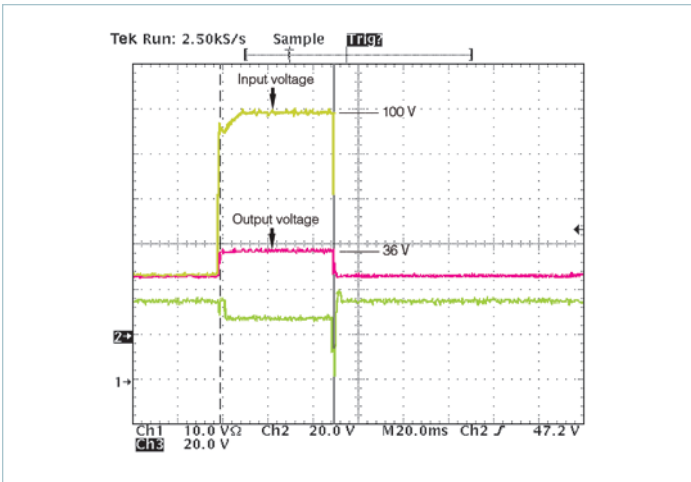

Figure 1 — Transient immunity: MVA-FIAM9 output response to an input transient

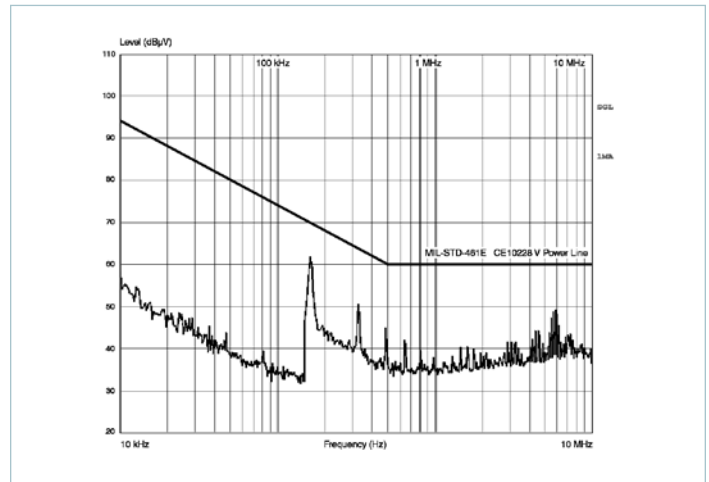

Figure 2 — Conducted noise; MVA-FIAM9 and model V28A12M200B DC-DC converter operating at 28V<sub>DC</sub>, 200W

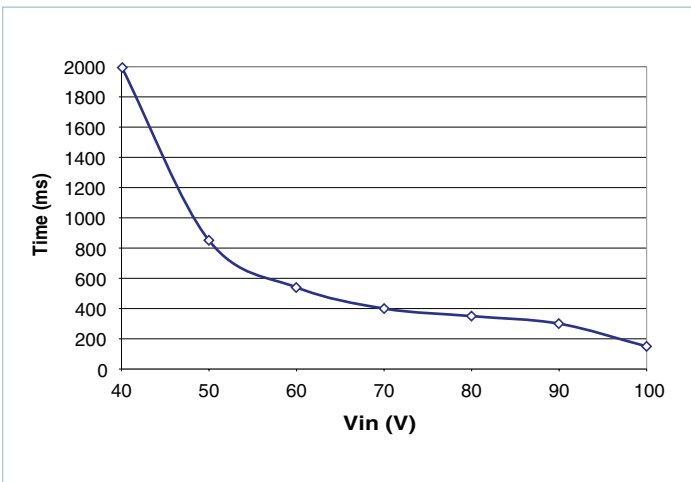

Figure 3 — Shut down time of MVA-FIAM9 vs. overvoltage

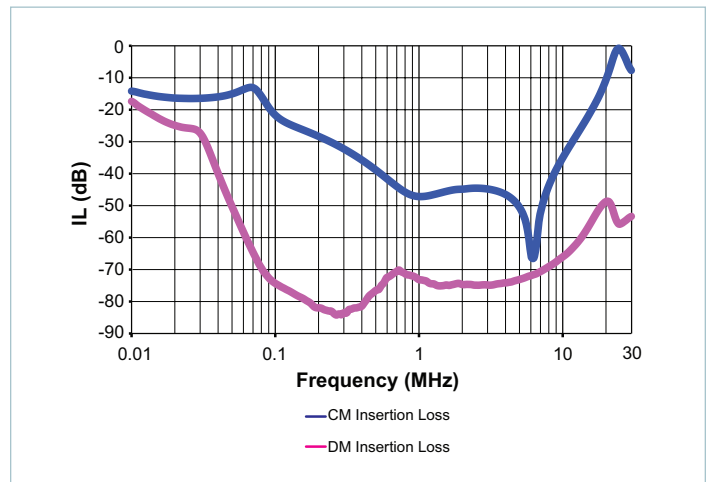

Figure 4 — MVA-FIAM9 insertion loss

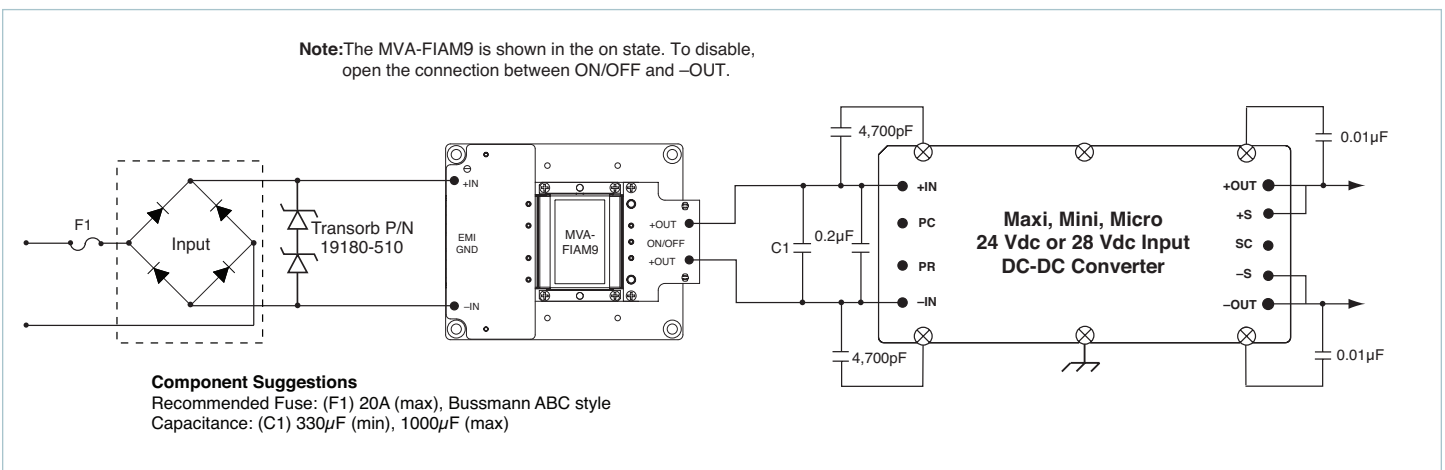
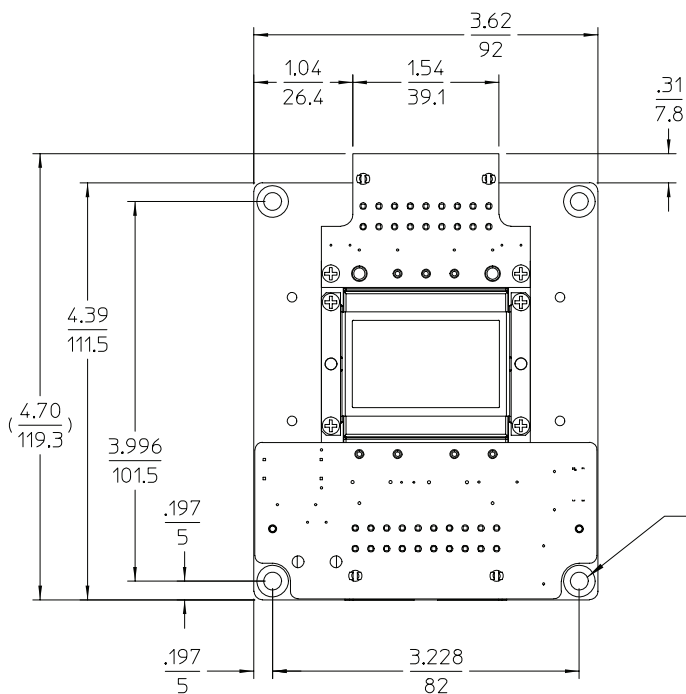
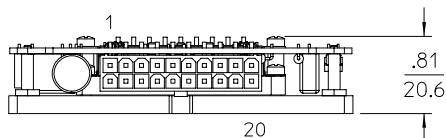

Figure 5 — Transient, surge protection and recommended reverse polarity protection.

INCHES  
MM



TOLERANCES:  $\frac{.XX}{MM} = \frac{.02}{.5}$       $\frac{.XXX}{MM} = \frac{.010}{.25}$



1										10
11										20

1										9
10										18

**Input Connector**

Pin #	Function
1 – 4	-VIN
5 – 7	+VIN
8	NC
9	PE protective earth
10	PE protective earth
11 – 13	-VIN
14 – 17	+VIN
18	NC
19	PE protective earth
20	PE protective earth

**Output Connector**

Pin #	Function	Pin #	Function
1	+VOUT	10	+VOUT
2	+VOUT	11	+VOUT
3	+VOUT	12	+VOUT
4	N/C	13	NC
5	N/C	14	NC
6	N/C	15	On / Off
7	-VOUT	16	-VOUT
8	-VOUT	17	-VOUT
9	-VOUT	18	-VOUT

Input Mounting Connector	TE Connectivity P/N	Vicor P/N
Housing	2-794657-0	
Pin	1-106529-2	
Kit		24828

Input Mounting Connector	TE Connectivity P/N	Vicor P/N
Housing	TYC1-794657-8	
Pin	1-106529-2	
Kit		25067

**Note:** The MVA-FIAM9H and MVA-FIAM9M are delivered with the On / Off control already configured as On using a 0Ω resistor on the underside of the output connector board. The MVA-FIAM9H-C and MVA-FIAM9M-C are delivered without the 0Ω resistor installed, allowing for user control of the On / Off functionality.

Figure 6 — MVA-FIAM9 outline and pinouts

**Vicor's comprehensive line of power solutions includes high density AC-DC and DC-DC modules and accessory components, fully configurable AC-DC and DC-DC power supplies, and complete custom power systems.**

Information furnished by Vicor is believed to be accurate and reliable. However, no responsibility is assumed by Vicor for its use. Vicor makes no representations or warranties with respect to the accuracy or completeness of the contents of this publication. Vicor reserves the right to make changes to any products, specifications, and product descriptions at any time without notice. Information published by Vicor has been checked and is believed to be accurate at the time it was printed; however, Vicor assumes no responsibility for inaccuracies. Testing and other quality controls are used to the extent Vicor deems necessary to support Vicor's product warranty. Except where mandated by government requirements, testing of all parameters of each product is not necessarily performed.

**Specifications are subject to change without notice.**

Visit [http://www.vicorpower.com/mil-cots\\_dc-dc/mil-cots\\_m-fiam\\_filter\\_input\\_attenuator\\_module](http://www.vicorpower.com/mil-cots_dc-dc/mil-cots_m-fiam_filter_input_attenuator_module) for the latest product information.

**Vicor's Standard Terms and Conditions and Product Warranty**

All sales are subject to Vicor's Standard Terms and Conditions of Sale, and Product Warranty which are available on Vicor's webpage (<http://www.vicorpower.com/termsconditionswarranty>) or upon request.

**Life Support Policy**

VICOR'S PRODUCTS ARE NOT AUTHORIZED FOR USE AS CRITICAL COMPONENTS IN LIFE SUPPORT DEVICES OR SYSTEMS WITHOUT THE EXPRESS PRIOR WRITTEN APPROVAL OF THE CHIEF EXECUTIVE OFFICER AND GENERAL COUNSEL OF VICOR CORPORATION. As used herein, life support devices or systems are devices which (a) are intended for surgical implant into the body, or (b) support or sustain life and whose failure to perform when properly used in accordance with instructions for use provided in the labeling can be reasonably expected to result in a significant injury to the user. A critical component is any component in a life support device or system whose failure to perform can be reasonably expected to cause the failure of the life support device or system or to affect its safety or effectiveness. Per Vicor Terms and Conditions of Sale, the user of Vicor products and components in life support applications assumes all risks of such use and indemnifies Vicor against all liability and damages.

**Intellectual Property Notice**

Vicor and its subsidiaries own Intellectual Property (including issued U.S. and Foreign Patents and pending patent applications) relating to the products described in this data sheet. No license, whether express, implied, or arising by estoppel or otherwise, to any intellectual property rights is granted by this document. Interested parties should contact Vicor's Intellectual Property Department.

Contact Us: <http://www.vicorpower.com/contact-us>

**Vicor Corporation**  
25 Frontage Road  
Andover, MA, USA 01810  
Tel: 800-735-6200  
Fax: 978-475-6715  
[www.vicorpower.com](http://www.vicorpower.com)

**email**

Customer Service: [custserv@vicorpower.com](mailto:custserv@vicorpower.com)  
Technical Support: [apps@vicorpower.com](mailto:apps@vicorpower.com)

# Mouser Electronics

Authorized Distributor

Click to View Pricing, Inventory, Delivery & Lifecycle Information:

## Vicor:

[M-FIAM9H22](#) [M-FIAM9M22](#) [M-FIAM9HG1](#) [M-FIAM9HN1](#) [M-FIAM9HG2](#) [M-FIAM9H21](#) [M-FIAM9M21](#) [M-FIAM9MG3](#) [M-FIAM9MG1](#) [M-FIAM9MG2](#) [M-FIAM9MK1](#) [M-FIAM9MK2](#) [M-FIAM9MN1](#) [M-FIAM9MN2](#) [M-FIAM9MN3](#) [M-FIAM9MS1](#) [M-FIAM9MS3](#) [M-FIAM9H11](#) [M-FIAM9H12](#) [M-FIAM9H13](#) [M-FIAM9H23](#) [M-FIAM9HF1](#) [M-FIAM9HF2](#) [M-FIAM9HG3](#) [M-FIAM9HK1](#) [M-FIAM9HK3](#) [M-FIAM9HN2](#) [M-FIAM9HN3](#) [M-FIAM9HS1](#) [M-FIAM9M11](#) [M-FIAM9M12](#) [M-FIAM9M21-01](#) [M-FIAM9M23](#) [MVA-FIAM9H](#) [MVA-FIAM9M-C](#) [MVA-FIAM9H-C](#) [M-FIAM9M2I](#)