

Product Description

Qorvo's TGA2597-SM is a packaged driver amplifier fabricated on Qorvo's QGaN25 0.25um GaN on SiC production process. The TGA2597-SM operates from 2.0 to 6.0GHz and provides 32 dBm of output power with 14 dB of large signal gain and 31 % power-added efficiency.

Using GaN MMIC technology and plastic packaging, the TGA2597-SM provides a low cost driver solution that provides the added benefit of operating on the same voltage rail as the corresponding GaN HPA. It can also serve as the output power amplifier in lower power architectures.

The TGA2597-SM is offered in a 4x4 mm plastic overmold QFN. It is internally matched to 50 ohms and includes integrated DC blocking caps on both RF ports allowing for simple system integration.

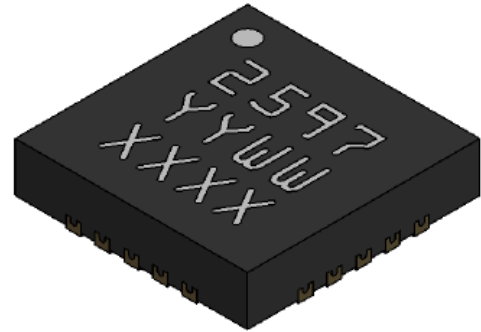

Product Features

- Frequency Range: 2 – 6 GHz
- Small Signal Gain: > 24 dB
- Power: > 32 dBm
- PAE: > 31 %
- IM3: < -24 dBc
- Bias: $V_D = 25\text{ V}$, $I_{DQ} = 40\text{ mA}$
- Package Dimensions: 4.0 x 4.0 x 0.85 mm

Performance is typical across frequency. Please reference electrical specification table and data plots for more details

Applications

- Commercial & Military Radar
- Communications
- Electronic Warfare (EW)

Functional Block Diagram

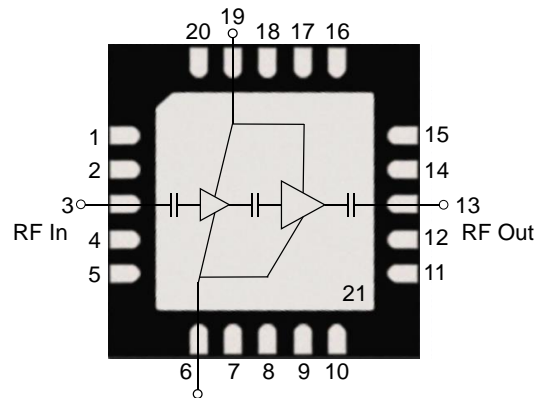

Ordering Information

Part No.	Description
TGA2597-SM	Driver Amplifier, Waffle Pack, Qty 50
TGA2597-SMTR7	Tape and Reel, 7", Qty 500
TGA2597-SMEVB	TGA2597-SM Evaluation Board, Qty 1

Recommended Operating Conditions

Parameter	Min	Typ	Max	Units
Drain Voltage (V_D)		25		V
Drain Current (I_{DQ})		40		mA
Drain Current Under RF Drive (I_{D_DRIVE})		See Performance Plots		mA
Gate Voltage (V_G)		-2.5		V
Gate Current Under RF Drive (I_{G_DRIVE})		See Performance Plots		mA
Temperature (T_{BASE})	-40		+85	°C

Electrical performance is measured under conditions noted in the electrical specifications table. Specifications are not guaranteed over all recommended operating conditions.

Electrical Specifications

Parameter	Conditions	Min	Typ	Max	Units
Operational Frequency Range		2		6	GHz
Output Power	$P_{IN} = 18$ dBm		> 32		dBm
Power Added Efficiency	$P_{IN} = 18$ dBm		> 31		%
Small Signal Gain			> 24		dB
Input Return Loss			20		dB
Output Return Loss			> 5		dB
IM3	$P_{OUT}/Tone \leq 24$ dBm, $\Delta f = 10$ MHz		< -24		dBc
Gate Leakage	$V_D = +10$ V, $V_G = -3.7$ V	-0.924	-0.05		mA
Gain Temperature Coefficient			-0.050		dB/°C
Output Power Temperature Coefficient			-0.009		dB/°C

Test conditions unless otherwise noted: $T_{BASE} = +25$ °C, $V_D = 25$ V, $V_G = -2.5$ V, CW

Absolute Maximum Ratings

Parameter	Range / Value	Units
Drain Voltage (V_D)	+40	V
Gate Voltage (V_G)	-5 to 0	V
Drain Current (I_D)	400	mA
Gate Current (I_G)	10	mA
Power Dissipation, 85 °C (P_{DISS})	5.4	W
RF Input Power, CW, 50 Ω ¹	24	dBm
RF Input Power, CW, VSWR 3:1 ¹	24	dBm
Channel Temperature (T_{CH})	+275	°C
Mounting Temperature (30 seconds maximum)	+260	°C
Storage Temperature	-55 to +150	°C

Operation of this device outside the parameter ranges given above may cause permanent damage. These are stress ratings only, and functional operation of the device at these conditions is not implied. Extended application of Absolute Maximum Rating conditions may reduce device reliability.

(1) $V_D = 25V$, $I_{DQ} = 40mA$, $T_B = 85\text{ °C}$

Thermal and Reliability Information

Parameter	Values	Units	Conditions
Thermal Resistance (θ_{JC}) ^(1,2,3)	16.52	°C/W	$T_{BASE} = +85\text{ °C}$, $V_D = 25\text{ V}$, $I_{DQ} = 40\text{ mA}$, $I_{D_DRIVE} = 206\text{ mA}$, $P_{IN} = 18\text{ dBm}$, $P_{OUT} = 31.8\text{ dBm}$, $P_{DISS} = 3.7\text{ W}$
Channel Temperature (T_{CH})	146.14	°C	

Notes:

1. Thermal resistance is measured to package backside
2. Base or ambient temperature is 85 °C
3. Refer to the following document: [GaN Device Channel Temperature, Thermal Resistance, and Reliability Estimates](#)

Performance Plots – Small Signal

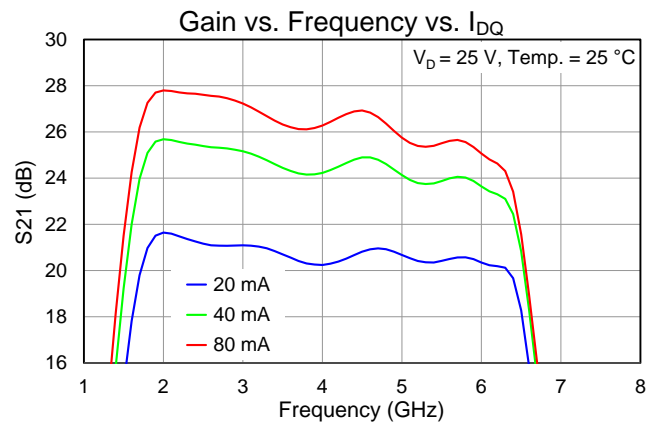
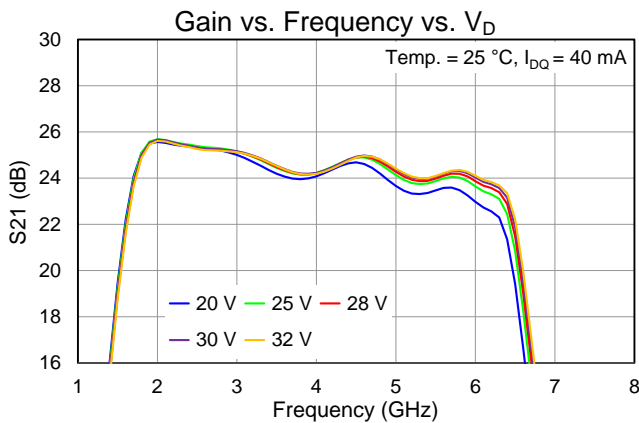
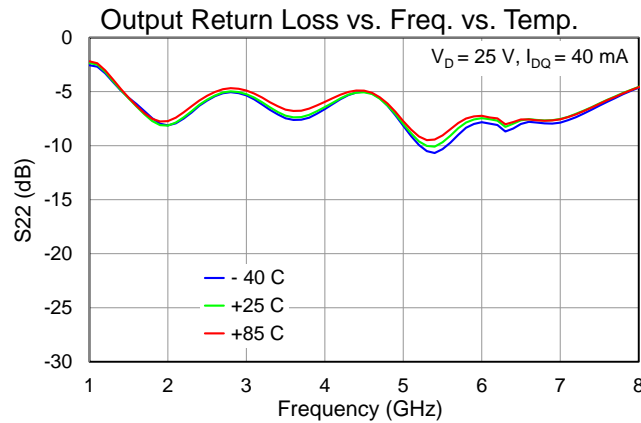
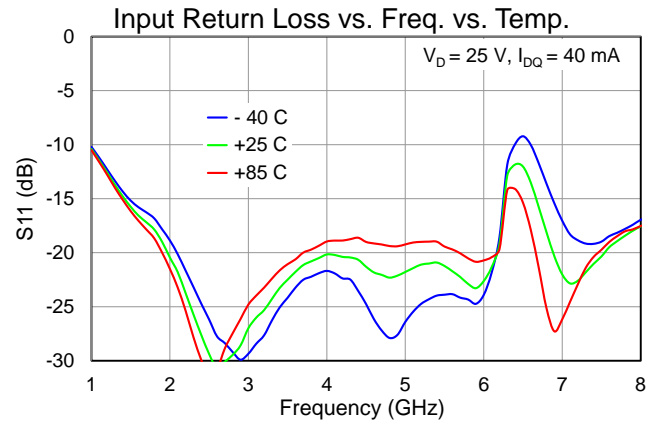
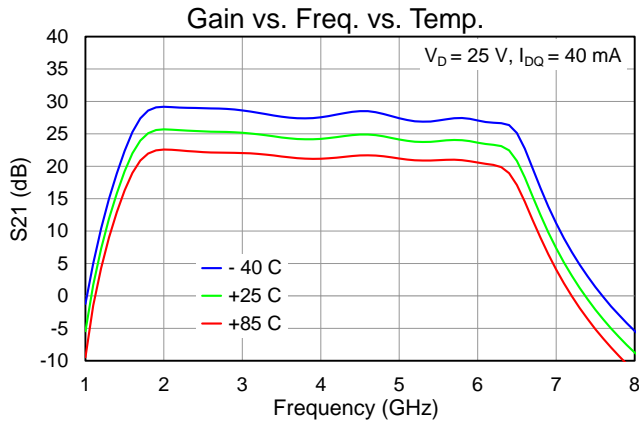

Performance Plots – Large Signal

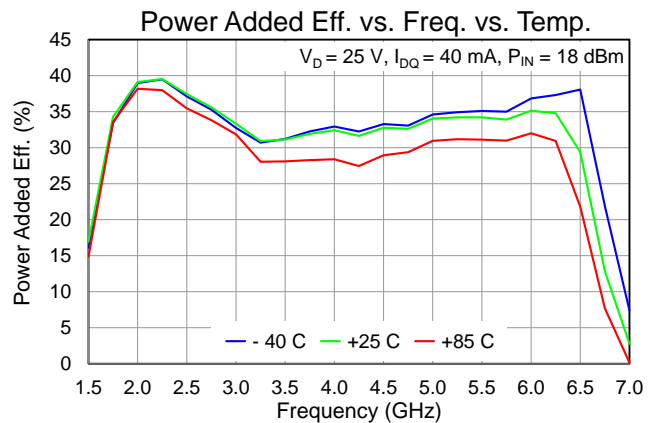
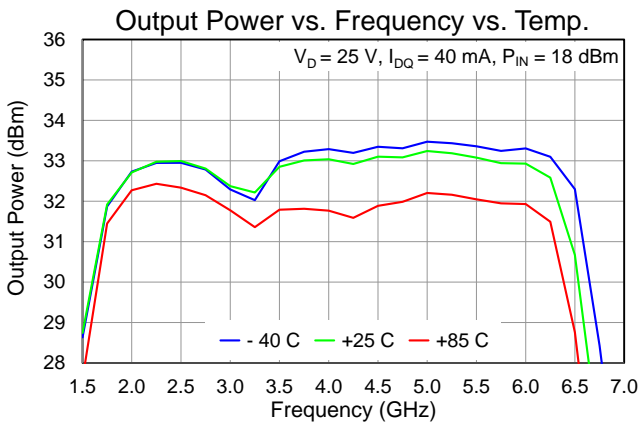
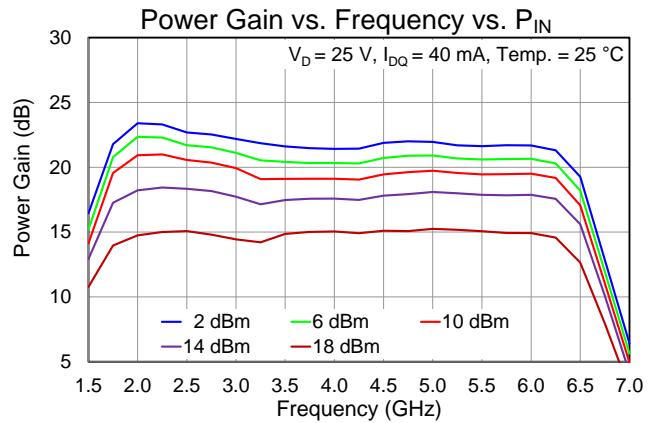
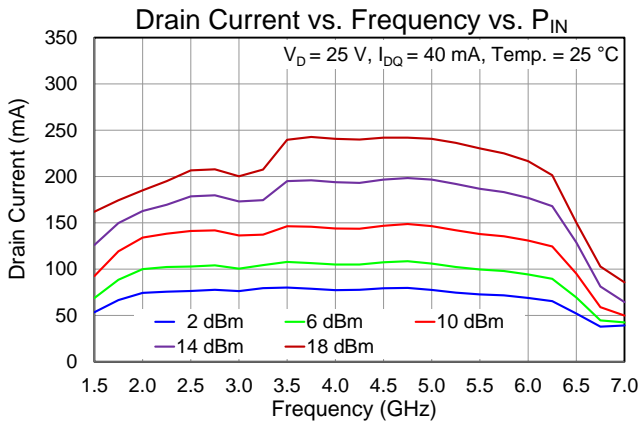
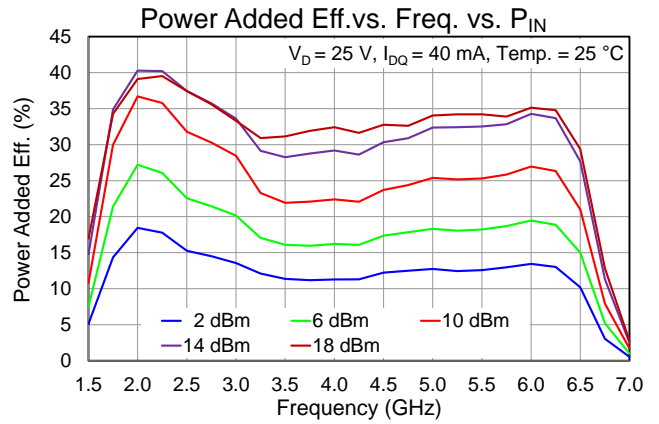
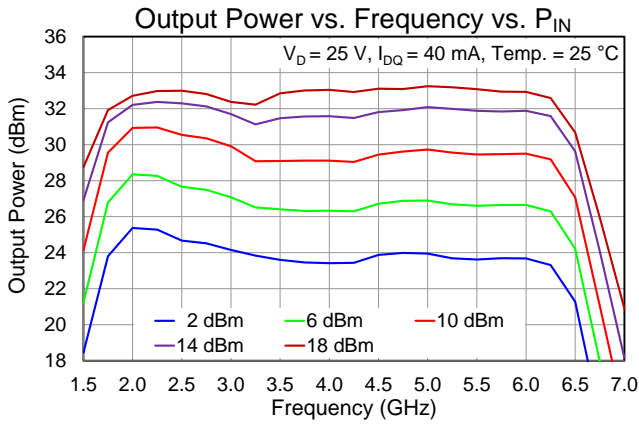

Performance Plots – Large Signal

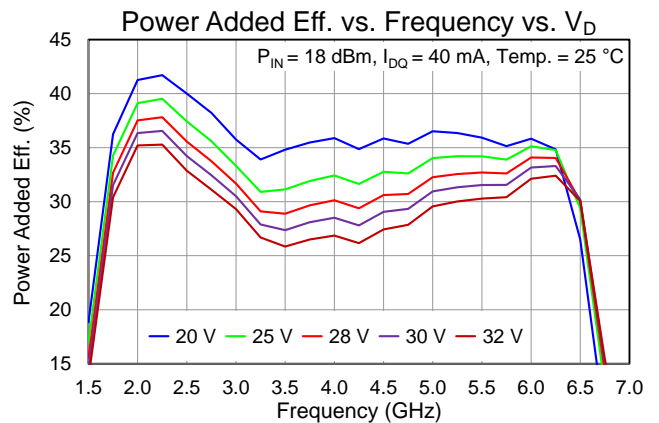
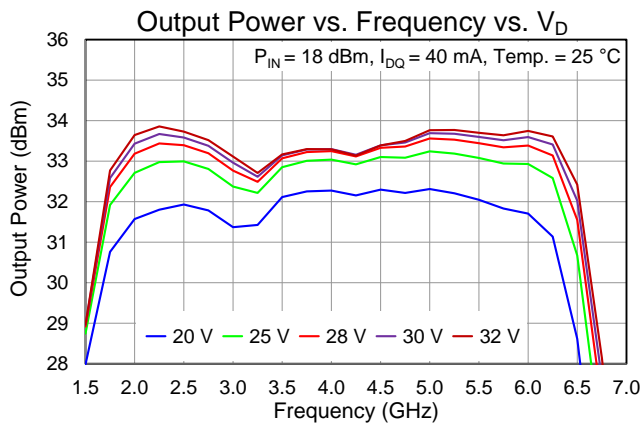
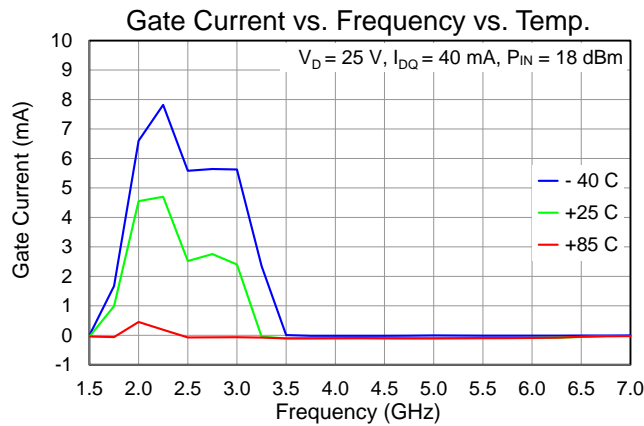
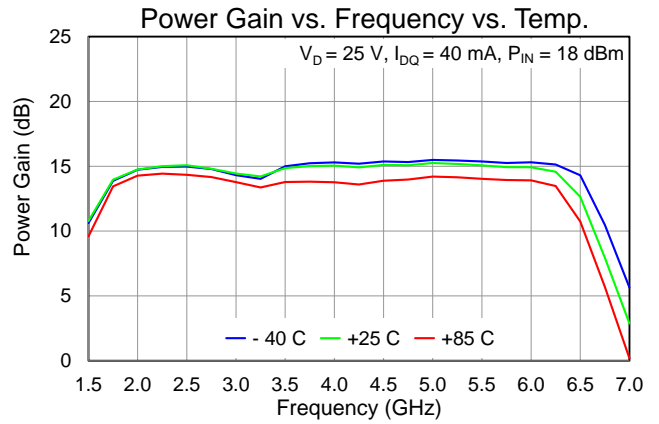
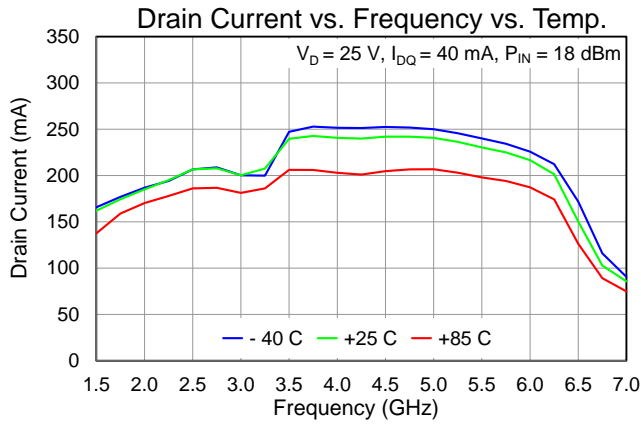

Performance Plots – Large Signal

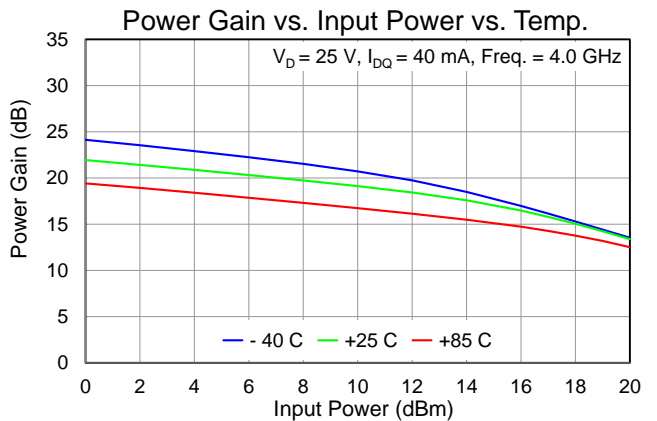
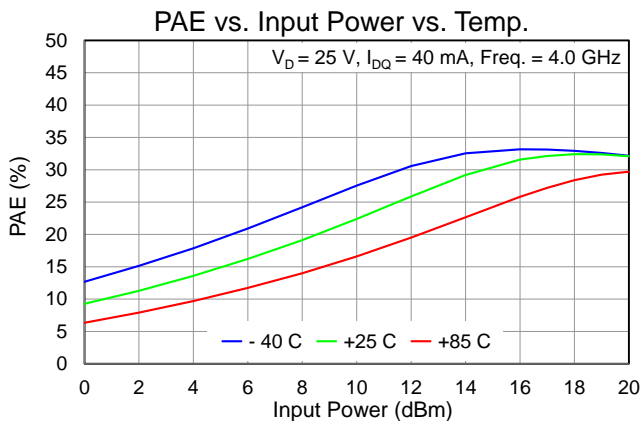
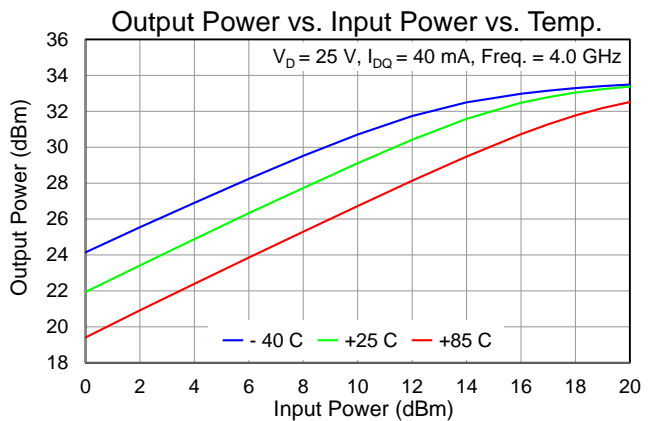
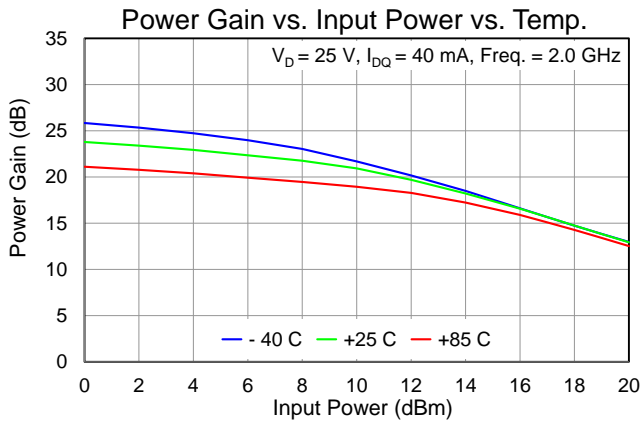
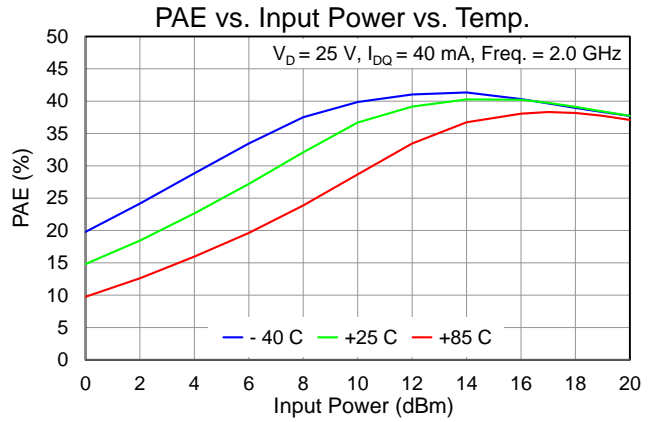
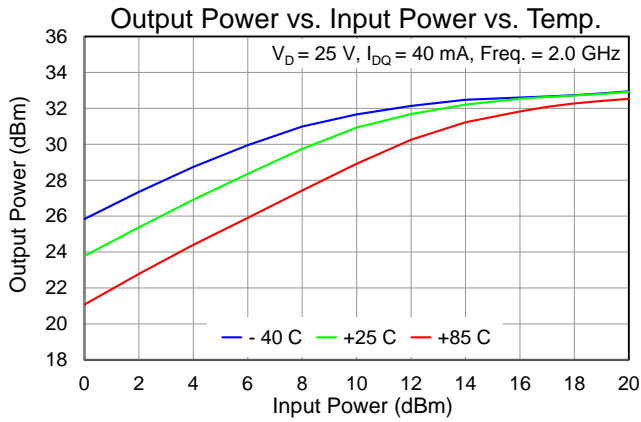

Performance Plots – Large Signal

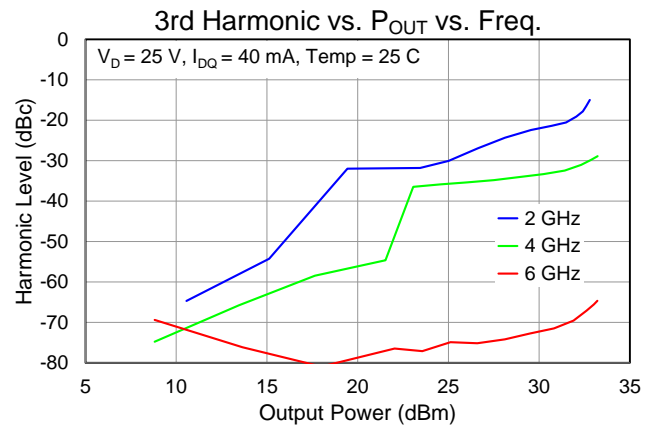
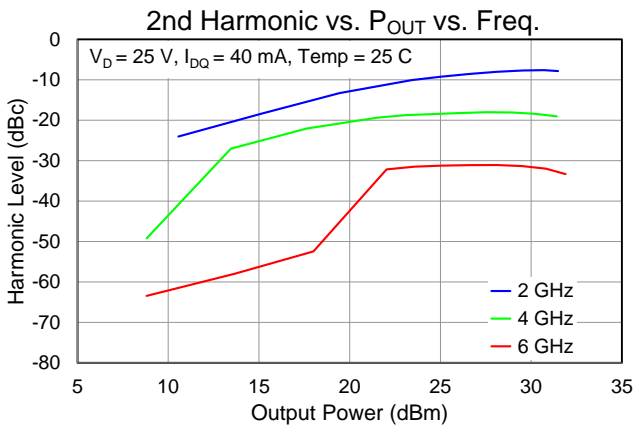
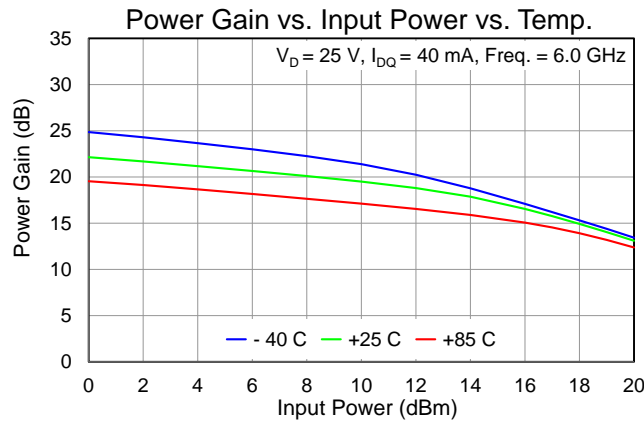
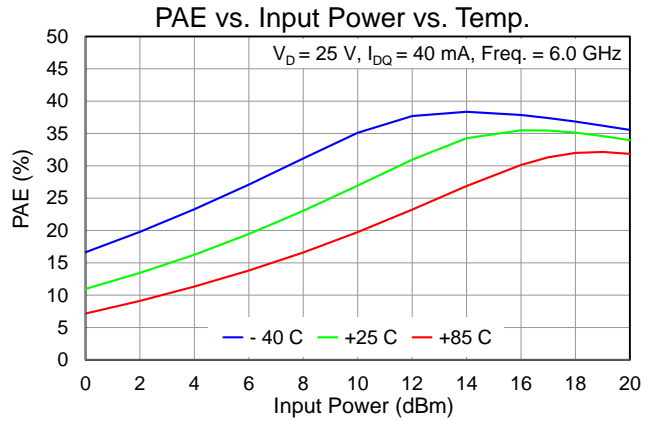
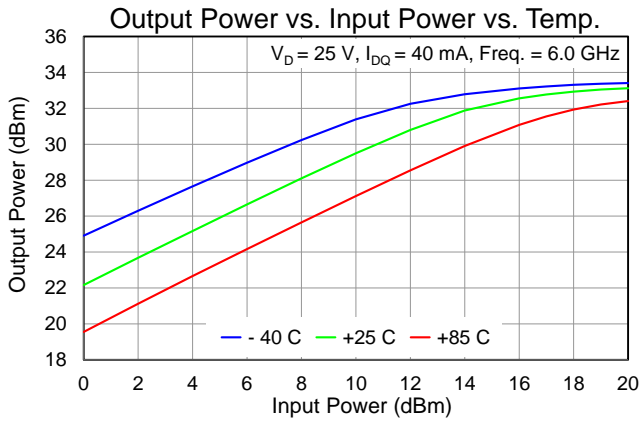

Performance Plots – Linearity & Harmonic

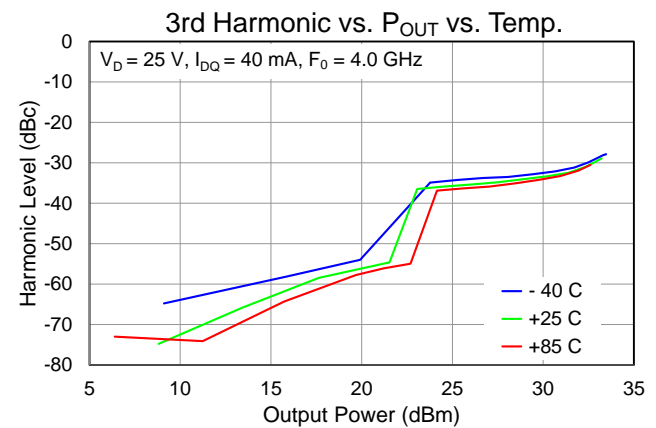
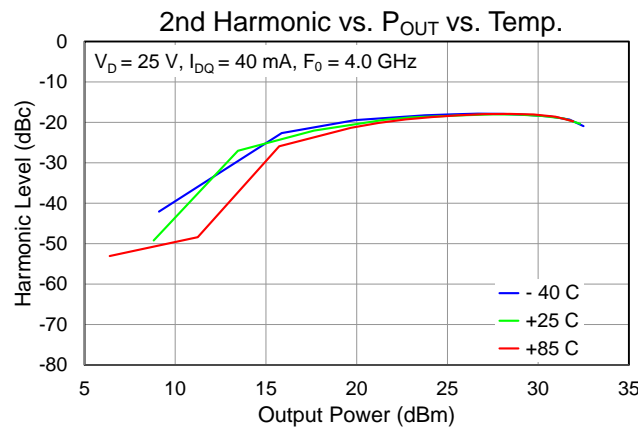
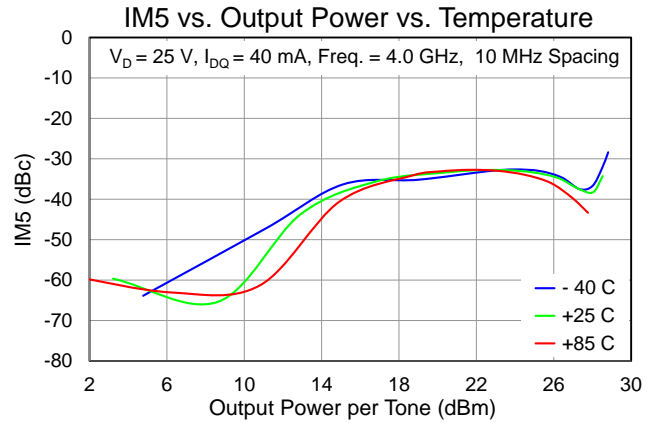
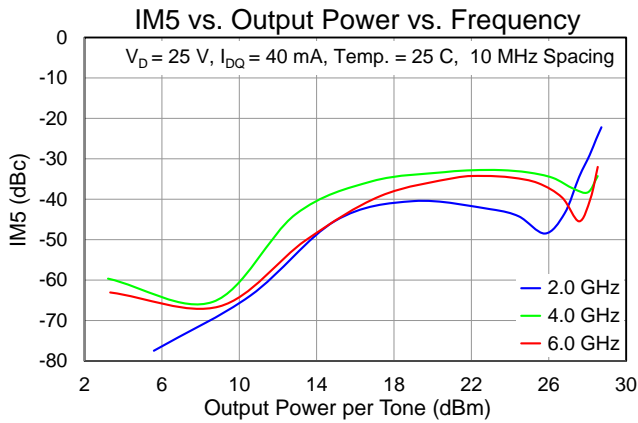
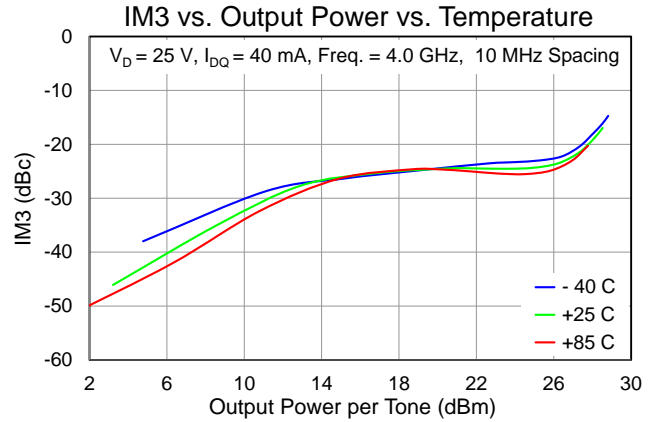
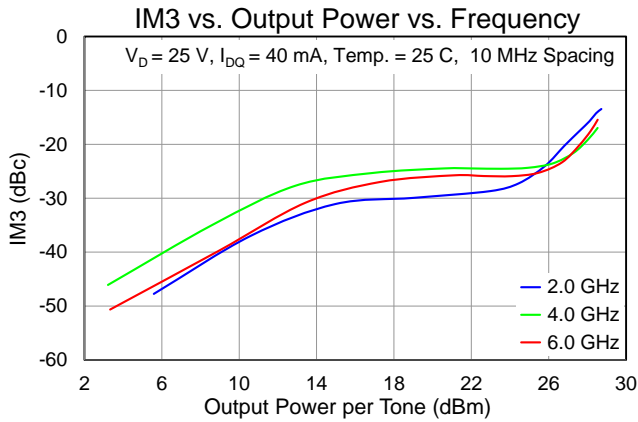

Application Circuit

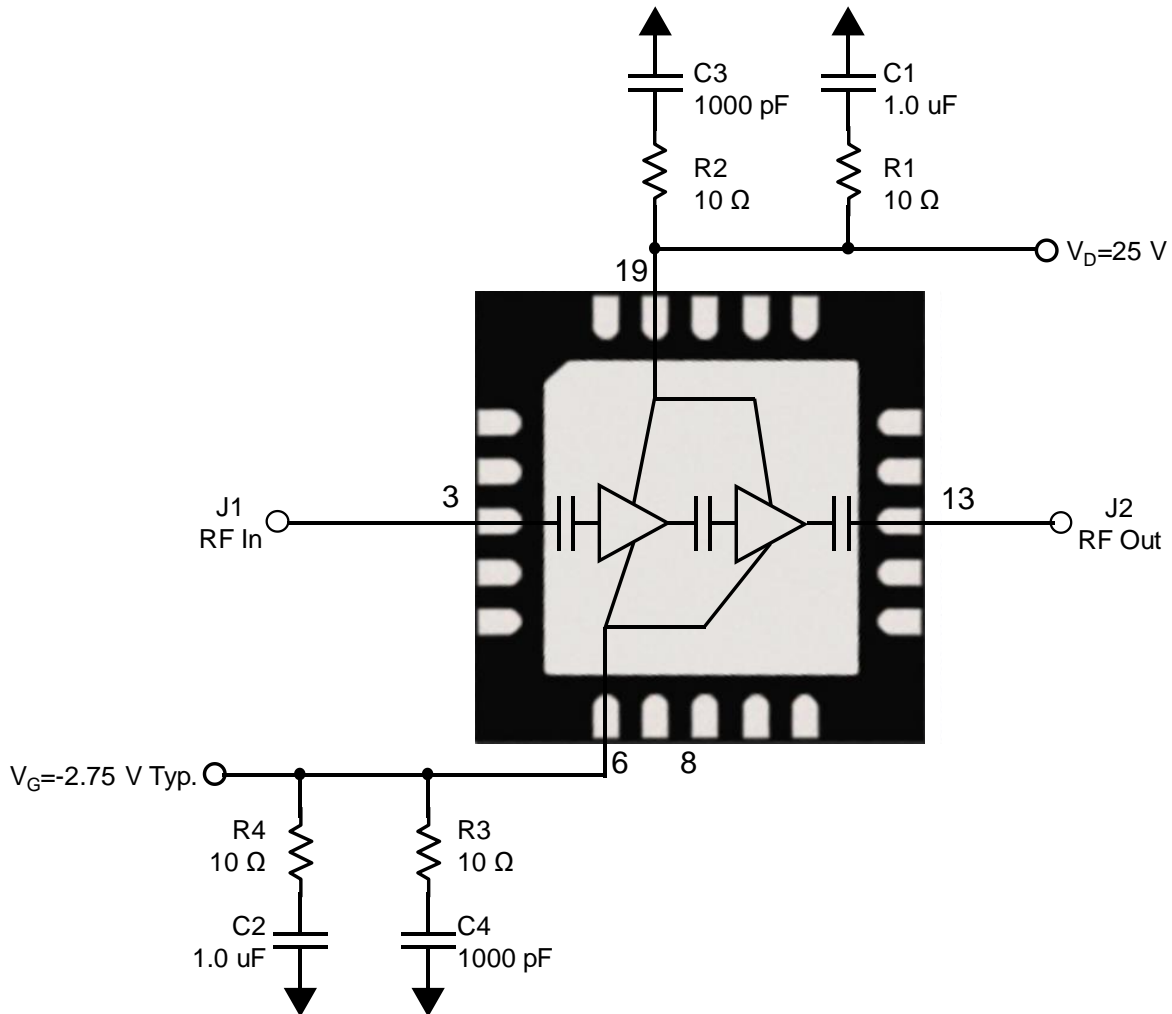

Bias Up Procedure

1. Set I_D limit to 400 mA, I_G limit to 4.5 mA
2. Set V_G to -5.0V
3. Set V_D +25V
4. Adjust V_G more positive until $I_{DQ} = 40$ mA.
5. Apply RF signal

Bias Down Procedure

1. Turn off RF signal
2. Set V_G to -5.0V. Ensure $I_{DQ} \sim 0$ mA
3. Set V_D to 0V
4. Turn off V_D supply
5. Turn off V_G supply

Evaluation Board Layout

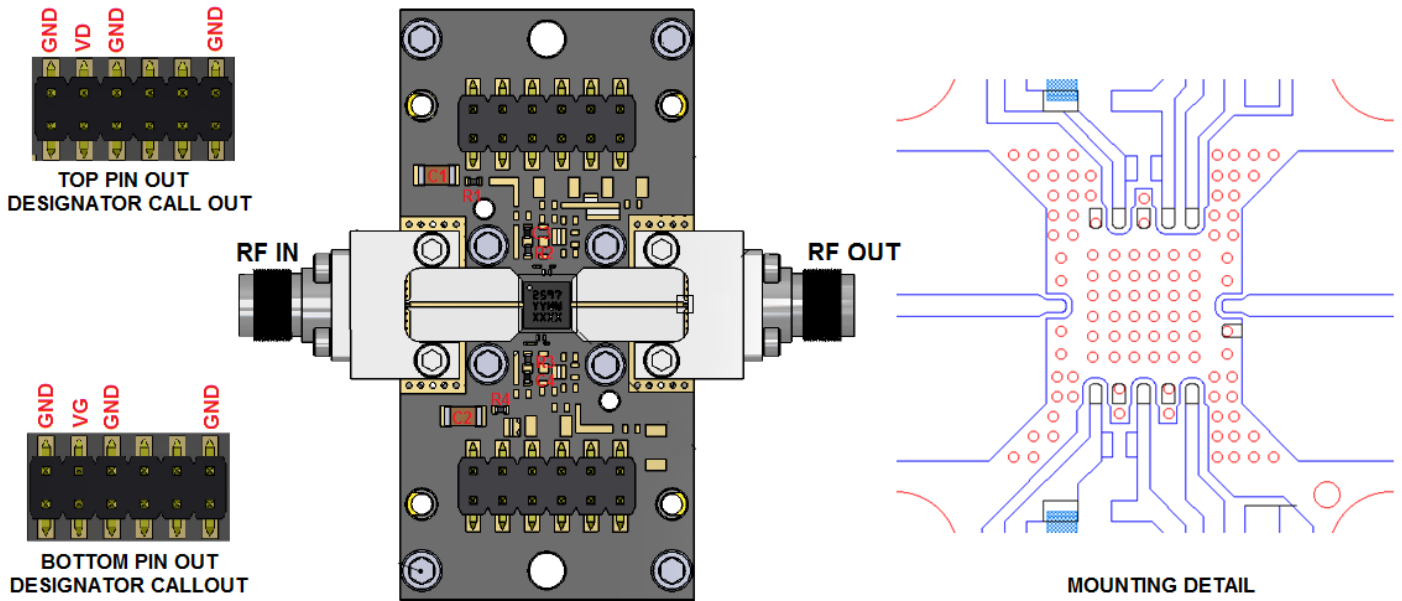

RF Layer is 0.008" thick Rogers Corp. RO4003C, $\epsilon_r = 3.38$. Metal layers are 0.5 oz. copper. The microstrip line at the connector interface is optimized for the Southwest Microwave end launch connector 1092-01A-5.

The pad pattern shown has been developed and tested for optimized assembly at Qorvo. The PCB land pattern has been developed to accommodate lead tolerances. Since processes vary from company to company, careful process development is recommended.

Multiple vias should be employed under the package center paddle to minimize inductance resistance.

Bill of Materials

Reference Des.	Value	Description	Manuf.	Part Number
C1, C2	1 uF, 50 V, 20 %	CAP X5R 1206	Various	–
C3, C4	1000 pF, 100 V, 10 %	CAP X7R 0402	Various	–
R1 – R4	10 Ohm, 1 %, 1/16 W	RES 0402 case	Various	–

Mechanical Information, Pin Configuration and Description

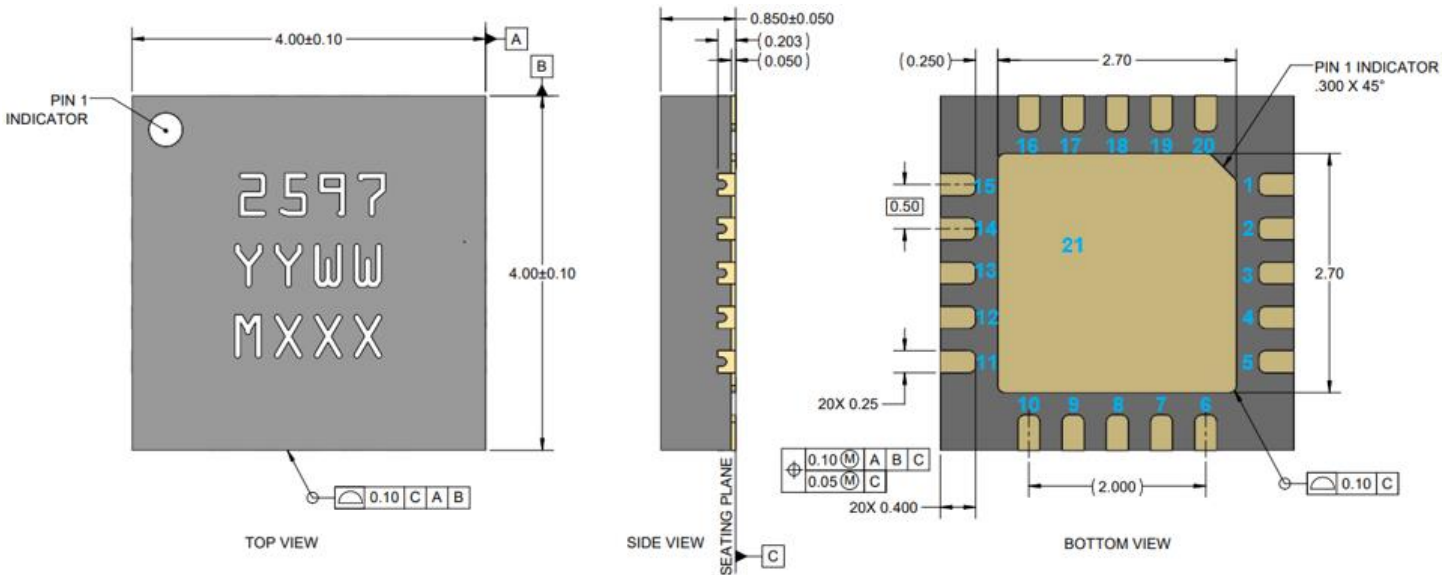

Dimensions in mm, package is mold encapsulated with gold plated leads

Part Marking: 2597: Part Number, YY = Part Assembly Year, WW = Part Assembly Week, MXXX = Batch ID

Pin No.	Label	Description
1-2, 4-5, 7-12, 14-18, 20	GND	Connected to ground paddle (21); recommend grounding on PCB for improved package isolation.
3	RF Input	RF input, matched to 50Ω , DC blocked
6	V_G	Gate voltage. Bias network required
13	RF Output	RF output, matched to 50Ω , DC blocked
19	V_D	Drain voltage. Bias network required.
21	Slug (GND)	Backside paddle. Multiple vias should be employed to minimize inductance and thermal resistance. Copper-filled vias recommended for best thermal performance.

Tape and Reel Information

Standard T/R size = 500 pieces on a 7" reel.

Material		Cavity (mm)				Distance Between Centerline (mm)		Carrier Tape (mm)	Cover Carrier (mm)
Vendor	Vendor P/N	Length (A0)	Width (B0)	Depth (K0)	Pitch (P1)	Length direction (P2)	Width Direction (F)	Width (W)	Width (W)
C-Pack	QFN0400 X 0400D	4.35	4.35	1.1	8.0	2.00	5.50	12.0	9.20

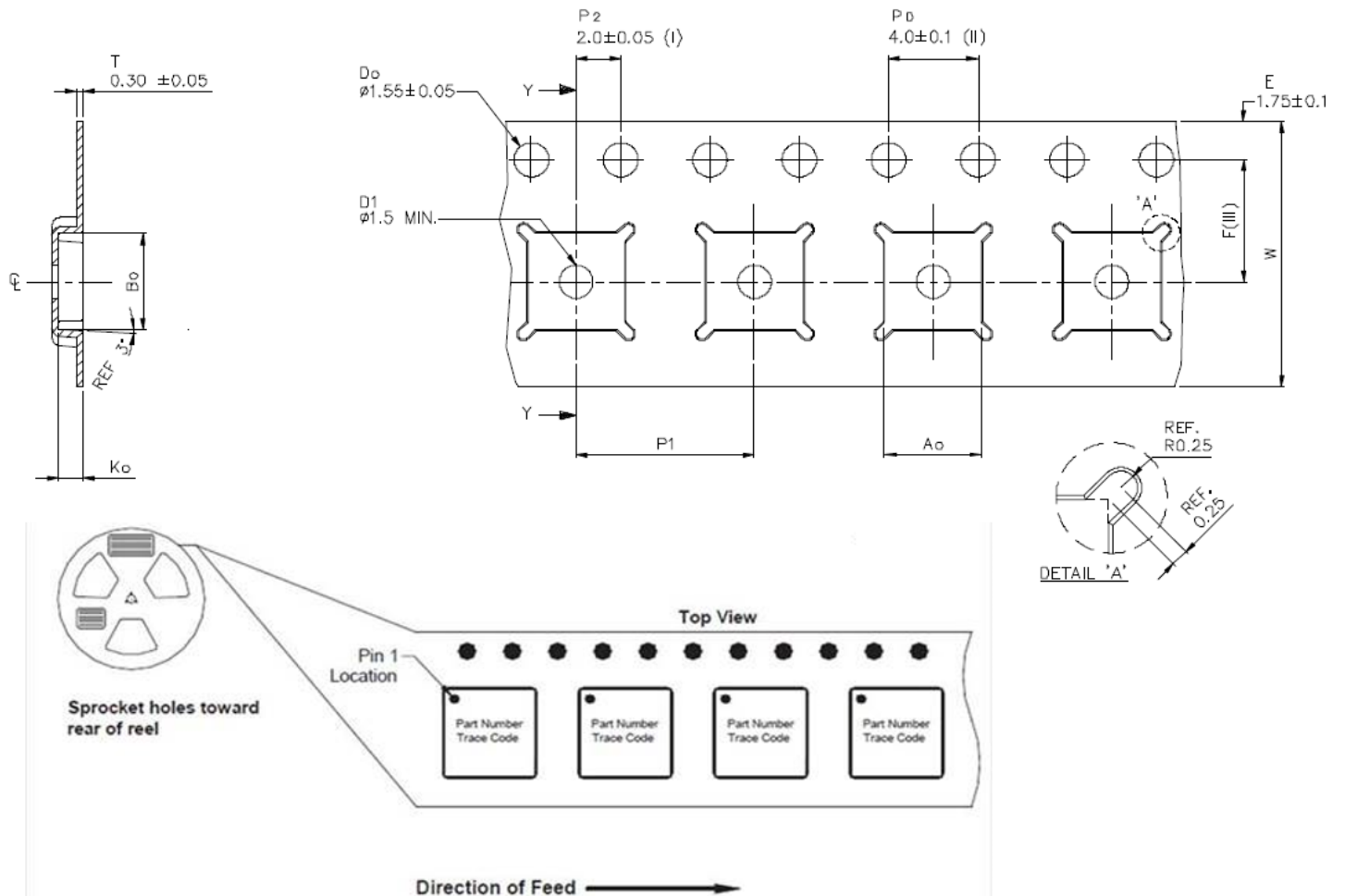

Solderability

- Compatible with the latest version of J-STD-020, Lead-free solder, 260 °C peak reflow temperature.

Recommended Soldering Temperature Profile

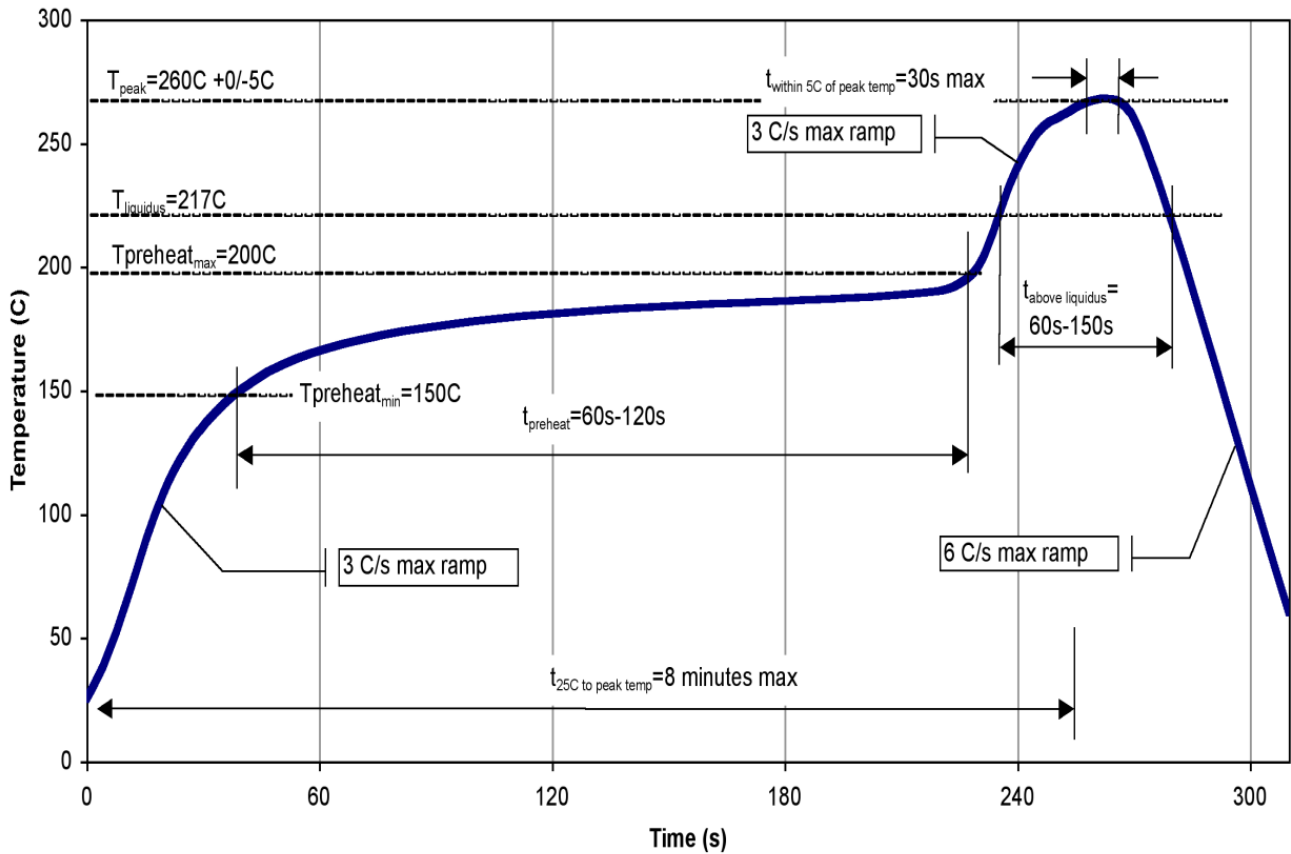

Handling Precautions

Parameter	Rating	Standard
ESD – Human Body Model (HBM)	Class 1A	ESDA / JEDEC JS-001-2012
ESD – Charge Device Model (CDM)	Class C2	JESD22-C101
MSL – 260 °C Convection Reflow	Level 3	JEDEC standard IPC/JEDEC-J-STD-020



Caution!
ESD-Sensitive Device

RoHS Compliance

This product is compliant with the 2011/65/EU RoHS directive (Restrictions on the Use of Certain Hazardous Substances in Electrical and Electronic Equipment), as amended by Directive 2015/863/EU. This product also has the following attributes:

- Lead Free
- Halogen Free (Chlorine, Bromine)
- Antimony Free
- TBBP-A (C₁₅H₁₂Br₄O₂) Free
- SVHC Free
- PFOS Free
-

Contact Information

For the latest specifications, additional product information, worldwide sales and distribution locations:

Tel: 1-844-890-8163

Web: www.qorvo.com

Email: customer.support@qorvo.com

Important Notice

The information contained herein is believed to be reliable; however, Qorvo makes no warranties regarding the information contained herein and assumes no responsibility or liability whatsoever for the use of the information contained herein. All information contained herein is subject to change without notice. Customers should obtain and verify the latest relevant information before placing orders for Qorvo products. The information contained herein or any use of such information does not grant, explicitly or implicitly, to any party any patent rights, licenses, or any other intellectual property rights, whether with regard to such information itself or anything described by such information. **THIS INFORMATION DOES NOT CONSTITUTE A WARRANTY WITH RESPECT TO THE PRODUCTS DESCRIBED HEREIN, AND QORVO HEREBY DISCLAIMS ANY AND ALL WARRANTIES WITH RESPECT TO SUCH PRODUCTS WHETHER EXPRESS OR IMPLIED BY LAW, COURSE OF DEALING, COURSE OF PERFORMANCE, USAGE OF TRADE OR OTHERWISE, INCLUDING THE IMPLIED WARRANTIES OF MERCHANTABILITY AND FITNESS FOR A PARTICULAR PURPOSE.**

Without limiting the generality of the foregoing, Qorvo products are not warranted or authorized for use as critical components in medical, life-saving, or life-sustaining applications, or other applications where a failure would reasonably be expected to cause severe personal injury or death.

© 2021 Qorvo US, Inc. All rights reserved. This document is subject to copyright laws in various jurisdictions worldwide and may not be reproduced or distributed, in whole or in part, without the express written consent of Qorvo US, Inc. | QORVO® is a registered trademark of Qorvo US, Inc.

Mouser Electronics

Authorized Distributor

Click to View Pricing, Inventory, Delivery & Lifecycle Information:

[Qorvo:](#)

[TGA2597-SM](#) [TGA2597-SM EVB](#) [TGA2597-SMTR7](#)