



CMD249P5

DC-20 GHz Distributed Power Amplifier

Features

- ▶ Ultra wideband performance
- ▶ High linearity
- ▶ High output power
- ▶ Excellent return losses
- ▶ Pb-free RoHs compliant 5x5 QFN package

Description

The CMD249P5 is wideband GaAs MMIC distributed power amplifier housed in a leadless 5x5 mm plastic surface mount package. The amplifier delivers 12.5 dB of gain with a corresponding output 1 dB compression point of +28 dBm and an output IP3 of 39 dBm at 10 GHz. The CMD249P5 is a 50 ohm matched design which eliminates the need for RF port matching.

Functional Block Diagram

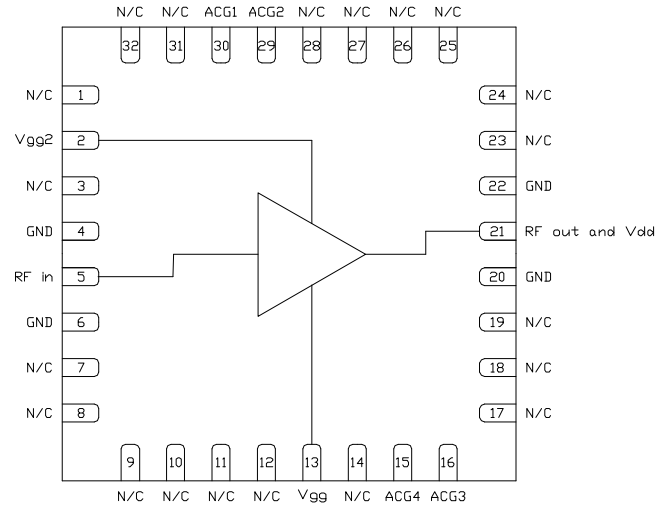

Note: Vgg2 is optional for gain control

Electrical Performance – $V_{dd} = 10.0\text{ V}$, $V_{gg} = -0.55\text{ V}$, $T_A = 25\text{ }^\circ\text{C}$, $F = 10\text{ GHz}$

Parameter	Min	Typ	Max	Units
Frequency Range	DC – 20			GHz
Gain		12.5		dB
Noise Figure		3		dB
Input Return Loss		15		dB
Output Return Loss		15		dB
Output P1dB		28		dBm
Output IP3		39		dBm
Output IP2		38		dBm
Supply Current		400		mA

ver 1.2 1018



CMD249P5

DC-20 GHz Distributed Power Amplifier

Specifications

Absolute Maximum Ratings

Parameter	Rating
Drain Voltage, V _{dd}	10.5 V
Gate1 Voltage, V _{gg}	-2.0 to 0 V
RF Input Power	+30 dBm
Channel Temperature, T _{ch}	150 °C
Power Dissipation, P _{diss}	4.924 W
Thermal Resistance, Θ_{JC}	13.2 °C/W
Operating Temperature	-40 to 85 °C
Storage Temperature	-55 to 150 °C

Exceeding any one or combination of the maximum ratings may cause permanent damage to the device.

Recommended Operating Conditions

Parameter	Min	Typ	Max	Units
V _{dd}	8.0	10.0	10.5	V
I _{dd}	350	400	450	mA
V _{gg1}		-0.55		V

Electrical performance is measured at specific test conditions. Electrical specifications are not guaranteed over all recommended operating conditions.

Electrical Specifications – V_{dd} = 10.0 V, V_{gg} = -0.55 V, T_A = 25 °C

Parameter	Min	Typ	Max	Min	Typ	Max	Units
Frequency Range	DC – 6		6 – 20				GHz
Gain	8	11		9	13		dB
Noise Figure		5			3.5		dB
Input Return Loss		13			18		dB
Output Return Loss		9			13		dB
Output P1dB	25	28		20	27		dBm
Output IP3		42			38		dBm
Output IP2		40			40		dBm
Supply Current	350	400	450	350	400	450	mA
Gain Temperature Coefficient		0.008			0.012		dB/°C
Noise Figure Temperature Coefficient		0.01			0.012		dB/°C

ver 1.2 1018

Typical Performance

Broadband Performance, $V_{dd} = 10\text{ V}$, $V_{gg} = -0.55\text{ V}$, $I_{dd} = 380\text{ mA}$, $T_A = 25\text{ }^\circ\text{C}$

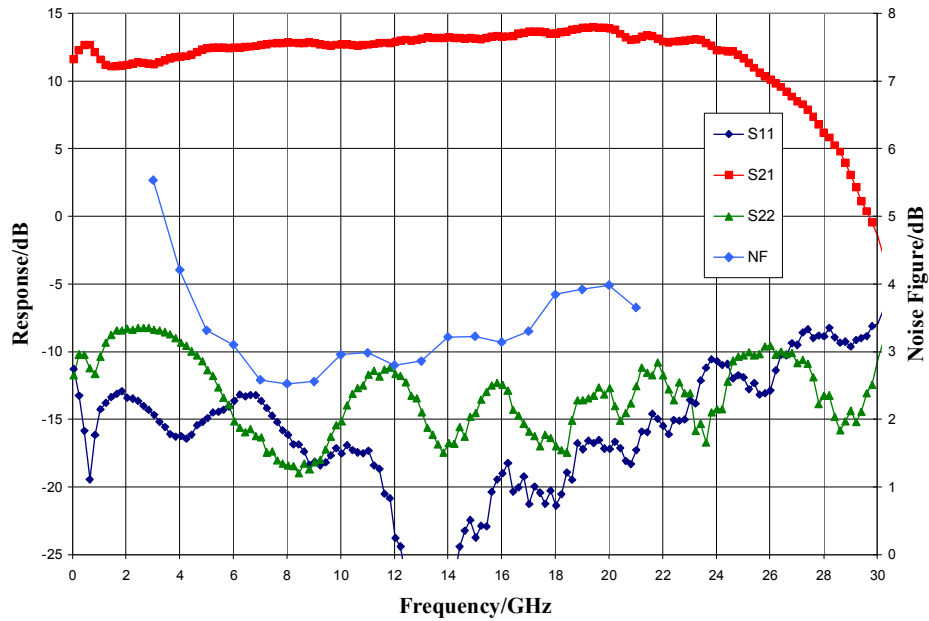

Narrow-band Performance, $V_{dd} = 10\text{ V}$, $V_{gg} = -0.55\text{ V}$, $I_{dd} = 380\text{ mA}$, $T=25\text{ }^\circ\text{C}$

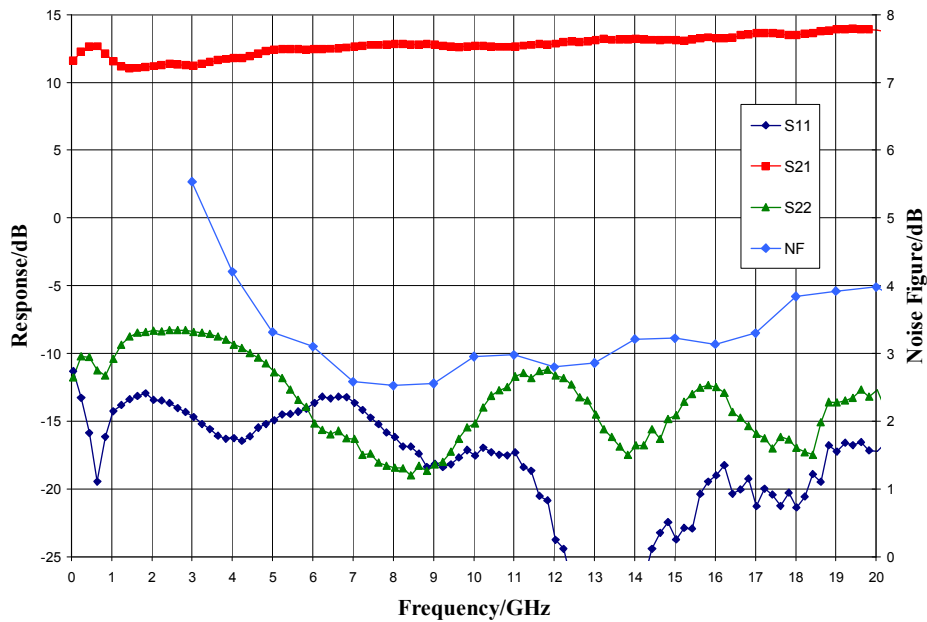

ver 1.2 1018

Typical Performance

Gain vs. Temperature, $V_{dd} = 10\text{ V}$, $V_{gg} = -0.55\text{ V}$

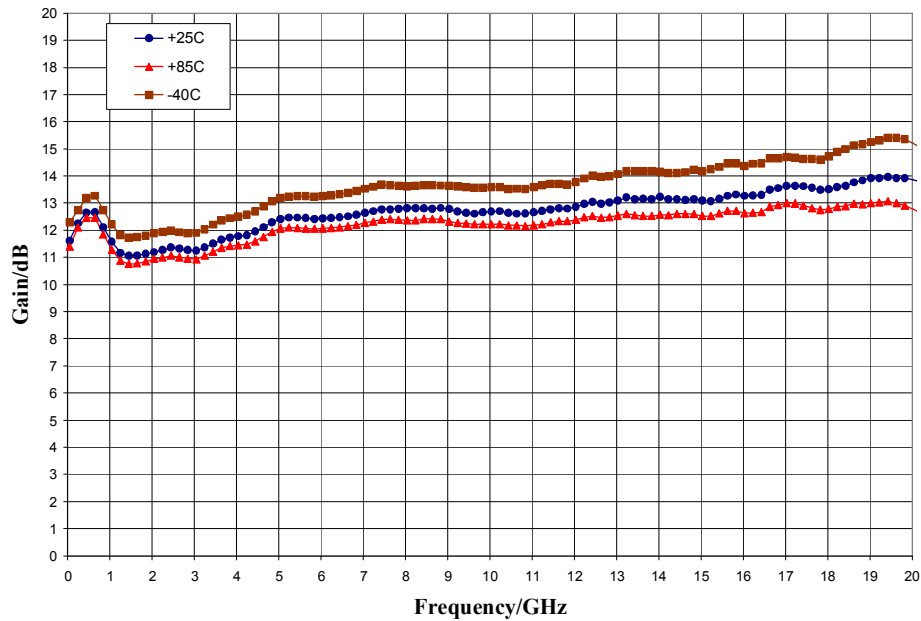

Gain vs. Vdd, $T_A = 25\text{ }^\circ\text{C}$

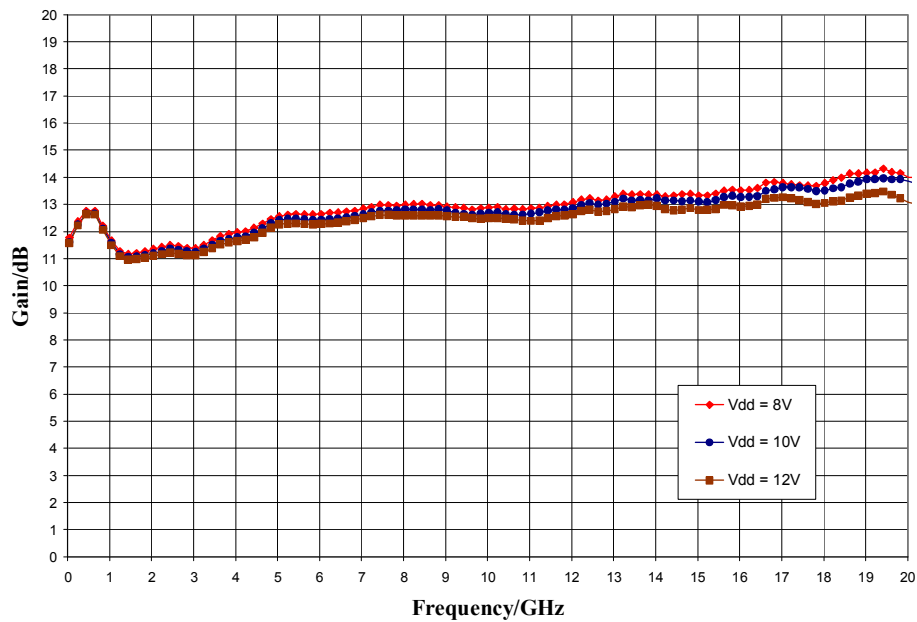

Typical Performance

Noise Figure vs. Temperature, $V_{dd} = 10\text{ V}$, $V_{gg} = -0.55\text{ V}$

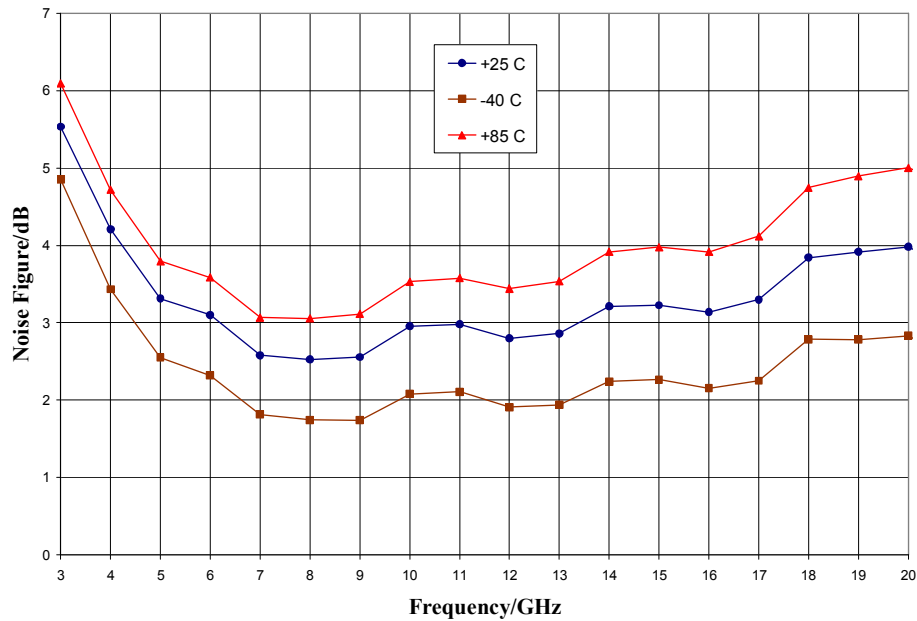

Noise Figure vs. V_{dd} , $T_A = 25\text{ }^\circ\text{C}$

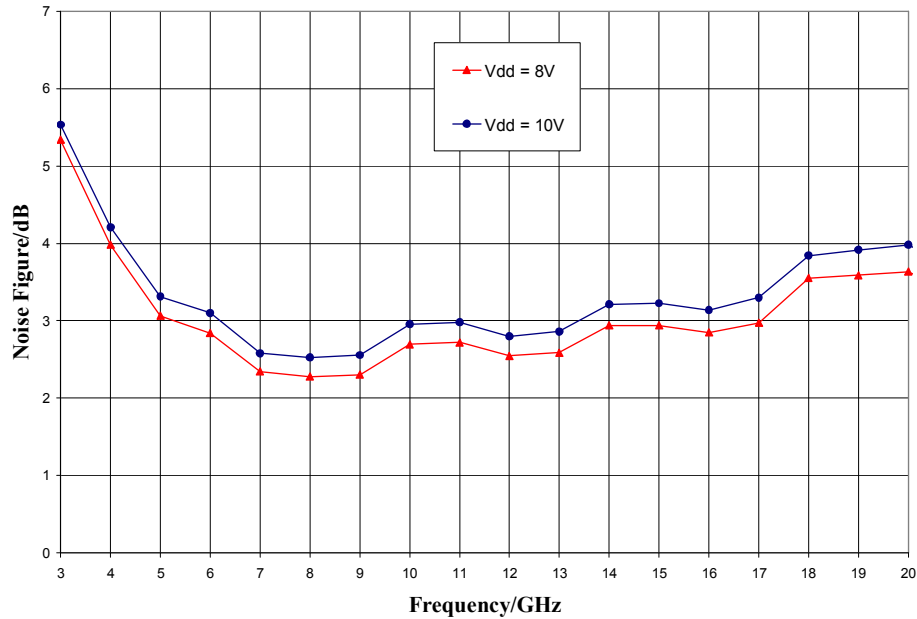

ver 1.2 1018

Typical Performance

Output Power, $V_{dd} = 10\text{ V}$, $V_{gg} = -0.55\text{ V}$, $T_A = 25\text{ }^\circ\text{C}$

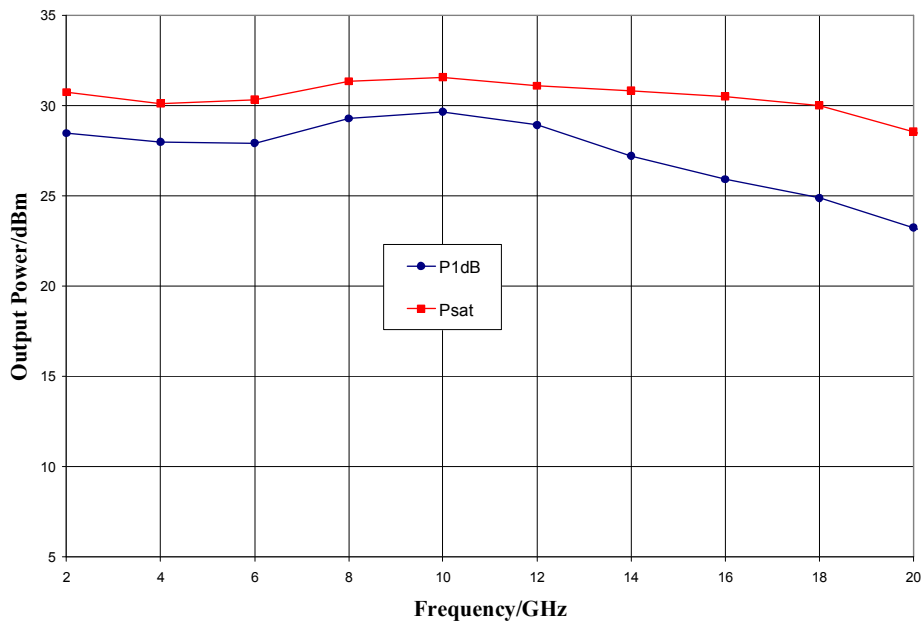

P1dB vs. Temperature, $V_{dd} = 10\text{ V}$, $V_{gg} = -0.55\text{ V}$

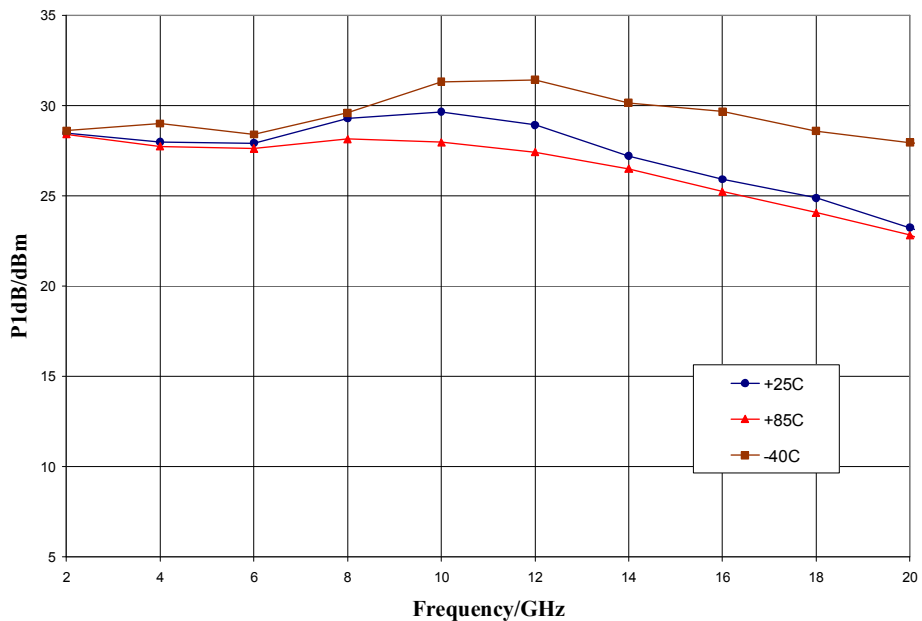

Typical Performance

P1dB vs. Vdd, T_A = 25 °C

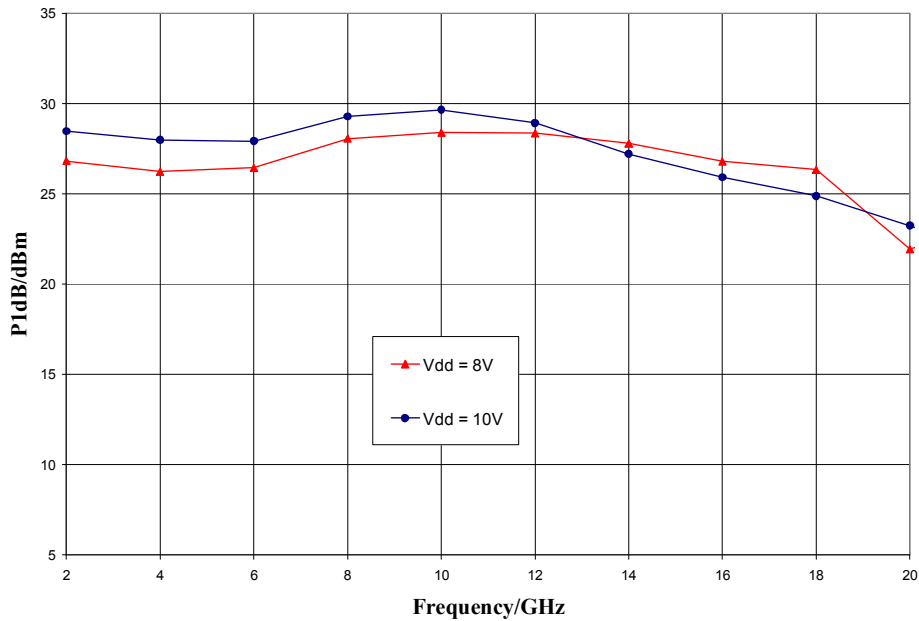

Output IP3 vs. Temperature, V_{dd} = 10 V, V_{gg} = -0.55 V

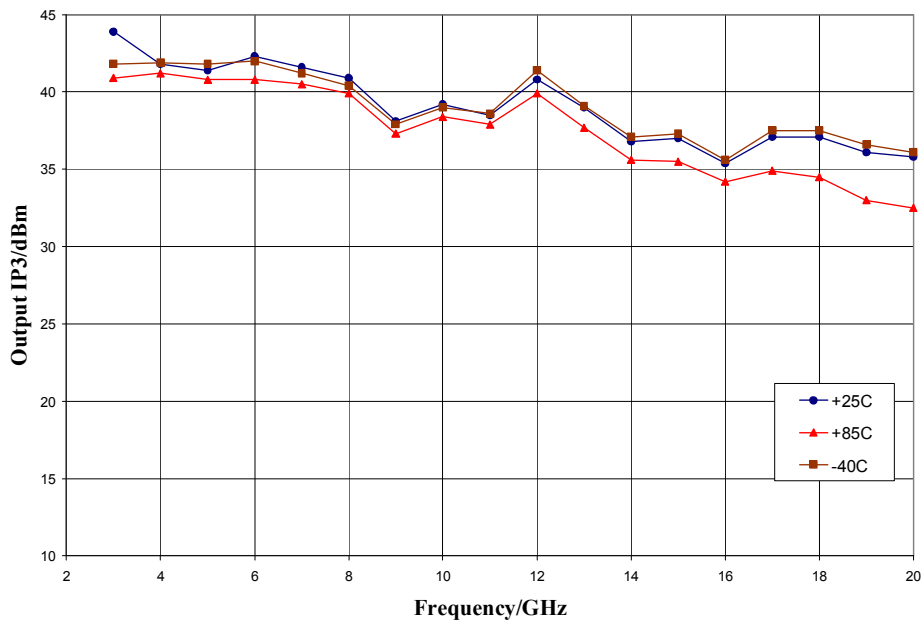

ver 1.2 1018

Typical Performance

Output IP2, $V_{dd} = 10\text{ V}$, $V_{gg} = -0.55\text{ V}$

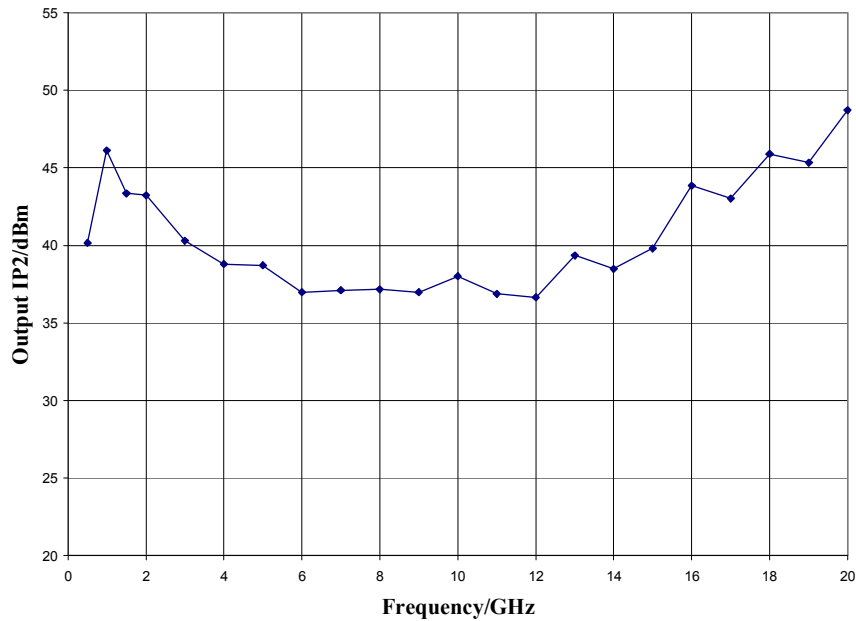

Mechanical Information

Package Information and Dimensions

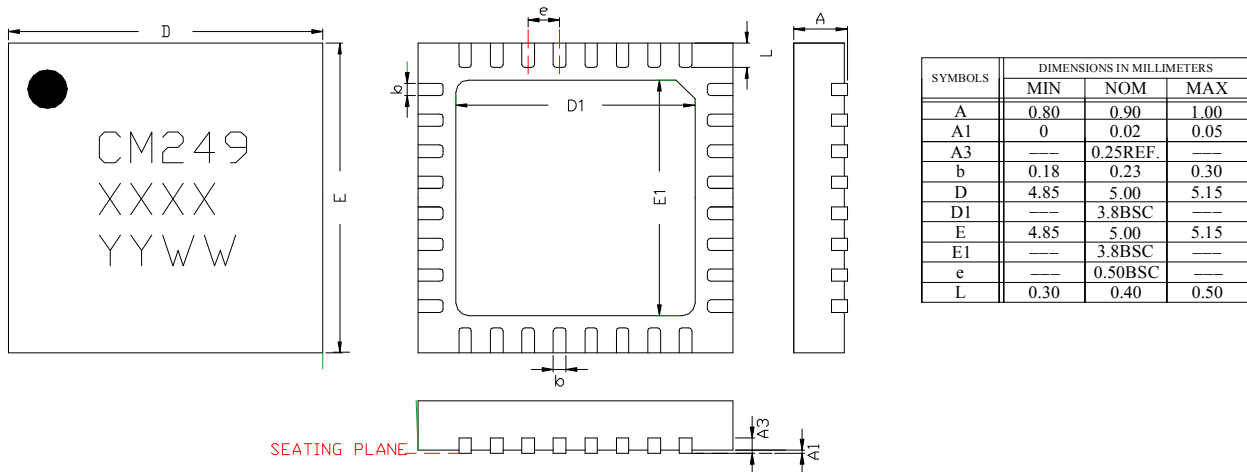

- NOTES:
1. DIMENSIONS ARE IN MILLIMETERS
 2. RoHS COMPLIANT MOLD COMPOUND
 3. LEADFRAME MATERIAL: COPPER ALLOY
 4. LEAD FINISH: 100% MATTE Sn
 5. INDICATED DIMENSION/TOLERANCE APPLIES TO LEADS AND EXPOSED PAD

Recommended PCB Land Pattern

Custom MMIC Design Services recommends that the user develop the land pattern that will provide the best design for proper solder reflow and device attach for their specific application. Please review CMDS Application Note AN 105 for a recommended land pattern approach.

Recommended Solder Reflow Profile



Custom MMIC Design Services recommends screen printing with belt furnace reflow to ensure proper solder reflow and device attach. Please review CMDS Application Note AN 102 for a recommended solder reflow profile.

Pin Description

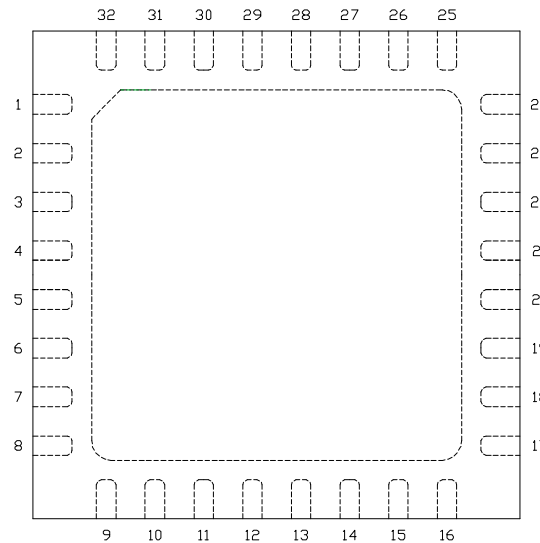
Pin Diagram

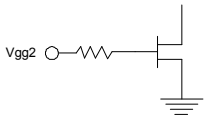

Functional Description

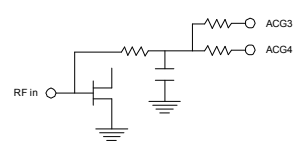
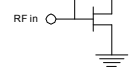
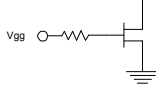
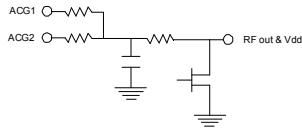
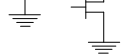
Pin	Function	Description	Schematic
1, 3, 7-12, 14, 17-19, 23-28, 31, 32	N/C	No connection required. These pins may be connected to RF/DC ground	
2	Vgg2	Optional supply voltage for gain control Decoupling and bypass caps required Pin must be left open if unused	
4, 6, 20, 22 and die paddle	Ground	Connect to RF / DC ground	
5	RF in	50 ohm matched input	
15, 16	ACG4, 3	Low frequency termination. Attach bypass capacitor per application circuit	
13	Vgg	Power supply voltage Decoupling and bypass caps required	
21	RF out & Vdd	Power supply voltage and 50 ohm matched output	
29, 30	ACG2, 1	Low frequency termination. Attach bypass capacitor per application circuit	

ver 1.2 1018

Applications Information

Evaluation Board

The circuit board shown has been developed for optimized assembly at CMDS. A sufficient number of via holes should be used to connect the top and bottom ground planes. As surface mount processes vary, careful process development is recommended.

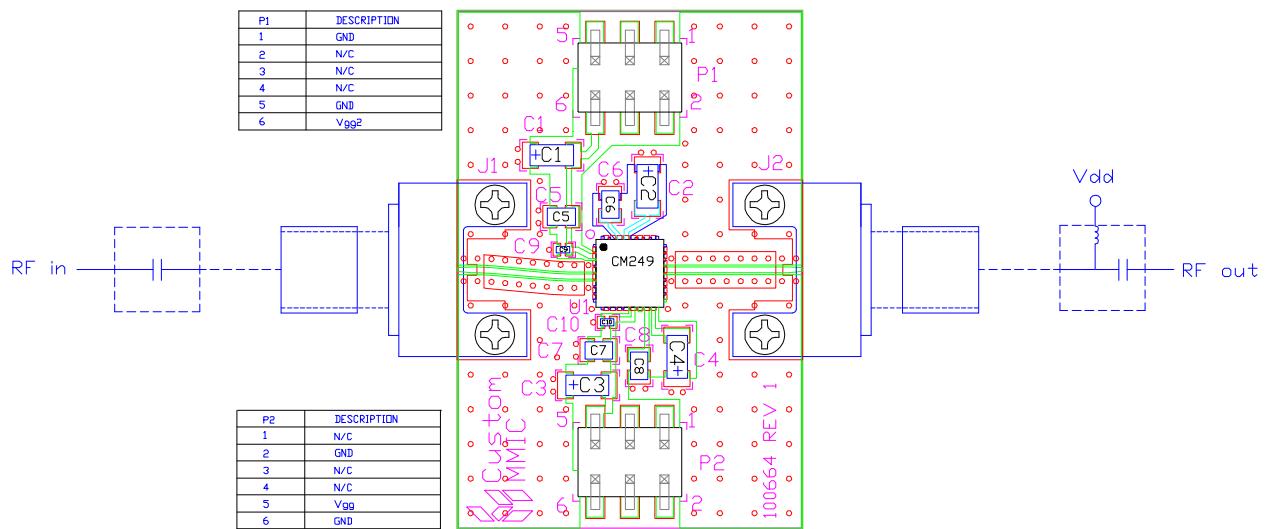

Bill of Material

Designator	Value	Description
J1, J2		SMA End Launch Connector
P1, P2		6 Pin DC Header
C1 - C4	0.33 μ F	Capacitor, Tantalum
C5 - C8	1000 pF	Capacitor, 0603
C9, C10	100 pF	Capacitor, 0402
U1		CMD249P5 Driver Amplifier
PCB		100664 Evaluation PCB

GaAs MMIC devices are susceptible to damage from Electrostatic Discharge. Proper precautions should be observed during handling, assembly and test.

Applications Information

Application Circuit

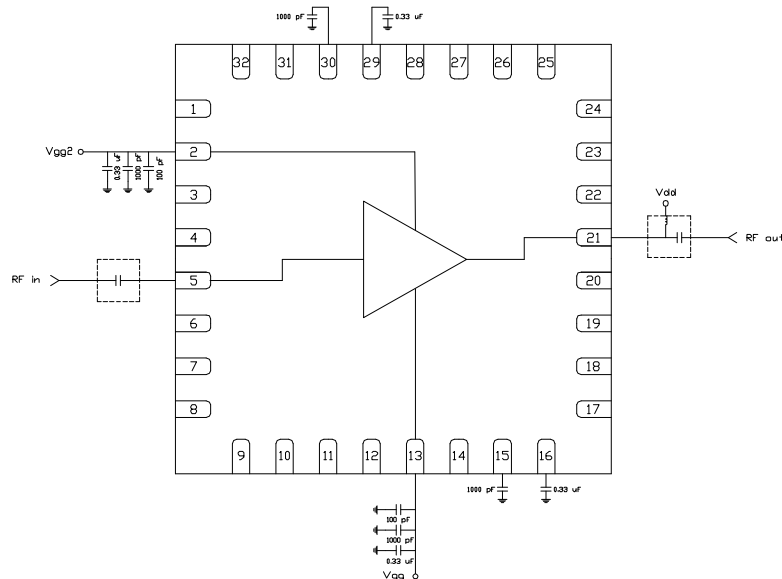

Note: Drain voltage (Vdd) must be applied through a broadband bias tee or external bias network. External DC block is required on RF input.

Biasing and Operation

The CMD249P5 is biased with a positive drain supply and a negative gate supply. Performance is optimized when the drain voltage is set to +10 V. The nominal gate voltage is -0.55 V.

Turn ON procedure:

1. Apply gate voltage V_{gg} and set to -2 V
2. Apply drain voltage V_{dd} and set to +10 V
3. Increase V_{gg} (less negative) to achieve a drain current of 400 mA

Turn OFF procedure:

1. Turn off drain voltage V_{dd}
2. Turn off gate voltage V_{gg}

RF power can be applied at any time.

Mouser Electronics

Authorized Distributor

Click to View Pricing, Inventory, Delivery & Lifecycle Information:

Qorvo:

[CMD249P5](#) [CMD249P5-EVB](#)