

### Product Overview

Qorvo's QPA2610 is a packaged, high performance power amplifier fabricated on Qorvo's production 0.15 um GaN on SiC process (QGaN15). Covering 8.5-10.5 GHz, the QPA2610 provides > 2 W of saturated output power and 23 dB of large-signal gain while achieving an impressive 47% power-added efficiency.

Packaged in a small 5 x 5 mm plastic overmold QFN, tight lattice spacing requirements for phased array radar applications is easily supported. RF input and output ports are matched to 50Ω and include integrated DC blocking capacitors. QPA2610 is part of a three-amplifier family and is pin compatible to QPA2612 and QPA2611.

Lead-free and RoHS compliant.

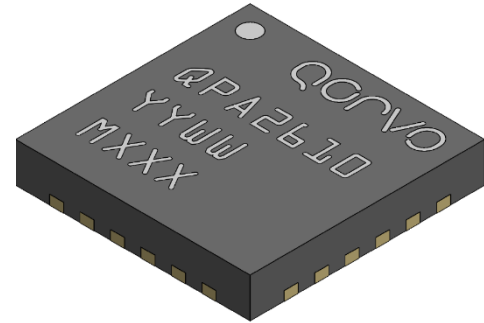

5 mm x 5 mm plastic overmold QFN

### Key Features

- Frequency Range: 8.5 – 10.5 GHz
- Output Power ( $P_{IN} = 10 \text{ dBm}$ ): > 33 dBm
- PAE ( $P_{IN} = 10 \text{ dBm}$ ): > 47 %
- Small Signal Gain: > 37.5 dB
- Input Return Loss: > 14 dB
- Output Return Loss: > 12 dB
- Recommended Bias:  $V_D = 20 \text{ V}$ ,  $I_{DQ} = 56 \text{ mA}$
- Package Size: 5.0 mm x 5.0 mm x 0.85 mm

### Functional Block Diagram

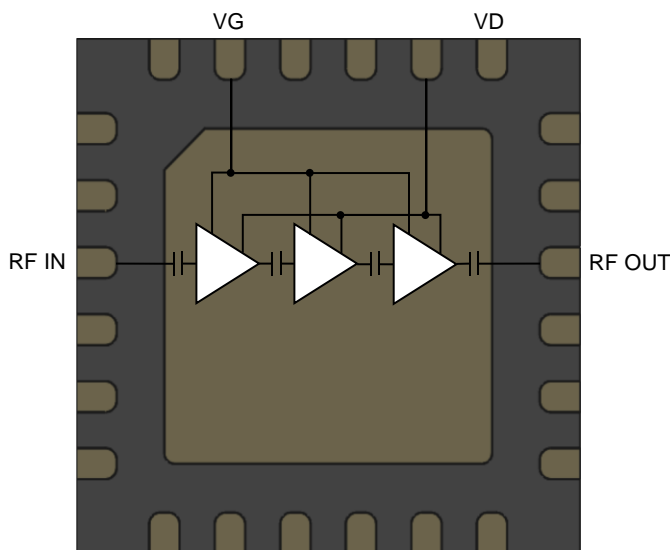

Top View

### Applications

- Radar
- Communications
- Satcom

### Ordering Information

Part No.	Description
QPA2610	2 Watt X-Band Power Amplifier
QPA2610TR7	500 pcs. on 7 inch reel
QPA2610EVB	QPA2610 Evaluation Board

## Absolute Maximum Ratings

Parameter	Rating
Drain Voltage ( $V_D$ )	29.5 V
Gate Voltage Range ( $V_G$ )	-4 to 0 V
Drain Current ( $I_D$ )	700 mA
Gate Current ( $I_G$ )	See plot pg. 16
Power Dissipation ( $P_{DISS}$ ), $T_{BASE} = 85\text{ }^\circ\text{C}$	8.8 W
Input Power ( $P_{IN}$ ), Pulsed (100us/10%), 50 $\Omega$ , $V_D = 20\text{ V}$ , $T_{BASE} = 85\text{ }^\circ\text{C}$	18 dBm
Input Power ( $P_{IN}$ ), Pulsed (100us/10%), VSWR 3:1, $V_D = 20\text{ V}$ , $T_{BASE} = 85\text{ }^\circ\text{C}$	18 dBm
Mounting Temperature (30 seconds max.)	260 $^\circ\text{C}$
Storage Temperature	-55 to 150 $^\circ\text{C}$

Exceeding any one or a combination of the Absolute Maximum Rating conditions may cause permanent damage to the device. Extended application of Absolute Maximum Rating conditions to the device may reduce device reliability.

## Recommended Operating Conditions

Parameter	Typ
Drain Voltage ( $V_D$ )	20 V
Drain Current ( $I_{DQ}$ )	56 mA
Drain Current Under RF Drive ( $I_{D\_DRIVE}$ )	See plots pg. 4
Gate Voltage Range ( $V_G$ )	-2.8 to -2.0 V
Gate Current Under RF Drive ( $I_{G\_DRIVE}$ )	See plots pg. 4

Electrical specifications are measured at specified test conditions. Specifications are not guaranteed over all recommended operating conditions.

## Electrical Specifications

Parameter	Conditions	Min	Typ	Max	Units
Operational Frequency		8.5		10.5	GHz
Output Power ( $P_{IN} = 10\text{ dBm}$ )	Pulsed $V_D$		33.9		dBm
Power Added Efficiency ( $P_{IN} = 10\text{ dBm}$ )	Pulsed $V_D$		47.4		%
Small Signal Gain (CW)			38.5		dB
Input Return Loss (CW)			19		dB
Output Return Loss (CW)			14		dB
3 <sup>RD</sup> Order IMD ( $P_{IN}/\text{Tone} = 0\text{ dBm}$ )	10 MHz tone spacing		-15		dBc
$P_{OUT}$ Temp. Coeff. (85 $^\circ\text{C}$ to 25 $^\circ\text{C}$ , $P_{IN} = 10\text{ dBm}$ )			-0.21		dB/ $^\circ\text{C}$
Sm. Sig. Gain Temp. Coefficient (85 $^\circ\text{C}$ to -40 $^\circ\text{C}$ )			-0.09		dB/ $^\circ\text{C}$
Gate Leakage Current	$V_D = 10\text{ V}$ , $V_G = -3.7\text{ V}$	-1.23			mA

Test conditions, unless otherwise noted:  $T = +25\text{ }^\circ\text{C}$ ,  $V_D = 20\text{ V}$ ,  $I_{DQ} = 56\text{ mA}$ , Pulse Width = 100 us, Duty Cycle = 10%

## Performance Plots – Large Signal (Pulsed)

Test conditions unless otherwise noted:  $T = +25\text{ }^{\circ}\text{C}$ ,  $V_D = 20\text{ V}$ ,  $I_{DQ} = 56\text{ mA}$ ,  $P_{IN} = 10\text{ dBm}$ , Pulse Width = 100  $\mu\text{s}$ , Duty Cycle = 10%

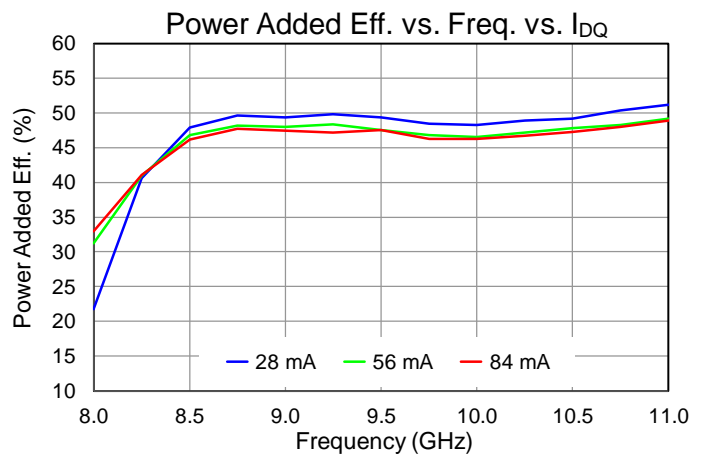
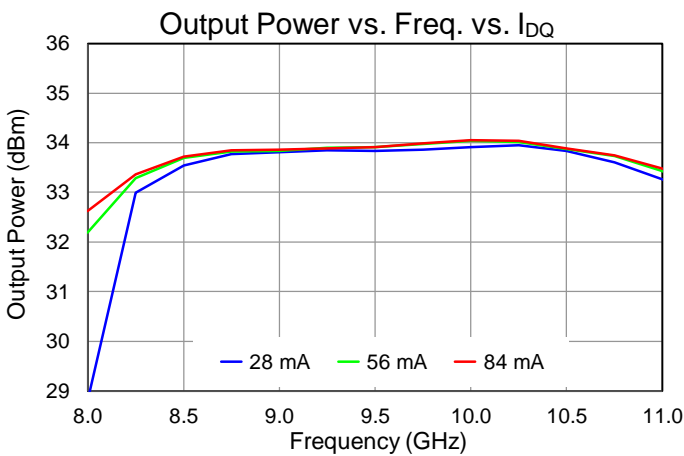
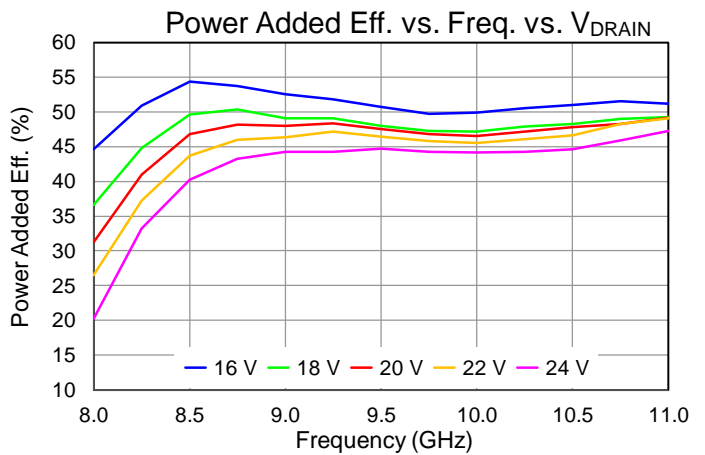
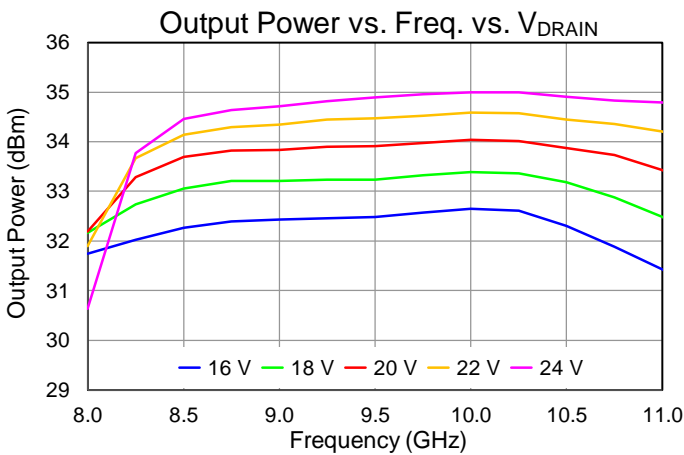
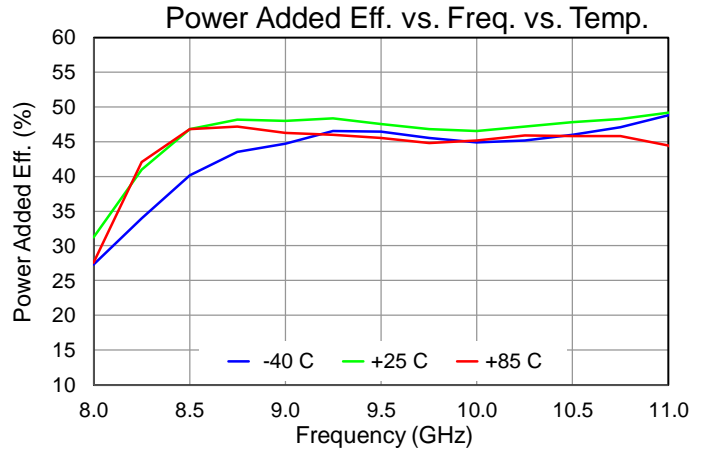
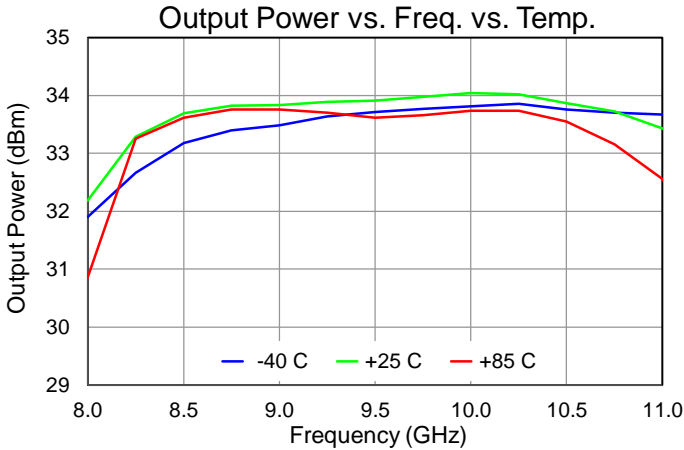

Performance Plots – Large Signal (Pulsed)

Test conditions unless otherwise noted: T = +25 °C, V<sub>D</sub> = 20 V, I<sub>DQ</sub> = 56 mA, P<sub>IN</sub> = 10 dBm, Pulse Width = 100 us, Duty Cycle = 10%

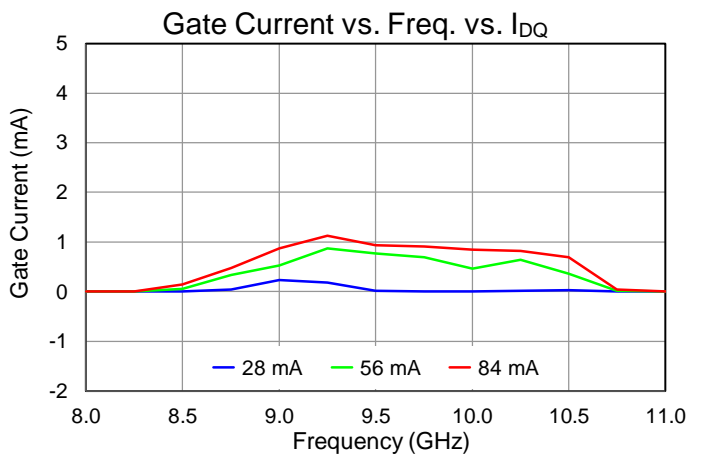
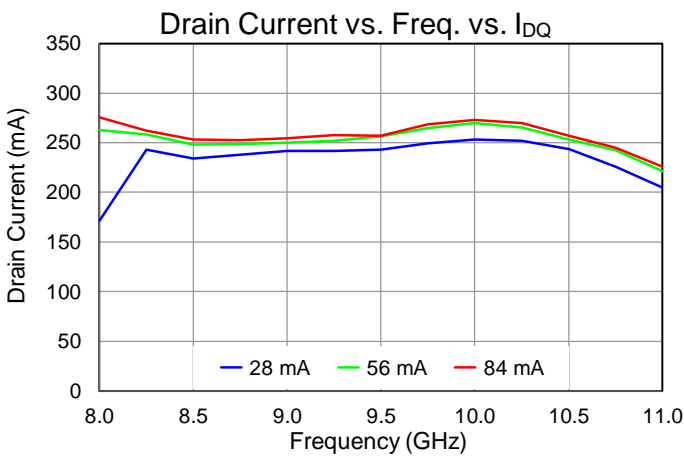
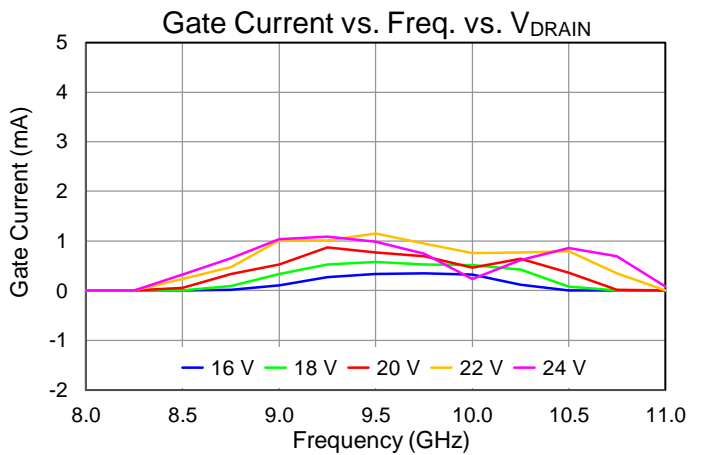
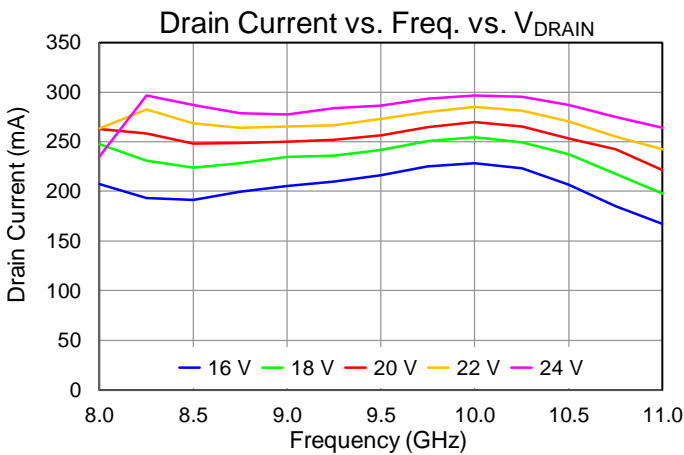
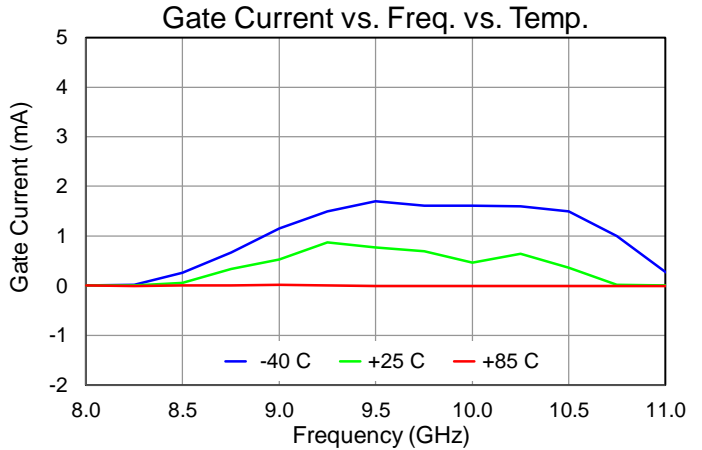
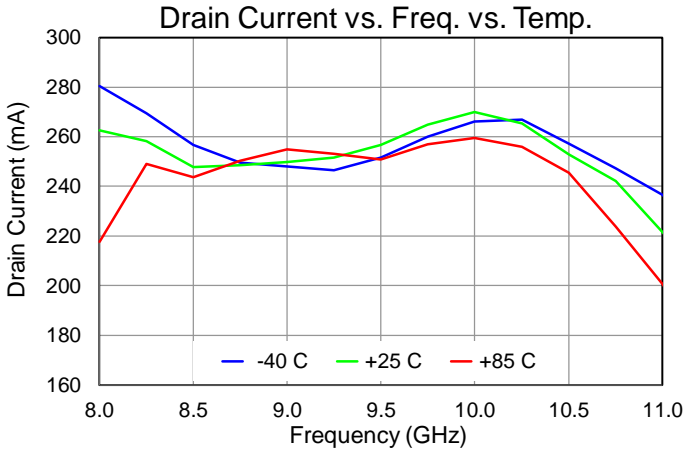

**Performance Plots – Large Signal (Pulsed)**

Test conditions unless otherwise noted:  $T = +25\text{ }^{\circ}\text{C}$ ,  $V_D = 20\text{ V}$ ,  $I_{DQ} = 56\text{ mA}$ , Pulse Width = 100  $\mu\text{s}$ , Duty Cycle = 10%

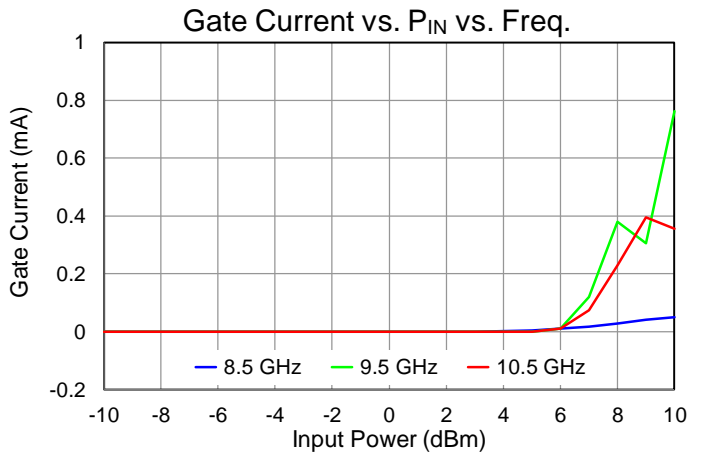
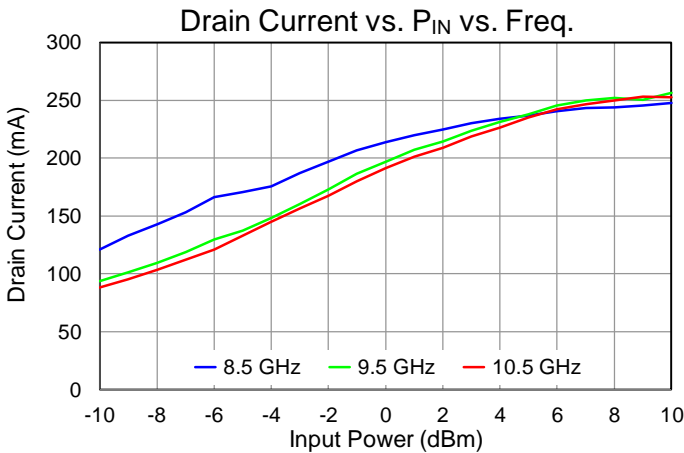
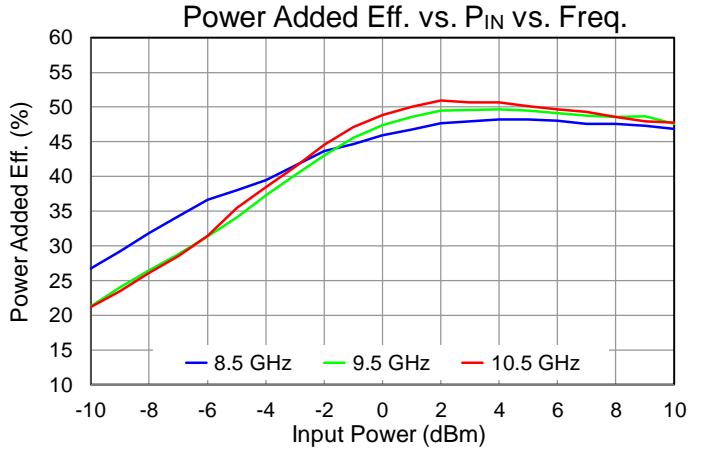
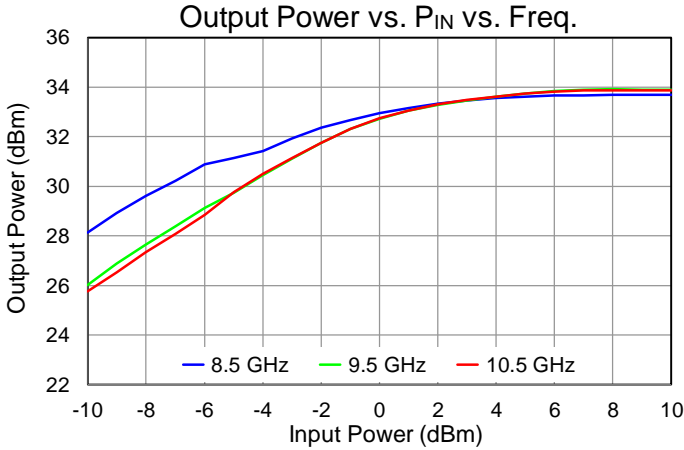

Performance Plots – Large Signal (Pulsed)

Test conditions unless otherwise noted: T = +25 °C, V<sub>D</sub> = 20 V, I<sub>DQ</sub> = 56 mA, Pulse Width = 100 us, Duty Cycle = 10%

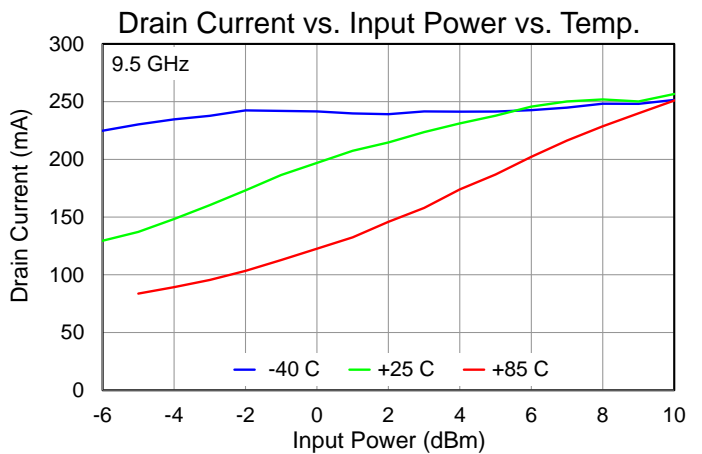
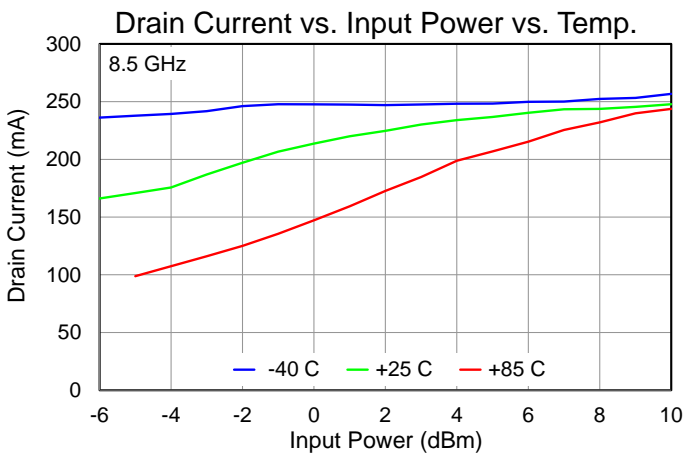
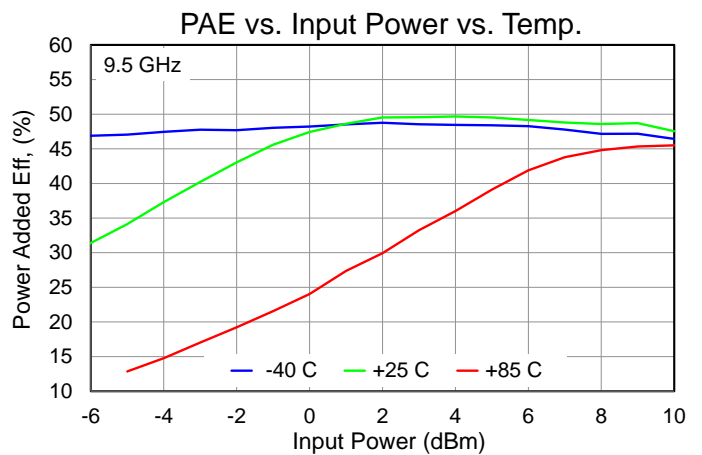
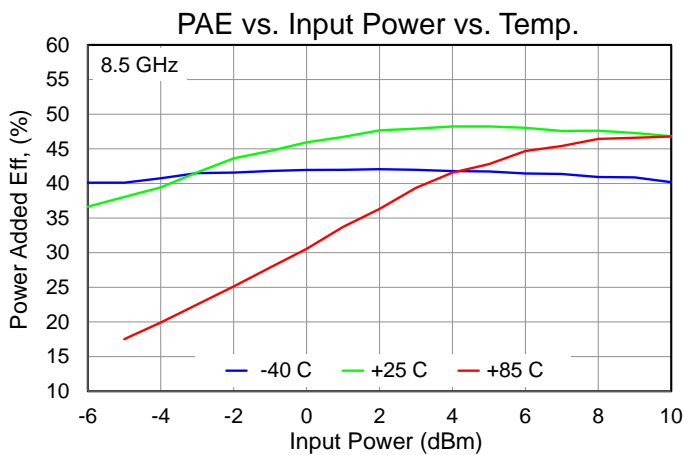
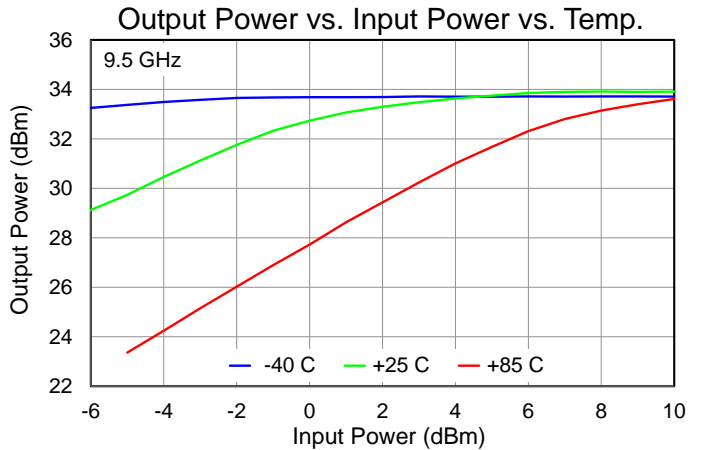
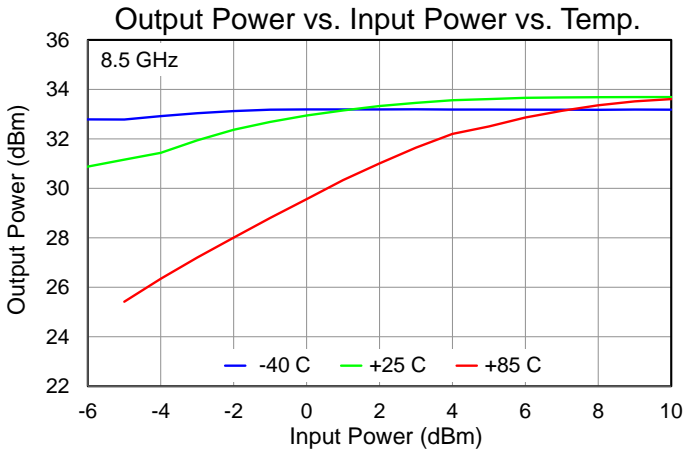

Performance Plots – Large Signal (Pulsed)

Test conditions unless otherwise noted: T = +25 °C, V<sub>D</sub> = 20 V, I<sub>DQ</sub> = 56 mA, Pulse Width = 100 us, Duty Cycle = 10%

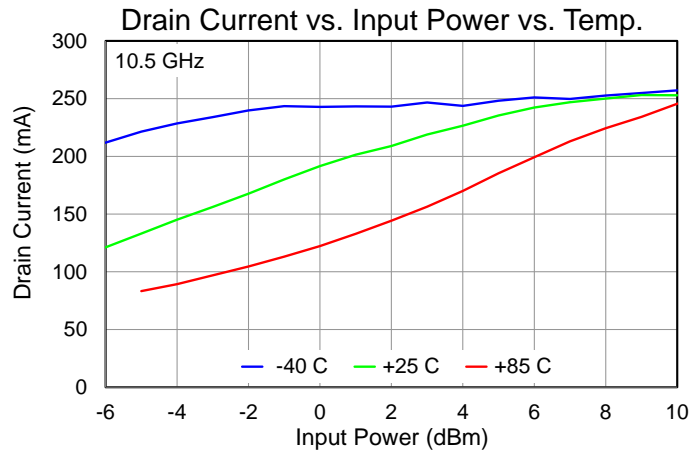
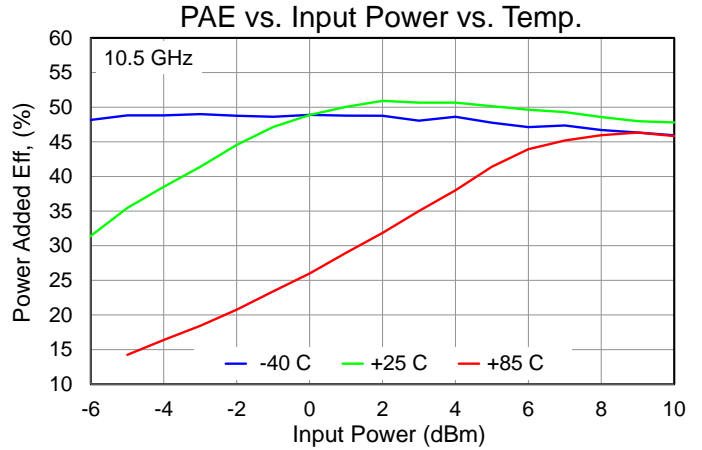
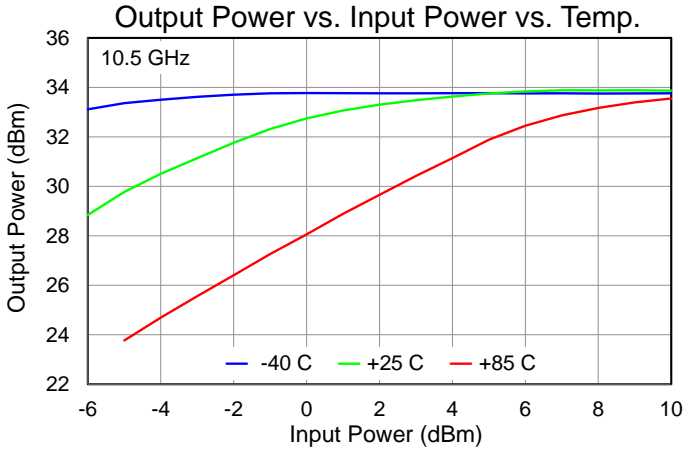

## Performance Plots – Large Signal (Pulsed)

Test conditions unless otherwise noted:  $T = +25\text{ }^{\circ}\text{C}$ ,  $V_D = 20\text{ V}$ ,  $I_{DQ} = 56\text{ mA}$ , Pulse Width = 100  $\mu\text{s}$ , Duty Cycle = 10%

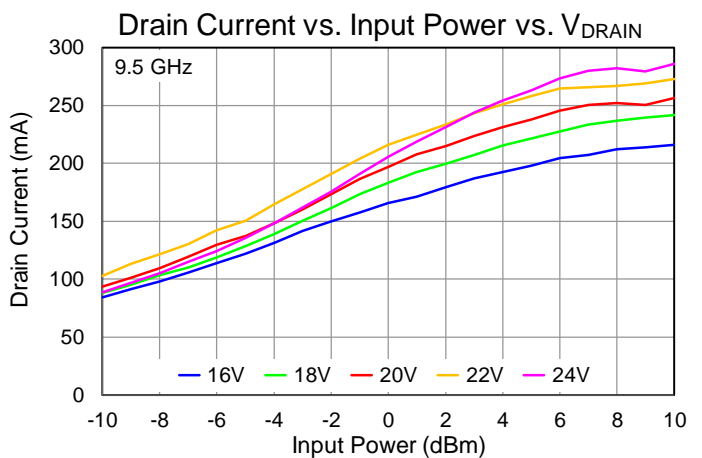
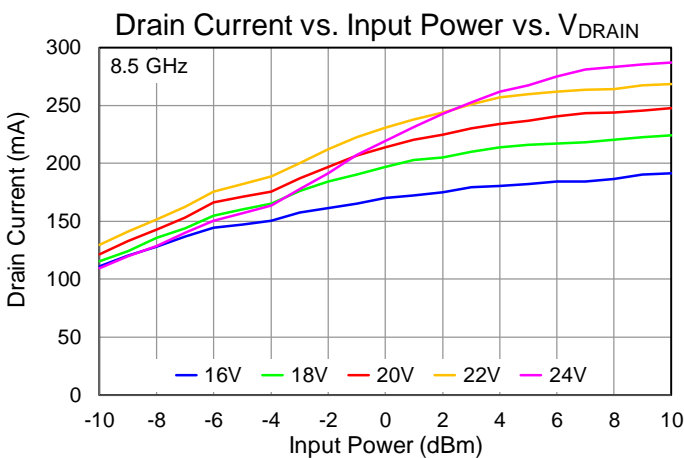
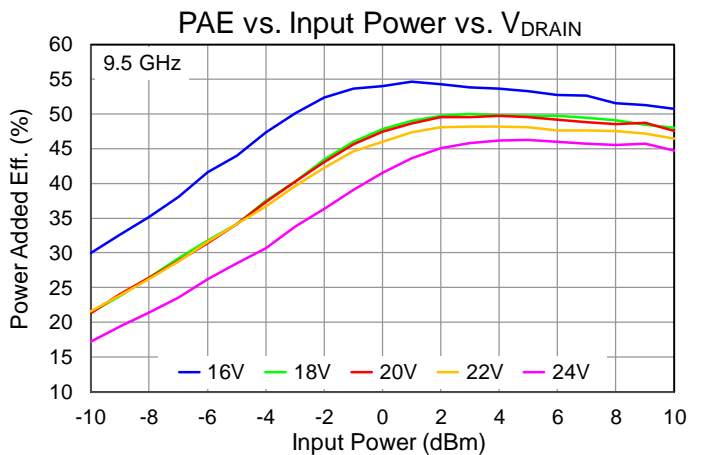
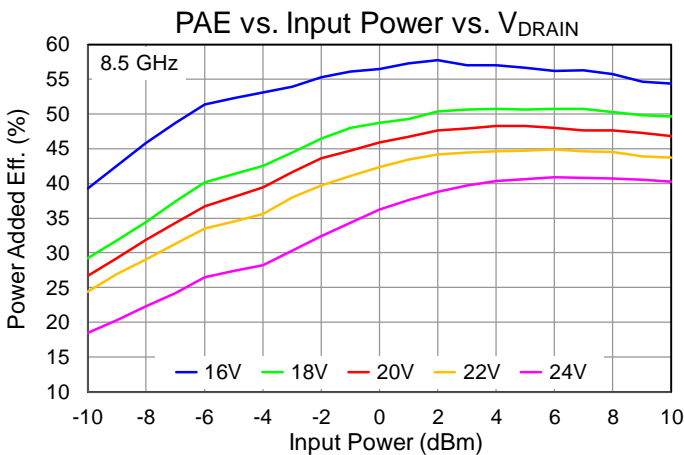
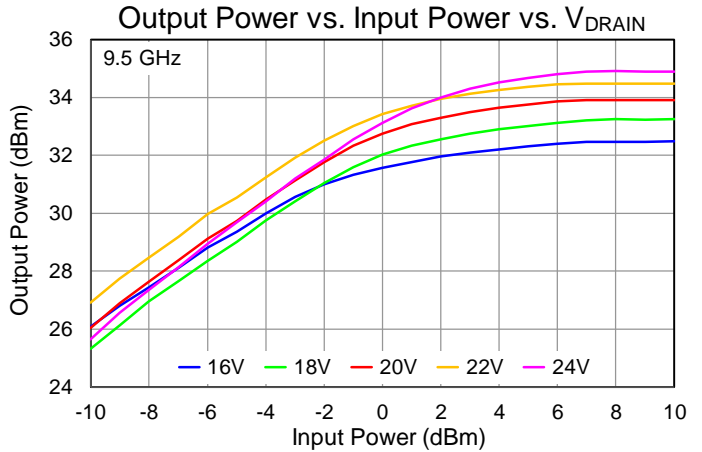
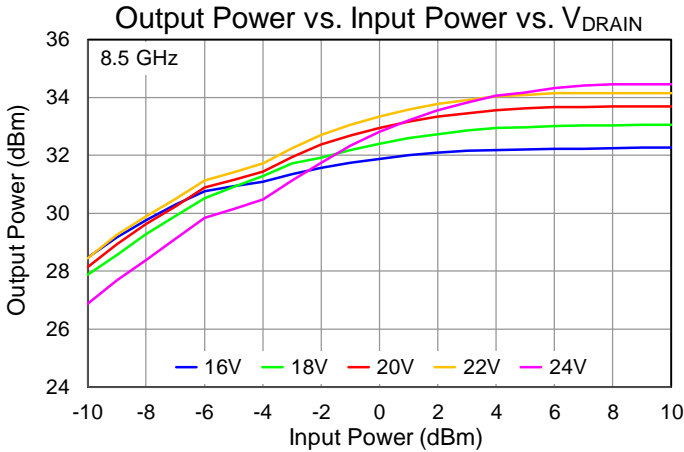



Performance Plots – Large Signal (Pulsed)

Test conditions unless otherwise noted: T = +25 °C, V<sub>D</sub> = 20 V, I<sub>DQ</sub> = 56 mA, Pulse Width = 100 us, Duty Cycle = 10%

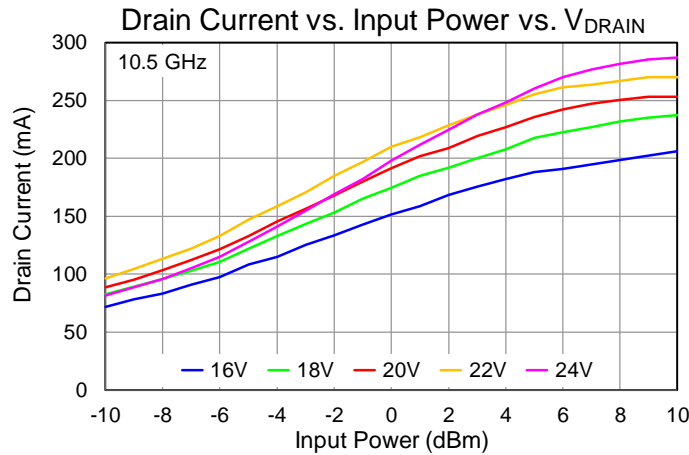
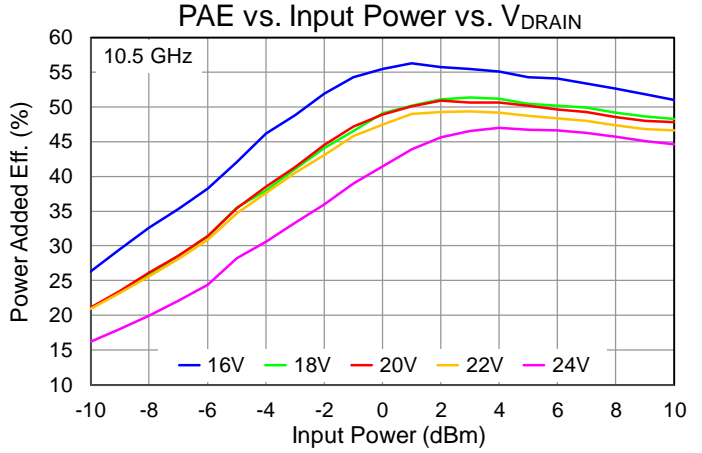
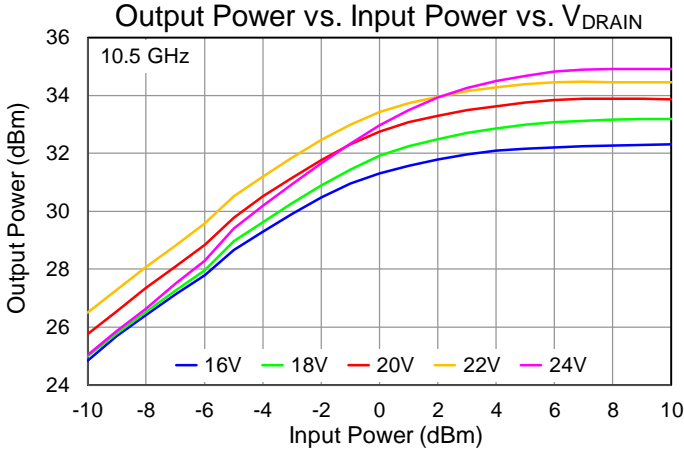

## Performance Plots – Large Signal (Pulsed)

Test conditions unless otherwise noted:  $T = +25\text{ }^{\circ}\text{C}$ ,  $V_D = 20\text{ V}$ ,  $I_{DQ} = 56\text{ mA}$ , Pulse Width = 100  $\mu\text{s}$ , Duty Cycle = 10%

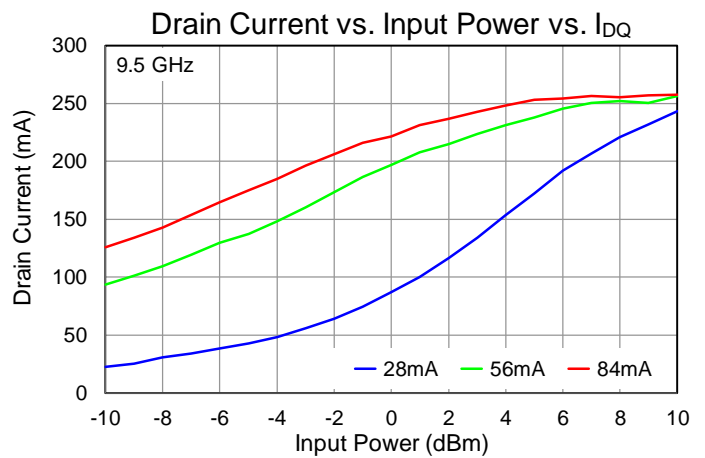
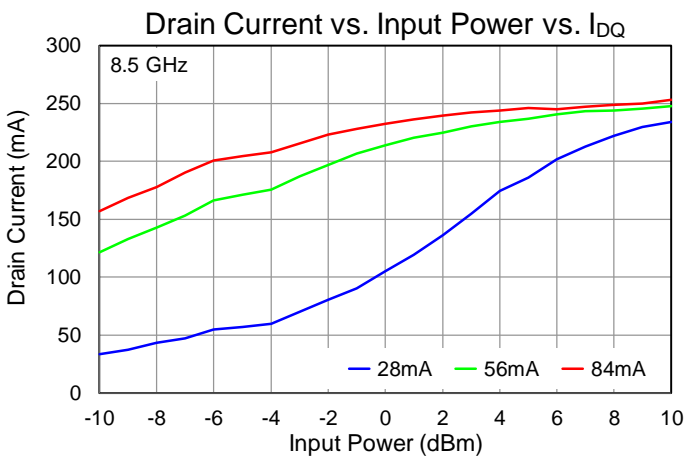
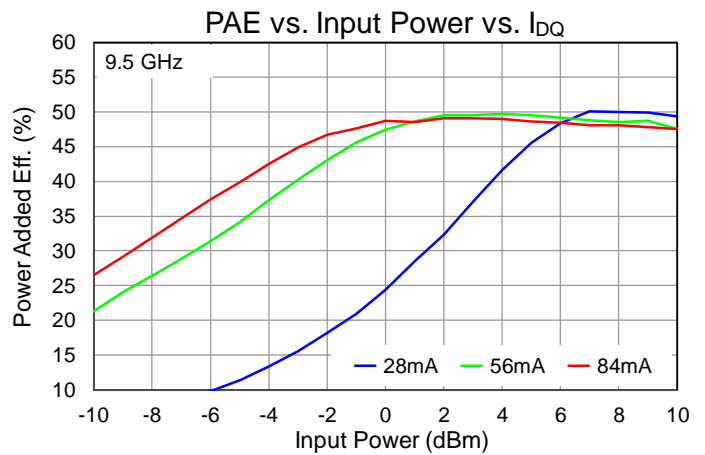
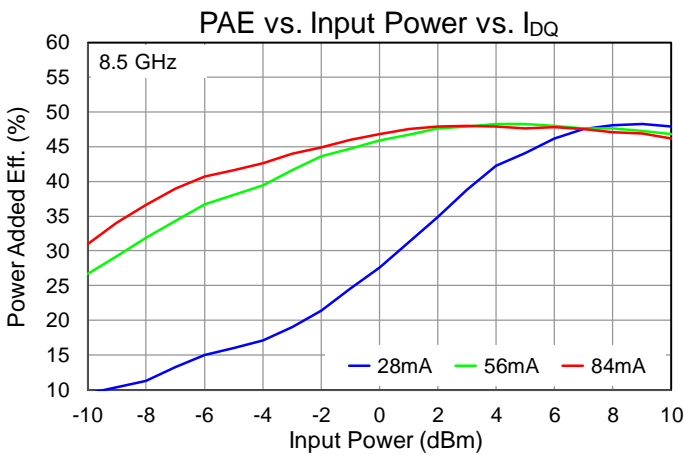
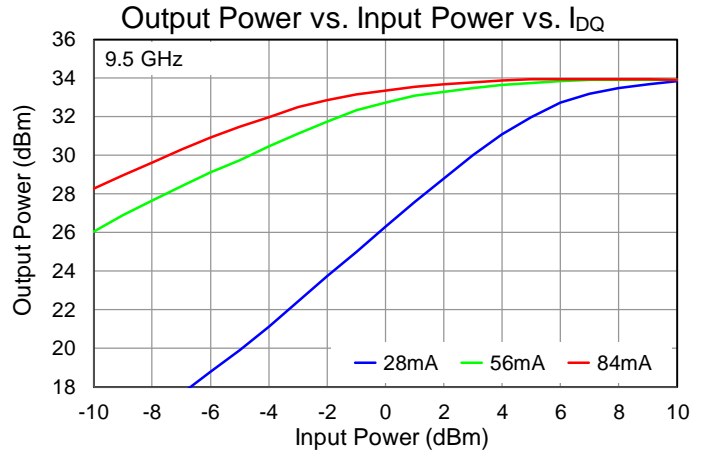
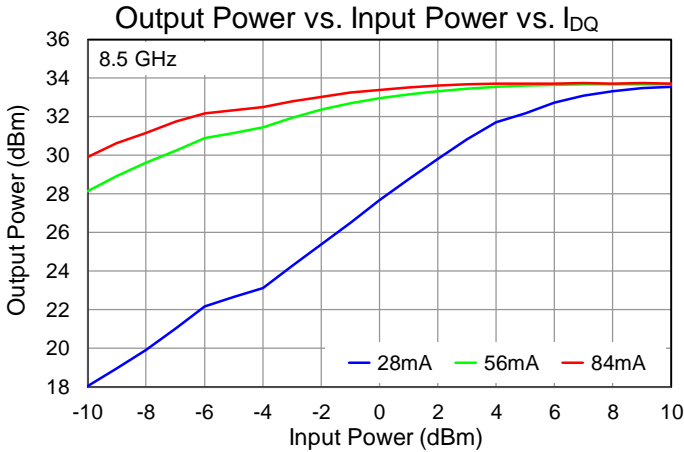

Performance Plots – Large Signal (Pulsed)

Test conditions unless otherwise noted: T = +25 °C, V<sub>D</sub> = 20 V, I<sub>DQ</sub> = 56 mA, Pulse Width = 100 us, Duty Cycle = 10%

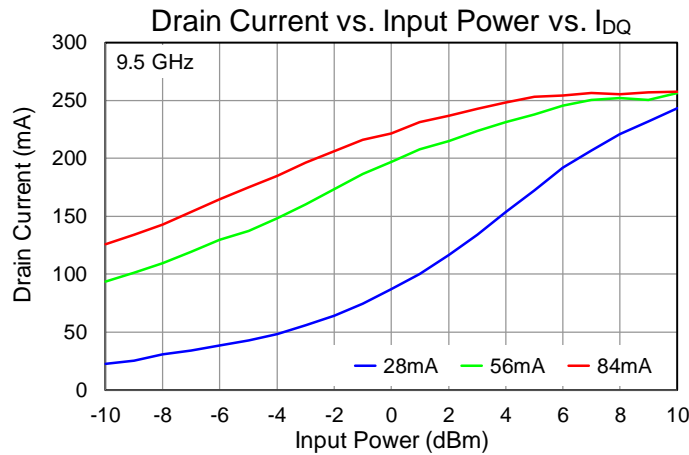
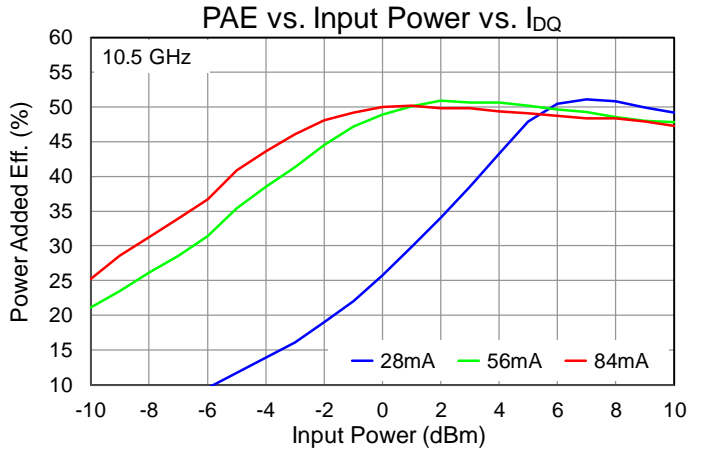
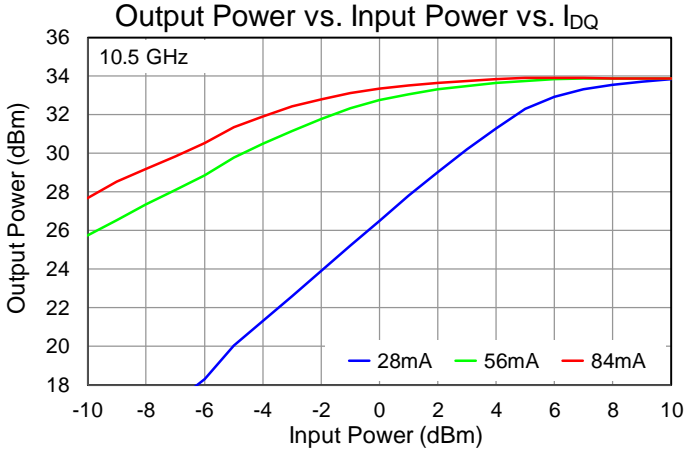

Performance Plots – Linearity

Test conditions unless otherwise noted:  $V_D = 20\text{ V}$ ,  $I_{DQ} = 56\text{ mA}$ ,  $T = 25\text{ }^\circ\text{C}$ , 10 MHz Tone Spacing, CW

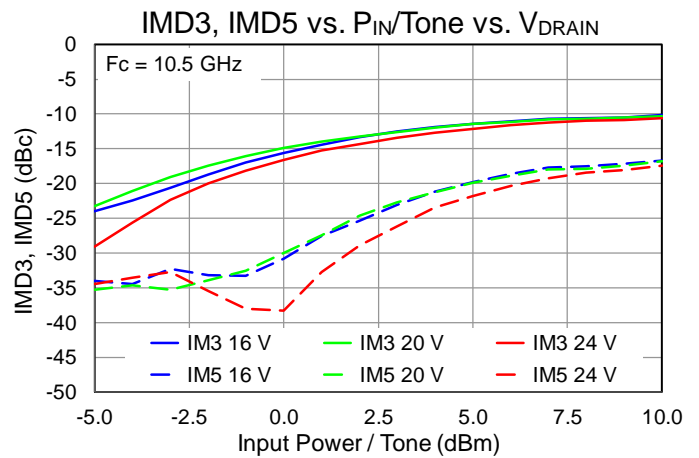
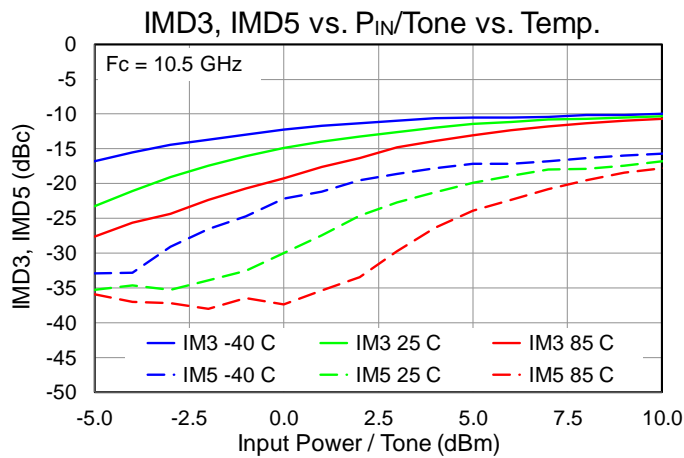
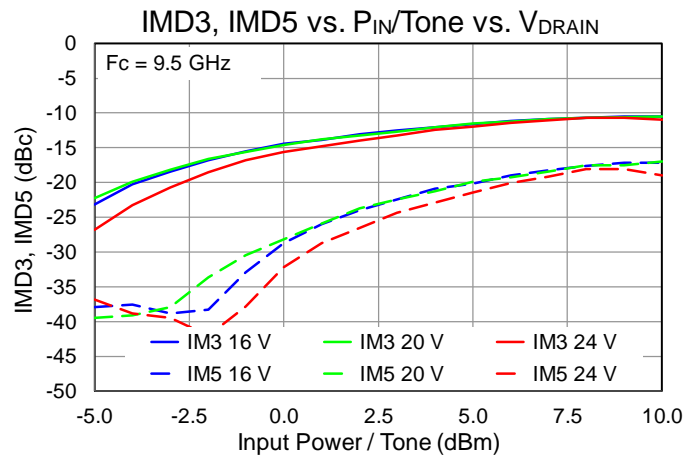
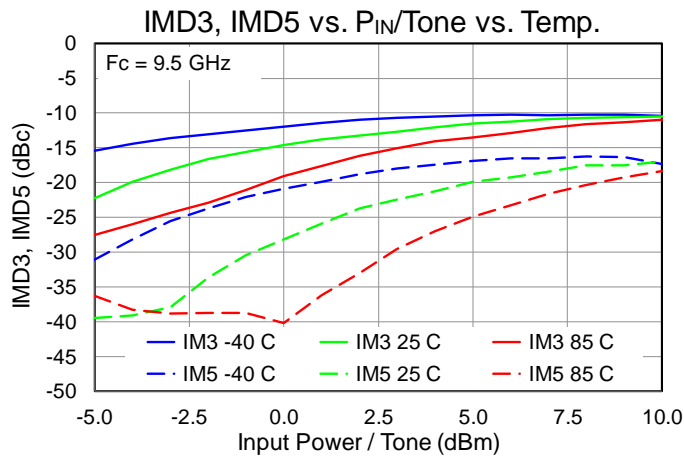
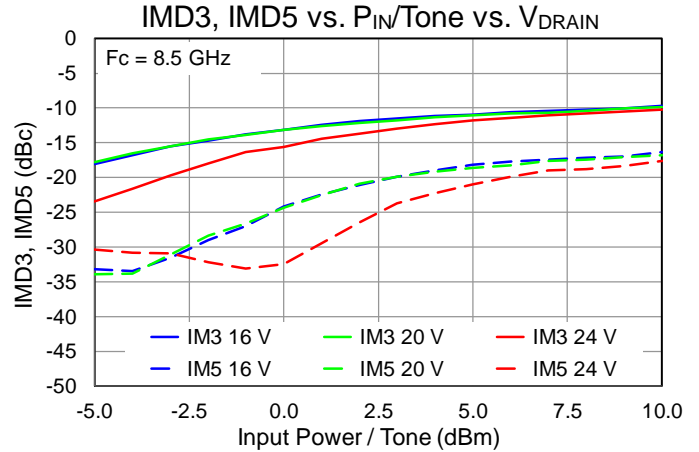
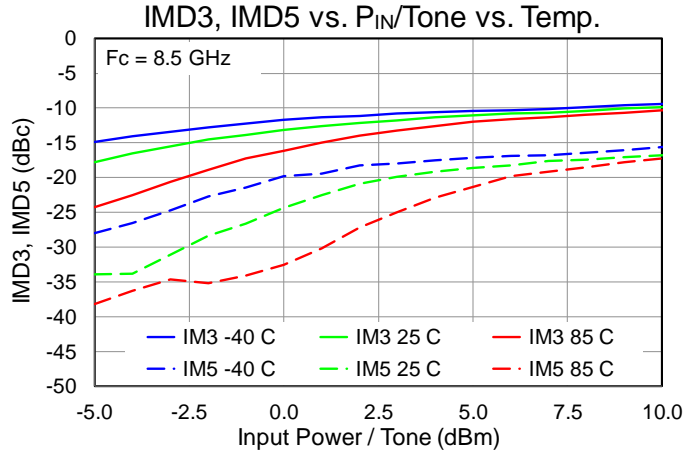

Performance Plots – Harmonics

Test conditions unless otherwise noted: T = +25 °C, V<sub>D</sub> = 20 V, I<sub>BQ</sub> = 56 mA, Pulse Width = 100 us, Duty Cycle = 10%

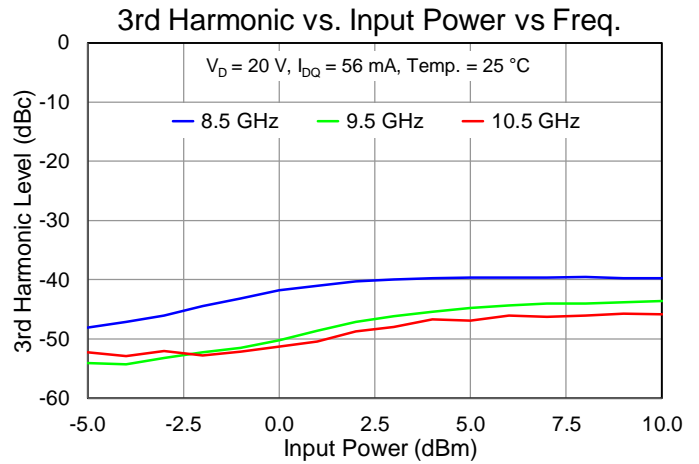
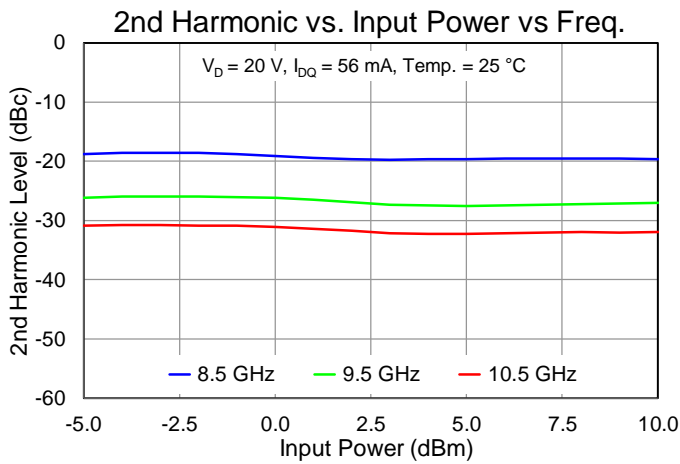
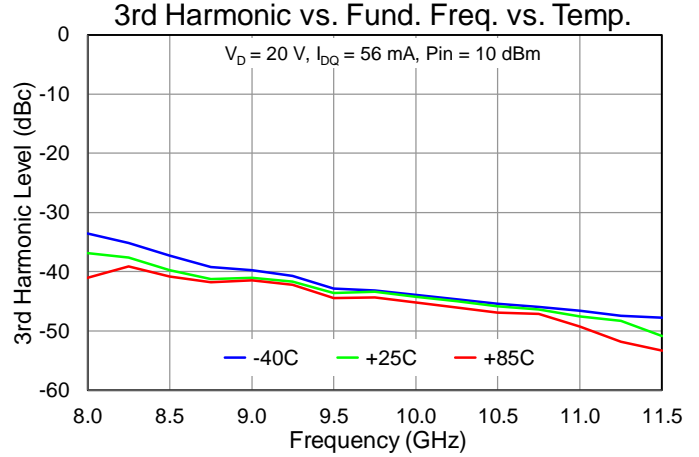
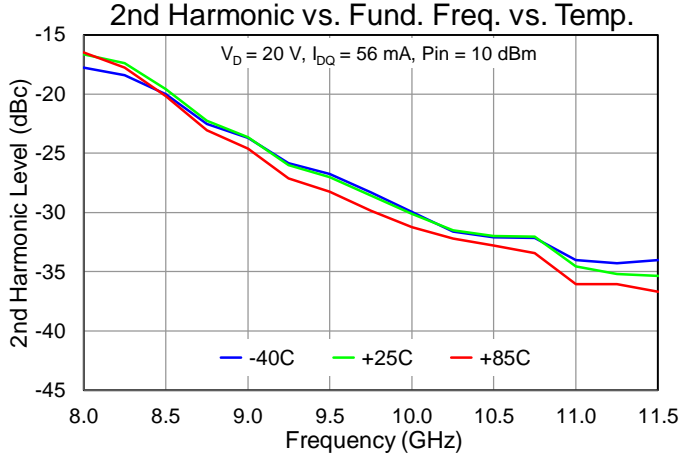

Performance Plots – Small Signal

Test conditions unless otherwise noted: T = +25 °C, V<sub>D</sub> = 20 V, I<sub>BQ</sub> = 56 mA, CW

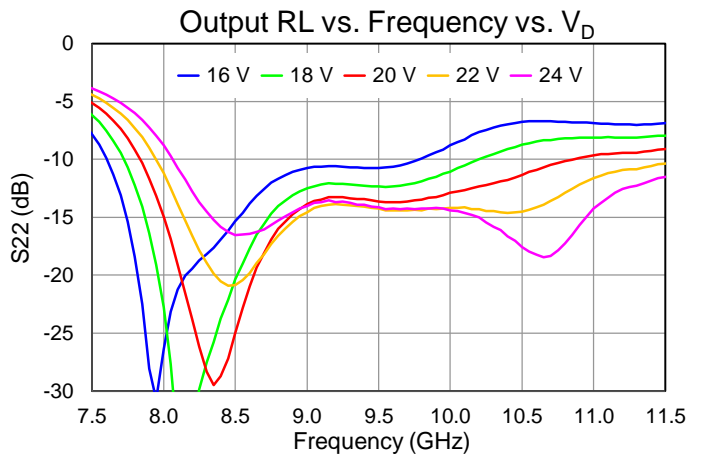
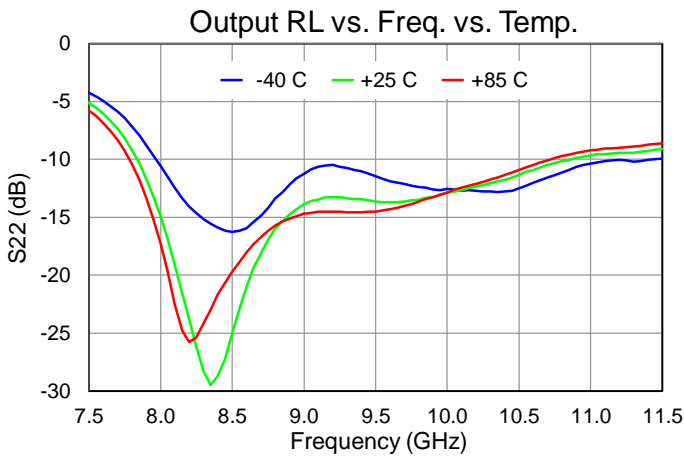
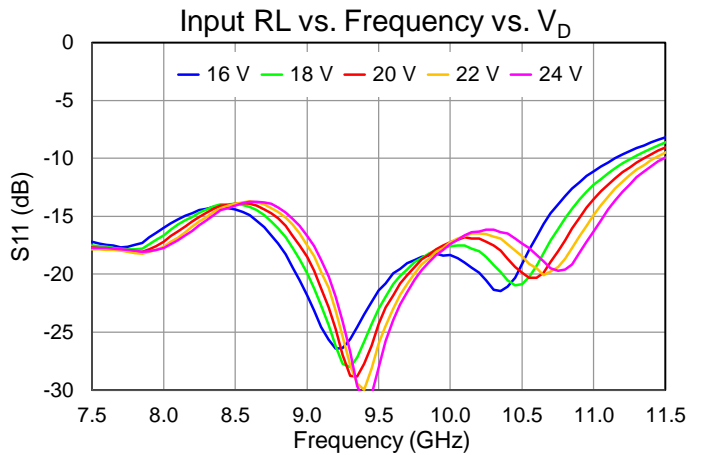
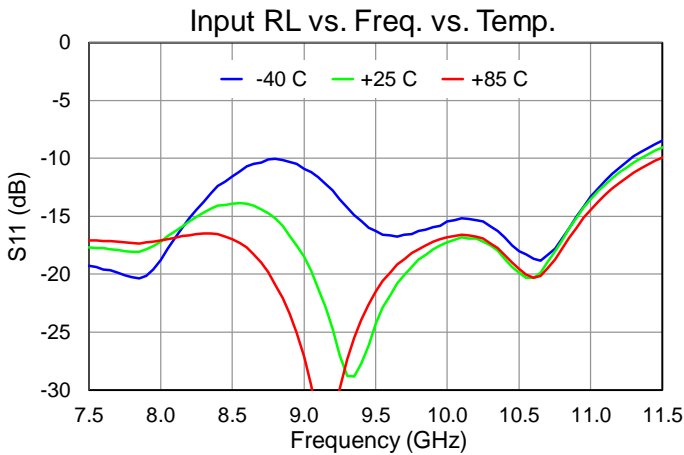
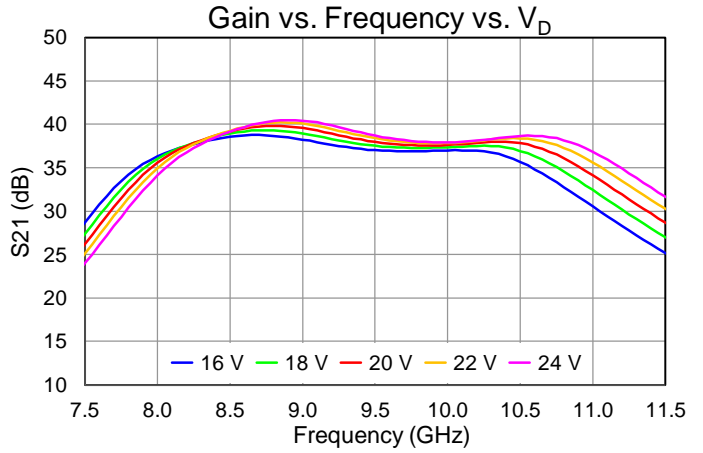
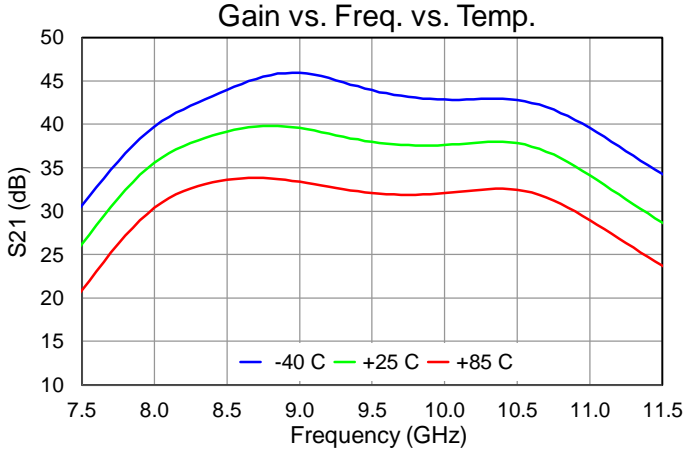

**Performance Plots – Small Signal**

Test conditions unless otherwise noted: T = +25 °C, V<sub>D</sub> = 20 V, I<sub>DQ</sub> = 56 mA, CW

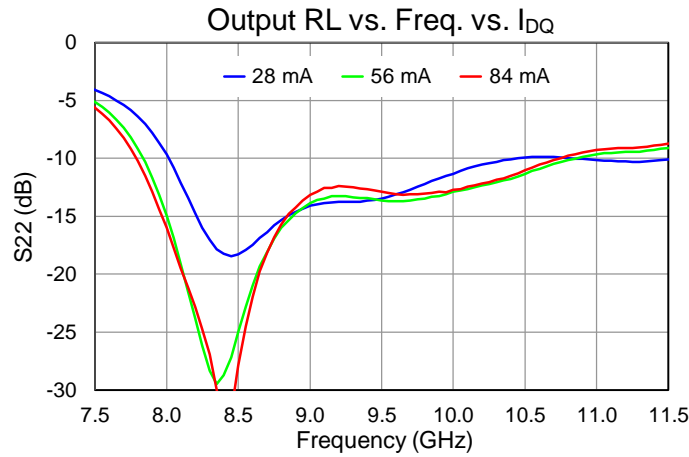
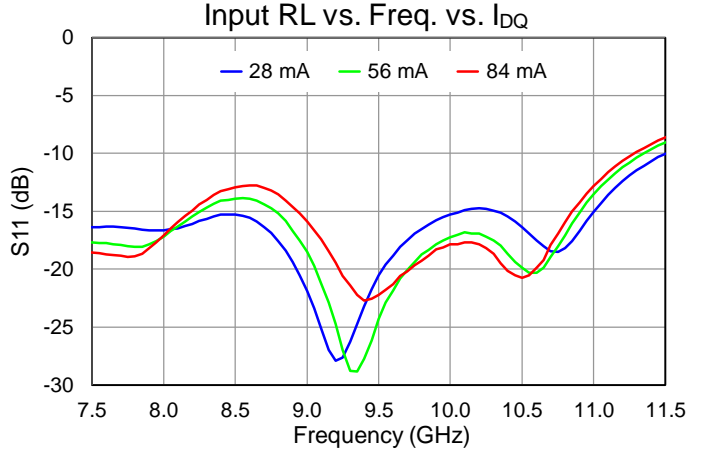
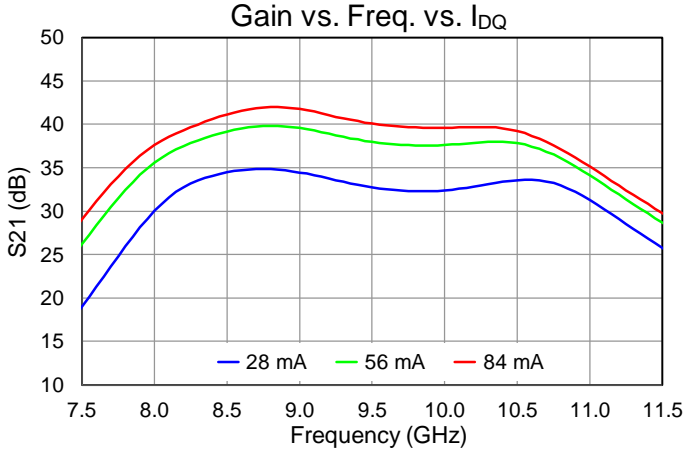

## Thermal and Reliability Information

Parameter	Test Conditions	Value	Units
Thermal Resistance ( $\theta_{JC}$ ) <sup>(1)</sup>	$T_{base} = +85\text{ }^{\circ}\text{C}$ , $V_D = 20\text{ V}$ , $I_{DQ} = 56\text{ mA}$ , $P_{DISS} = 1.12\text{ W}$ (quiescent, no RF)	11.30	$^{\circ}\text{C/W}$
Channel Temperature, $T_{CH}$ (Under RF) <sup>(2)</sup>		97.7	$^{\circ}\text{C}$
Thermal Resistance ( $\theta_{JC}$ ) <sup>(1)</sup>	$T_{base} = +85\text{ }^{\circ}\text{C}$ , $V_D = 20\text{ V}$ , $I_{DQ} = 56\text{ mA}$ , $I_{D\_Drive} = 260\text{ mA}$ , $P_{OUT} = 33.7\text{ dBm}$ , $P_{IN} = 10\text{ dBm}$ , Freq. = 11 GHz, $P_{DISS} = 2.85\text{ W}$ (Pulse: 100us/10%)	10.84	$^{\circ}\text{C/W}$
Channel Temperature, $T_{CH}$ (Under RF) <sup>(2)</sup>		115.9	$^{\circ}\text{C}$
Thermal Resistance ( $\theta_{JC}$ ) <sup>(1)</sup>	$T_{base} = +85\text{ }^{\circ}\text{C}$ , $V_D = 24\text{ V}$ , $I_{DQ} = 56\text{ mA}$ , $I_{D\_Drive} = 279\text{ mA}$ , $P_{OUT} = 34.5\text{ dBm}$ , $P_{IN} = 10\text{ dBm}$ , Freq. = 8.5 GHz, $P_{DISS} = 3.91\text{ W}$ (Pulse: 100us/10%)	11.38	$^{\circ}\text{C/W}$
Channel Temperature, $T_{CH}$ (Under RF) <sup>(2)</sup>		129.5	$^{\circ}\text{C}$

**Notes:**

- Thermal resistance is referenced to the back of the package.
- IR scan equivalent temperatures. Refer to the following document: [GaN Device Channel Temperature, Thermal Resistance, and Reliability Estimates](#)

## Power Dissipation and Maximum Gate Current

$P_{IN} = 10\text{ dBm}$ , Pulse Width = 100 us, Duty Cycle = 10%

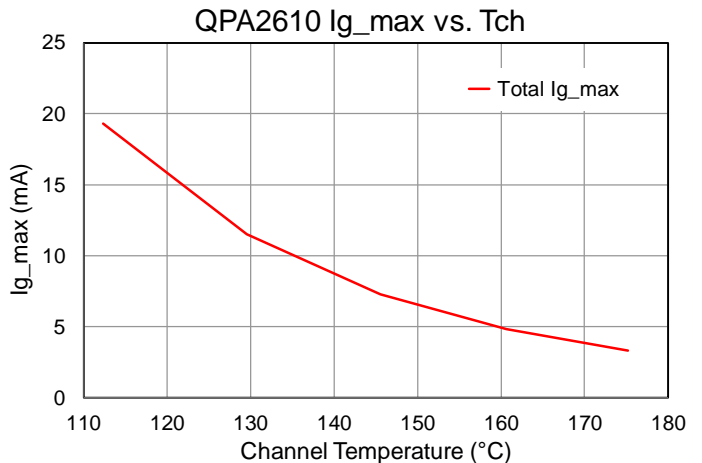
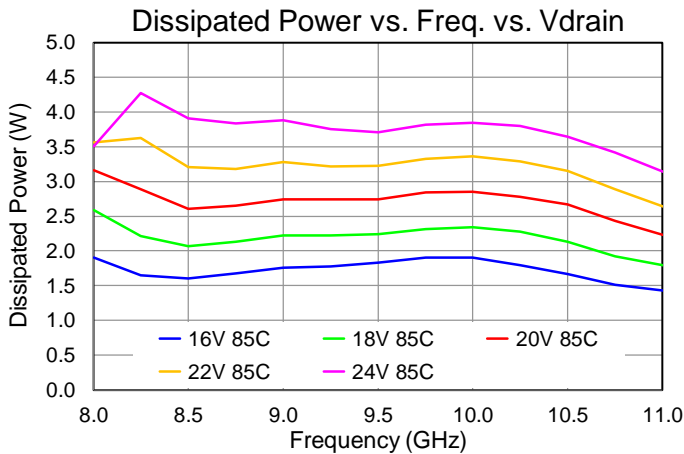



Application Information

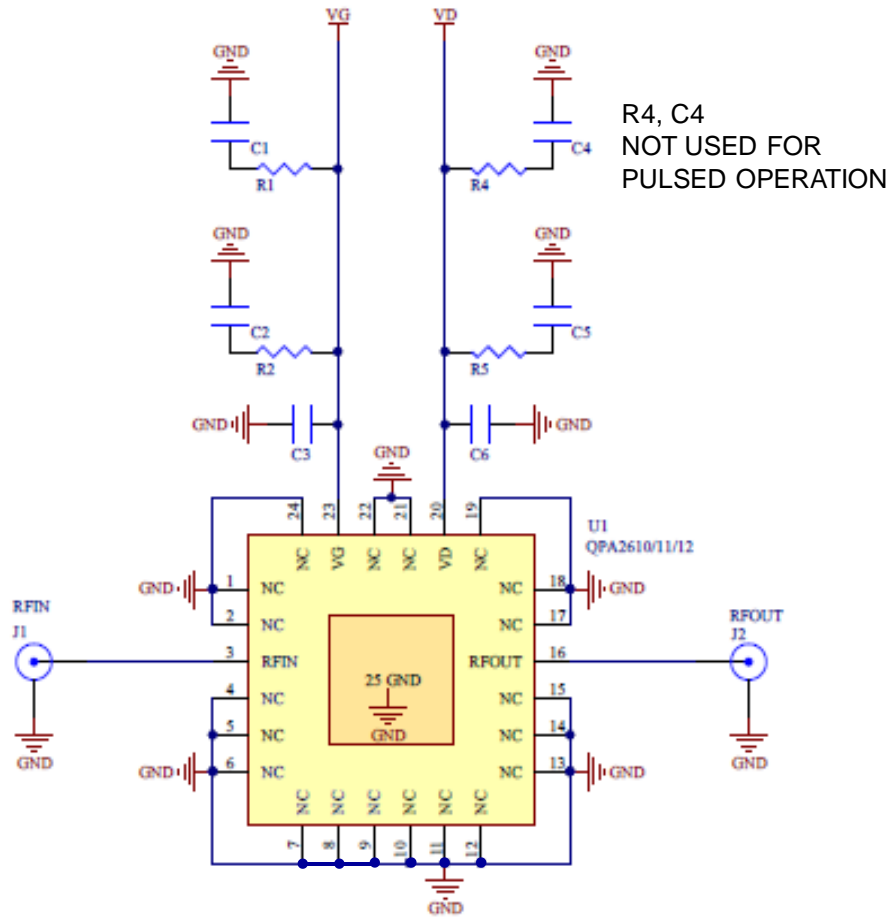

**Bias-up Procedure**

Set  $I_D$  limit to 750 mA,  $I_G$  limit to 10 mA

Apply -4 V to  $V_G$

Apply +20 V to  $V_D$ ; ensure  $I_{DQ}$  is approx. 0 mA

Adjust  $V_G$  until  $I_{DQ} = 56$  mA

Turn on RF supply

**Bias-down Procedure**

Turn off RF signal

Reduce  $V_G$  to -4 V; ensure  $I_{DQ}$  is approx. 0 mA

Set  $V_D$  to 0 V

Turn off  $V_D$  supply

Turn off  $V_G$  supply

## Pin Layout

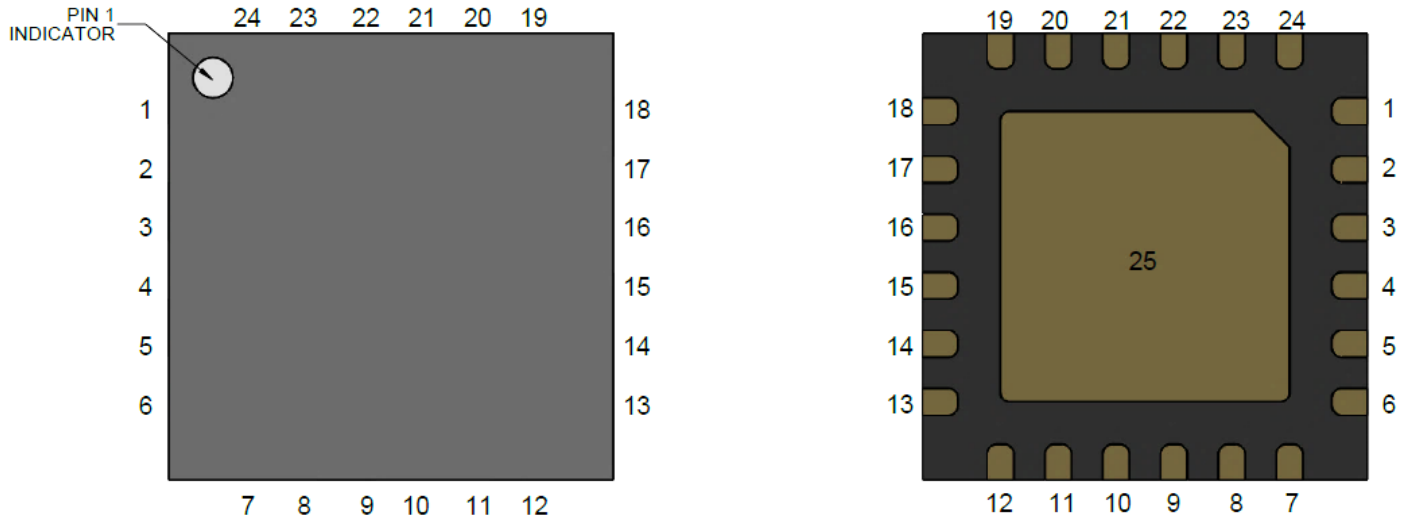

## Pin Description

Pin Number	Symbol	Description
1, 2, 4-15, 17-19, 21, 22, 24	NC	No connection inside of package. Connection to PCB ground recommended
3	RF IN	RF input. 50 $\Omega$ , DC blocked
16	RF OUT	RF output. 50 $\Omega$ , DC blocked
20	VD	Drain voltage. Bypass network required; refer to page 19
23	VG	Gate voltage. Bypass network required; refer to page 19
25	GND	Center paddle ground

Evaluation Board

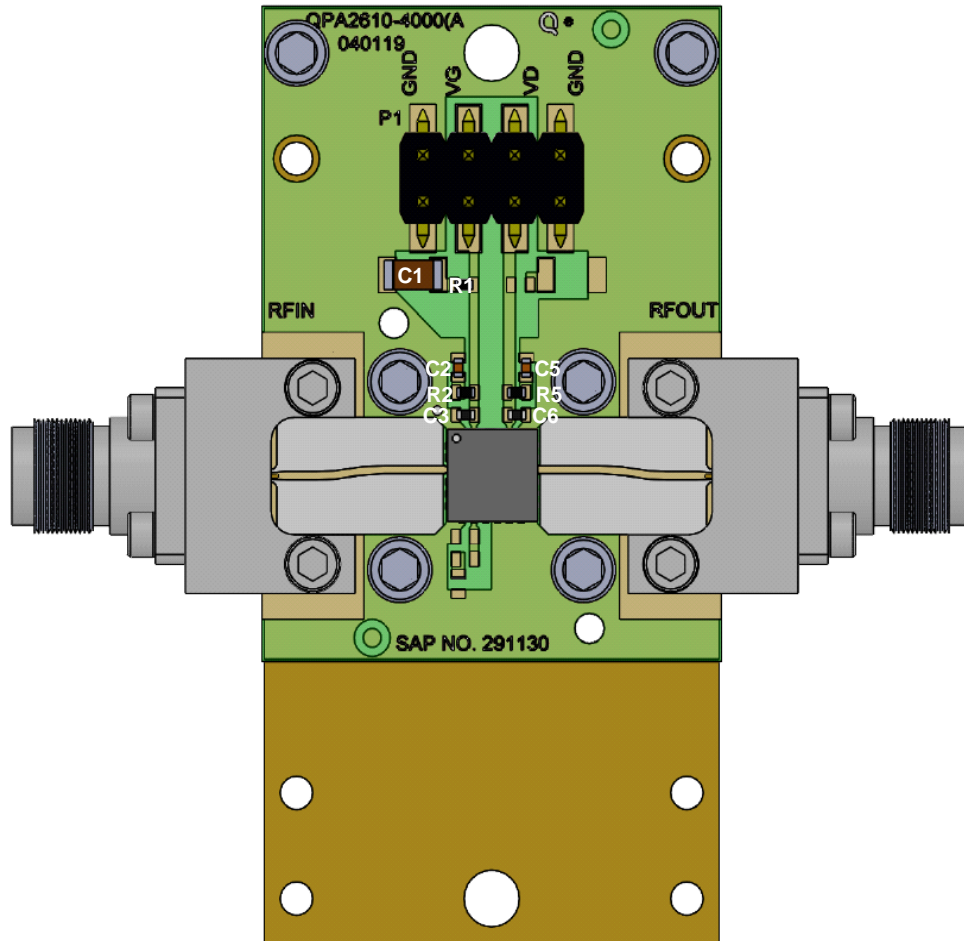

Bill of Materials

Ref. Des.	Value	Description	Manuf.	Part Number
C1	10 uF	CAP, 10uF, 20%, 50V, 20%, X5R, 1206	various	
C3,C6	1000 pF	CAP, 1000pF, 10%, 100V, X7R, 0402	various	
C2,C5	0.1 uF	CAP, 0.1uF, 10%, 50V, X7R, 0402	various	
R2,R5	10 Ω	RES, 10 OHM, 5%, 0.1W, 0402	various	
R1	0 Ω	RES, 0 OHM, JMPR, 0402	various	
J1, J2		2.92mm Female End Launch Connector	Southwest Microwave	1092-01A-5

Mechanical Information

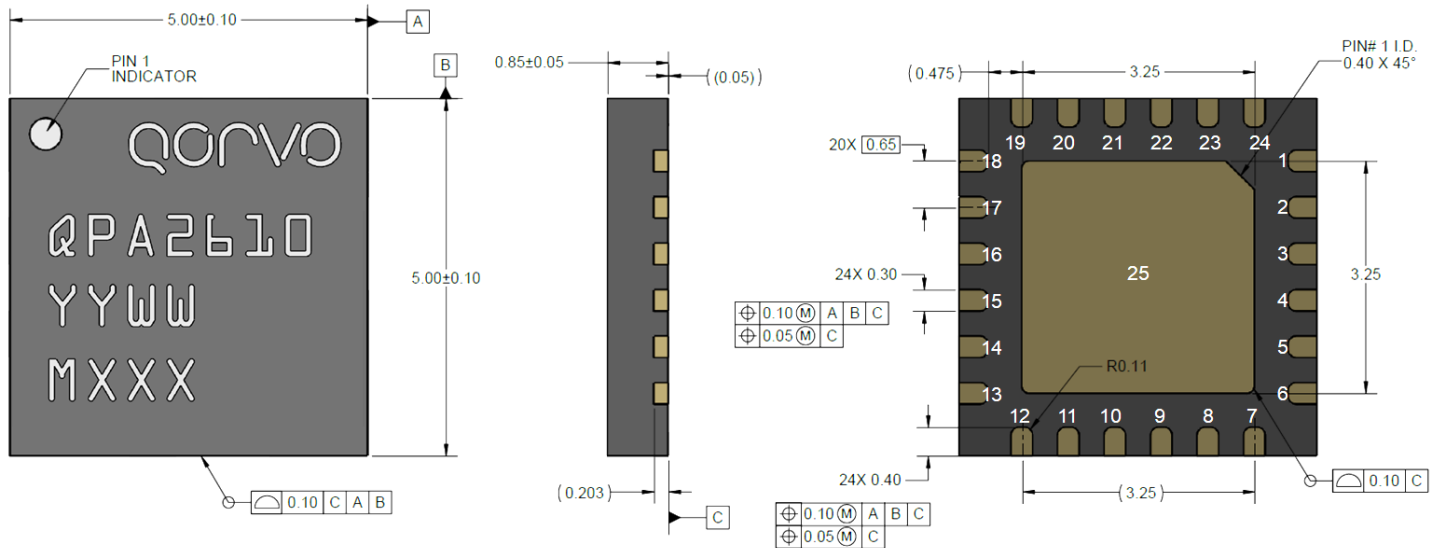

NOTES:

Package base and leads are Ni-Au plated

Part Markings:

Part Number: QPA2610

Part Assembly Year: YY

Part Assembly Week: WW

Lot Number: MXXX

Dimensions are in millimeters

Assembly Notes

Compatible with lead-free soldering processes with 260°C peak reflow temperature.

Contact plating: Ni-Au.

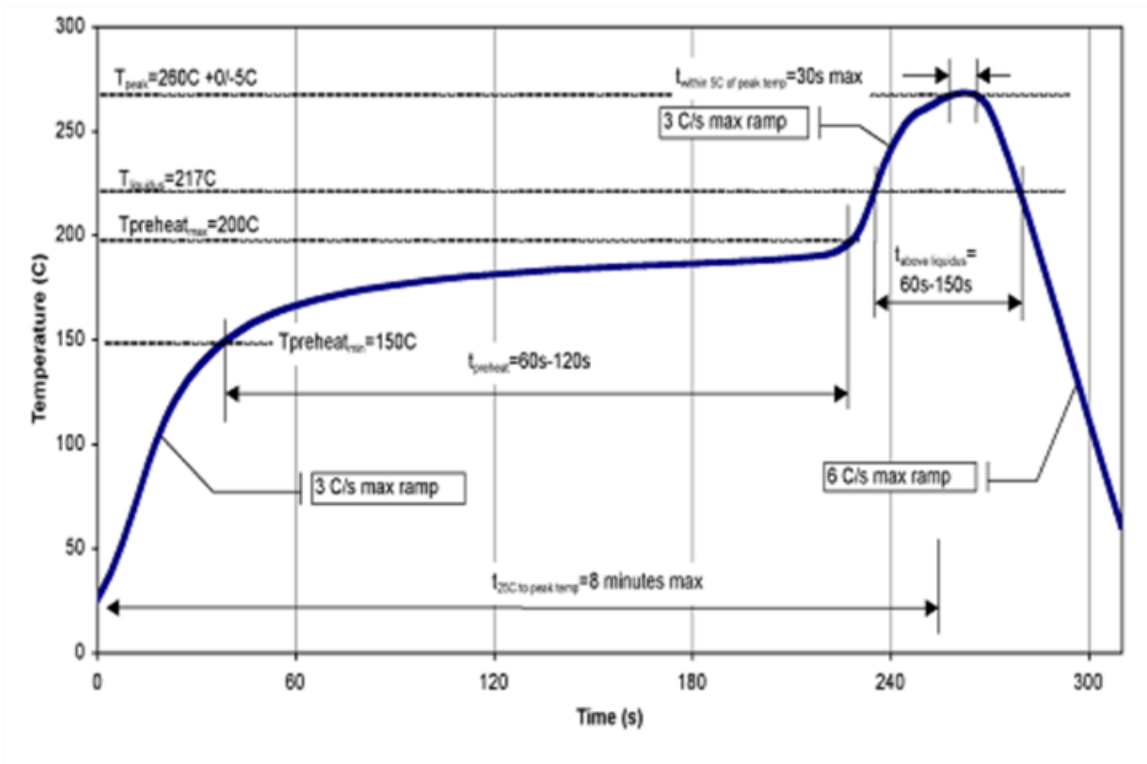

Recommended Soldering Temperature Profile

Tape and Reel Information – Carrier and Cover Tape Dimensions

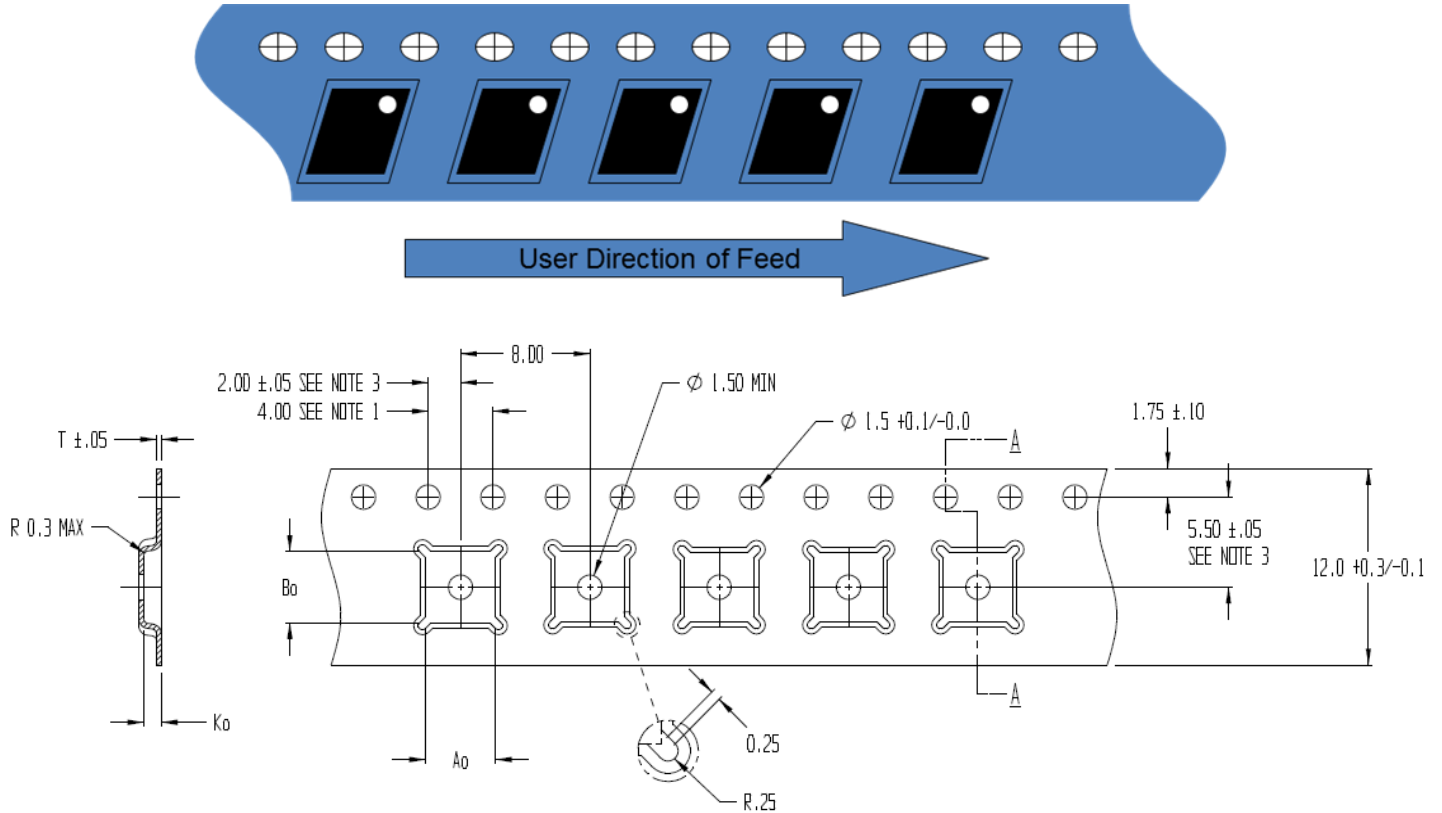

Feature	Measure	Symbol	Size (in)	Size (mm)
Cavity	Length	A0	0.189	4.80
	Width	B0	0.209	5.30
	Depth	K0	0.051	1.30
	Pitch	P1	0.315	8.00
Centerline Distance	Cavity to Perforation - Length Direction	P2	0.079	2.00
	Cavity to Perforation - Width Direction	F	0.217	5.50
Cover Tape	Width	C	0.362	9.20
Carrier Tape	Width	W	0.472	12.00

**Tape and Reel Information – Reel Dimensions**

Standard T/R size = 500 pieces on a 7" reel.

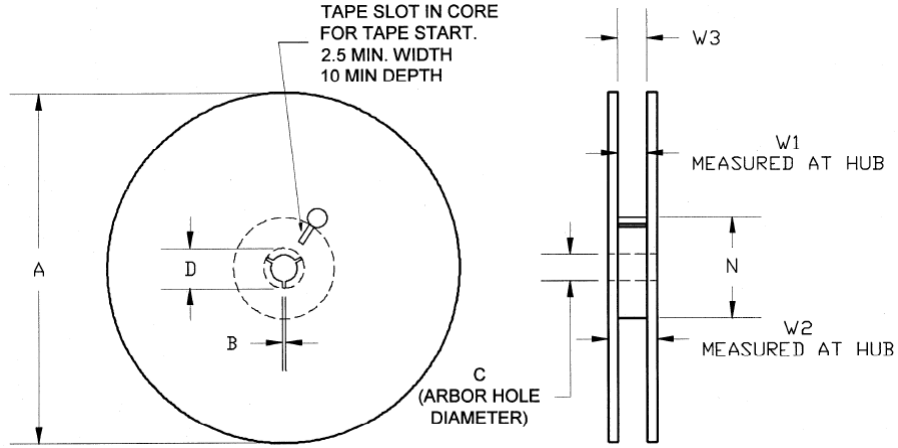

Feature	Measure	Symbol	Size (in)	Size (mm)
Flange	Diameter	A	6.969	177.0
	Thickness	W2	0.717	18.2
	Space Between Flange	W1	0.504	12.8
Hub	Outer Diameter	N	2.283	58.0
	Arbor Hole Diameter	C	0.512	13.0
	Key Slit Width	B	0.079	2.0
	Key Slit Diameter	D	0.787	20.0

**Tape and Reel Information – Tape Length and Label Placement**

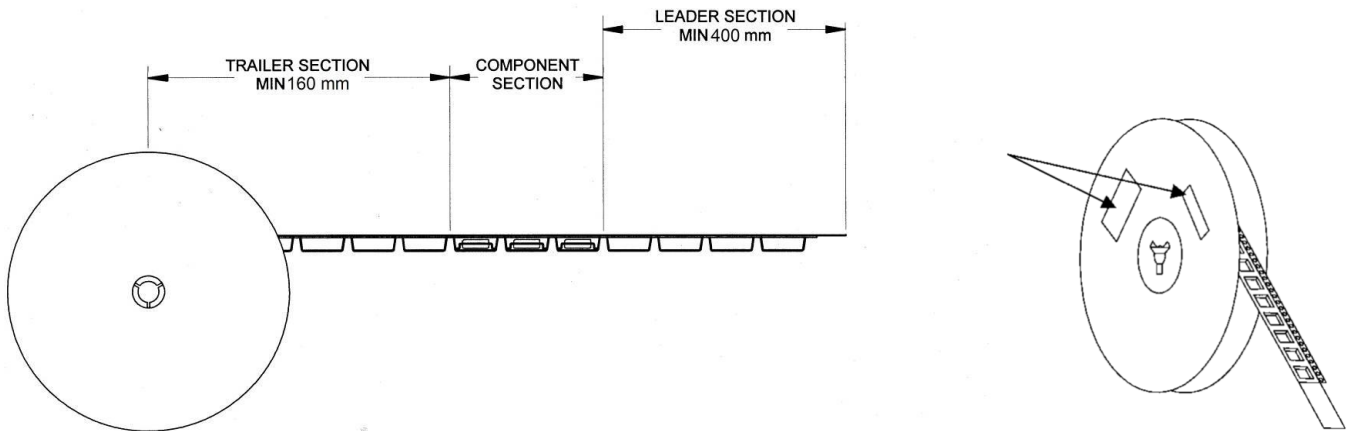

- Notes:
1. Empty part cavities at the trailing and leading ends are sealed with cover tape. See EIA 481-1-A.
  2. Labels are placed on the flange opposite the sprockets in the carrier tape.

## Handling Precautions

Parameter	Rating	Standard
ESD – Human Body Model (HBM)	1A	ESDA / JEDEC JS-001-2014
ESD – Charged Device Model (CDM)	C3	ESDA / JEDEC JS-002-2017
MSL – Moisture Sensitivity Level	3	IPC/JEDEC J-STD-020



Caution!  
ESD-Sensitive Device

## RoHS Compliance

This part is compliant with 2011/65/EU RoHS directive (Restrictions on the Use of Certain Hazardous Substances in Electrical and Electronic Equipment) as amended by Directive 2015/863/EU.

This product also has the following attributes:

- Lead Free
- Halogen Free (Chlorine, Bromine)
- Antimony Free
- TBBP-A (C<sub>15</sub>H<sub>12</sub>Br<sub>4</sub>O<sub>2</sub>) Free
- SVHC Free

## Contact Information

For the latest specifications, additional product information, worldwide sales and distribution locations:

**Web:** [www.qorvo.com](http://www.qorvo.com)

**Tel:** 1-844-890-8163

**Email:** [customer.support@qorvo.com](mailto:customer.support@qorvo.com)

## Important Notice

The information contained herein is believed to be reliable; however, Qorvo makes no warranties regarding the information contained herein and assumes no responsibility or liability whatsoever for the use of the information contained herein. All information contained herein is subject to change without notice. Customers should obtain and verify the latest relevant information before placing orders for Qorvo products. The information contained herein or any use of such information does not grant, explicitly or implicitly, to any party any patent rights, licenses, or any other intellectual property rights, whether with regard to such information itself or anything described by such information. **THIS INFORMATION DOES NOT CONSTITUTE A WARRANTY WITH RESPECT TO THE PRODUCTS DESCRIBED HEREIN, AND QORVO HEREBY DISCLAIMS ANY AND ALL WARRANTIES WITH RESPECT TO SUCH PRODUCTS WHETHER EXPRESS OR IMPLIED BY LAW, COURSE OF DEALING, COURSE OF PERFORMANCE, USAGE OF TRADE OR OTHERWISE, INCLUDING THE IMPLIED WARRANTIES OF MERCHANTABILITY AND FITNESS FOR A PARTICULAR PURPOSE.**

Without limiting the generality of the foregoing, Qorvo products are not warranted or authorized for use as critical components in medical, life-saving, or life-sustaining applications, or other applications where a failure would reasonably be expected to cause severe personal injury or death.

© 2020 Qorvo US, Inc. All rights reserved. This document is subject to copyright laws in various jurisdictions worldwide and may not be reproduced or distributed, in whole or in part, without the express written consent of Qorvo US, Inc.



# Mouser Electronics

Authorized Distributor

Click to View Pricing, Inventory, Delivery & Lifecycle Information:

[Qorvo:](#)

[QPA2610TR7](#) [QPA2610](#) [QPA2610EVB](#)