

Product Description

Qorvo’s TGA3042-SM is a packaged high power MMIC amplifier fabricated on Qorvo’s production 0.15um GaN on SiC process (QGaN15). The TGA3042-SM operates from 7 – 10.5 GHz and typically provides 4.5 W saturated output power with power-added efficiency of 38.5% and large-signal gain of 23.5 dB. This combination of wideband performance provides the flexibility designers are looking for to improve system performance while reducing size and cost.

The TGA3042-SM is matched to 50Ω with integrated DC blocking capacitors on both RF I/O ports simplifying system integration. The wideband performance makes it ideally suited in support of multiple radar and communication bands.

Lead-free and RoHS compliant.

Evaluation boards are available upon request.

Functional Block Diagram

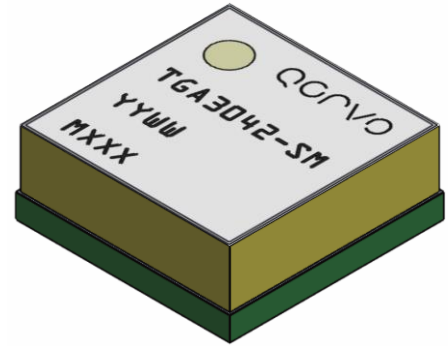
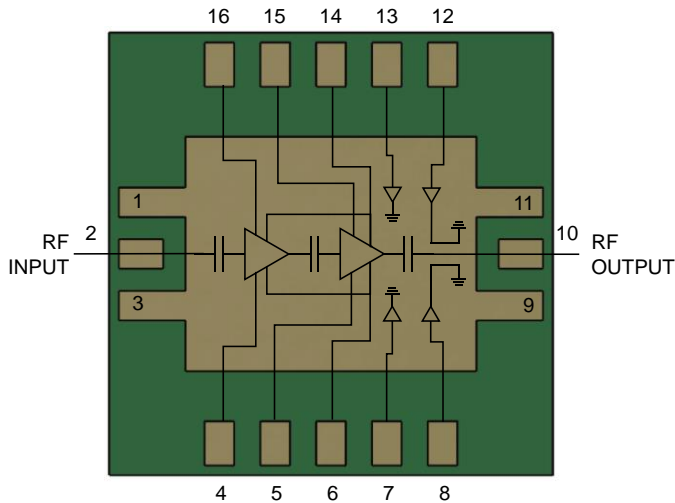

Product Features

- Frequency Range: 7 – 10.5 GHz
- P_{OUT}: 36.5 dBm at P_{IN} = 13 dBm
- PAE: 38.5 % at P_{IN} = 13 dBm
- Large Signal Gain: 23.5 dB at P_{IN} = 13 dBm
- Small Signal Gain: 32 dB
- Bias: V_D = 20 V, I_{DQ} = 200 mA
- Package Dimensions: 4.50 x 4.50 x 1.74 mm

Performance is typical across frequency. Please reference electrical specification table and data plots for more details.

Applications

- Radar
- Communications

Ordering Information

Part No.	Description
TGA3042-SM	7 – 10.5 GHz 4.5 W GaN Power Amplifier
TGA3042-SMPCB4B01	Evaluation Board



Absolute Maximum Ratings

Parameter	Value / Range
Drain Voltage (V_D)	29.5 V
Gate Voltage Range (V_G)	-8 to 0 V
Drain Current (I_D)	720 mA
Gate Current (I_G)	See chart pg. 13
Power Dissipation (P_{DISS}), 85°C	15.4 W
Input Power (P_{IN}), CW, 50Ω, $V_D=20$ V, $I_{DQ}=200$ mA, 85 °C	23 dBm
Input Power (P_{IN}), CW, VSWR 3:1, $V_D=20$ V, $I_{DQ}=200$ mA 85 °C	23 dBm
Mounting Temperature (30 Seconds)	260 °C
Storage Temperature	-55 to 150 °C

Operation of this device outside the parameter ranges given above may cause permanent damage. These are stress ratings only, and functional operation of the device at these conditions is not implied.

Recommended Operating Conditions

Parameter	Value / Range
Drain Voltage (V_D)	20 V
Drain Current (I_{DQ})	200 mA
Gate Voltage Range (V_G)	-2.8 to -2.0 V

Electrical specifications are measured at specified test conditions. Specifications are not guaranteed over all recommended operating conditions.

Electrical Specifications

Parameter		Min	Typ	Max	Units
Operational Frequency Range		7		10.5	GHz
Output Power ($P_{in} = 13$ dBm)	7.0 GHz	35.0	36.3		dBm
	9.0 GHz	35.0	36.5		dBm
	10.5 GHz	34.5	35.9		dBm
Power Added Efficiency ($P_{in} = 13$ dBm)	7.0 GHz	30.0	41.1		%
	9.0 GHz	30.0	38.9		%
	10.5 GHz	28.0	37.8		%
3 rd Order Intermodulation Level ($P_{OUT}/Tone = 26$ dBm)	7.0 GHz		-23.2		dBc
	9.0 GHz		-24.7		dBc
	10.5 GHz		-23.4		dBc
Small Signal Gain	7.0 GHz		33.3		dB
	9.0 GHz		32.9		dB
	10.5 GHz		30.6		dB
Input Return Loss	7.0 GHz		12		dB
	9.0 GHz		15		dB
	10.5 GHz		18		dB
Output Return Loss	7.0 GHz		9		dB
	9.0 GHz		13		dB
	10.5 GHz		10		dB
Output Power Temperature Coefficient (25 – 85 °C)			-0.006		dB/°C
Sm. Signal Gain Temperature Coefficient			-0.059		dB/°C

Test conditions unless otherwise noted: 25 °C, $V_D = 20$, $I_{DQ} = 200$ mA

Performance Plots – Large Signal (CW)

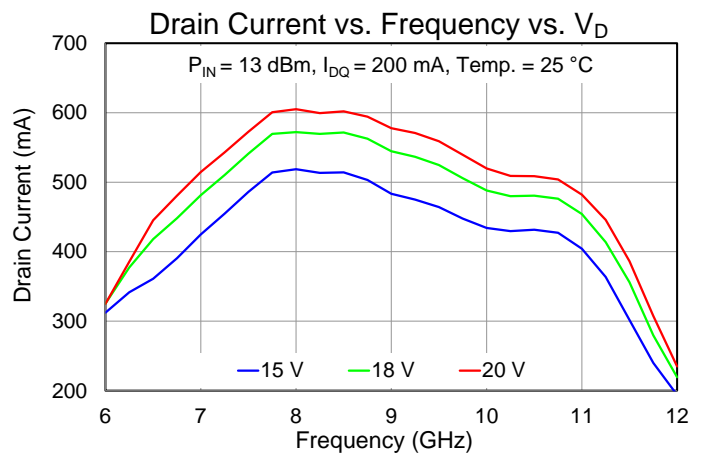
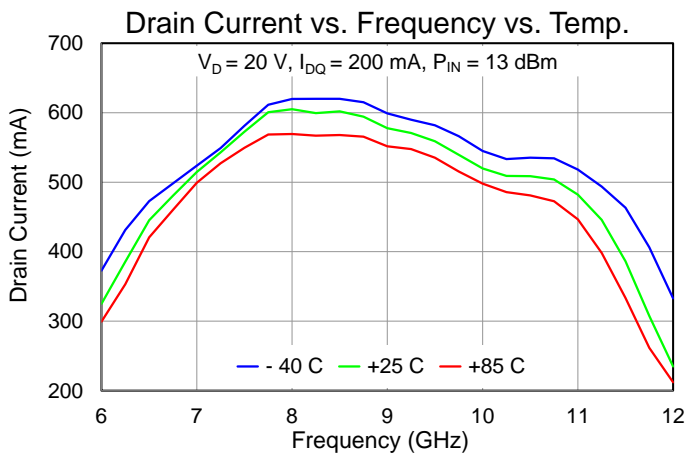
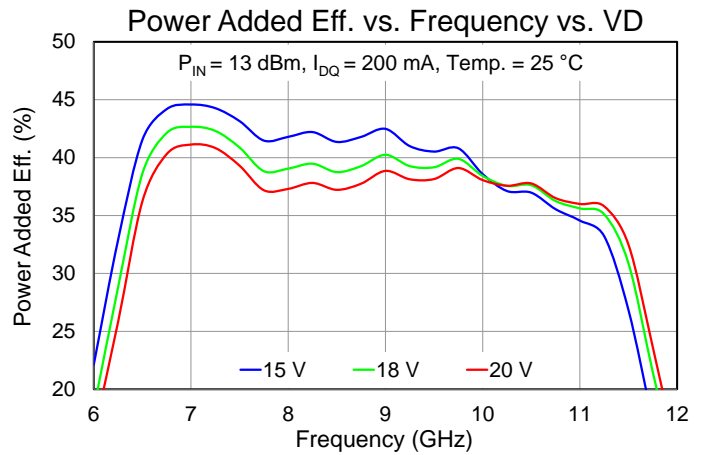
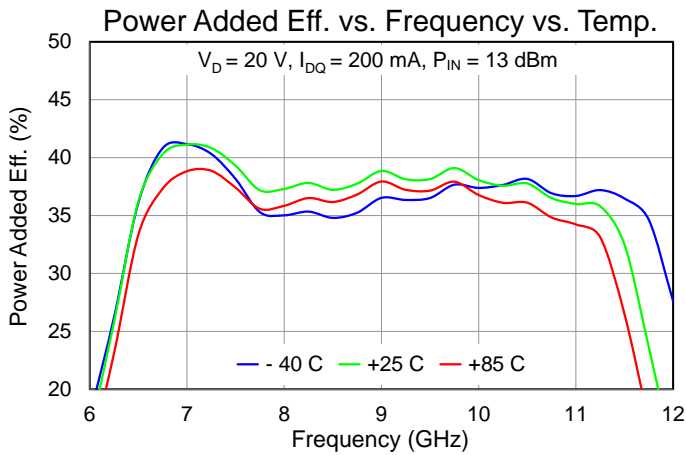
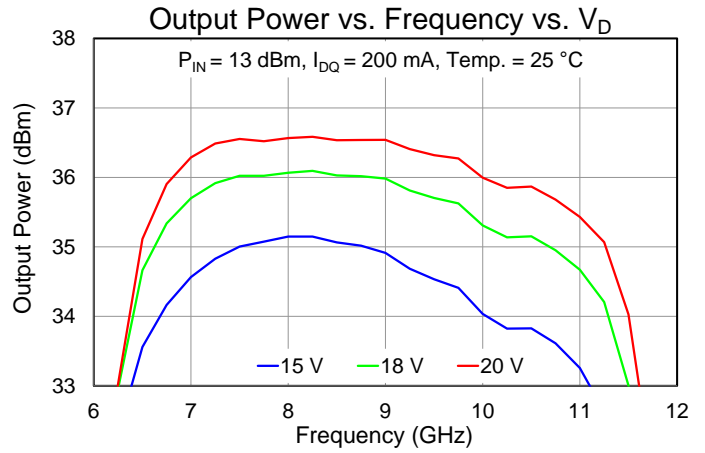
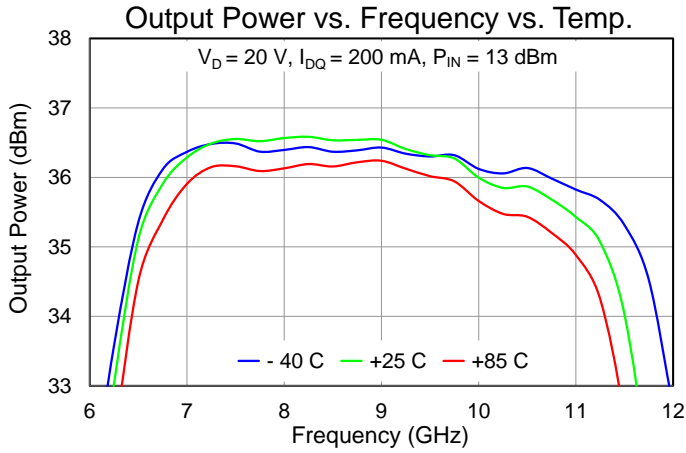

Performance Plots – Large Signal (CW)

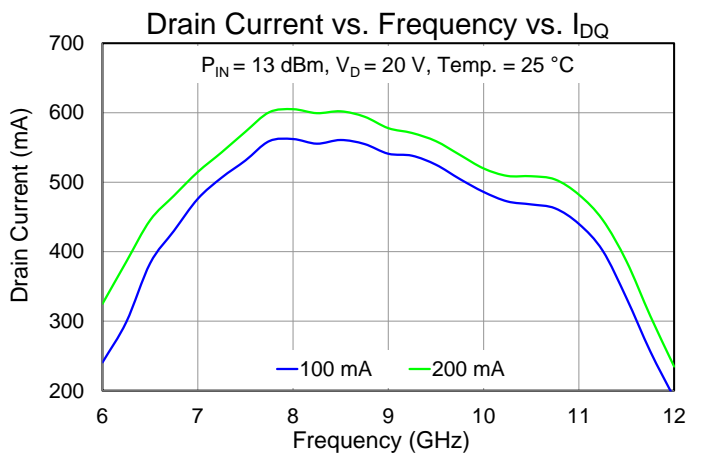
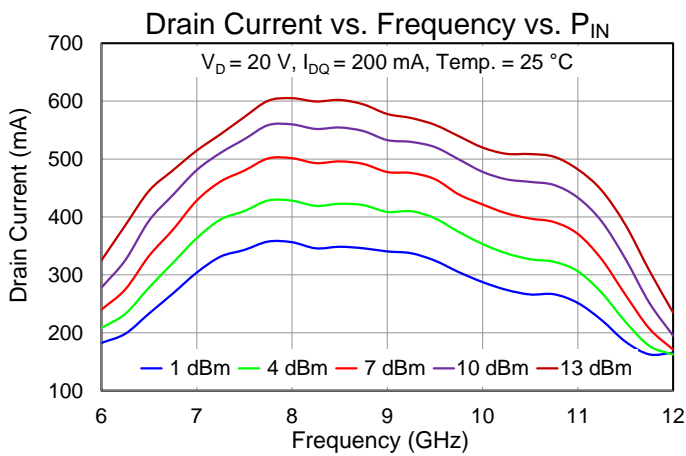
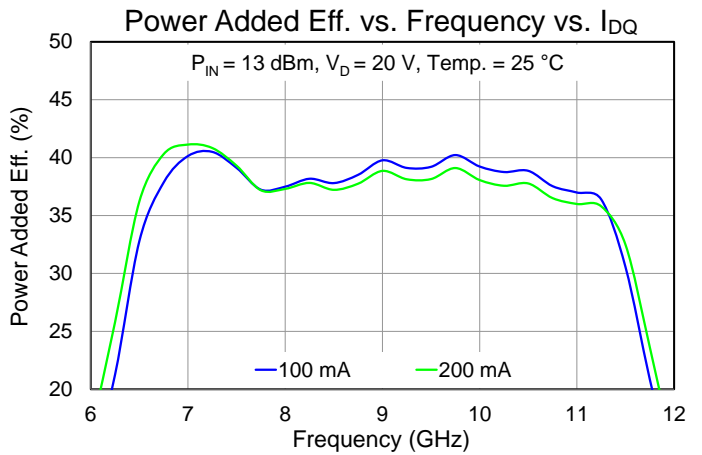
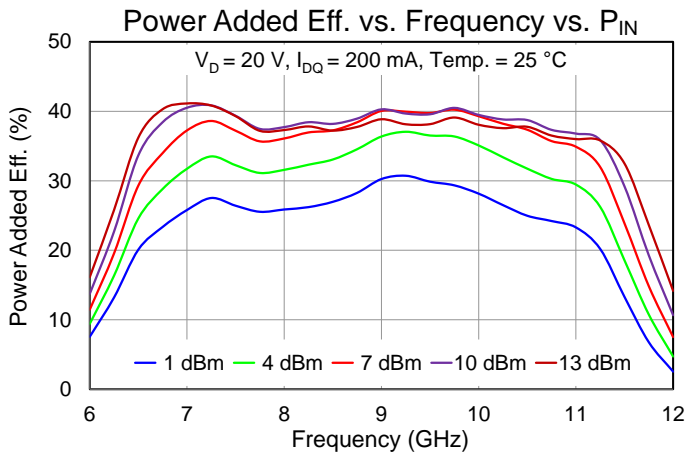
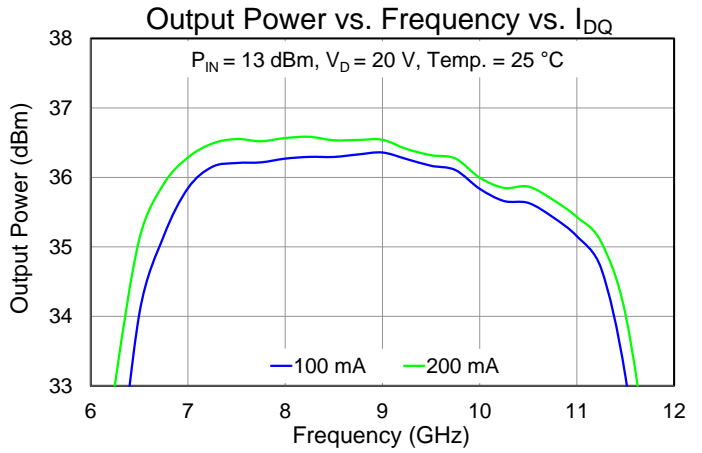
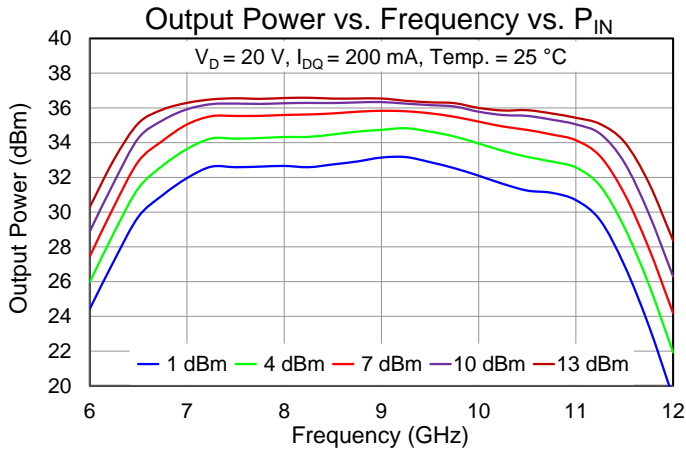

Performance Plots – Large Signal (CW)

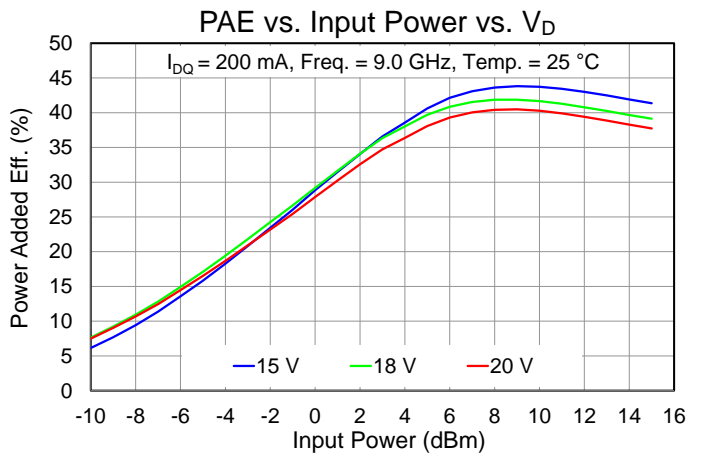
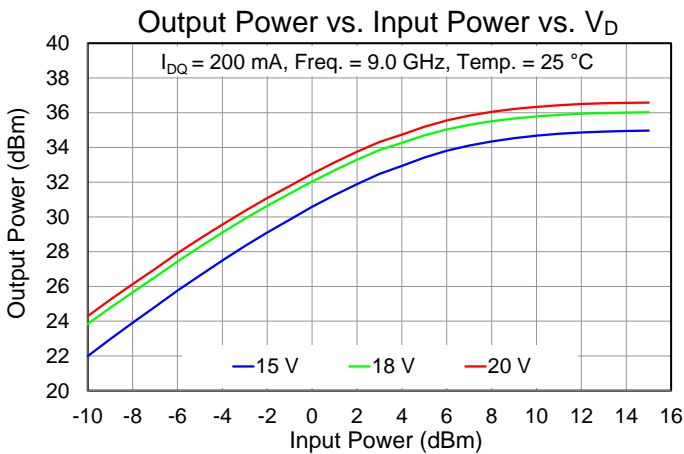
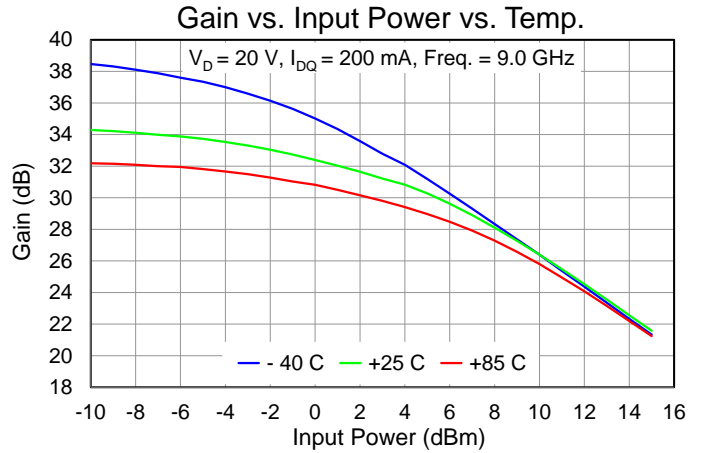
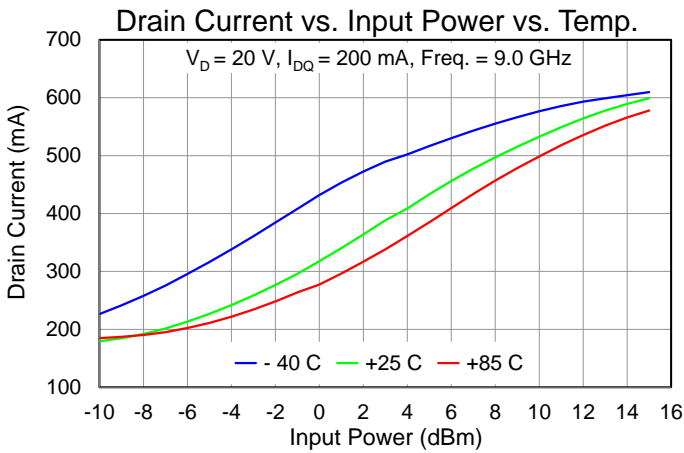
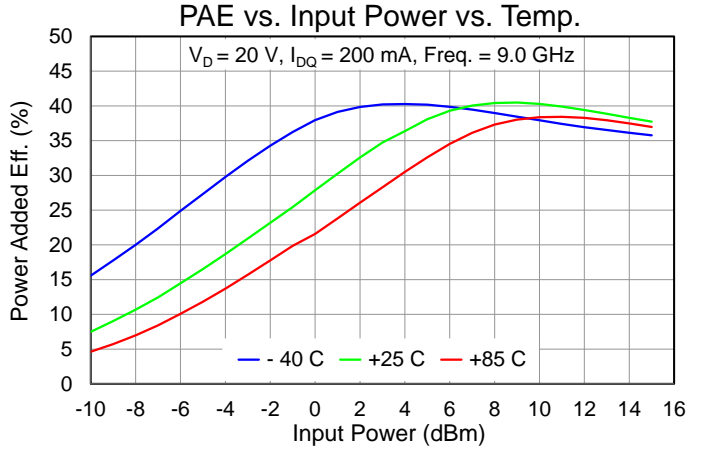
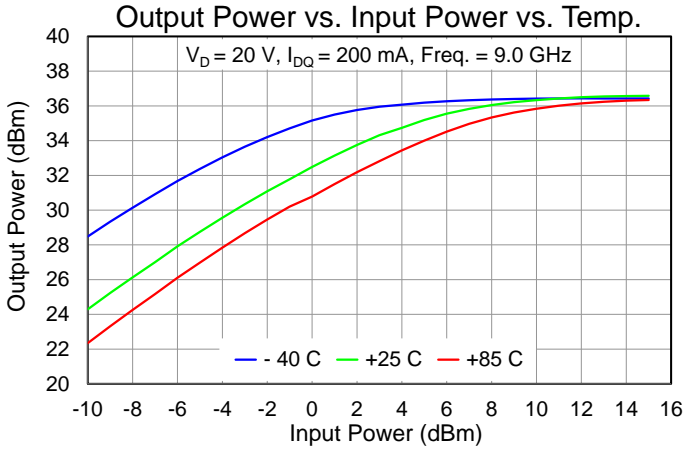

Performance Plots – Large Signal (CW)

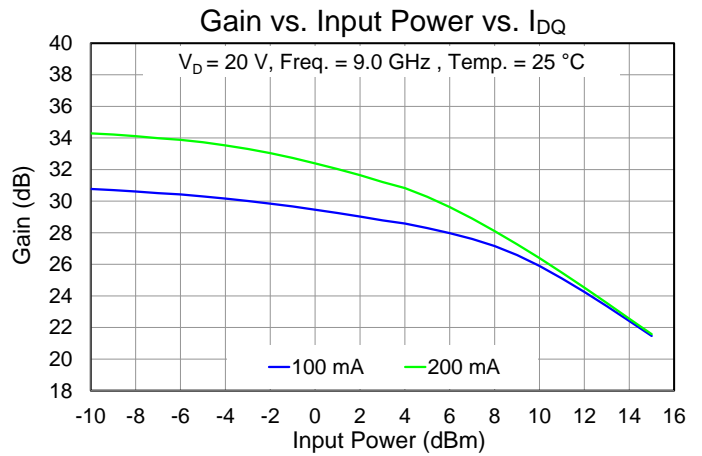
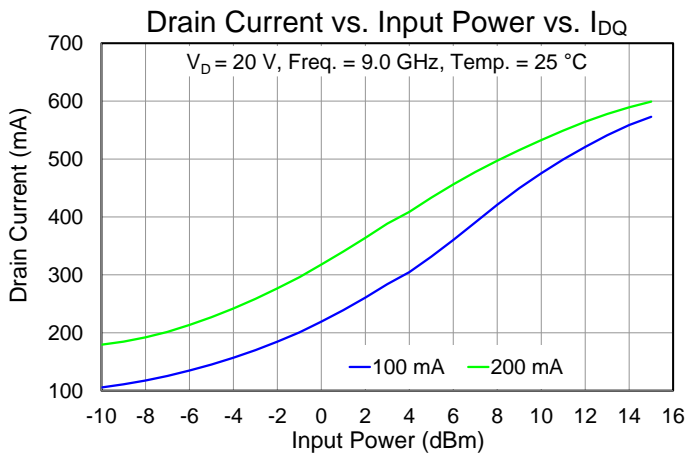
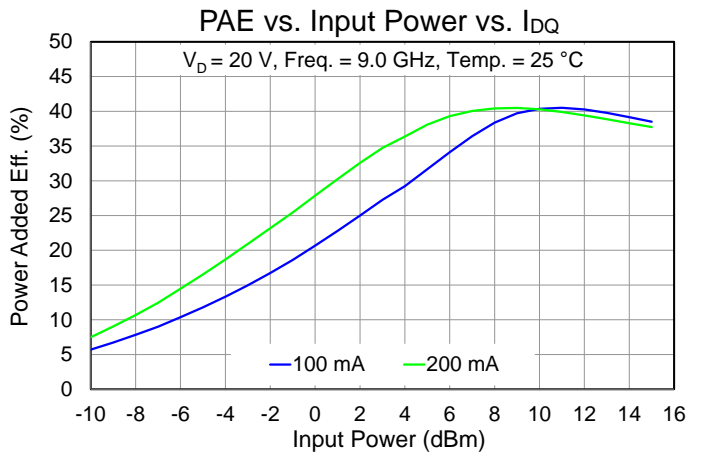
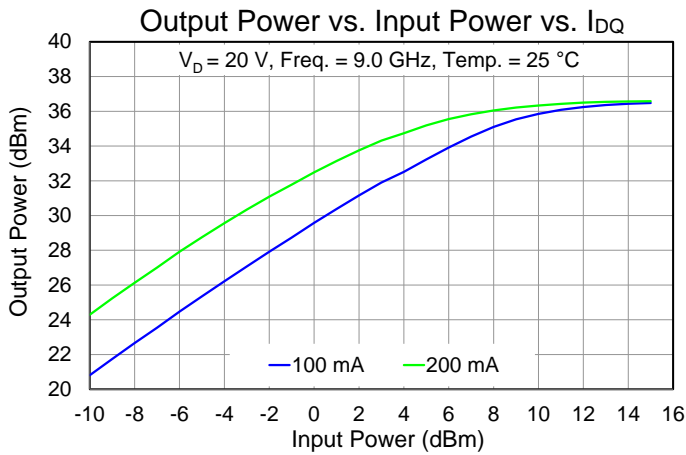
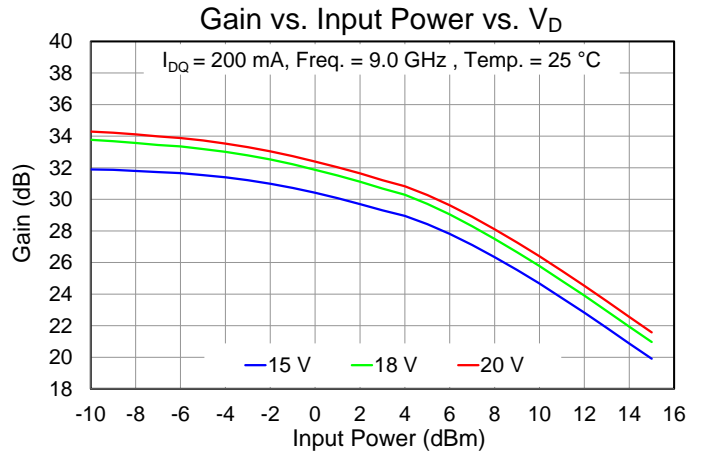
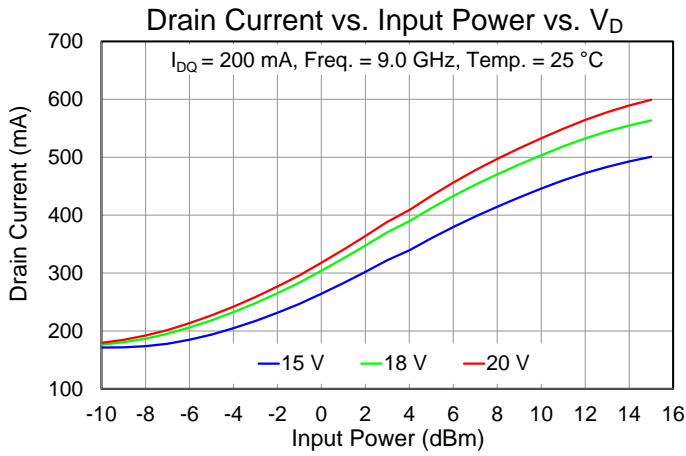

Performance Plots – Linearity

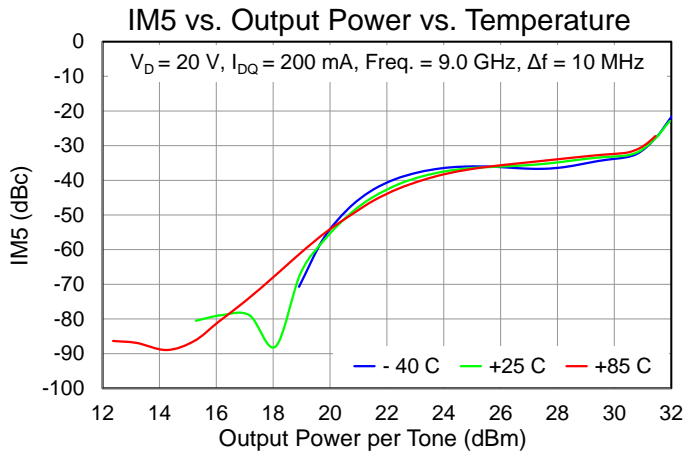
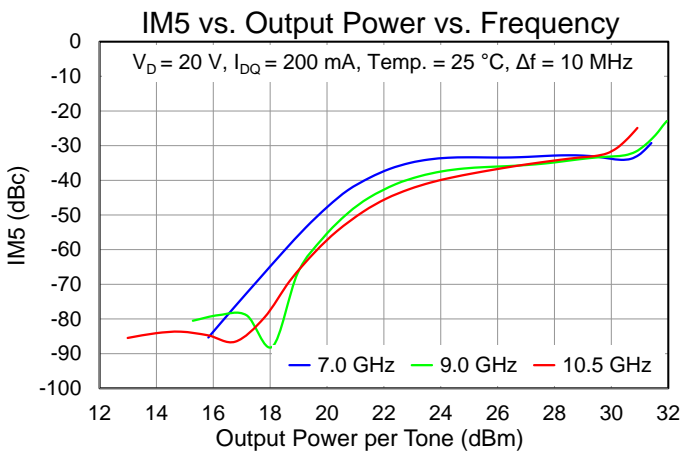
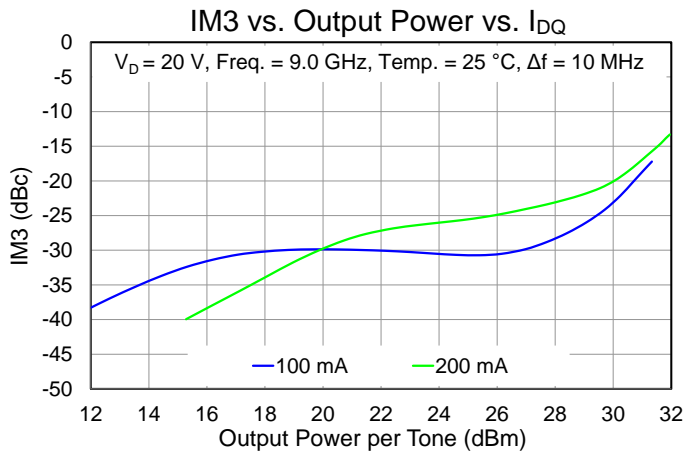
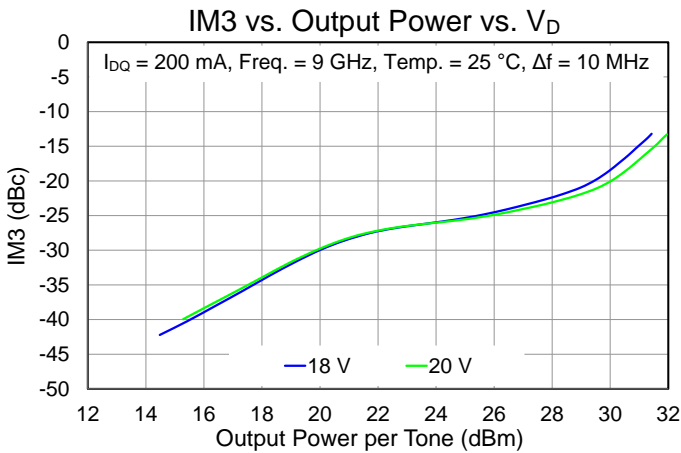
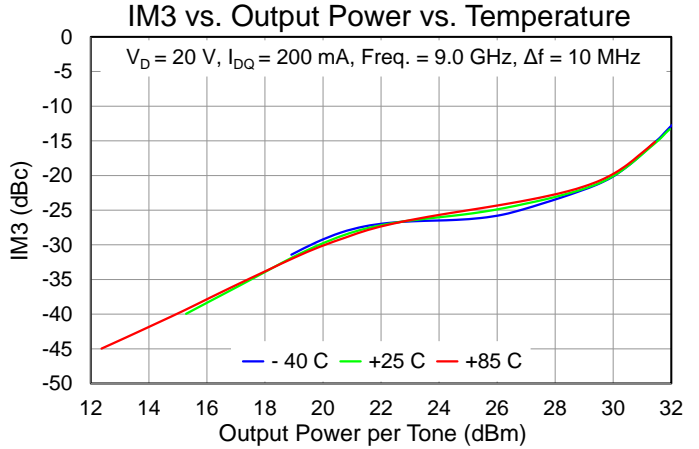
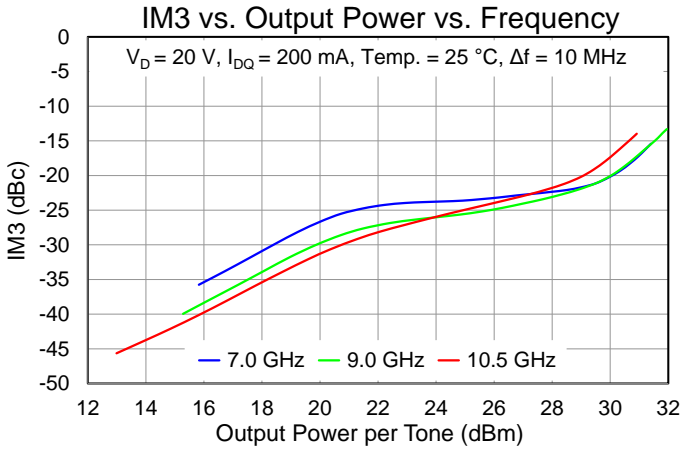

Performance Plots – Linearity, Harmonics

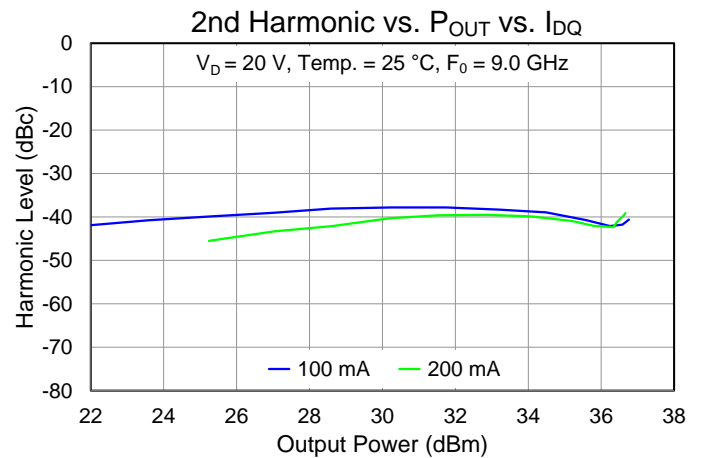
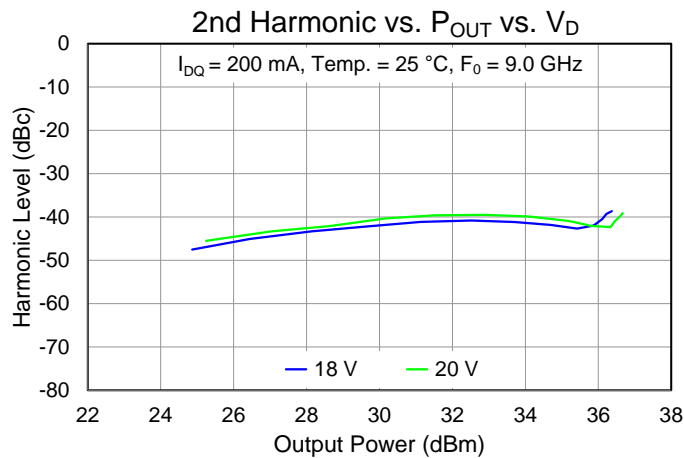
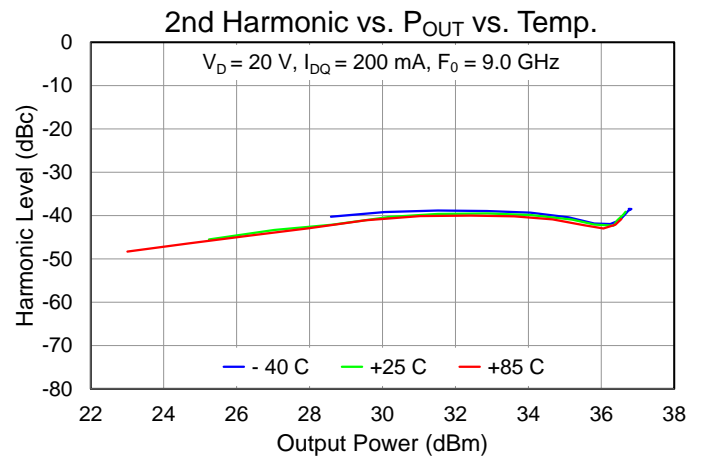
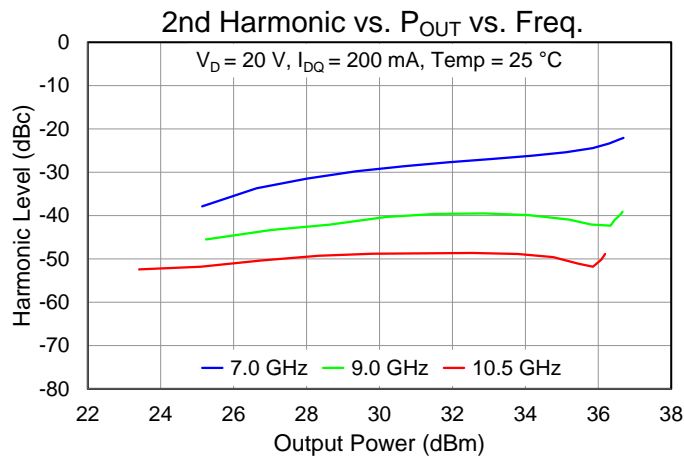
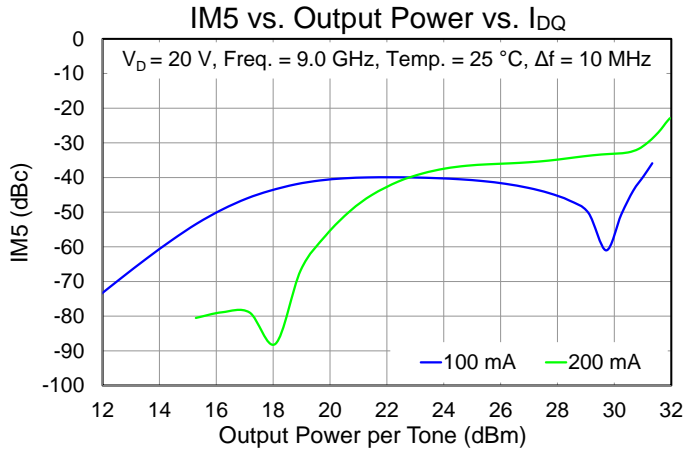
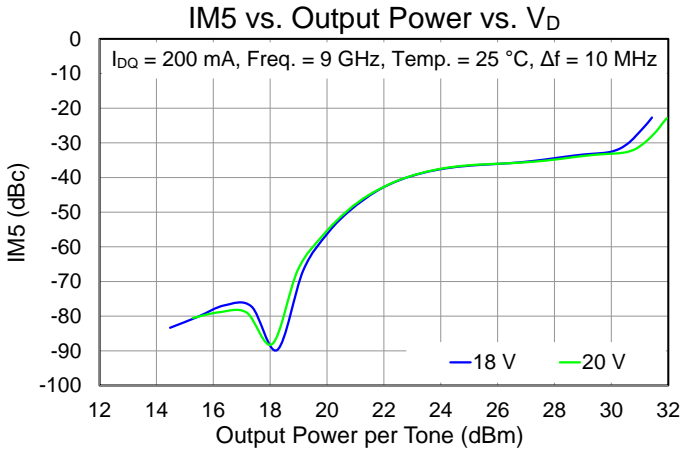

Performance Plots – Harmonics

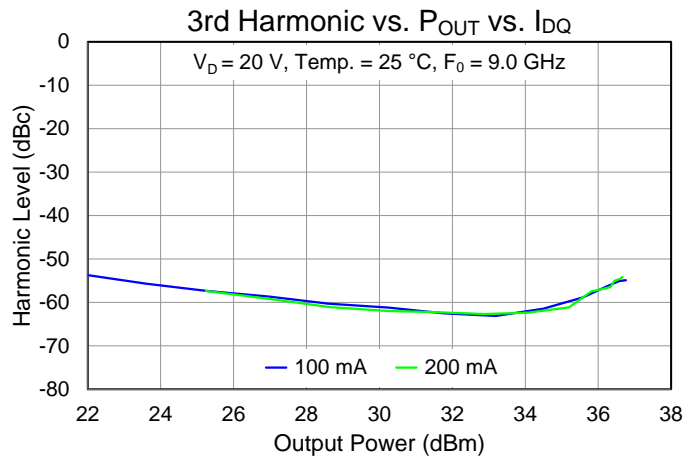
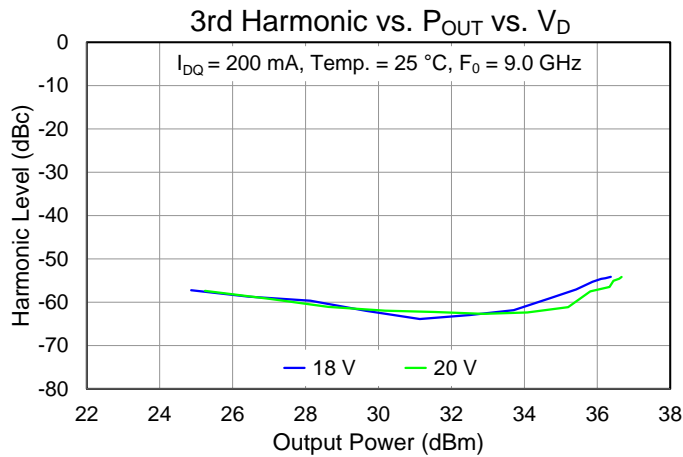
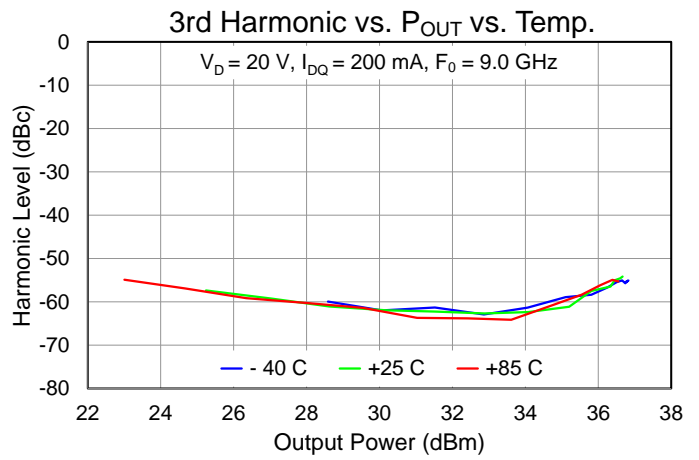
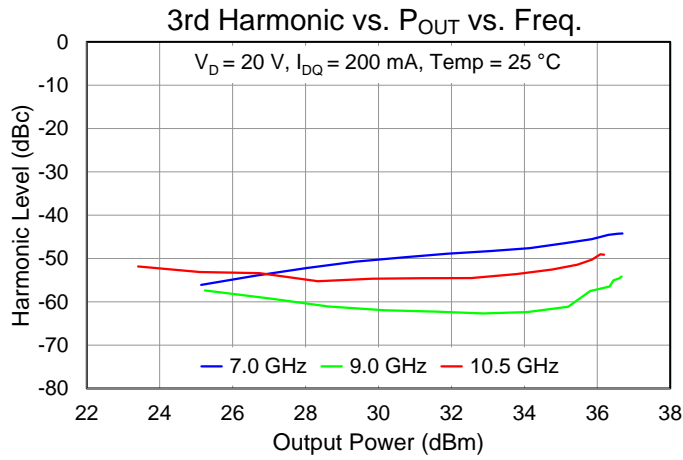

Performance Plots – Detector Voltage

Note: $V_{\Delta} = V_{REF} - V_{DET}$

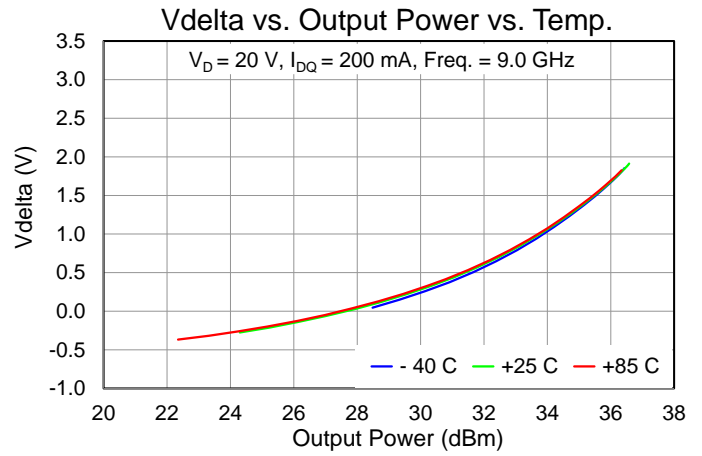
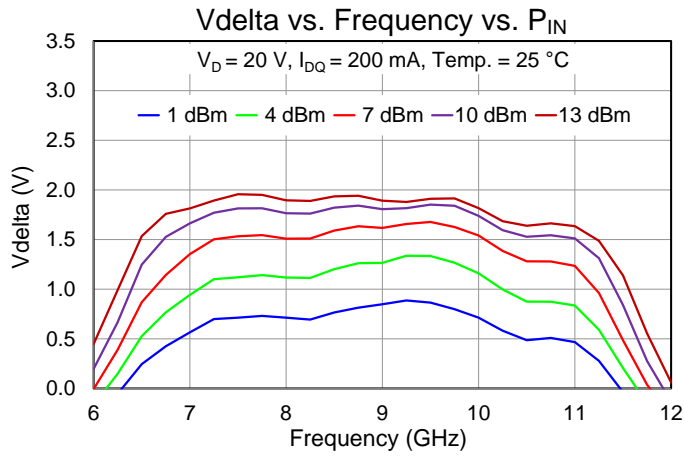
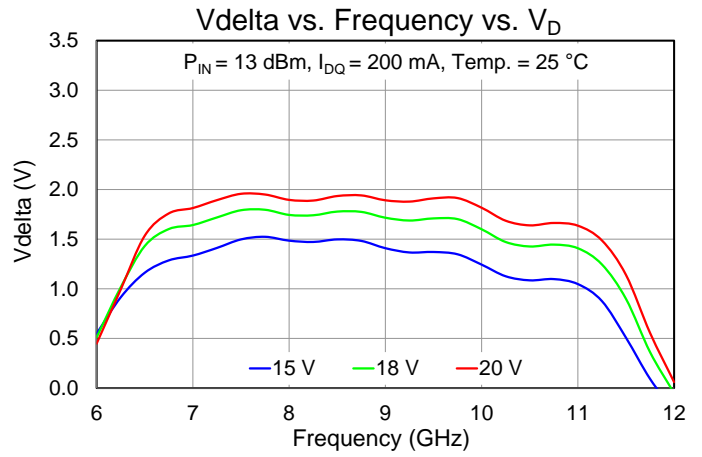
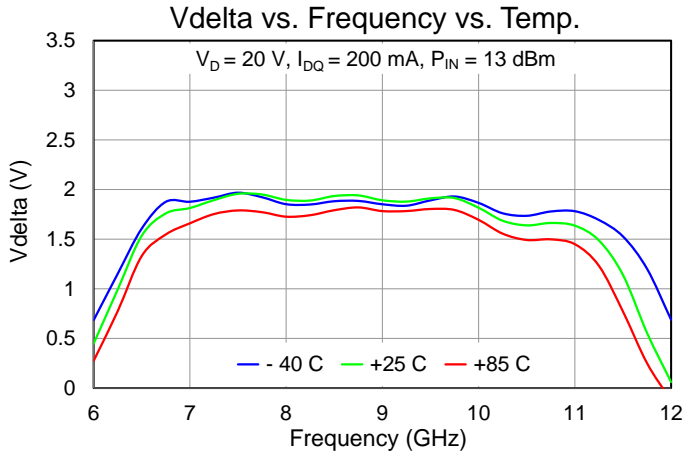

Performance Plots – Small Signal

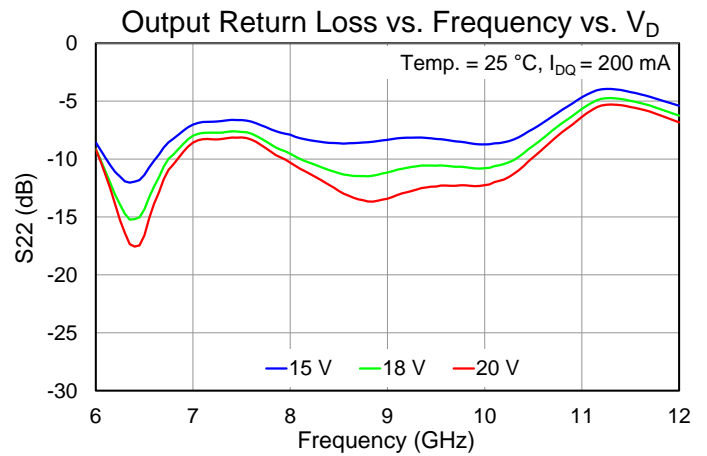
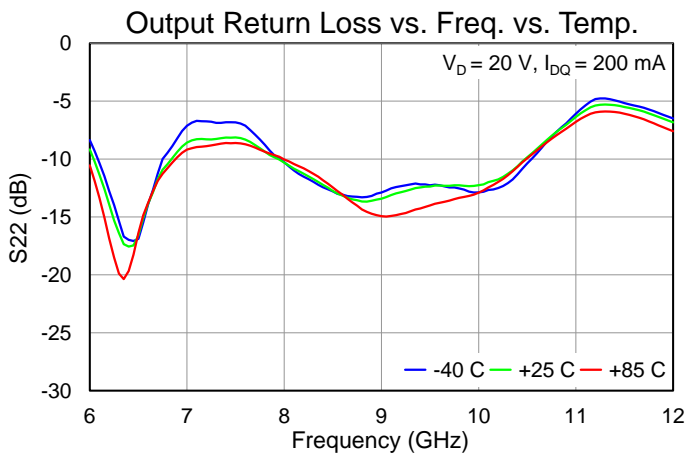
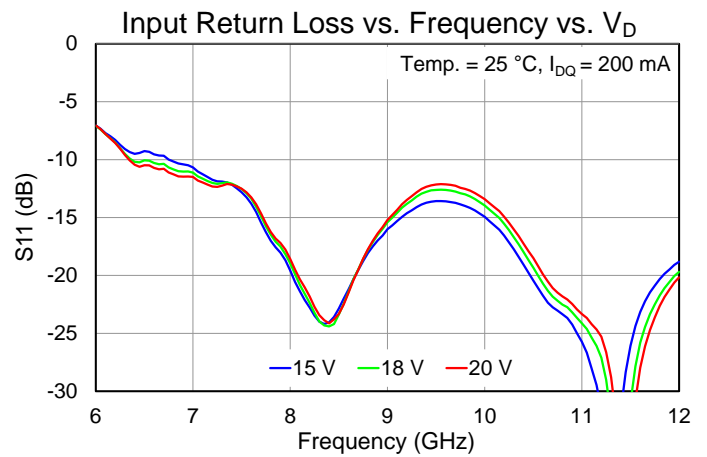
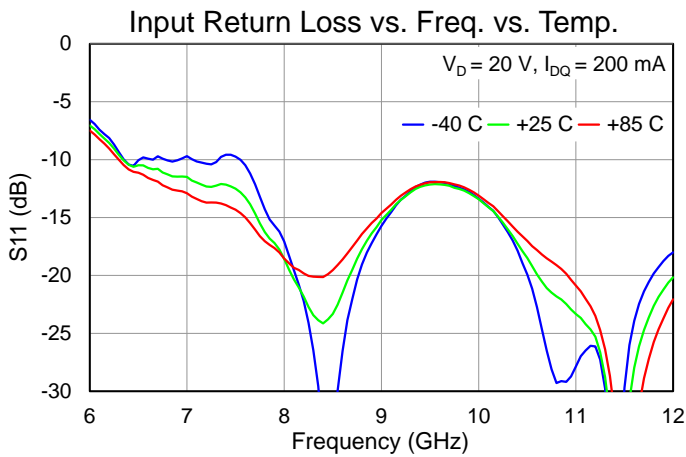
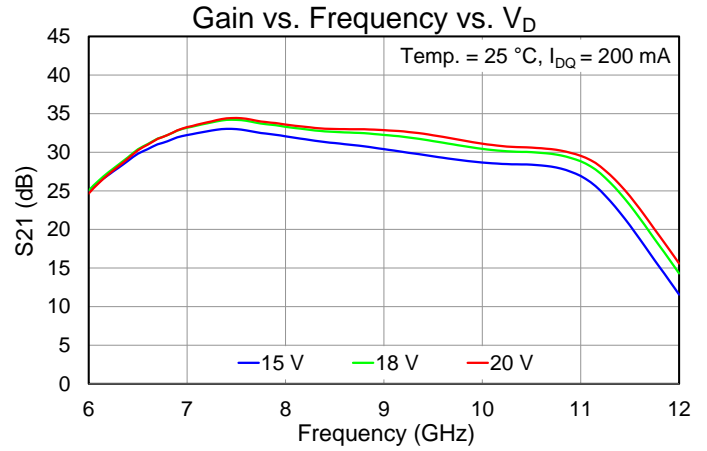
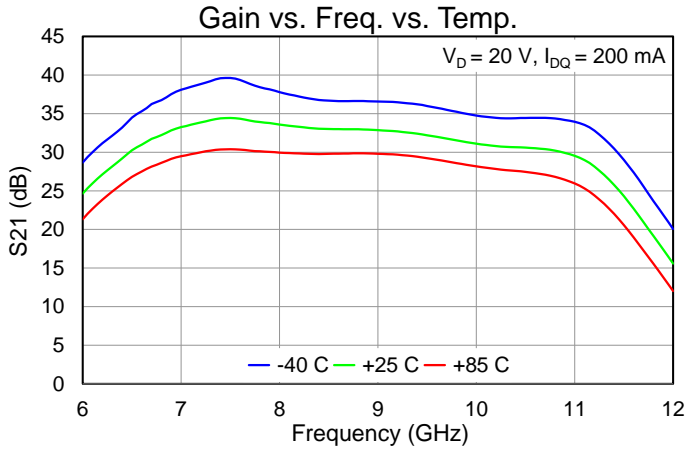

Performance Plots – Small Signal

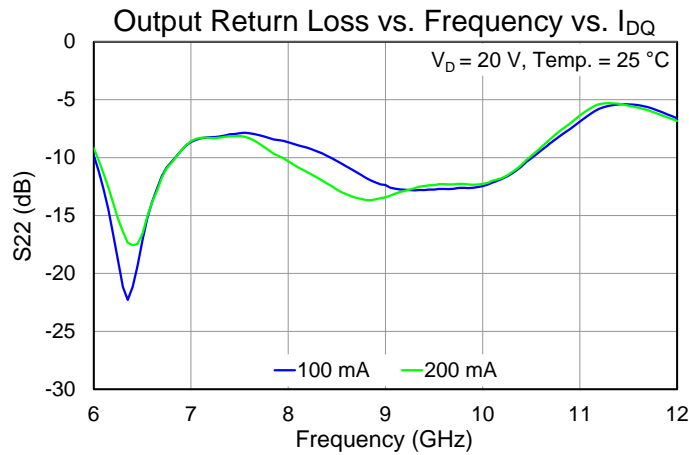
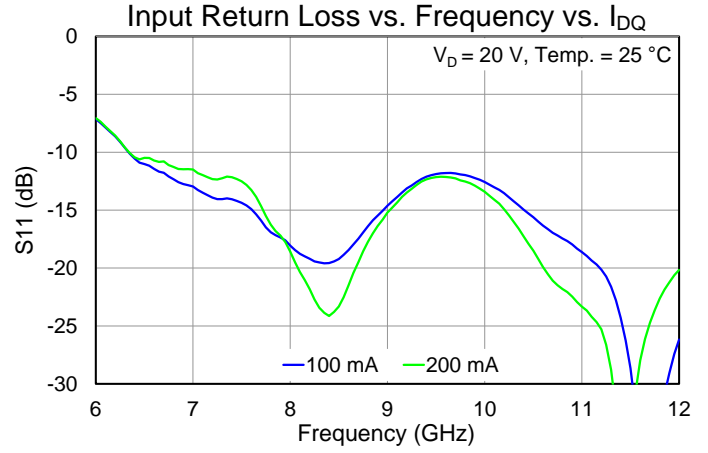
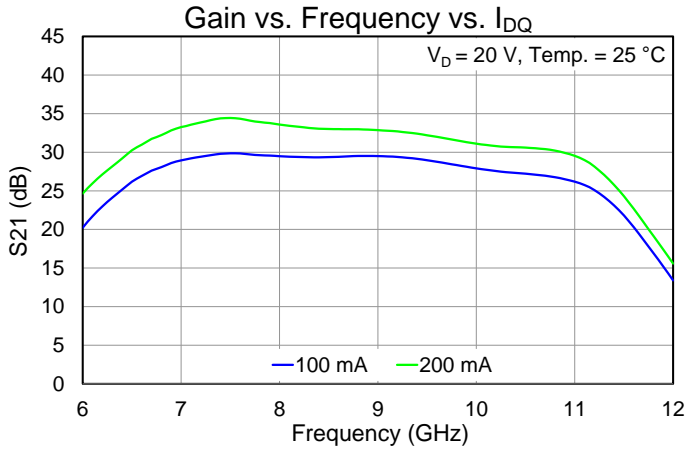

Thermal and Reliability Information

Parameter	Test Conditions	Value	Units
Thermal Resistance (θ_{JC}) ¹	$T_{BASE} = 85^\circ\text{C}$, $V_D = +20\text{ V}$, $I_{DQ} = 200\text{ mA}$, $P_{DISS} = 4.0\text{ W}$	6.13	$^\circ\text{C/W}$
Channel Temperature (T_{CH}) (Quiescent, No RF) ²		109.5	$^\circ\text{C}$
Thermal Resistance (θ_{JC}) ¹	$T_{BASE} = 85^\circ\text{C}$, $V_D = +20\text{ V}$, $I_{DQ} = 200\text{ mA}$, Freq = 7.75 GHz, $P_{IN} = 13\text{ dBm}$, $I_{D_Drive} = 569\text{ mA}$, $P_{OUT} = 36.1\text{ dBm}$, $P_{DISS} = 7.33\text{ W}$	6.52	$^\circ\text{C/W}$
Channel Temperature (T_{CH}) (Under RF drive) ²		132.8	$^\circ\text{C}$

Notes:

1. Thermal resistance referenced to the back of the package, with a fixed base temperature of 85 °C.
2. IR scan equivalent. Refer to the following document: [GaN Device Channel Temperature, Thermal Resistance, and Reliability Estimates](#)

Power Dissipation and Maximum Gate Current

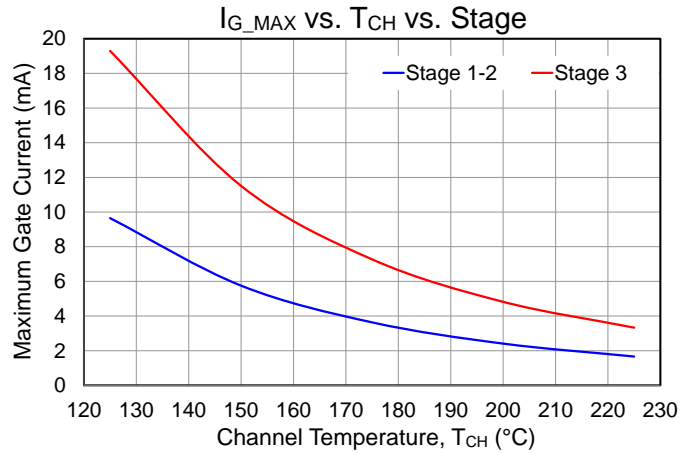
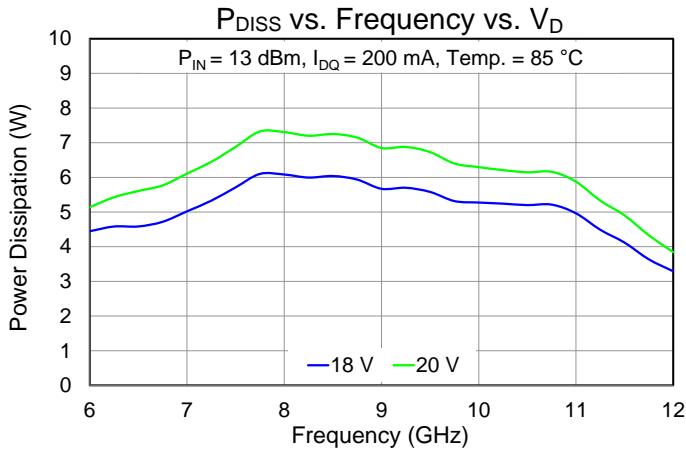

Application Information

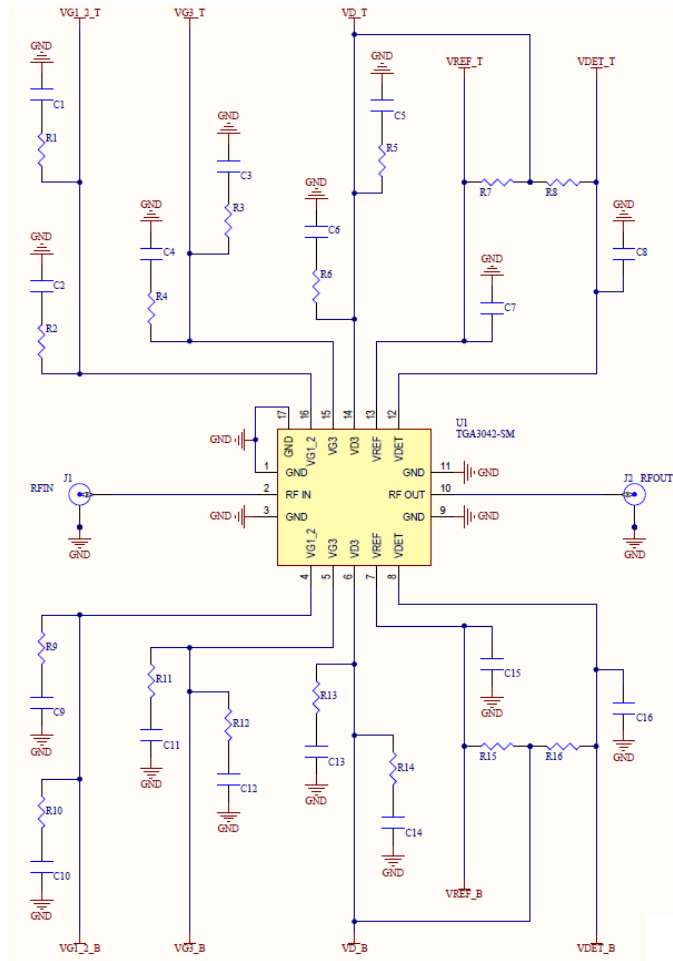

Bias Up Procedure

1. Set I_D limit to 1000 mA, I_G limit to 20 mA
2. Apply -5 V to V_G
3. Apply +20 V to V_D ; ensure I_{DQ} is approx. 0 mA
4. Adjust V_G until $I_{DQ} = 200$ mA ($V_G \sim -2.2$ V Typ.).
5. Turn on RF supply

Bias Down Procedure

1. Turn off RF supply
2. Reduce V_G to -5 V; ensure I_{DQ} is approx. 0 mA
3. Set V_D to 0 V
4. Turn off V_D supply
5. Turn off V_G supply

Evaluation Board (EVB) Layout

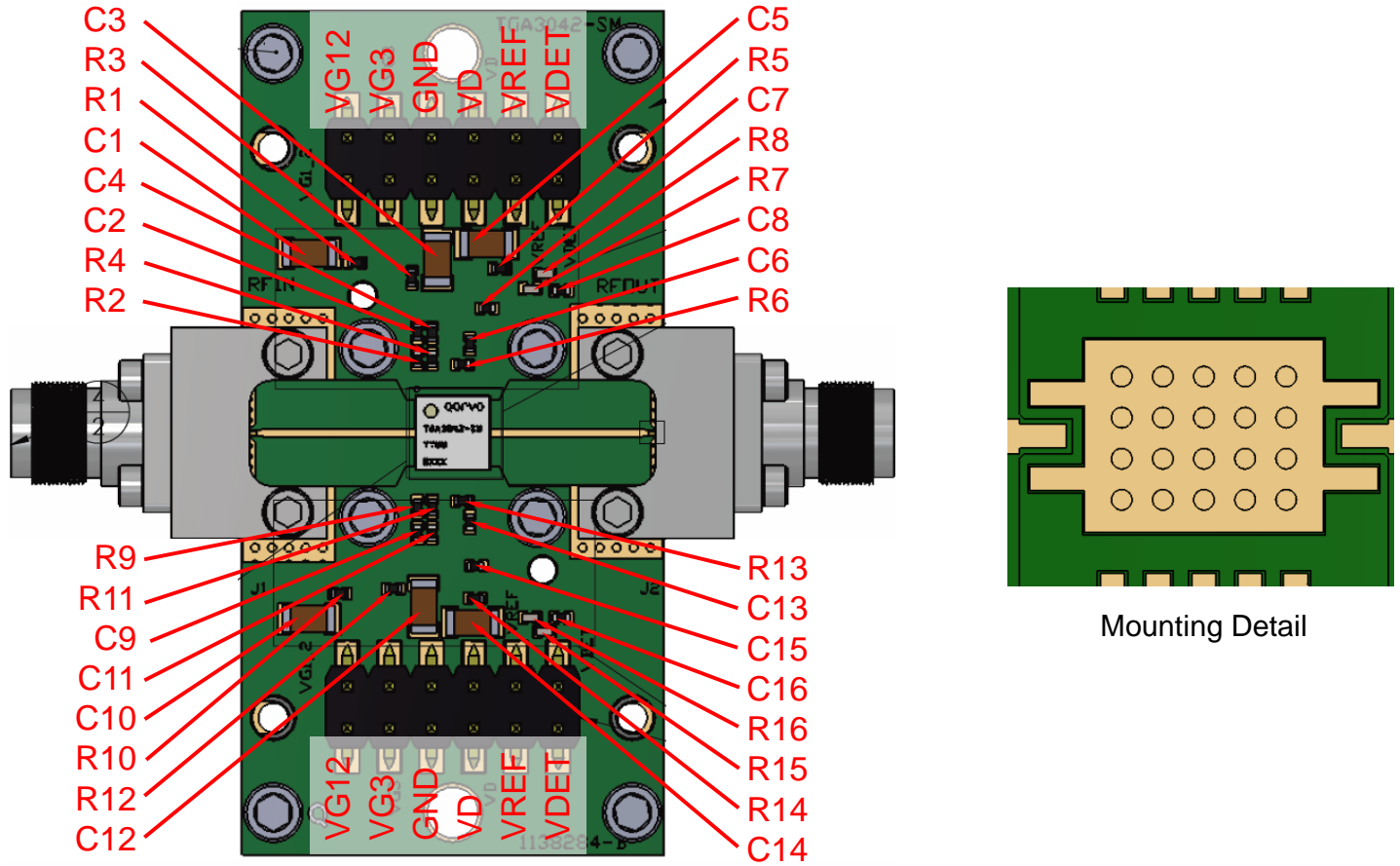

NOTES:

1. RF Layer is 8 mil thick Rogers Corp. RO4003C, $\epsilon_r = 3.38$. Both metal layers are 0.5 oz. copper.
2. TGA3042-SM can be biased from either the top side or the bottom side. Bypassing components are required for the side(s) being biased. Bypass components are required for the side not biased if using the EVB PCB layout in other applications. Do not include metal traces for applications using the EVB PCB layout if biasing and bypassing from one side only

Bill of Materials

Reference Des.	Value	Description	Manuf.	Part Number
C1, C3, C5, C10, C12, C14	1.0 uF	CAP CER 50V 5% X7R 1206	Various	
C2, C4, C6–C9, C11, C13, C15, C16	1000 pF	CAP, 0402, 1000pF, 10%, 100V, X7R	Various	
R7, R8, R15, R16	25.5 k Ω	RES, 1/16W, 1%, 0402	Various	
R1–R6, R9–R14	5.1 Ω	RES, 5%, 0402, 1/10W	Various	
J1, J2	N/A	2.92 mm RF Edge Launch Connector	Southwest Microwave	1092-01A-5

Mechanical Information

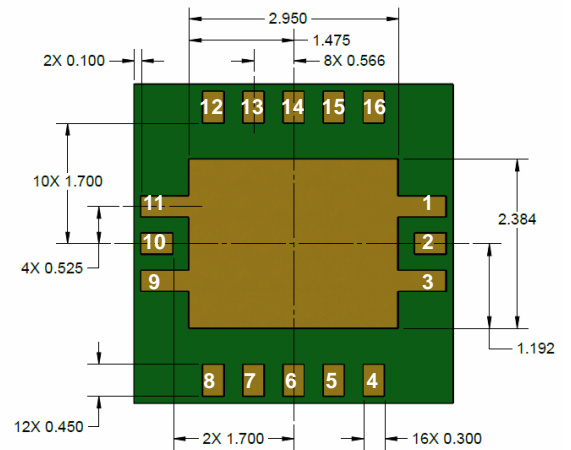
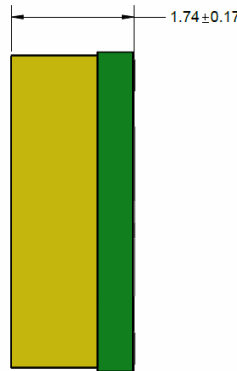
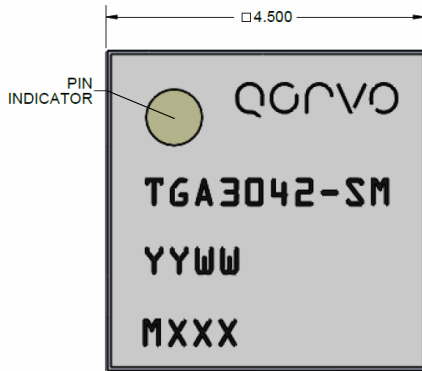

Units: millimeters

Tolerances: unless specified

x.xx = ± 0.25

x.xxx = ± 0.100

Materials:

Base: Laminate

Lid: FR4

All metalized features are gold plated

Part is epoxy sealed

Marking:

TGA3042-SM: Part number

YY: Part Assembly year

WW: Part Assembly week

MXXX: Batch ID

Pin Description

Pad No.	Symbol	Description
1, 3, 9, 11, Center	GND	Ground. Must be grounded on the PCB. Conductive filled vias recommended for least inductance and improved thermal performance (see Mounting Detail)
2	RF _{IN}	RF Input; matched to 50 Ω; DC blocked
4, 16	V _{G1-2}	Stage 1-2 Gate Voltage. Can be biased from either side. Bias network is required; see recommended Application Information and EVB Layout above.
5, 15	V _{G3}	Stage 3 Gate Voltage. Can be biased from either side. Bias network is required; see recommended Application Information and EVB Layout above.
6, 14	V _D	Drain voltage; Drain can be biased from either side. Bias network is required; see recommended Application Information and EVB Layout above.
7, 13	V _{REF}	Reference voltage
8, 12	V _{DET}	Detector voltage
10	RF _{OUT}	RF Output; matched to 50 Ω; DC blocked

Assembly Notes

Compatible with lead-free soldering processes with 260°C peak reflow temperature.

This package is air-cavity and non-hermetic, and therefore cannot be subjected to aqueous washing. The use of no-clean solder to avoid washing after soldering is highly recommended.

Contact plating: Ni-Au.

Solder rework not recommended.

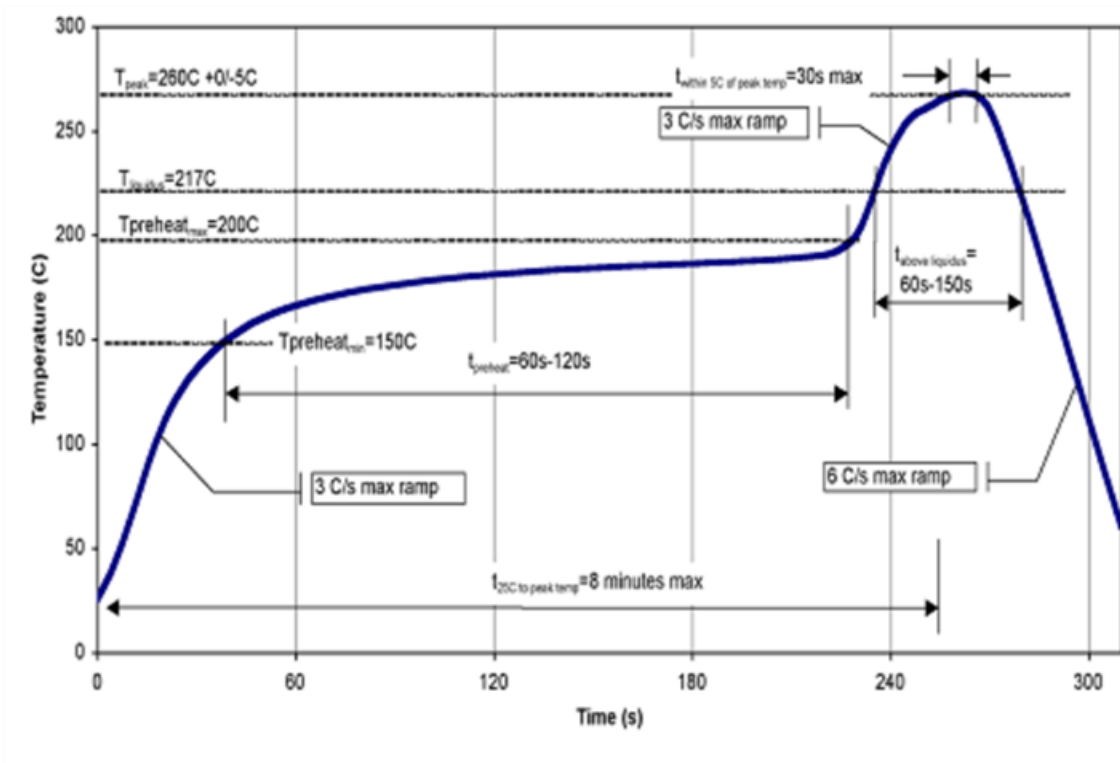

Recommended Soldering Temperature Profile

Handling Precautions

Parameter	Rating	Standard
ESD – Human Body Model (HBM)	0B	ESDA / JEDEC JS-001-2017
ESD – Charged Device Model (CDM)	C2a	ESDA / JEDEC JS-002-2018
MSL – Convection Reflow 260 °C	3	JEDEC standard IPC/JEDEC J-STD-020



Caution!
ESD-Sensitive Device

RoHS Compliance

This product is compliant with the 2011/65/EU RoHS directive (Restrictions on the Use of Certain Hazardous Substances in Electrical and Electronic Equipment), as amended by Directive 2015/863/EU.

This product also has the following attributes:

- Lead Free
- Antimony Free
- TBBP-A (C₁₅H₁₂Br₄O₂) Free
- PFOS Free

Contact Information

For the latest specifications, additional product information, worldwide sales and distribution locations:

Web: www.qorvo.com

Tel: 1-844-890-8163

Email: customer.support@qorvo.com

Important Notice

The information contained herein is believed to be reliable; however, Qorvo makes no warranties regarding the information contained herein and assumes no responsibility or liability whatsoever for the use of the information contained herein. All information contained herein is subject to change without notice. Customers should obtain and verify the latest relevant information before placing orders for Qorvo products. The information contained herein or any use of such information does not grant, explicitly or implicitly, to any party any patent rights, licenses, or any other intellectual property rights, whether with regard to such information itself or anything described by such information. **THIS INFORMATION DOES NOT CONSTITUTE A WARRANTY WITH RESPECT TO THE PRODUCTS DESCRIBED HEREIN, AND QORVO HEREBY DISCLAIMS ANY AND ALL WARRANTIES WITH RESPECT TO SUCH PRODUCTS WHETHER EXPRESS OR IMPLIED BY LAW, COURSE OF DEALING, COURSE OF PERFORMANCE, USAGE OF TRADE OR OTHERWISE, INCLUDING THE IMPLIED WARRANTIES OF MERCHANTABILITY AND FITNESS FOR A PARTICULAR PURPOSE.**

Without limiting the generality of the foregoing, Qorvo products are not warranted or authorized for use as critical components in medical, life-saving, or life-sustaining applications, or other applications where a failure would reasonably be expected to cause severe personal injury or death.

© 2020 Qorvo US, Inc. All rights reserved. This document is subject to copyright laws in various jurisdictions worldwide and may not be reproduced or distributed, in whole or in part, without the express written consent of Qorvo US, Inc.

Mouser Electronics

Authorized Distributor

Click to View Pricing, Inventory, Delivery & Lifecycle Information:

[Qorvo:](#)

[TGA3042-SM](#)