



TGA4544-SM

26 – 31 GHz 1 Watt Power Amplifier

Product Overview

The Qorvo TGA4544-SM is a Ka-Band Power Amplifier with integrated power detector. The TGA4544-SM operates from 26 – 31 GHz and is designed using Qorvo’s power pHEMT production process.

The TGA4544-SM typically provides 32 dBm of saturated output power with small signal gain of 23 dB. Third Order Intercept is 41 dBm at 20 dBm SCL.

The TGA4544-SM is available in a low-cost, surface mount 26 lead 5x5 ACQFN package and is ideally suited for Point-to-Point Radio.

Lead-free and RoHS compliant



26 Lead 5 x 5 mm ACQFN package

Key Features

- Frequency Range: 26 – 31 GHz
- Power: 32 dBm Psat, 31 dBm P1dB
- Gain: 23 dB
- TOI: 41 dBm at 20 dBm/tone
- Integrated Power Detector
- Bias: $V_d = 6\text{ V}$, $I_{dq} = 1100\text{ mA}$, $V_g = -0.55\text{ V}$ Typical
- Package Dimensions: 5.0 x 5.0 x 1.3 mm

Performance is typical across frequency. Please reference electrical specification table and data plots for more details.

Functional Block Diagram

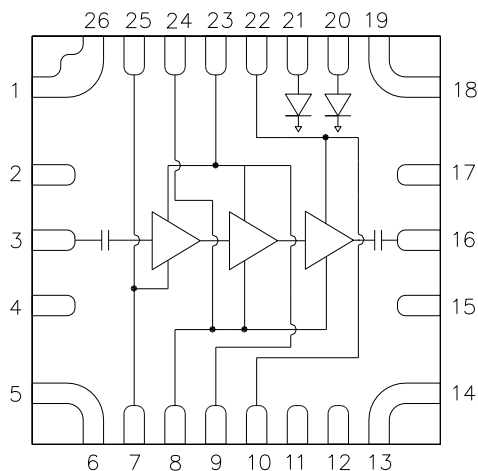

Applications

- Point-to-Point Radio
- Ka-band Sat-Com

Ordering Information

Part No.	Description
TGA4544-SM	26 – 31 GHz 1W Power Amplifier
TGA4544-SM-T/R	200 pieces on a 7" reel (standard)
TGA4544-SMEVB	Evaluation Board for TGA4544-SM

Absolute Maximum Ratings

Parameter	Value / Range
Drain Voltage (V_D)	6.5 V
Gate Voltage Range (V_G)	-3.5 V to 0 V
Drain to Gate Voltage, $V_D - V_G$	10 V
Drain Current (I_D)	2.5 A
Gate Current (I_G)	-7 to +52 mA
Power Dissipation (P_{DISS}), $T_{BASE} = 85^\circ\text{C}$	16.2 W
Input Power (P_{IN}), 50 Ω , $V_D = 6\text{ V}$, $I_{DQ} = 1.1\text{ A}$, 25°C	25 dBm
Channel Temperature, T_{CH}	200 $^\circ\text{C}$
Mounting Temperature (30 sec)	260 $^\circ\text{C}$
Storage Temperature	-55 to +155 $^\circ\text{C}$

Operation of this device outside the parameter ranges given above may cause permanent damage. These are stress ratings only, and functional operation of the device at these conditions is not implied.

Recommended Operating Conditions

Parameter	Min	Typ.	Max	Units
Drain Voltage (V_D)		+6		V
Drain Current, Quiescent (I_{DQ})		1.1		A
Drain Current, RF (I_{D_Drive})		1.7		A
Gate Voltage Typ. Range (V_G)	-0.3 to -0.75			V
Gate Current, RF (I_{G_Drive})		15		mA
Input Power at P_{SAT} (P_{IN})	-40 $^\circ\text{C}$, -14 dBm			dBm
	+25 $^\circ\text{C}$, -15 dBm			
	+85 $^\circ\text{C}$, -16 dBm			
Operating Temp. Range (T_{BASE})	-40		+85	$^\circ\text{C}$

Electrical specifications are measured at specified test conditions. Specifications are not guaranteed over all recommended operating conditions.

Electrical Specifications

Parameter	Conditions ⁽¹⁾ ⁽²⁾	Min	Typ.	Max	Units
Operational Frequency Range		26		31	GHz
Output Power at Saturation, P_{SAT}	$P_{IN} = 15\text{ dBm}$		32		dBm
Output Power at 1 dB Gain Compression, P_{1dB}			31		dBm
Small Signal Gain, S_{21}			23		dB
Input Return Loss, IRL	CW		8		dB
Output Return Loss, ORL	CW		10		dB
Output TOI	$P_{OUT/TONE} = 20\text{ dBm}$		41		dBm
P_{SAT} Temperature Coefficient	$T_{DIFF} = -40^\circ\text{C}$ to $+85^\circ\text{C}$; $P_{IN} = 15\text{ dBm}$		-0.01		dBm/ $^\circ\text{C}$
S_{21} Temperature Coefficient	$T_{DIFF} = -40^\circ\text{C}$ to $+85^\circ\text{C}$		-0.03		dB/ $^\circ\text{C}$

Notes:

1. Test conditions unless otherwise noted: Pulsed RF, $V_D = +6\text{ V}$, $I_{DQ} = 1.1\text{ A}$, $V_G = -0.55\text{ V}$ +/- typical, $T_{BASE} = +25^\circ\text{C}$, $Z_0 = 50\ \Omega$
2. T_{BASE} is back side of TGA4544-SM

Performance Plots – Large Signal

Test conditions, unless otherwise noted: $V_D = 6\text{ V}$, $I_{DQ} = 1.1\text{ A}$, $P_{IN} = 15\text{ dBm}$, $T_{BASE} = +25\text{ }^\circ\text{C}$

Psat vs. Frequency vs. Temperature
 $V_d = 6\text{ V}$, $I_d = 1100\text{ mA}$, $V_g = -0.58\text{ V}$ Typical

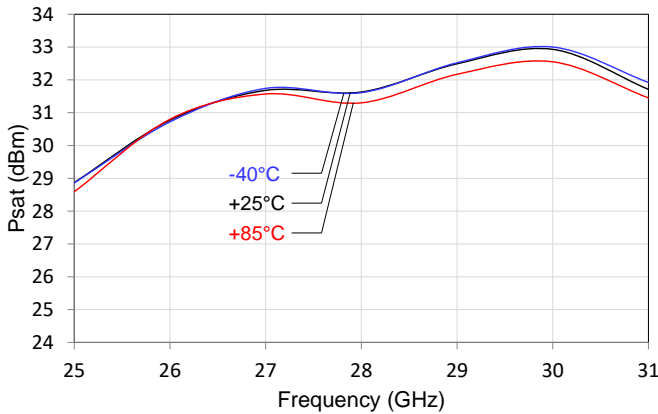

P1dB vs. Frequency vs. Temperature
 $V_d = 6\text{ V}$, $I_d = 1100\text{ mA}$, $V_g = -0.58\text{ V}$ Typical

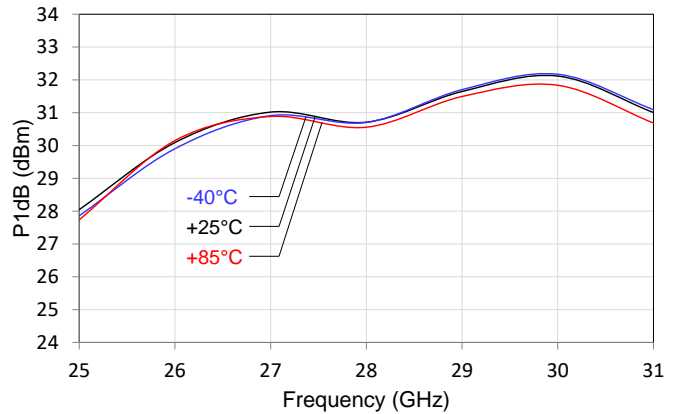

Psat vs. Frequency vs. Bias
 $V_d = 5 - 6\text{ V}$, $I_d = 900 - 1300\text{ mA}$, $V_g = -0.58\text{ V}$ Typical

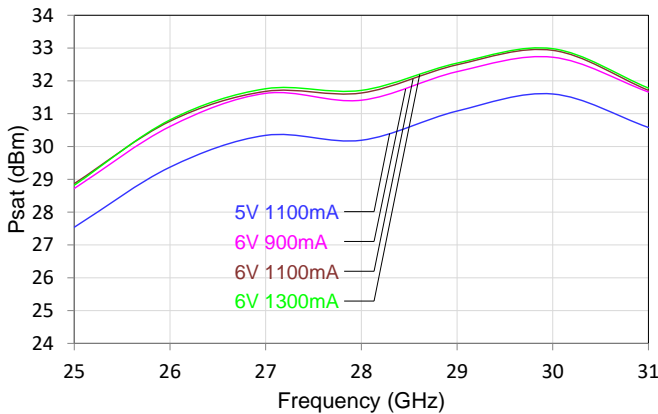

P1dB vs. Frequency vs. Bias
 $V_d = 5 - 6\text{ V}$, $I_d = 900 - 1300\text{ mA}$, $V_g = -0.58\text{ V}$ Typical

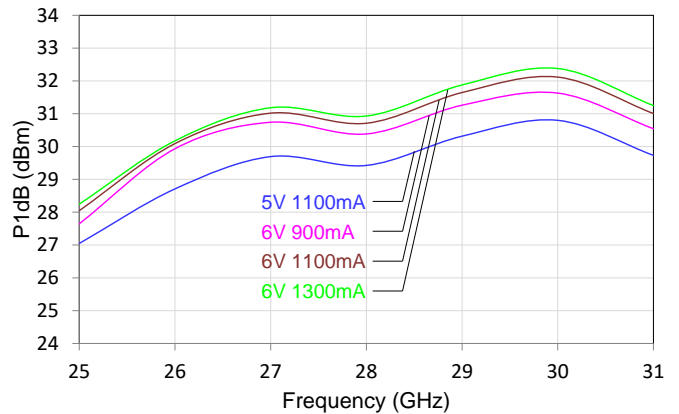

Output Power vs. Frequency
 $V_d = 6\text{ V}$, $I_d = 1100\text{ mA}$, $V_g = -0.58\text{ V}$ Typical

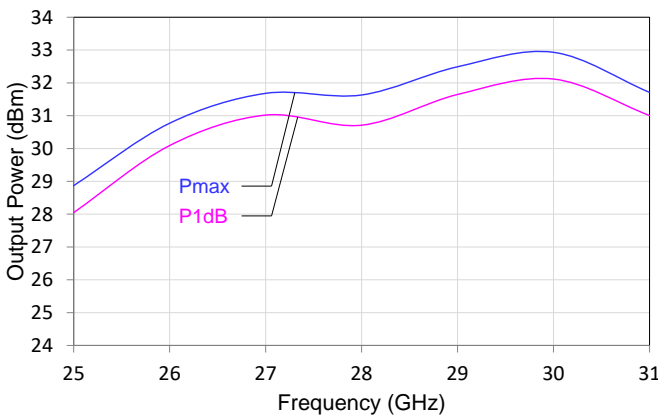

Pout, Gain, Id vs. Pin @ 28GHz
 $V_d = 6\text{ V}$, $I_d = 1100\text{ mA}$, $V_g = -0.58\text{ V}$ Typical

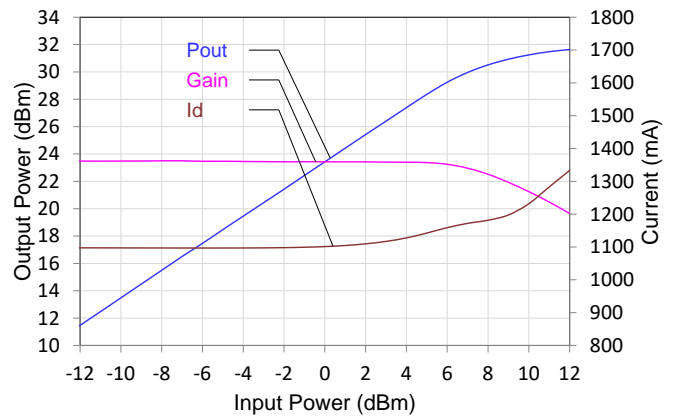

Performance Plots – Small Signal

Test conditions, unless otherwise noted: $V_D = 6\text{ V}$, $I_{DQ} = 1.1\text{ A}$, $T_{BASE} = +25\text{ }^\circ\text{C}$

Gain vs. Frequency vs. Temperature
 $V_d = 6\text{ V}$, $I_d = 1100\text{ mA}$, $V_g = -0.58\text{ V}$ Typical

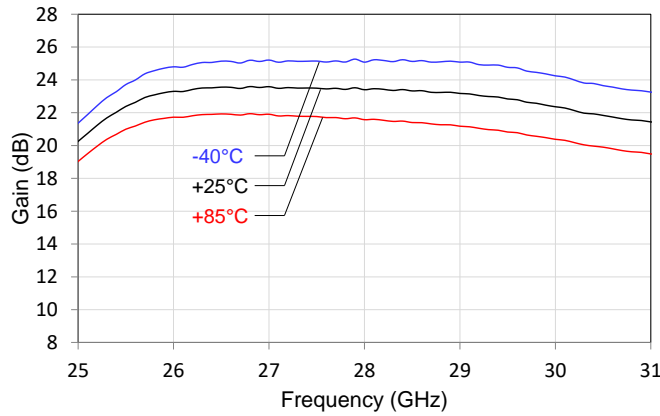

S-Parameters vs. Frequency
 $V_d = 6\text{ V}$, $I_d = 1100\text{ mA}$, $V_g = -0.58\text{ V}$ Typical, $+25\text{ }^\circ\text{C}$

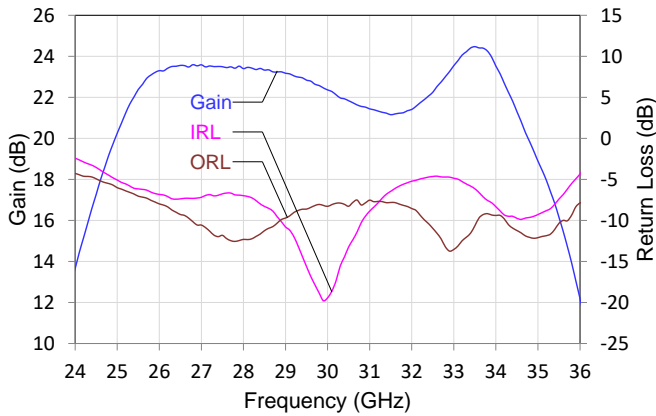

Gain vs. Frequency vs. Bias
 $V_d = 5 - 6\text{ V}$, $I_d = 900 - 1300\text{ mA}$, $V_g = -0.58\text{ V}$ Typical

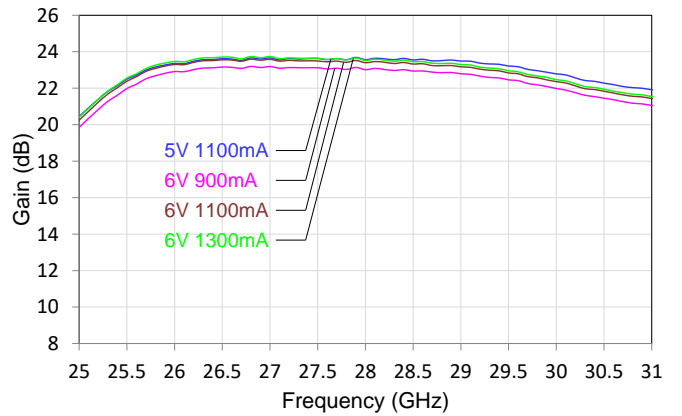

Performance Plots – Other

Test conditions, unless otherwise noted: $V_D = 6\text{ V}$, $I_{DQ} = 1.1\text{ A}$, $T_{BASE} = +25\text{ }^\circ\text{C}$

Power Detector vs. Pout vs. Temperature
 $V_d = 6\text{ V}$, $I_d = 1100\text{ mA}$, $V_g = -0.58\text{ V}$ Typical

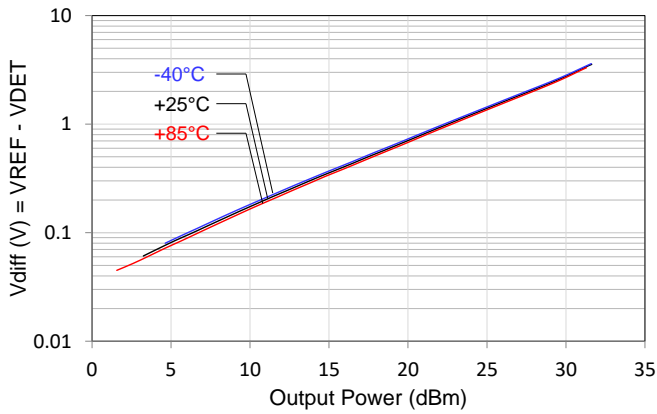

Power Detector vs. Pout vs. Bias @ 28GHz
 $V_d = 5 - 6\text{ V}$, $I_d = 900 - 1300\text{ mA}$, $V_g = -0.58\text{ V}$ Typical

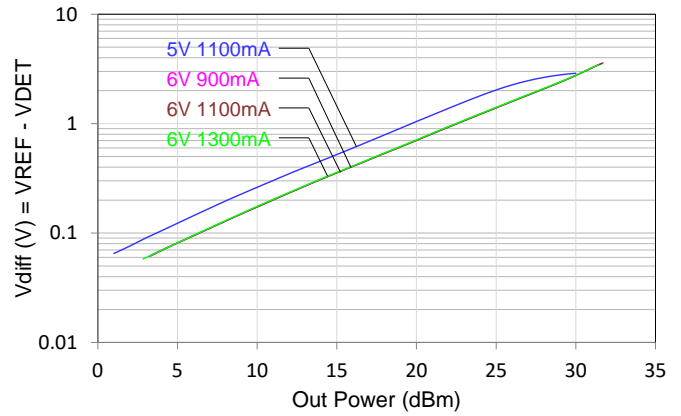

Noise vs. Frequency vs. Bias
 $V_d = 5 - 6\text{ V}$, $I_d = 900 - 1300\text{ mA}$, $V_g = -0.58\text{ V}$ Typical

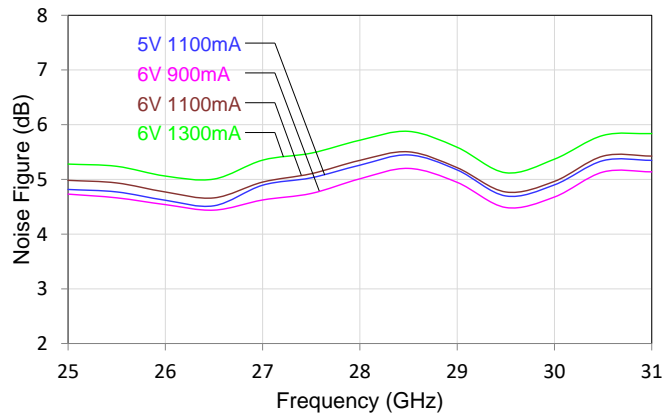

Performance Plots –Linearity

Test conditions, unless otherwise noted: $V_D = 6\text{ V}$, $I_{DQ} = 1.1\text{ A}$, $T_{BASE} = +25\text{ }^\circ\text{C}$

Output TOI vs. Frequency vs. Temperature

$V_d = 6\text{ V}$, $I_d = 1100\text{ mA}$, $V_g = -0.58\text{ V}$ Typical

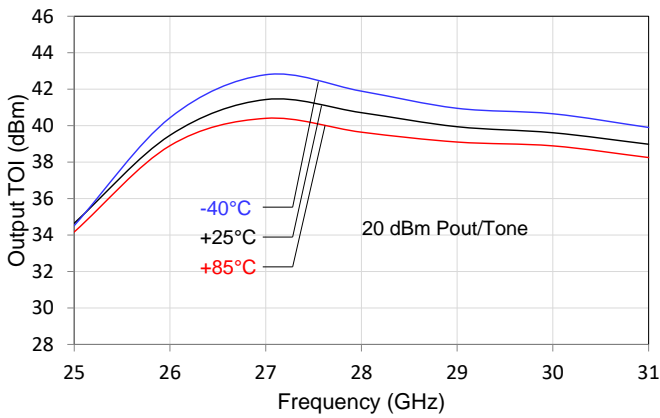

Output TOI vs. Frequency vs. Bias

$V_d = 5 - 6\text{ V}$, $I_d = 900 - 1300\text{ mA}$, $V_g = -0.58\text{ V}$ Typical

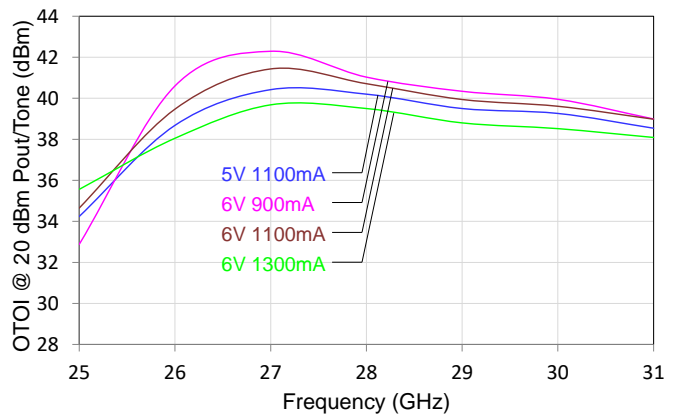

Output TOI vs. Frequency

$V_d = 6\text{ V}$, $I_d = 1100\text{ mA}$, $V_g = -0.58\text{ V}$ Typical, $25\text{ }^\circ\text{C}$

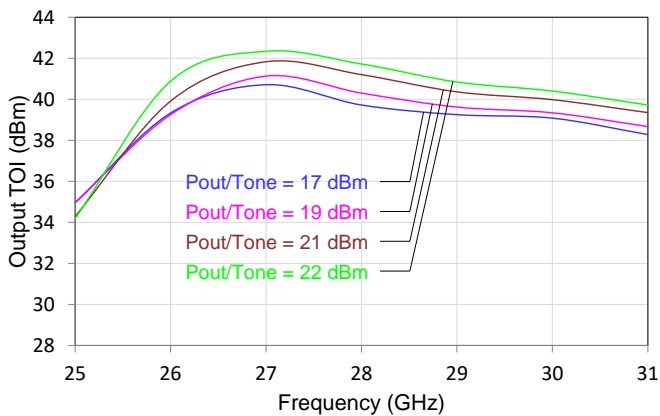

Output TOI vs. Frequency

$V_d = 6\text{ V}$, $I_d = 1100\text{ mA}$, $V_g = -0.58\text{ V}$ Typical, $25\text{ }^\circ\text{C}$

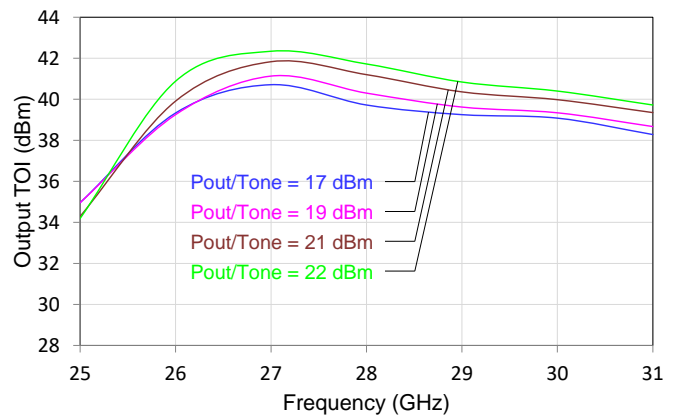

Thermal and Reliability Information

Parameter	Test Conditions	Value	Units
Thermal Resistance (θ_{JC}) ⁽¹⁾	$T_{base} = 85\text{ }^{\circ}\text{C}$, $V_D = 6\text{ V}$, $I_{DQ} = 1.1\text{ A}$, $P_{DISS} = 6.6\text{ W}$, No RF (quiescent DC operation)	10	$^{\circ}\text{C/W}$
Channel Temperature, T_{CH} (Under RF) ⁽²⁾		151	$^{\circ}\text{C}$
Thermal Resistance (θ_{JC}) ⁽¹⁾	$T_{base} = 85\text{ }^{\circ}\text{C}$, $V_D = 6\text{ V}$, $I_{DQ} = 1.1\text{ A}$, Freq = 31 GHz, $I_{D_Drive} = 1.65\text{ A}$, $P_{IN} = 16\text{ dBm}$, $P_{OUT} = 31.7\text{ dBm}$, $P_{DISS} = 8.4\text{ W}$	10	$^{\circ}\text{C/W}$
Channel Temperature, T_{CH} (Under RF) ⁽²⁾		170	$^{\circ}\text{C}$

Notes:

1. Thermal resistance determined to the back of package, T_{BASE} (85 $^{\circ}\text{C}$)

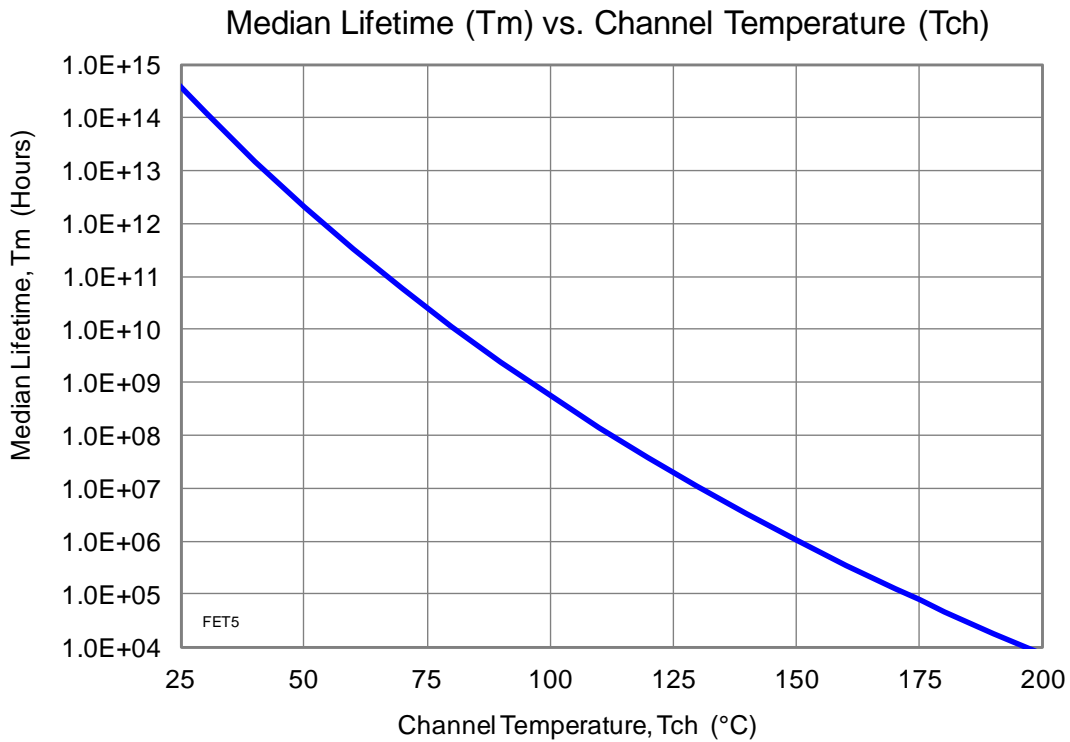

Applications Circuit

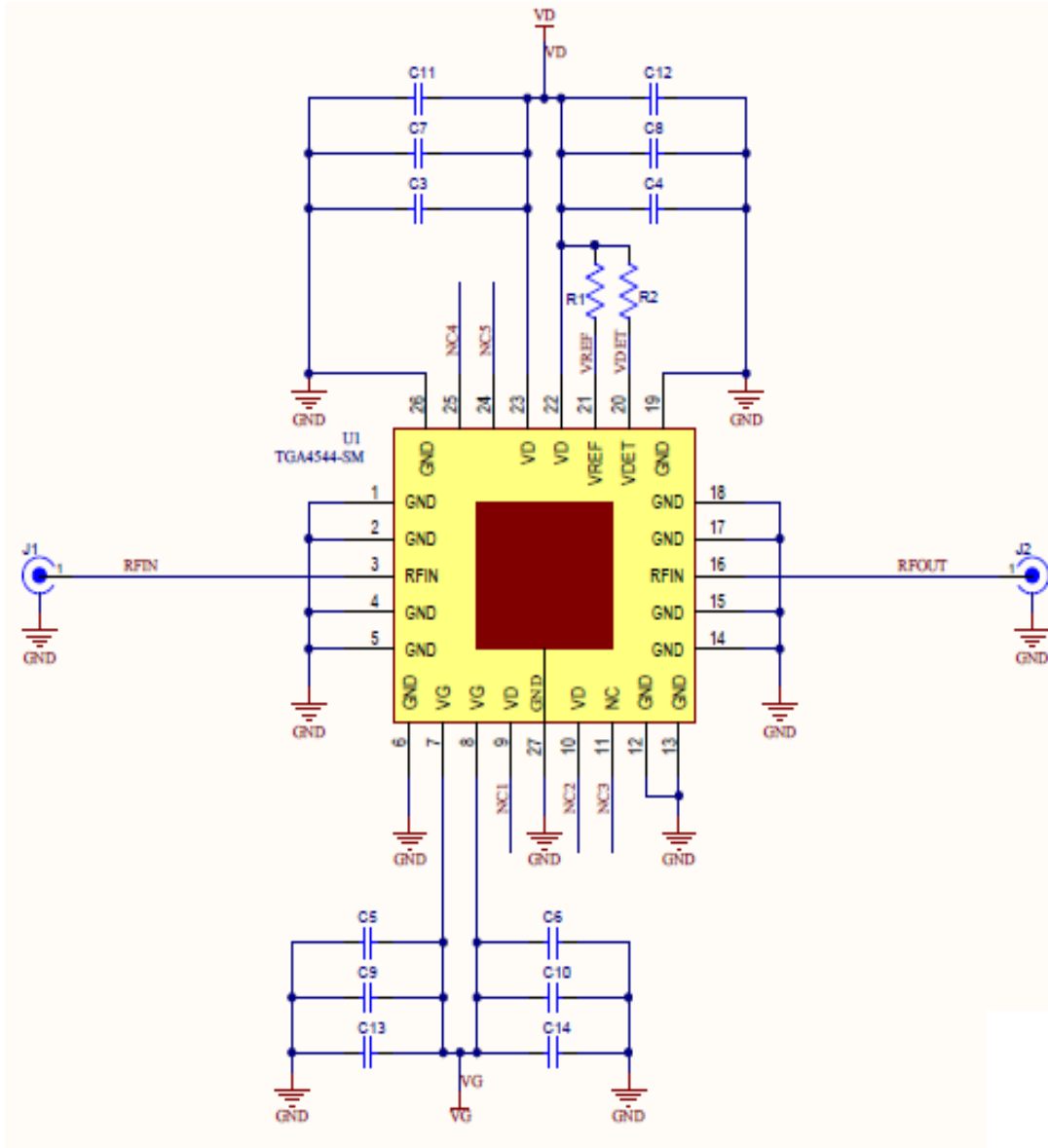

Vd, Vg can be biased from either side (top or bottom)

Bias-Up Procedure

1. Set I_D limit to 2 A, I_G limit to 20 mA
2. Set V_G to -1.5 V
3. Set V_D +6 V
4. Adjust V_G more positive until $I_{DQ} = 1.1$ A
5. Apply RF signal

Bias-Down Procedure

1. Turn off RF signal
2. Reduce V_G to -1.5 V. Ensure $I_{DQ} \sim 0$ mA
4. Set V_D to 0 V
5. Turn off V_D supply
6. Turn off V_G supply

Evaluation Board (EVB) Layout

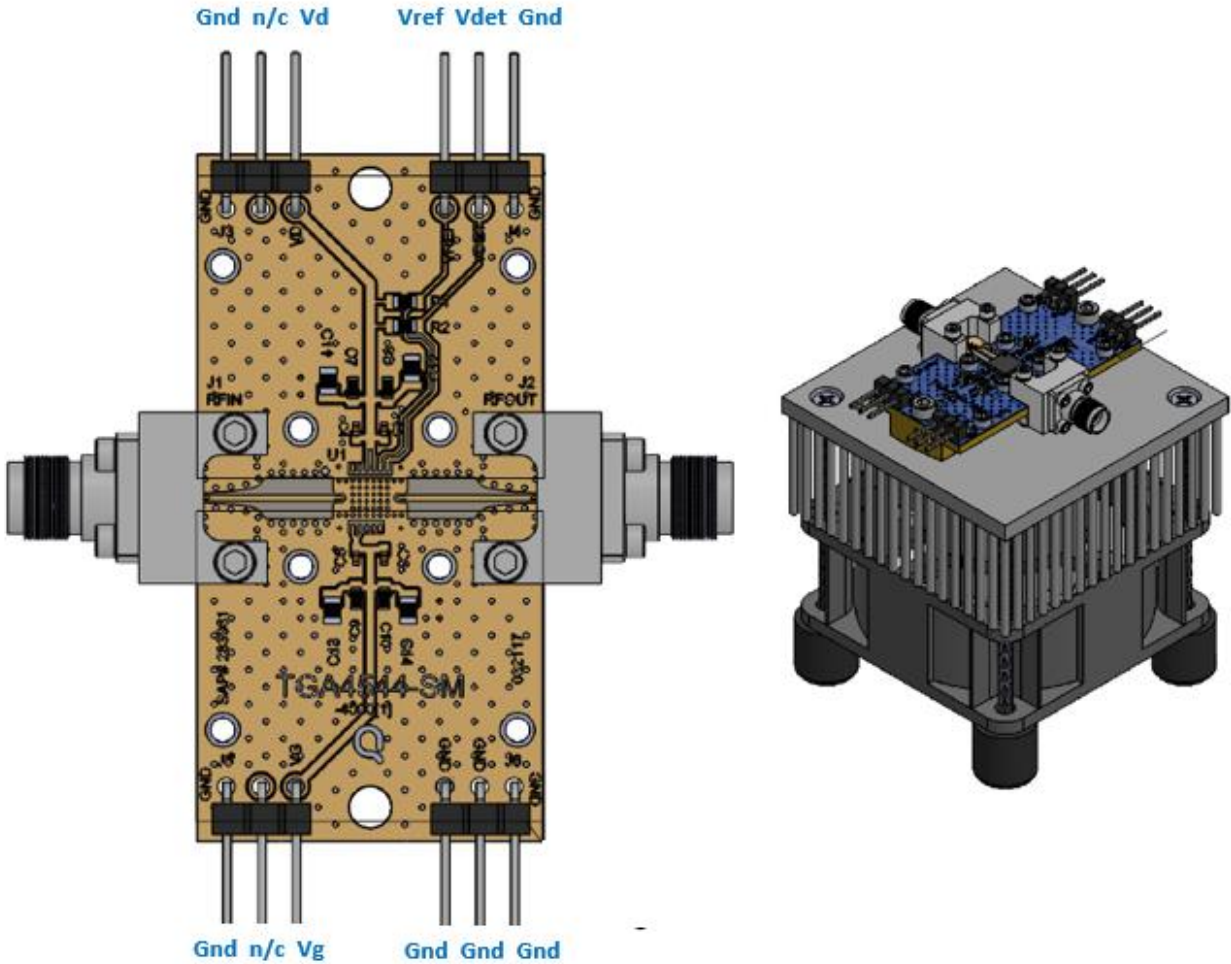

PCB board material is Rogers Corp. 4003 0.008" thickness with ½ oz copper cladding.
For further technical information, refer to the [TGA4544-SM](#) Product Information page

Bill of Materials

Reference Des.	Value	Description	Manuf.	Part Number
U1		26-31 GHz 1 W Power Amplifier	Qorvo	TGA4544-SM
C3 – C6	100 pF	CAP, 100pF, 5%, 50 V, COG, 0402	Various	
C7 – C10	1 uF	CAP, 1 uF, 10%, 50 V, X7R, 0603	Various	
C11 – C14	10 µF	CAP, 10 uF, 20%, 25 V, STD, 0803	Various	
R1, R2	47.5k Ω	RES, 47.5k, 1%, 1/10W, 0603	Various	

Pin Description

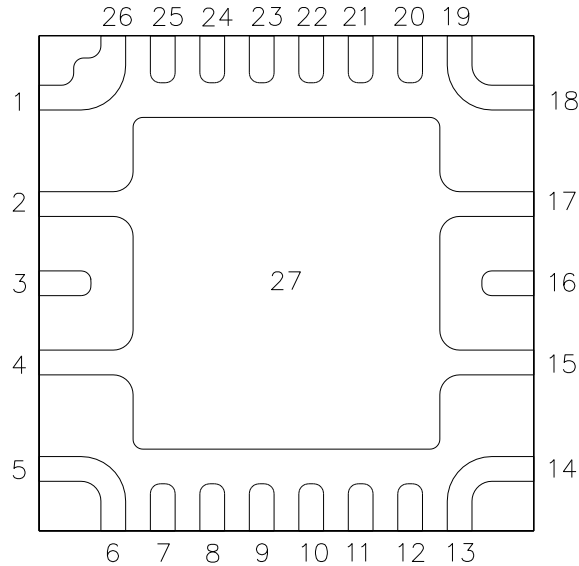

Pin No.	Label	Description
1, 5, 6, 13 14, 18, 19, 26	GND	Must be connected to Ground
2, 4, 15, 17	GND	Backside paddle. Multiple vias should be employed to minimize inductance and thermal resistance; see 'PCB Mounting Pattern' on page 12 for suggested footprint
3	RF IN	RF input; DC blocked, matched to 50 ohms
7, 25	VG1	Stage 1 gate voltage ⁽¹⁾
8, 24	VG23	Stage 2 and 3 gate voltage ⁽¹⁾
9, 23	VD12	Stage 1 and 2 drain voltage ⁽¹⁾
10, 22	VD3	Stage 3 drain voltage ⁽¹⁾
11	NC	No internal connection; recommend to be grounded on the PCB
12	GND	Internally connected to GND; recommend to be grounded on the PCB
16	RF OUT	RF output; DC blocked, matched to 50 ohms
20	VDET	Detector diode output voltage. Varies with RF output power
21	VREF	Reference diode output voltage

(1) Bias bypass network is required; see 'Application Circuit' on page 8 as an example.

Mechanical Information

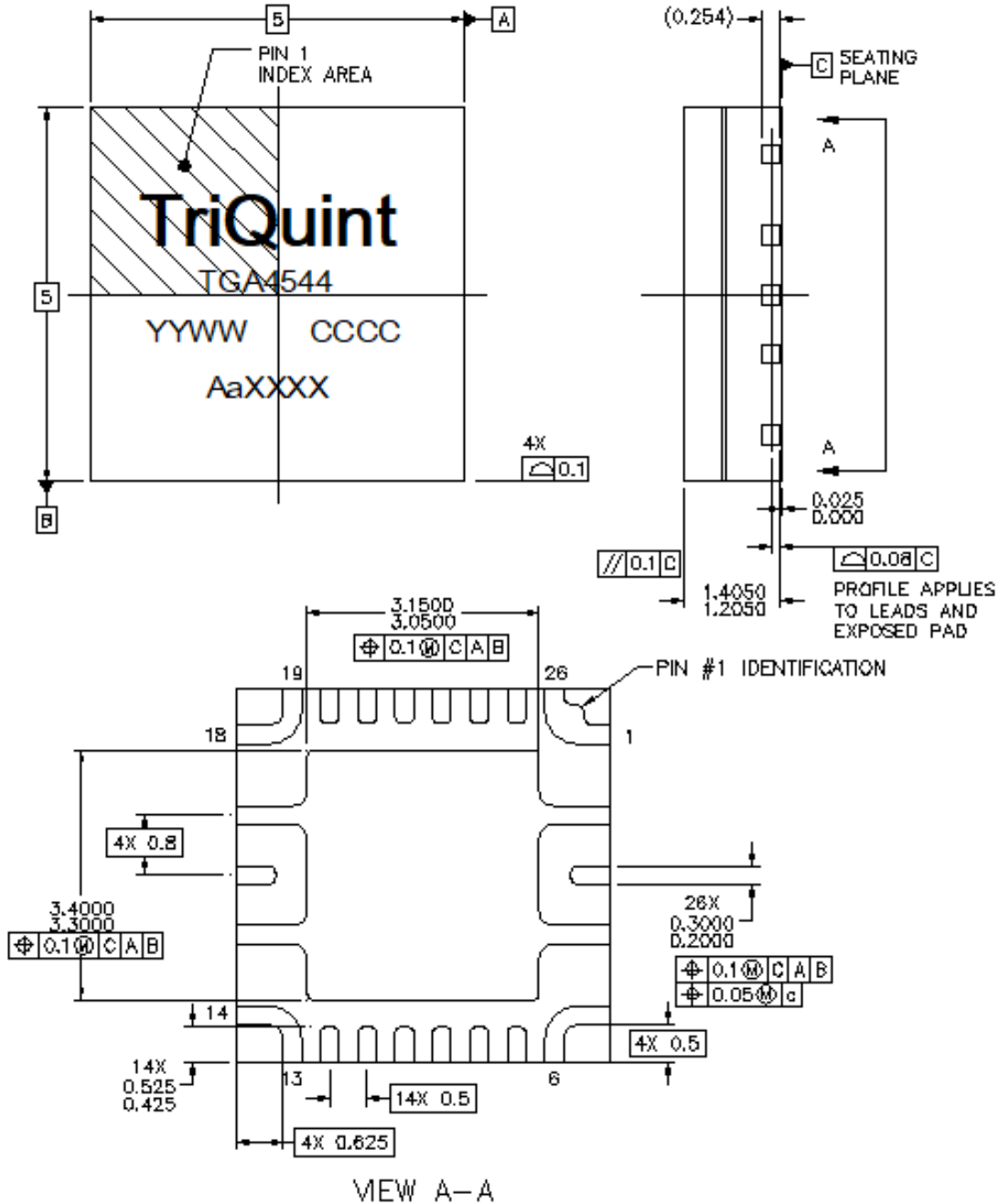

The TGA4544-SM will be marked with the “YYWW” designator and a lot code marked below the part designator. The “YY” represents the last two digits of the year the part was manufactured, the “WW” is the work week, the “CCCC” is the country code, the “Aa” is the vendor, and the “XXXX” is the last 4 digit of lot number.

This package is lead-free/RoHS-compliant with a copper alloy base (CDA194), and the plating material on the leads is NiPdAu. It is compatible with lead-free (maximum 260 °C reflow temperature) soldering process.

PCB Mounting Pattern

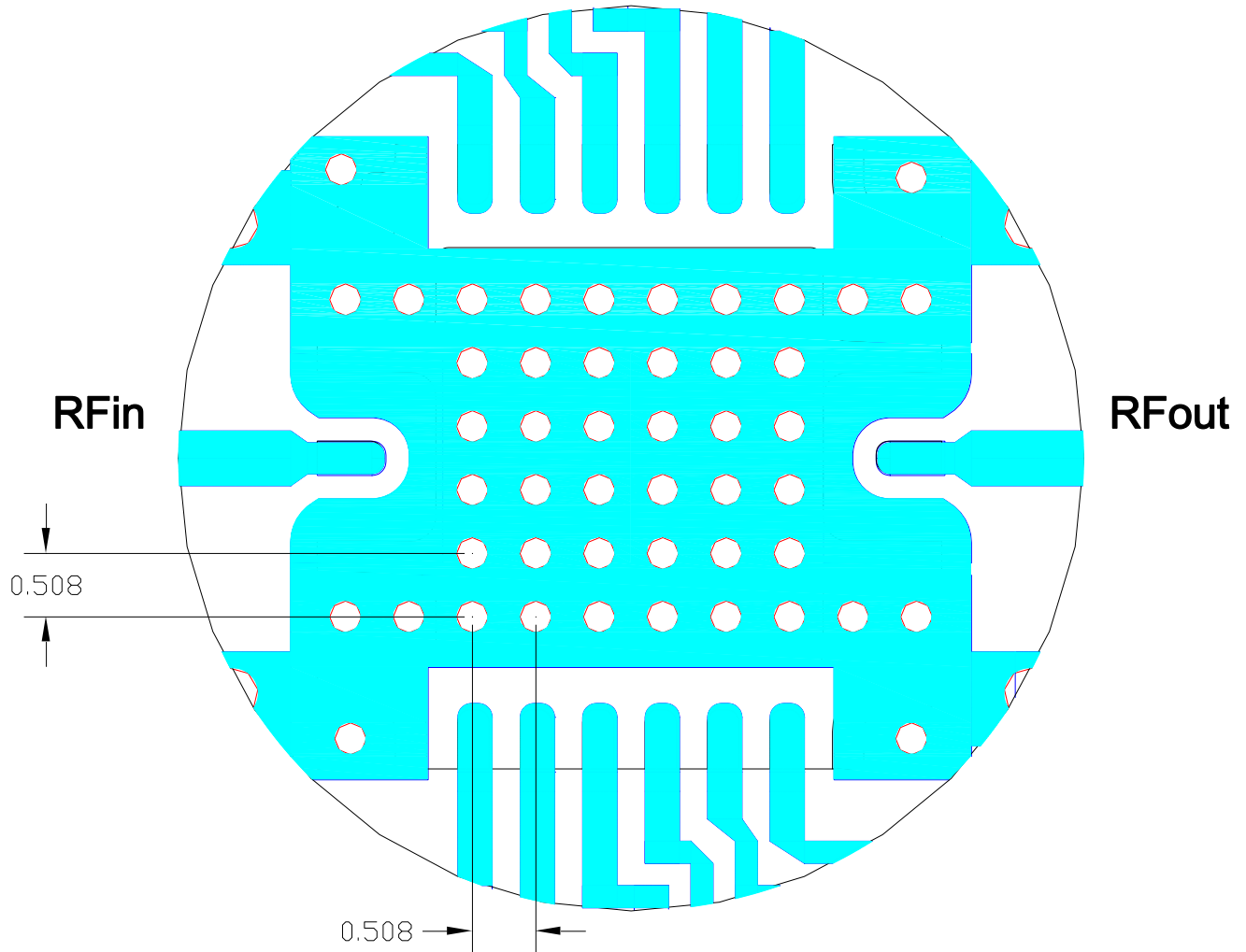

Notes:

1. The pad pattern shown has been developed and tested for optimized assembly at TriQuint Semiconductor. The PCB land pattern has been developed to accommodate lead and package tolerances. Since surface mount processes vary from company to company, careful process development is recommended.
2. Ground vias are critical for the proper performance of this device. Vias have a final plated thru diameter of .25 mm (.010”).

Tape and Reel

Standard T/R size = 200 pieces on a 7" reel
Vendor: Tek-Pak P/N QFN0500x0500F-L500

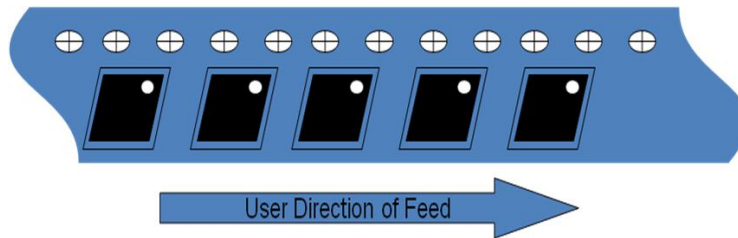

CARRIER AND COVER TAPE DIMENSIONS

Part	Feature	Symbol	Size (in)	Size (mm)
Cavity	Length	A0	0.209	5.3
	Width	B0	0.209	5.3
	Depth	K0	0.064	1.65
	Pitch	P1	0.315	8.00
Cover Tape	Width	C	0.362	9.2
Carrier Tape	Width	W	0.472	12.00

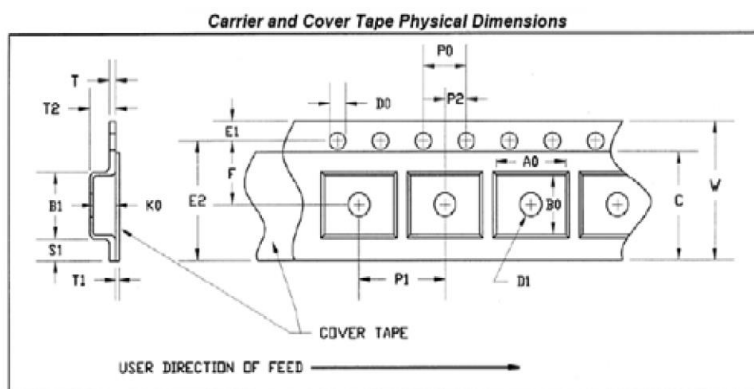

Assembly Notes

Compatible with lead-free soldering processes with 260°C peak reflow temperature.

This package is air-cavity and non-hermetic, and therefore cannot be subjected to aqueous washing. The use of no-clean solder to avoid washing after soldering is highly recommended.

Contact plating: NiPdAu

Solder rework not recommended

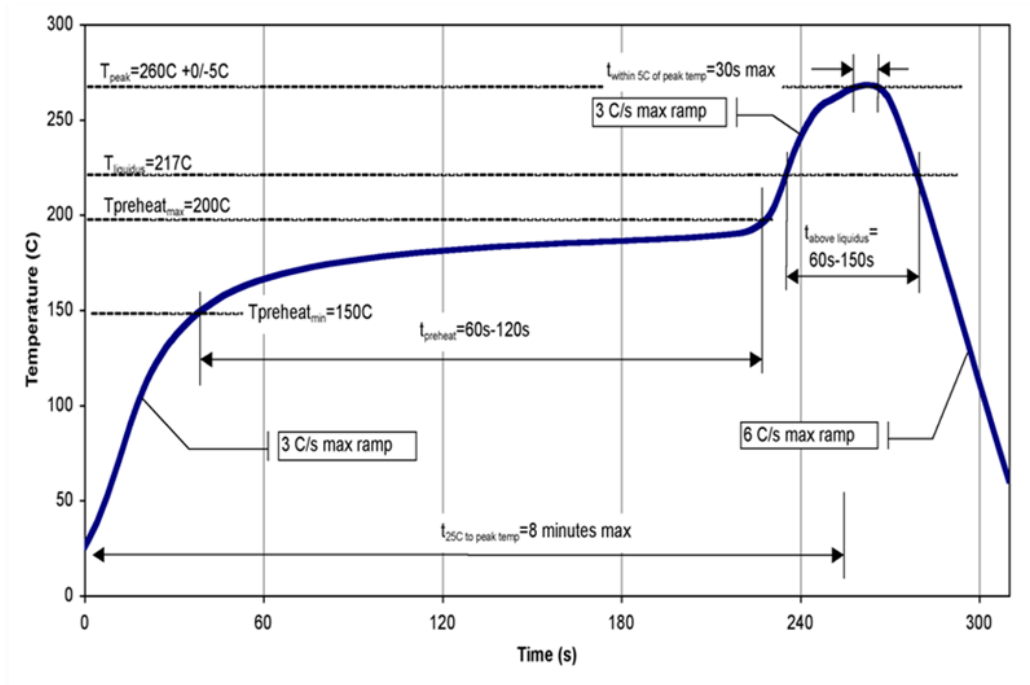

Handling Precautions

Parameter	Rating	Standard
ESD – Human Body Model (HBM)	1A	ESDA / JEDEC JS-001-2012
MSL – Convection Reflow 260 °C	3	JEDEC standard IPC/JEDEC J-STD-020



Caution!
 ESD-Sensitive Device

RoHS Compliance

This product is compliant with the 2011/65/EU RoHS directive (Restrictions on the Use of Certain Hazardous Substances in Electrical and Electronic Equipment), as amended by Directive 2015/863/EU. This product also has the following attributes:

- Lead Free
- Halogen Free (Chlorine, Bromine)
- Antimony Free
- TBBP-A (C₁₅H₁₂Br₄O₂) Free
- SVHC Free

Contact Information

For the latest specifications, additional product information, worldwide sales and distribution locations:

Tel: 1-844-890-8163

Web: www.qorvo.com

Email: customer.support@qorvo.com

Important Notice

The information contained herein is believed to be reliable; however, Qorvo makes no warranties regarding the information contained herein and assumes no responsibility or liability whatsoever for the use of the information contained herein. All information contained herein is subject to change without notice. Customers should obtain and verify the latest relevant information before placing orders for Qorvo products. The information contained herein or any use of such information does not grant, explicitly or implicitly, to any party any patent rights, licenses, or any other intellectual property rights, whether with regard to such information itself or anything described by such information. **THIS INFORMATION DOES NOT CONSTITUTE A WARRANTY WITH RESPECT TO THE PRODUCTS DESCRIBED HEREIN, AND QORVO HEREBY DISCLAIMS ANY AND ALL WARRANTIES WITH RESPECT TO SUCH PRODUCTS WHETHER EXPRESS OR IMPLIED BY LAW, COURSE OF DEALING, COURSE OF PERFORMANCE, USAGE OF TRADE OR OTHERWISE, INCLUDING THE IMPLIED WARRANTIES OF MERCHANTABILITY AND FITNESS FOR A PARTICULAR PURPOSE.**

Without limiting the generality of the foregoing, Qorvo products are not warranted or authorized for use as critical components in medical, life-saving, or life-sustaining applications, or other applications where a failure would reasonably be expected to cause severe personal injury or death.

Copyright 2020 © Qorvo, Inc. | Qorvo is a registered trademark of Qorvo, Inc.

Mouser Electronics

Authorized Distributor

Click to View Pricing, Inventory, Delivery & Lifecycle Information:

[Qorvo:](#)

[TGA4544-SM Waffle Pack](#) [TGA4544-SM T/R](#) [TGA4544-SM](#)