

Product Description

Qorvo's TGA2599-SM is a packaged driver amplifier fabricated on Qorvo's QGaN25 0.25um GaN on SiC production process. The TGA2599-SM operates from 5.0 to 8.0GHz and provides 33 dBm of output power with 15 dB of large signal gain and 34 % power-added efficiency.

Using GaN MMIC technology and plastic packaging, the TGA2599-SM provides a low cost driver solution that provides the added benefit of operating on the same voltage rail as the corresponding GaN HPA. It can also serve as the primary amplifier on lower power architectures.

The TGA2599 is offered in a small 4 x 4 mm plastic overmold QFN, fully matched to 50 ohms and includes integrated DC blocking caps on both RF ports allowing for simple system integration.

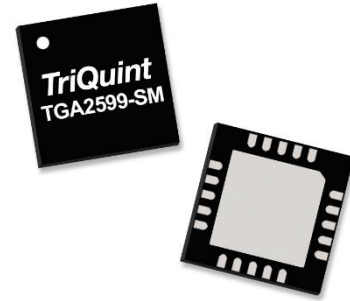

Product Features

- Frequency Range: 5.0-8.0 GHz
- Small Signal Gain: 23 dB
- Saturated Power (CW): 33 dBm
- PAE (CW, @Pin = 18 dBm): 34%
- IM3: -25 dBc @ 26 dBm Pout
- Bias: $V_D = 25\text{ V}$, $I_{DQ} = 50\text{ mA}$
- Package Dimensions: 4.0 x 4.0 x 0.85 mm

Functional Block Diagram

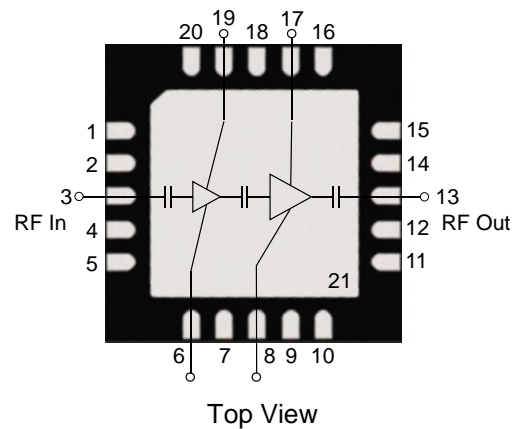

Applications

- Commercial and military radar
- Communications
- Electronic Warfare (EW)

Ordering Information

Part No.	Description
TGA2599-SM	5 – 8 GHz 2W GaN Driver Amplifier
TGA2599-SMEVB01	TGA2599-SM Evaluation Board



Recommended Operating Conditions

Parameter	Min	Typ	Max	Units
Drain Voltage (V_D)		25		V
Drain Current (I_{DQ})		50		mA
Drain Current Under RF Drive (I_{D_DRIVE})		See plots		mA
Gate Voltage (V_G)		-2.5		V
Gate Current Under RF Drive (I_{G_DRIVE})		See plots		mA
Temperature (T_{BASE})	-40		+85	°C

Electrical performance is measured under conditions noted in the electrical specifications table. Specifications are not guaranteed over all recommended operating conditions.

Electrical Specifications

Parameter	Min	Typ	Max	Units
Operational Frequency Range	5		8	GHz
Small Signal Gain		23		dB
Input Return Loss		17		dB
Output Return Loss		5		dB
Output Power (at $P_{in} = 18$ dBm)		33		dBm
Power Added Efficiency (at $P_{in} = 18$ dBm)		34		%

Test conditions unless otherwise noted: $T_{BASE} = +25$ °C, $V_D = +25$ V, $I_{DQ} = 50$ mA, $V_G = -2.5$ V typical, CW Mode
Data de-embedded to reference planes

Absolute Maximum Ratings

Parameter	Range / Value	Units
Drain Voltage (V_D)	40	V
Gate Voltage Range (V_G)	-8 to 0	V
Drain Current (I_{D1})	128	mA
Drain Current (I_{D2})	260	mA
Gate Current (I_{G1}) at $T_{ch} = 200\text{ }^\circ\text{C}$	1.4	mA
Gate Current (I_{G2}) at $T_{ch} = 200\text{ }^\circ\text{C}$	2.8	mA
Power Dissipation (P_{DISS}), $85\text{ }^\circ\text{C}$	5.5	W
Input Power (P_{IN}), CW, $50\ \Omega$	30	dBm
Input Power (P_{IN}), CW, VSWR 10:1	25	dBm
Mounting Temperature (30 Seconds)	260	$^\circ\text{C}$
Storage Temperature	-55 to 150	$^\circ\text{C}$

Operation of this device outside the parameter ranges given above may cause permanent damage. These are stress ratings only, and functional operation of the device at these conditions is not implied. Extended application of Absolute Maximum Rating conditions to the device may reduce device reliability.

Thermal and Reliability Information

Parameter	Values	Units	Conditions
Under Drive, Thermal Resistance (θ_{JC}) ^(1,2,3)	16.3	$^\circ\text{C/W}$	$T_{BASE} = 85\text{ }^\circ\text{C}$, $V_D = +25\text{ V}$, CW Freq = 8 GHz, $I_{D_DRIVE} = 250\text{ mA}$ $P_{IN} = +18\text{ dBm}$, $P_{OUT} = +33\text{ dBm}$, $P_{DISS} = 4.2\text{ W}$
Channel Temperature (T_{CH})	153.48	$^\circ\text{C}$	

Notes:

1. Thermal resistance is measured to package backside
2. Base or ambient temperature is $85\text{ }^\circ\text{C}$
3. Refer to the following document: [GaN Device Channel Temperature, Thermal Resistance, and Reliability Estimates](#)

Performance Plots – Small Signal

Test conditions unless otherwise specified: $V_D = 25\text{ V}$, $I_{DQ} = 50\text{ mA}$, $V_G = -2.5\text{ V}$ Typical, CW, $25\text{ }^\circ\text{C}$

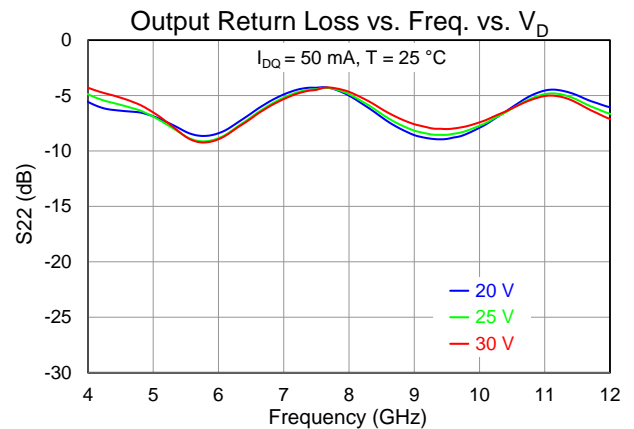
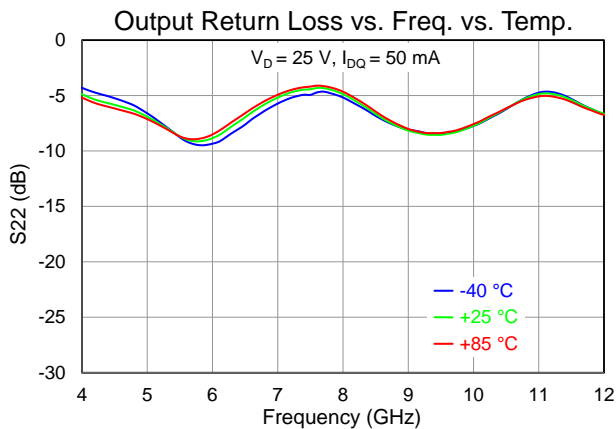
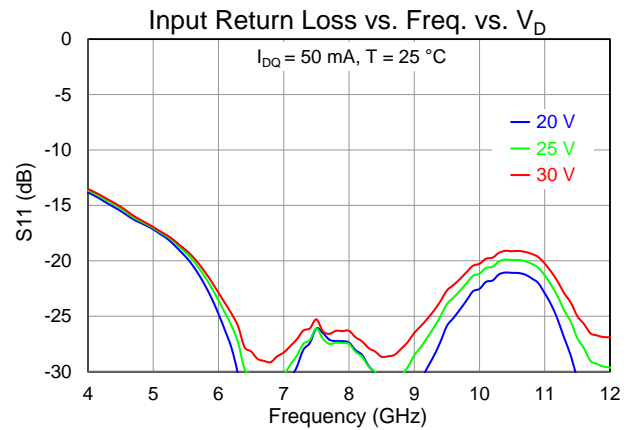
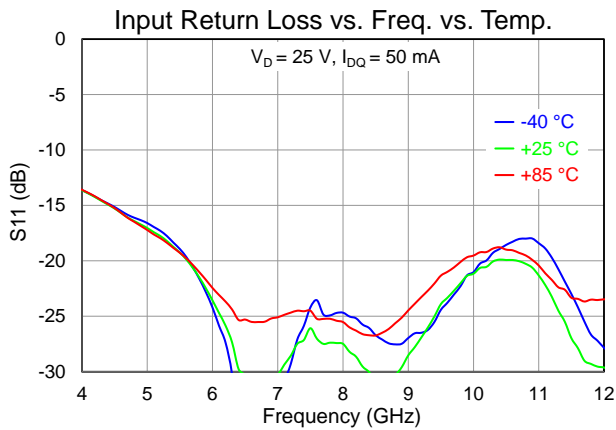
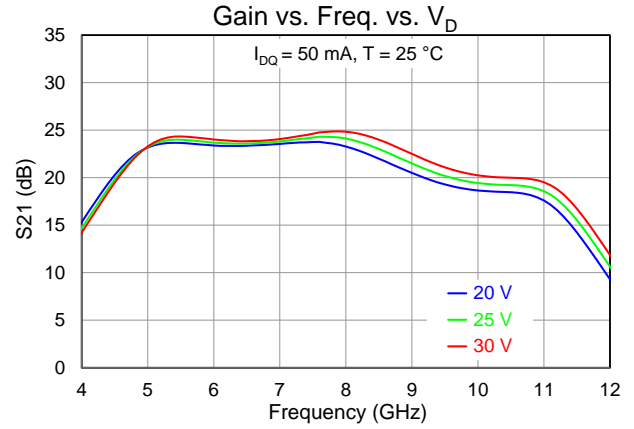
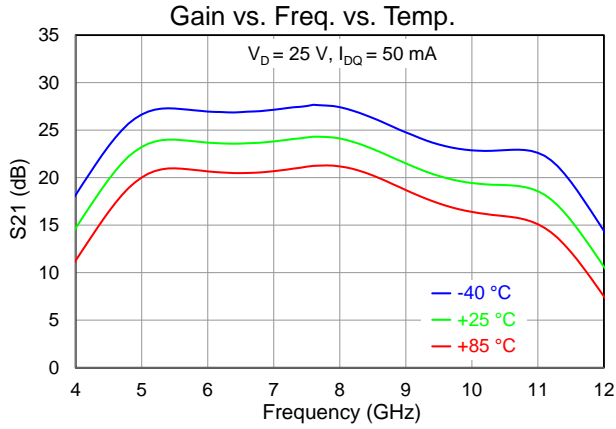

Performance Plots – Small Signal

Test conditions unless otherwise specified: $V_D = 25\text{ V}$, $I_{DQ} = 50\text{ mA}$, $V_G = -2.5\text{ V}$ Typical, CW, $25\text{ }^\circ\text{C}$

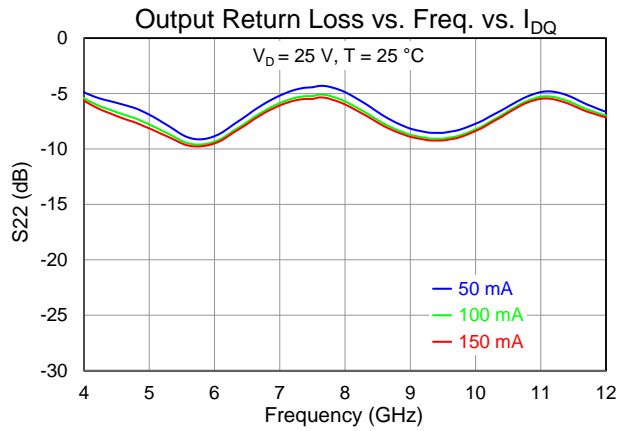
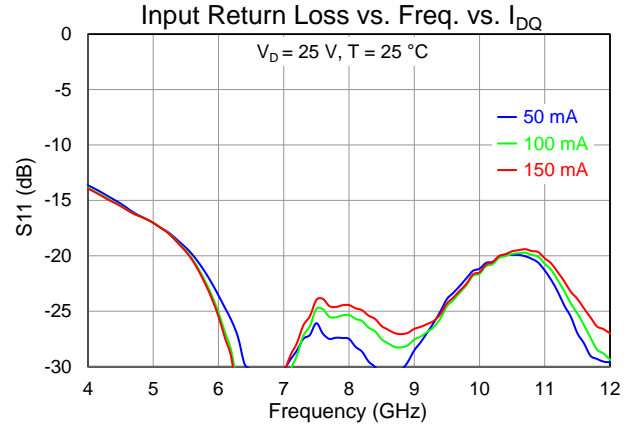
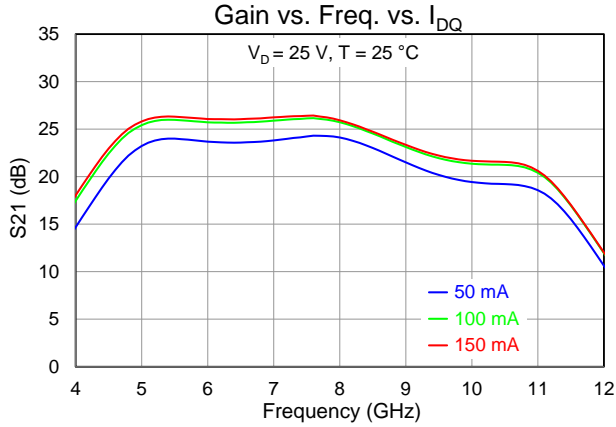

Performance Plots – Large Signal

Test conditions unless otherwise specified: $V_D = 25\text{ V}$, $I_{DQ} = 50\text{ mA}$, $V_G = -2.5\text{ V}$ Typical, CW, $25\text{ }^\circ\text{C}$

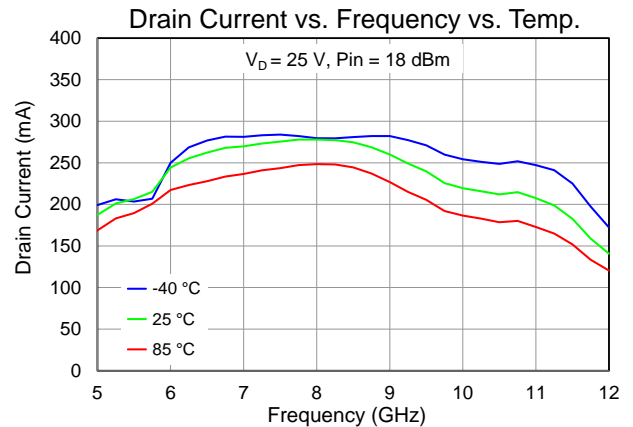
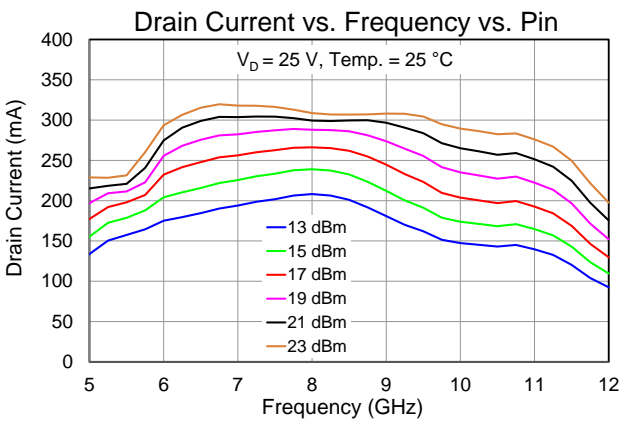
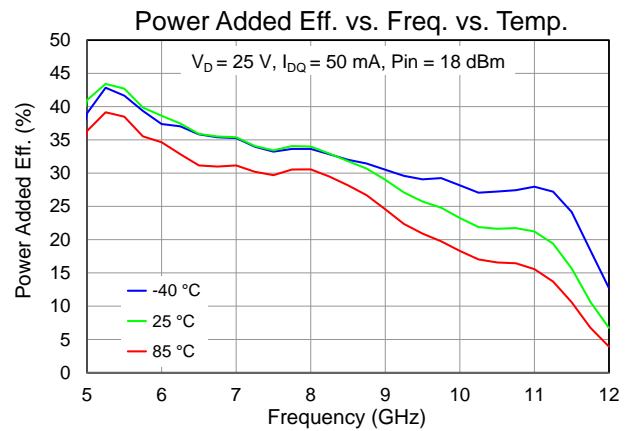
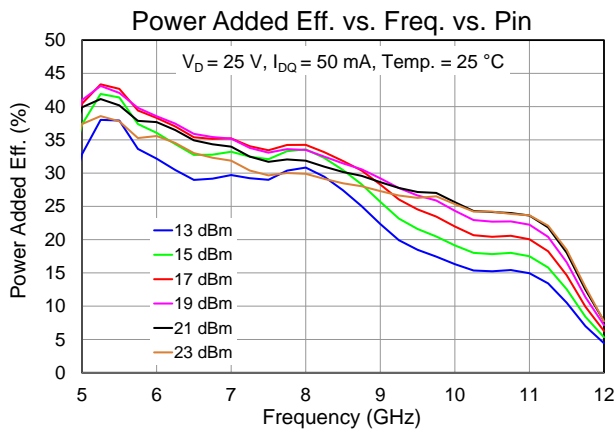
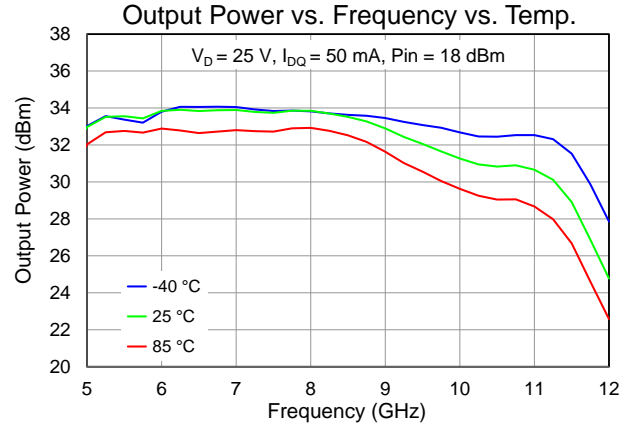
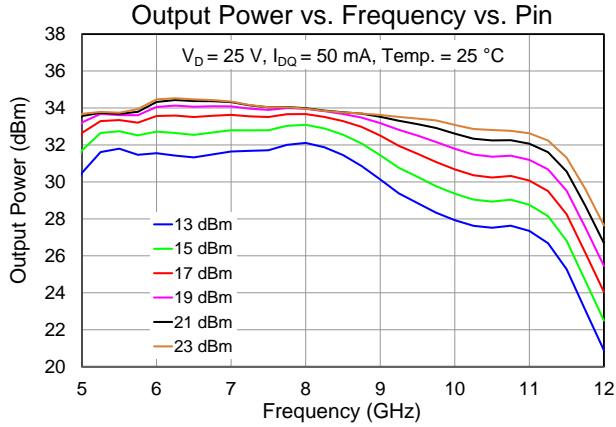

Performance Plots – Large Signal

Test conditions unless otherwise specified: $V_D = 25\text{ V}$, $I_{DQ} = 50\text{ mA}$, $V_G = -2.5\text{ V}$ Typical, CW, $25\text{ }^\circ\text{C}$

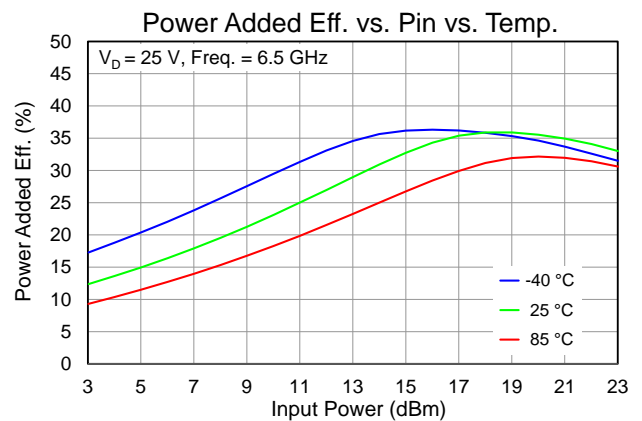
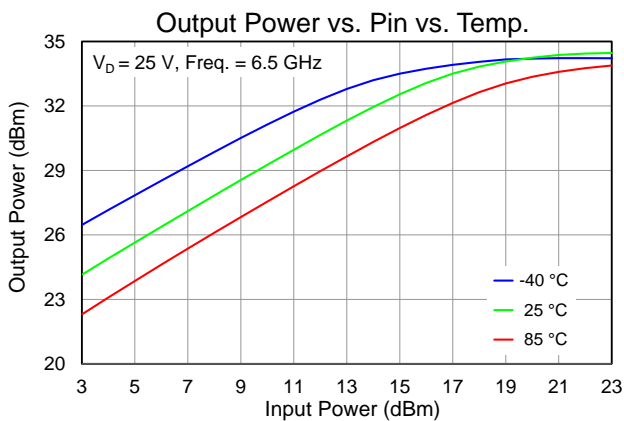
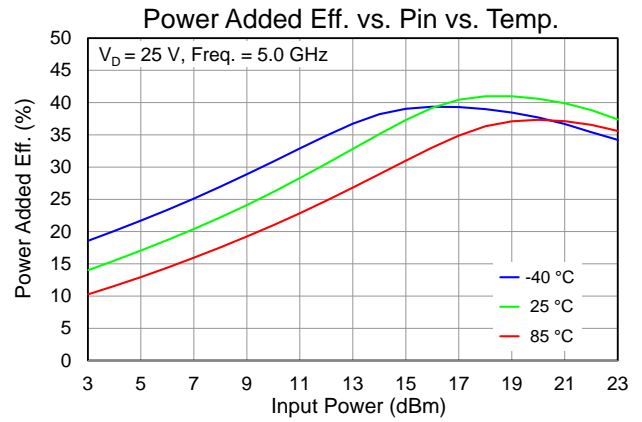
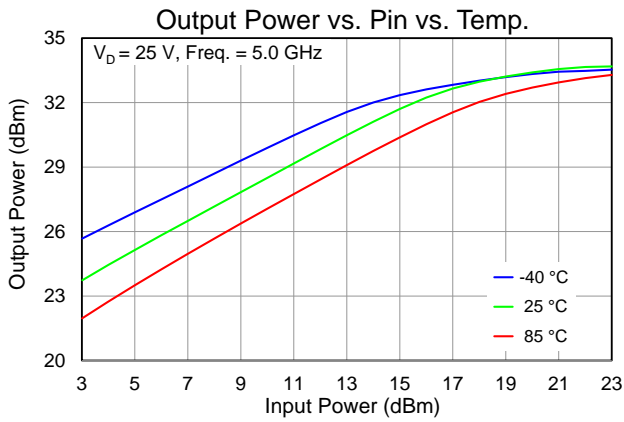
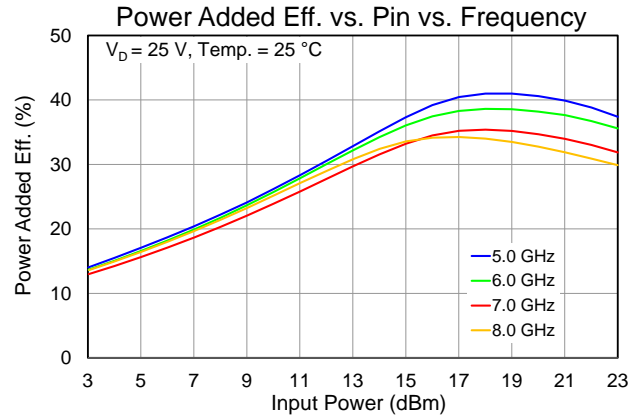
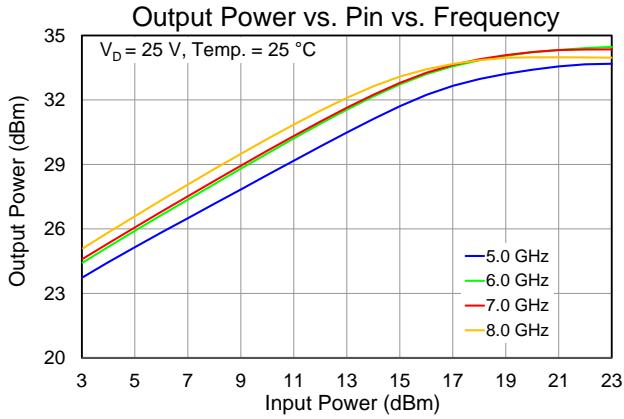

Performance Plots – Large Signals

Test conditions unless otherwise specified: $V_D = 25\text{ V}$, $I_{DQ} = 50\text{ mA}$, $V_G = -2.5\text{ V}$ Typical, CW, $25\text{ }^\circ\text{C}$

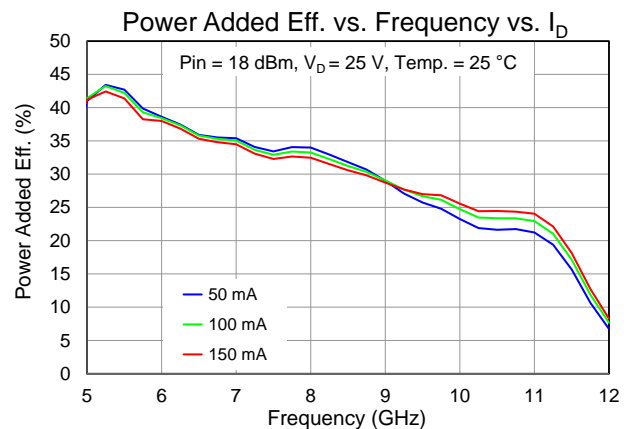
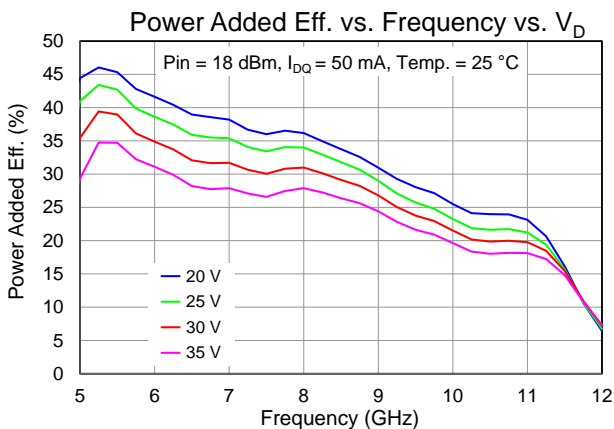
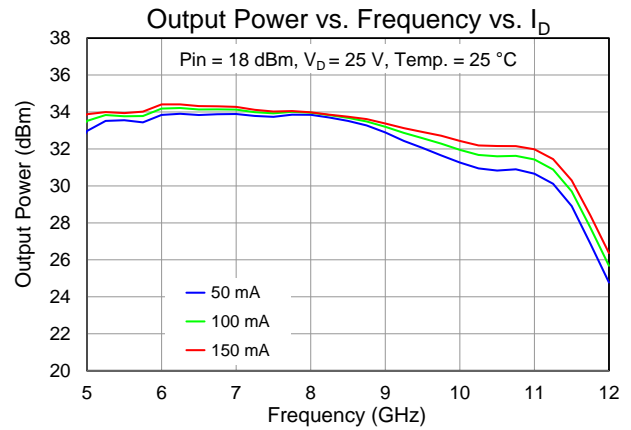
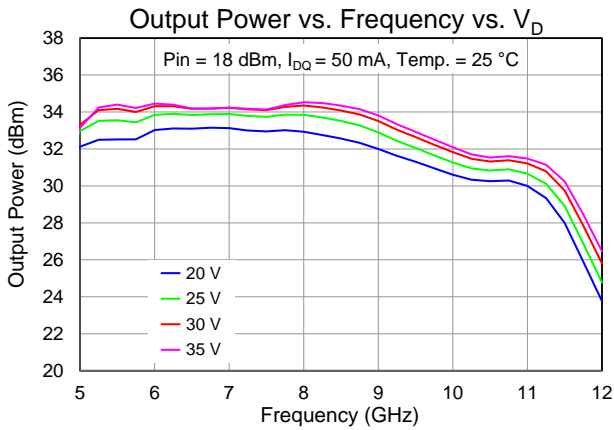
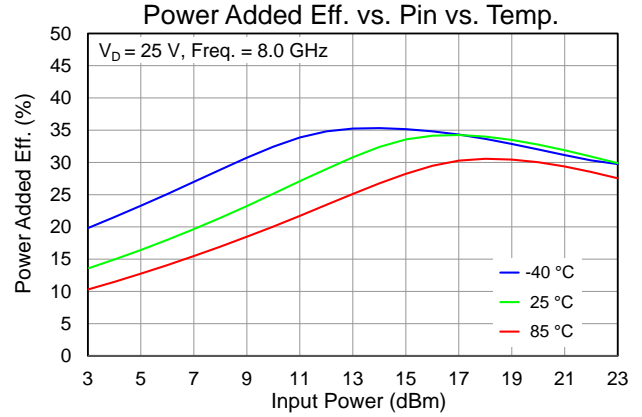
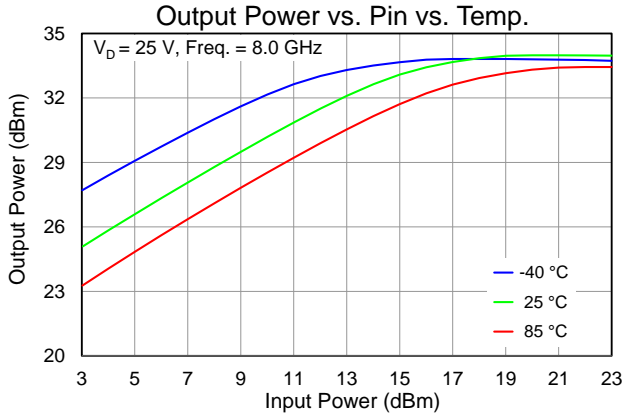

Performance Plots – Linearity and Harmonics

Test conditions unless otherwise specified: $V_D = 25\text{ V}$, $I_{DQ} = 50\text{ mA}$, $V_G = -2.5\text{ V}$ Typical, CW, $25\text{ }^\circ\text{C}$

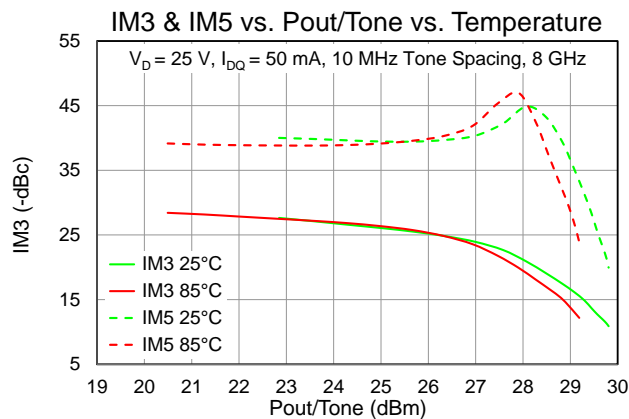
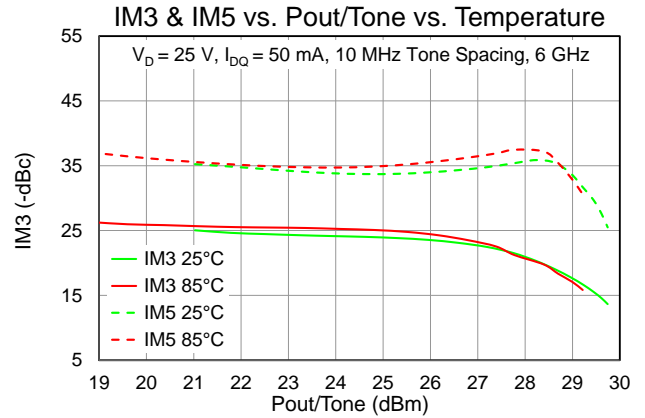
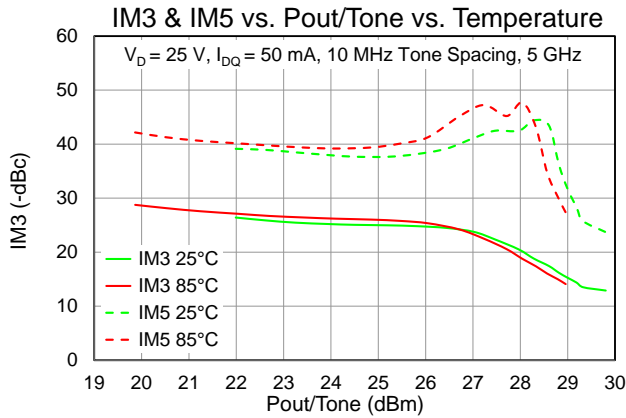
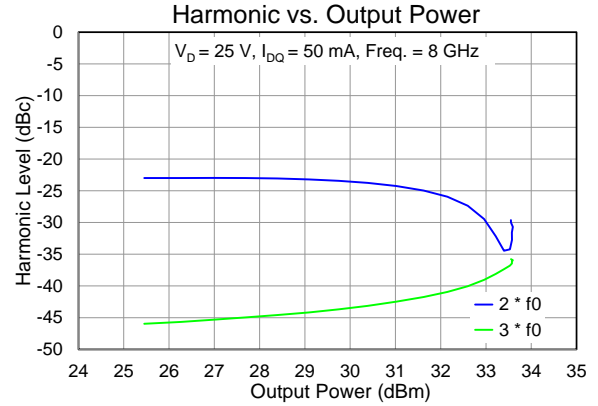
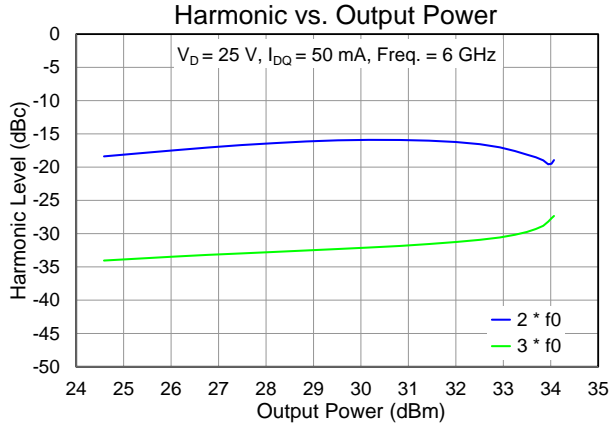

Application Circuit

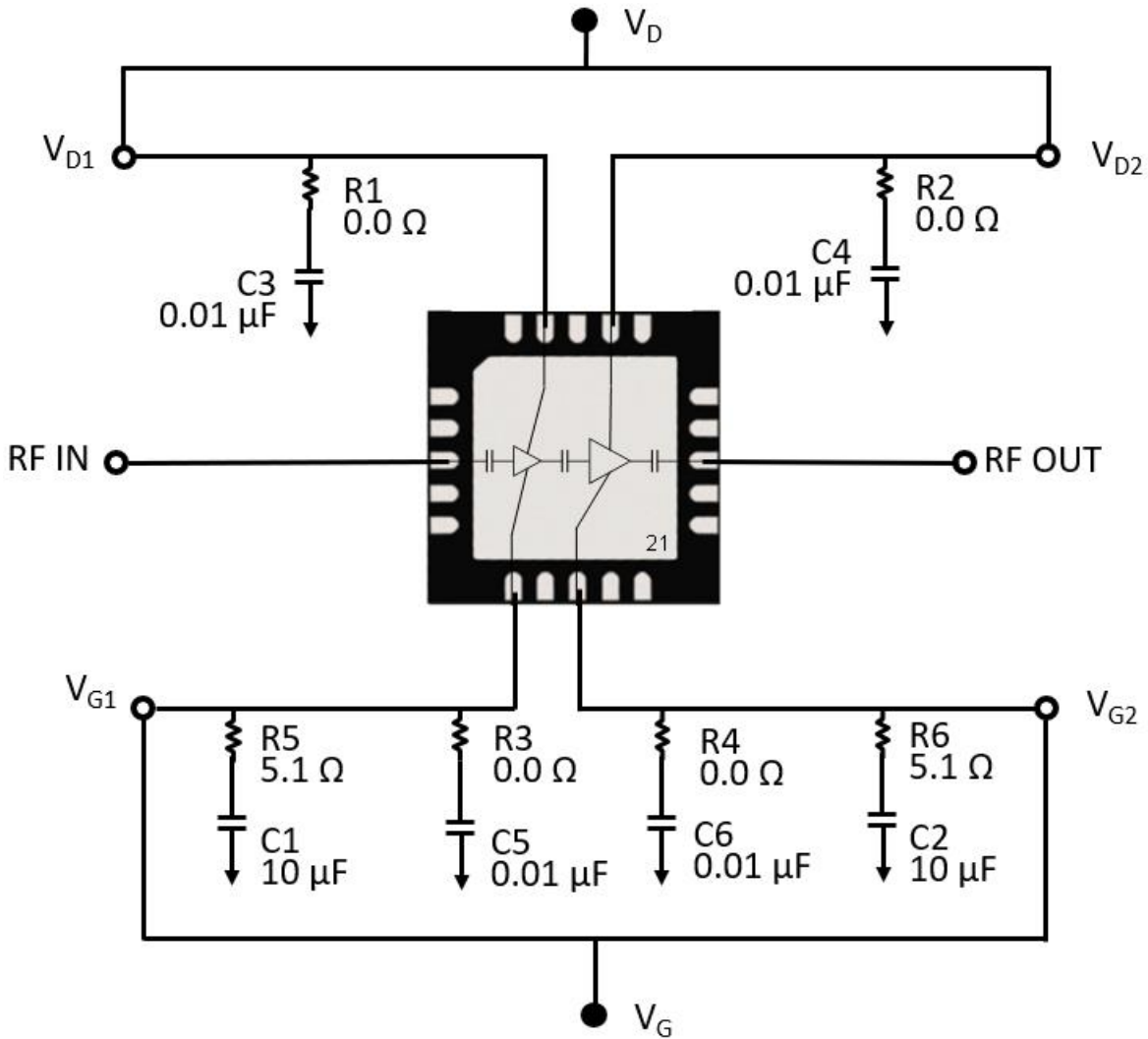

Note: Device shown is top view, V_{D1} / V_{D2} , and V_{G1} / V_{G2} can be gied together

Bias Up Procedure

1. Set I_D limit to 400 mA, I_G limit to 4.5 mA
2. Set V_{G1}/V_{G2} to -5.0V
3. Set V_{D1}/V_{D2} +25V
4. Adjust V_{G1}/V_{G2} more positive until $I_{DQ} = 50$ mA
5. Apply RF signal

Bias Down Procedure

1. Turn off RF signal
2. Set V_{G1}/V_{G2} to -5.0V. Ensure $I_{DQ} \sim 0$ mA
3. Set V_{D1}/V_{D2} to 0V
4. Turn off V_{D1}/V_{D2} supply
5. Turn off V_{G1}/V_{G2} supply

EVB and BOM

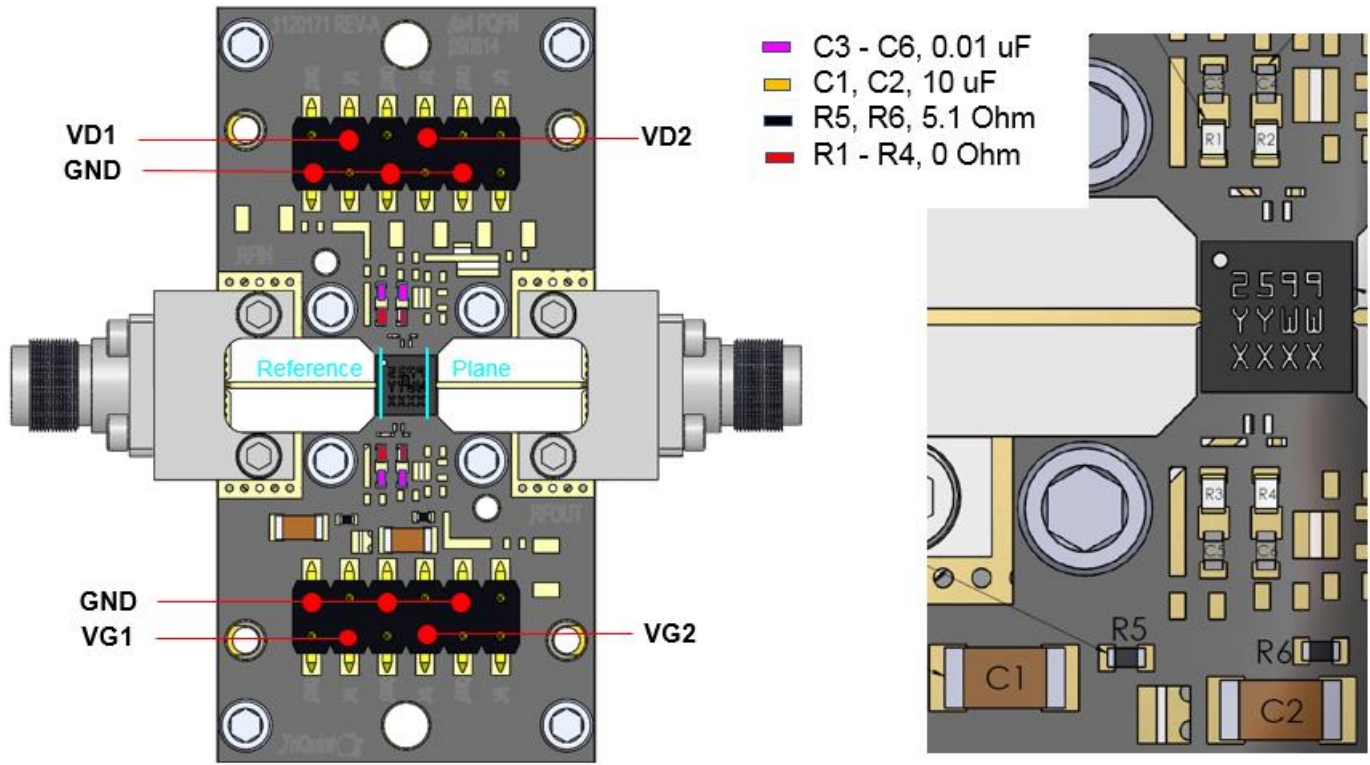

RF Layer is 0.008" thick Rogers Corp. RO4003C, $\epsilon_r = 3.38$. Metal layers are 0.5 oz. copper. The microstrip line at the connector interface is optimized for the Southwest Microwave end launch connector 1092-01A-5.

The trace pattern shown has been developed and tested for optimized assembly at Qorvo Semiconductor. The PCB land pattern has been developed to accommodate lead tolerances. Since processes vary from company to company, careful process development is recommended.

Bill of Materials

Reference Des.	Value	Description	Manuf.	Part Number
C3 – C6	0.01 uF	Cap., 50V, 10% X7R, 0402 case	Various	
C1 - C2	10 uF	Cap., 50V, 10% X5R, 1206 case	Various	
R1 – R4	0.0 Ohms	Resistor, 0402 case	Various	
R5 – R6	5.1 Ohms	Resistor, 0402 case	Various	

Pin Configuration and Description

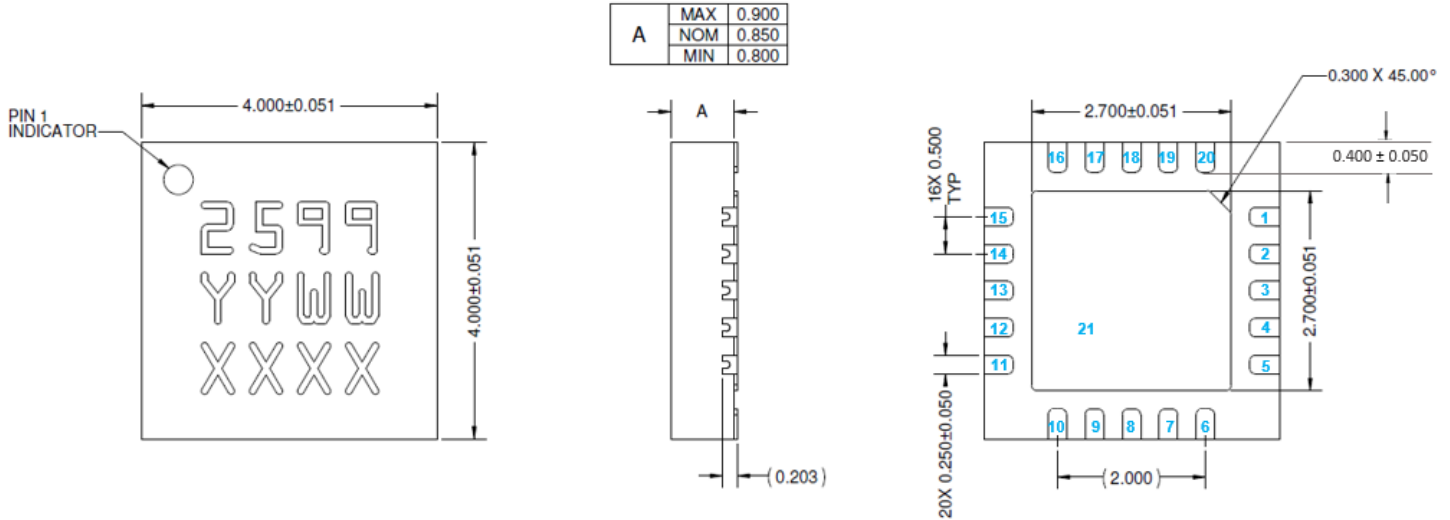

Dimensions in mm. Tolerance unless otherwise stated is +/- 0.127 um.
 Package lead finish: Ni / Au plating with minimum gold thickness of 0.1 um

Materials: Base: Ceramic, Lid: Plastic, Part is epoxy sealed

Part Marking: 2599: Part Number, YY = Part Assembly Year, WW = Part Assembly Week, MXXX = Batch ID

Pin No.	Label	Description
1-2,4-5,7,9-12,14-16,18, 20	GND	Connected to ground paddle (21); must be grounded to PCB to improve isolation.
3	RF Input	RF input, matched to 50 Ω, DC blocked
6	V _{G1}	First stage gate voltage. Bias network required. V _{G1} and V _{G2} can be tied together in application.
8	V _{G2}	Second stage gate voltage. Bias network required. V _{G1} and V _{G2} can be tied together in application.
13	RF Output	RF output, matched to 50 Ω, DC blocked
17	V _{D2}	Second stage drain voltage. Bias network required. V _{D1} and V _{D2} can be tied together in application.
19	V _{D1}	First stage drain voltage. Bias network required. V _{D1} and V _{D2} can be tied together in application.
21	GND	Backside paddle. Multiple vias should be employed to minimize inductance and thermal resistance.

Solderability

1. Compatible with the latest version of J-STD-020, Lead-free solder, 260 °C.
2. The use of no-clean solder to avoid washing after soldering is recommended.

Recommended Soldering Temperature Profile

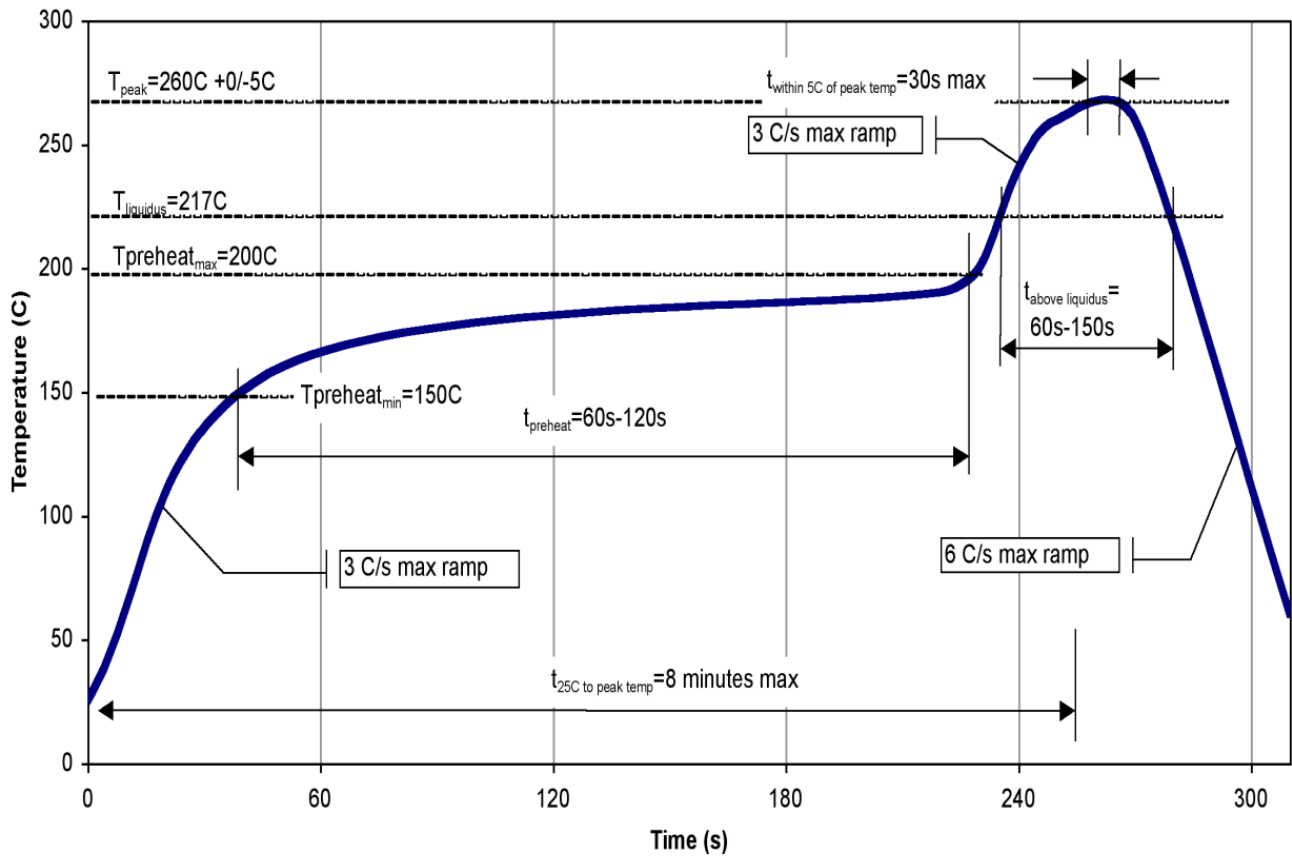

Handling Precautions

Parameter	Rating	Standard
ESD – Human Body Model (HBM)	1A	ESDA / JEDEC JS-001-2012
ESD – Charged Device Model (CDM)	C3	ESDA / JEDEC JS-002-2014
MSL – Convection Reflow 260 °C	3	JEDEC standard IPC/JEDEC J-STD-020



Caution!
ESD-Sensitive Device

RoHS Compliance

This product is compliant with the 2011/65/EU RoHS directive (Restrictions on the Use of Certain Hazardous Substances in Electrical and Electronic Equipment), as amended by Directive 2015/863/EU. This product also has the following attributes:

- Lead Free
- Halogen Free (Chlorine, Bromine)
- Antimony Free
- TBBP-A (C₁₅H₁₂Br₄O₂) Free
- PFOS Free
- SVHC Free



Contact Information

For the latest specifications, additional product information, worldwide sales and distribution locations:

Tel: 1-844-890-8163

Web: www.qorvo.com

Email: customer.support@qorvo.com

For technical questions and application information:

Email: appsupport@qorvo.com

Important Notice

The information contained herein is believed to be reliable; however, Qorvo makes no warranties regarding the information contained herein and assumes no responsibility or liability whatsoever for the use of the information contained herein. All information contained herein is subject to change without notice. Customers should obtain and verify the latest relevant information before placing orders for Qorvo products. The information contained herein or any use of such information does not grant, explicitly or implicitly, to any party any patent rights, licenses, or any other intellectual property rights, whether with regard to such information itself or anything described by such information. **THIS INFORMATION DOES NOT CONSTITUTE A WARRANTY WITH RESPECT TO THE PRODUCTS DESCRIBED HEREIN, AND QORVO HEREBY DISCLAIMS ANY AND ALL WARRANTIES WITH RESPECT TO SUCH PRODUCTS WHETHER EXPRESS OR IMPLIED BY LAW, COURSE OF DEALING, COURSE OF PERFORMANCE, USAGE OF TRADE OR OTHERWISE, INCLUDING THE IMPLIED WARRANTIES OF MERCHANTABILITY AND FITNESS FOR A PARTICULAR PURPOSE.**

Without limiting the generality of the foregoing, Qorvo products are not warranted or authorized for use as critical components in medical, life-saving, or life-sustaining applications, or other applications where a failure would reasonably be expected to cause severe personal injury or death.

Copyright 2019 © Qorvo, Inc. | Qorvo is a registered trademark of Qorvo, Inc.

Mouser Electronics

Authorized Distributor

Click to View Pricing, Inventory, Delivery & Lifecycle Information:

[Qorvo:](#)

[TGA2599-SM](#) [TGA2599-SMTR](#)