

TGA2535-SM

X-Band Power Amplifier

Applications

- Point-to-Point Radio
- X-Band Communications

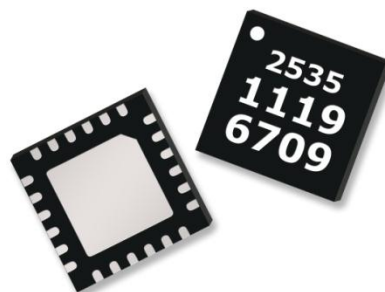

QFN 5x5mm 24L

Product Features

- Frequency Range: 10 – 12 GHz
- TOI: 43 dBm
- Power: 34.5 dBm Psat, 33 dBm P1dB
- Gain: 24 dB
- Return Loss: 15 dB
- Integrated Power Detector
- Bias: $V_d = 6\text{ V}$, $I_d = 1.3\text{ A}$, $V_g = -0.55\text{ V}$ Typical
- Package Dimensions: 5.0 x 5.0 x 0.85 mm

Functional Block Diagram

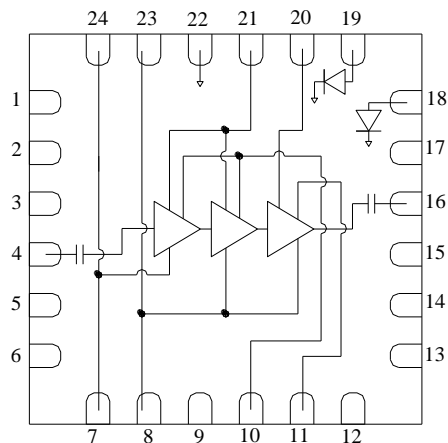

General Description

The TriQuint TGA2535-SM is a X-Band Packaged Power Amplifier. The TGA2535-SM operates from 10 to 12 GHz and is designed using TriQuint's power pHEMT production process.

The TGA2535-SM typically provides 43dBm of TOI at 20dBm Pout/Tone, 33 dBm of output power at 1dB gain compression, and the small signal gain is 24 dB.

The TGA2535-SM is available in a low-cost, surface mount 24 lead 5x5 QFN package and is ideally suited for Point-to-Point Radio, and X-Band Communications.

Lead-free and RoHS compliant

Evaluation Boards are available upon request.

Pin Configuration

Pin #	Symbol
1, 2, 3, 5, 6, 9, 12, 13, 14, 15, 17	N/C
4	RF IN
7, 8, 23, 24	V_g
16	RF OUT
10, 11, 20, 21	V_d
18	V_{ref}
19	V_{det}
22	GND

Ordering Information

Part No.	ECCN	Description
TGA2535-SM	EAR99	X-band Power Amplifier

Standard T/R size = 500 pieces on a 7" reel.

Specifications

Absolute Maximum Ratings

Parameter	Rating
Drain Voltage, Vd	+8 V
Gate Voltage, Vg	-3 to 0 V
Drain Current, Id	2.24 A
Gate Current, Ig	-11 to 90 mA
Power Dissipation, Pdiss	17.9 W
RF Input Power, CW, 50Ω, T = 25°C	27 dBm
Channel Temperature, Tch	200 °C
Mounting Temperature (30 Seconds)	260 °C
Storage Temperature	-40 to 150 °C

Operation of this device outside the parameter ranges given above may cause permanent damage. These are stress ratings only, and functional operation of the device at these conditions is not implied.

Recommended Operating Conditions

Parameter	Min	Typical	Max	Units
Vd		6		V
Id		1.3		A
Id_drive (Under RF Drive)		1.6		A
Vg		-0.55		V

Electrical specifications are measured at specified test conditions. Specifications are not guaranteed over all recommended operating conditions.

Electrical Specifications

Test conditions unless otherwise noted: 25°C, Vd = 6 V, Id = 1.3 A, Vg = -0.55 V Typical.

Parameter	Min	Typical	Max	Units
Operational Frequency Range	10.0		12.0	GHz
Gain	20.5	24		dB
Input Return Loss		-15	-10	dB
Output Return Loss		-15	-12	dB
Output Power @ Saturation	33	34.5		dBm
Output Power @ 1 dB Gain Compression	31.5	33		dBm
Output TOI @ Pout/Tone = 20 dBm	41	43		dBm
Noise Figure		10		dB
Gain Temperature Coefficient		-0.031		dB/°C
Power Temperature Coefficient		-0.004		dBm/°C

Specifications (cont.)

Thermal and Reliability Information

Parameter	Condition	Rating
Thermal Resistance, θ_{JC} , measured to back of package	Tbase = 85 °C	$\theta_{JC} = 5.77$ °C/W
Channel Temperature (Tch), and Median Lifetime (Tm)	Tbase = 85 °C, Vd = 6 V, Id = 1.3 A, Pdiss = 7.8 W	Tch = 130 °C Tm = 5.9 E+6 Hours
Channel Temperature (Tch), and Median Lifetime (Tm) Under RF Drive	Tbase = 85 °C, Vd = 6 V, Id = 1.6 A, Pout = 34.5 dBm, Pdiss = 6.78 W	Tch = 124 °C Tm = 1.0 E+7 Hours

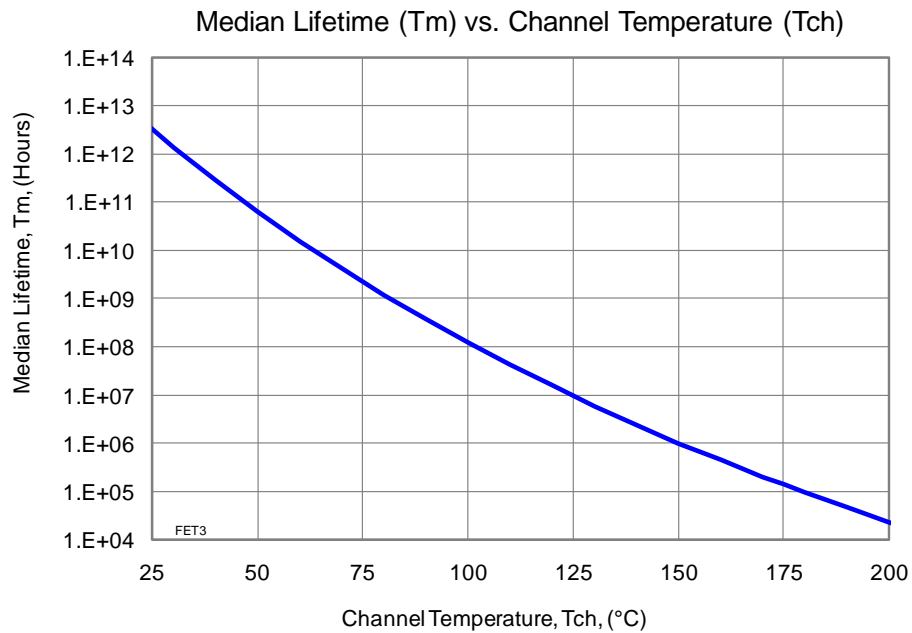

Typical Performance

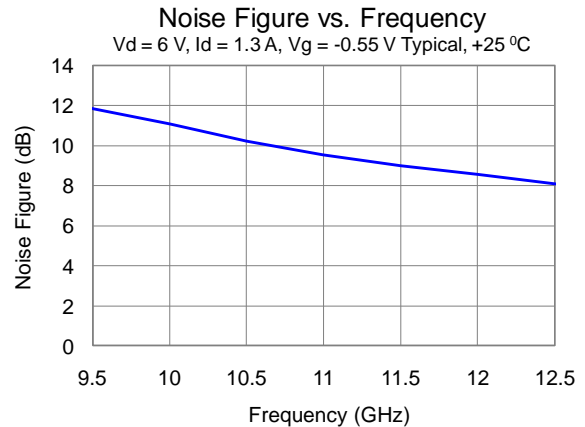
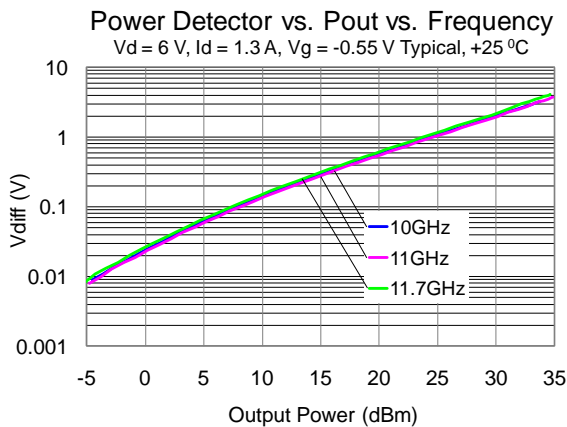
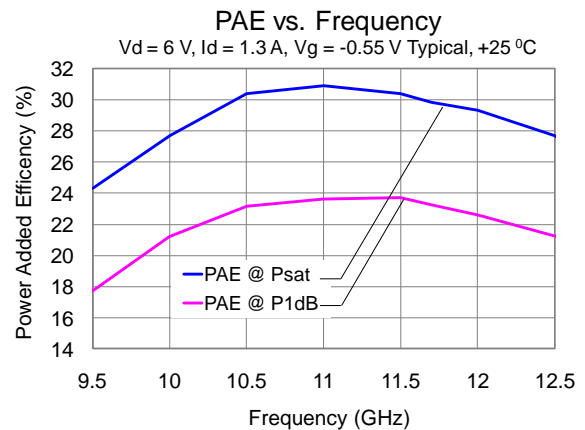
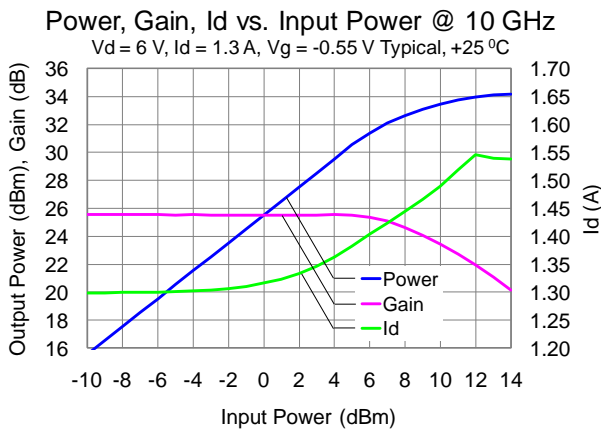
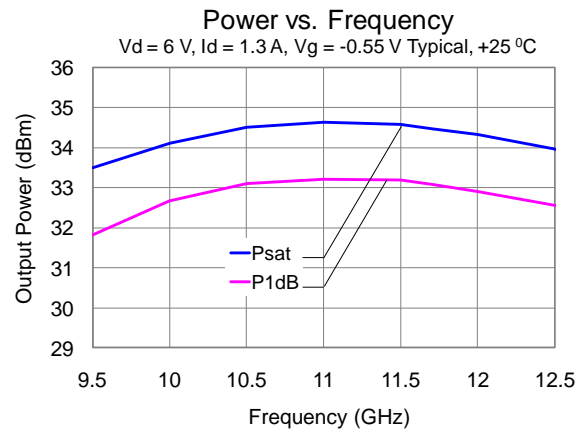
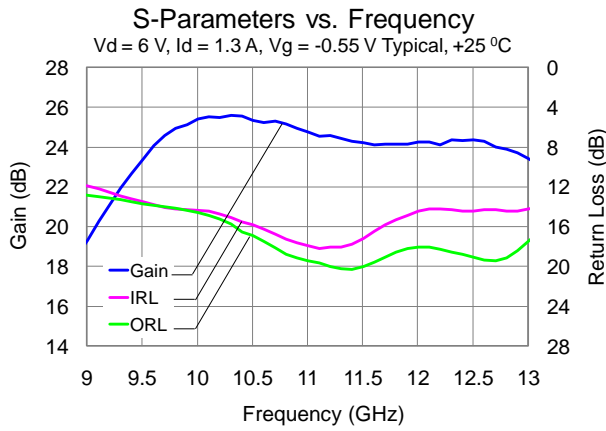

Typical Performance (cont.)

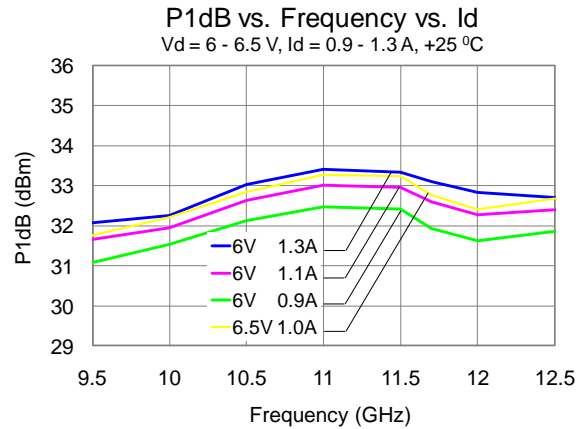
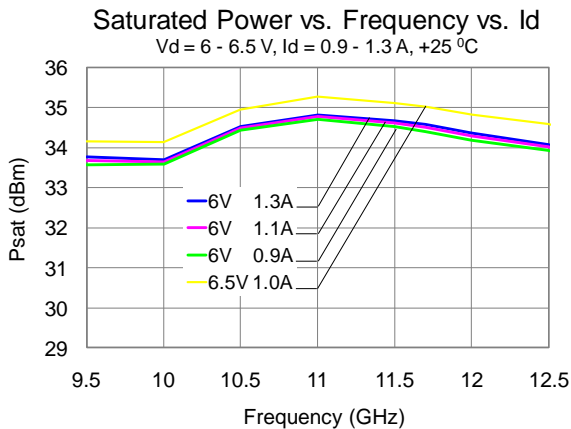
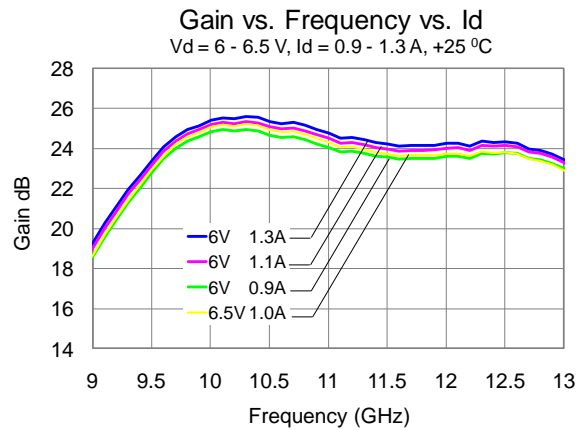
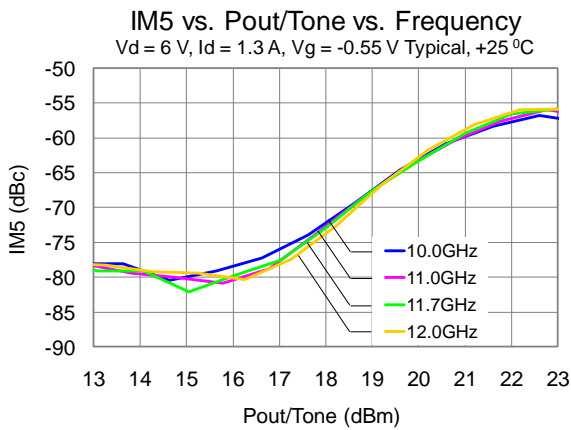
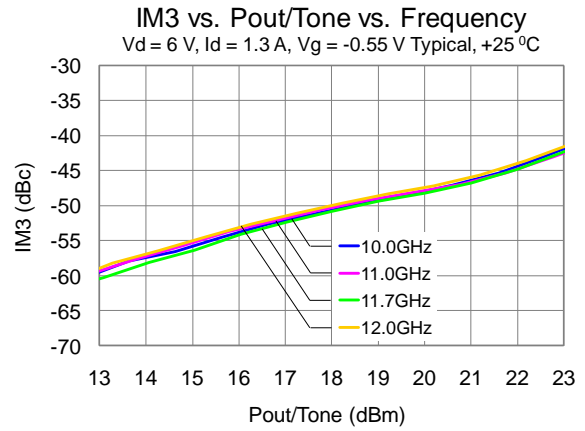
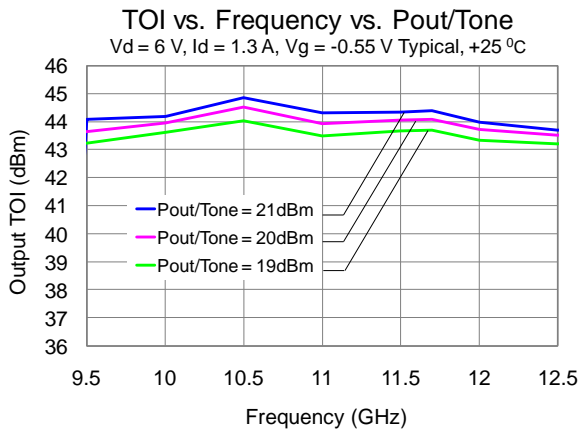

Typical Performance (cont.)

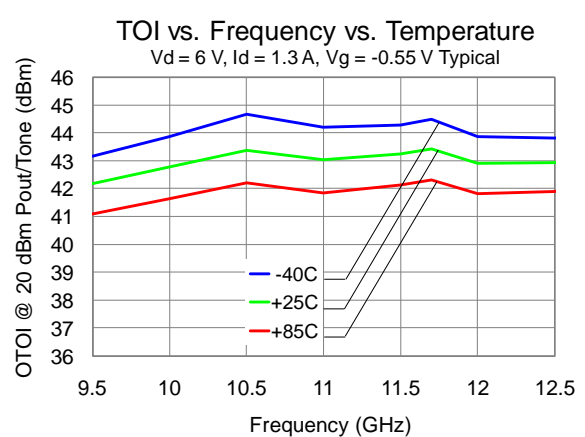
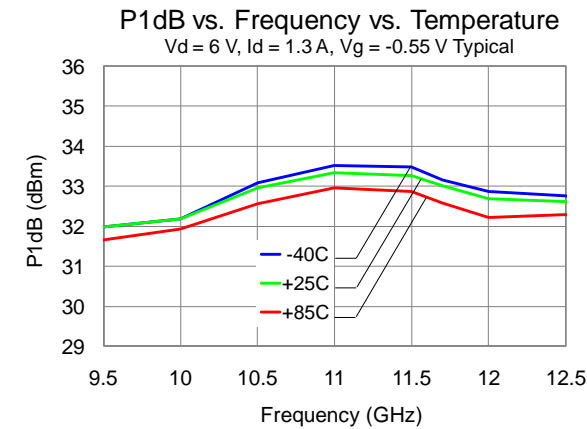
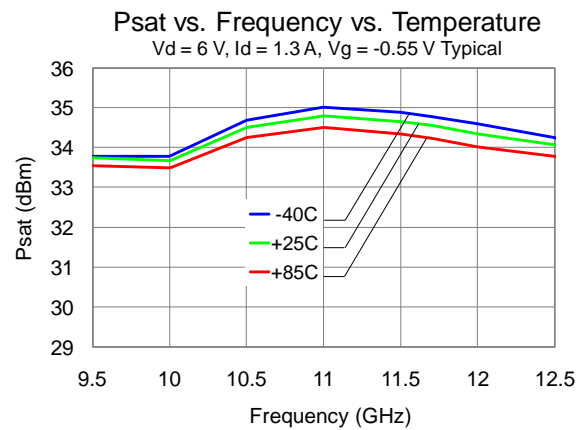
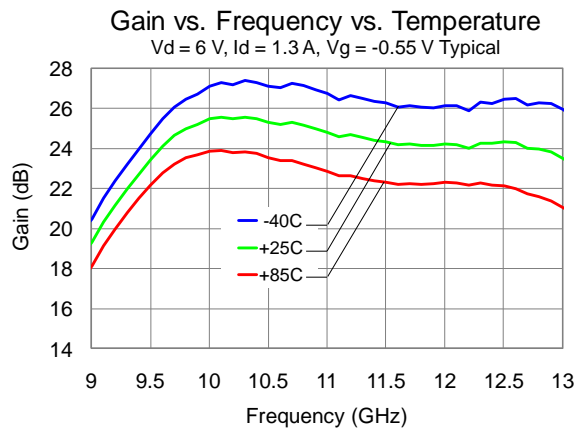
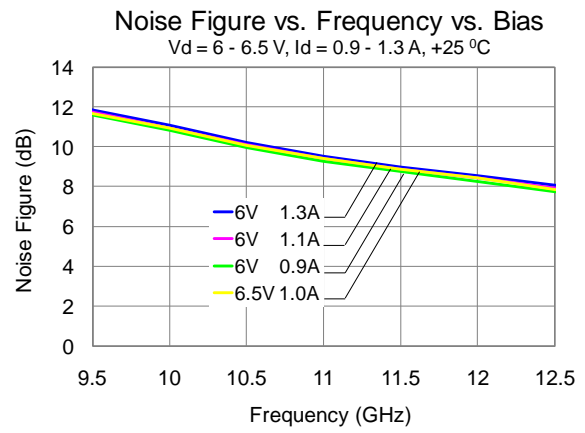
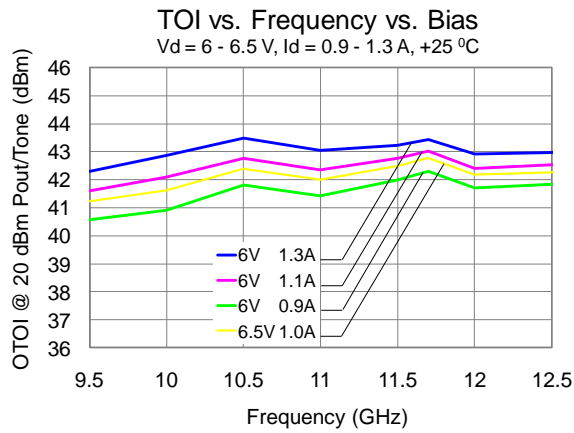

Application Circuit

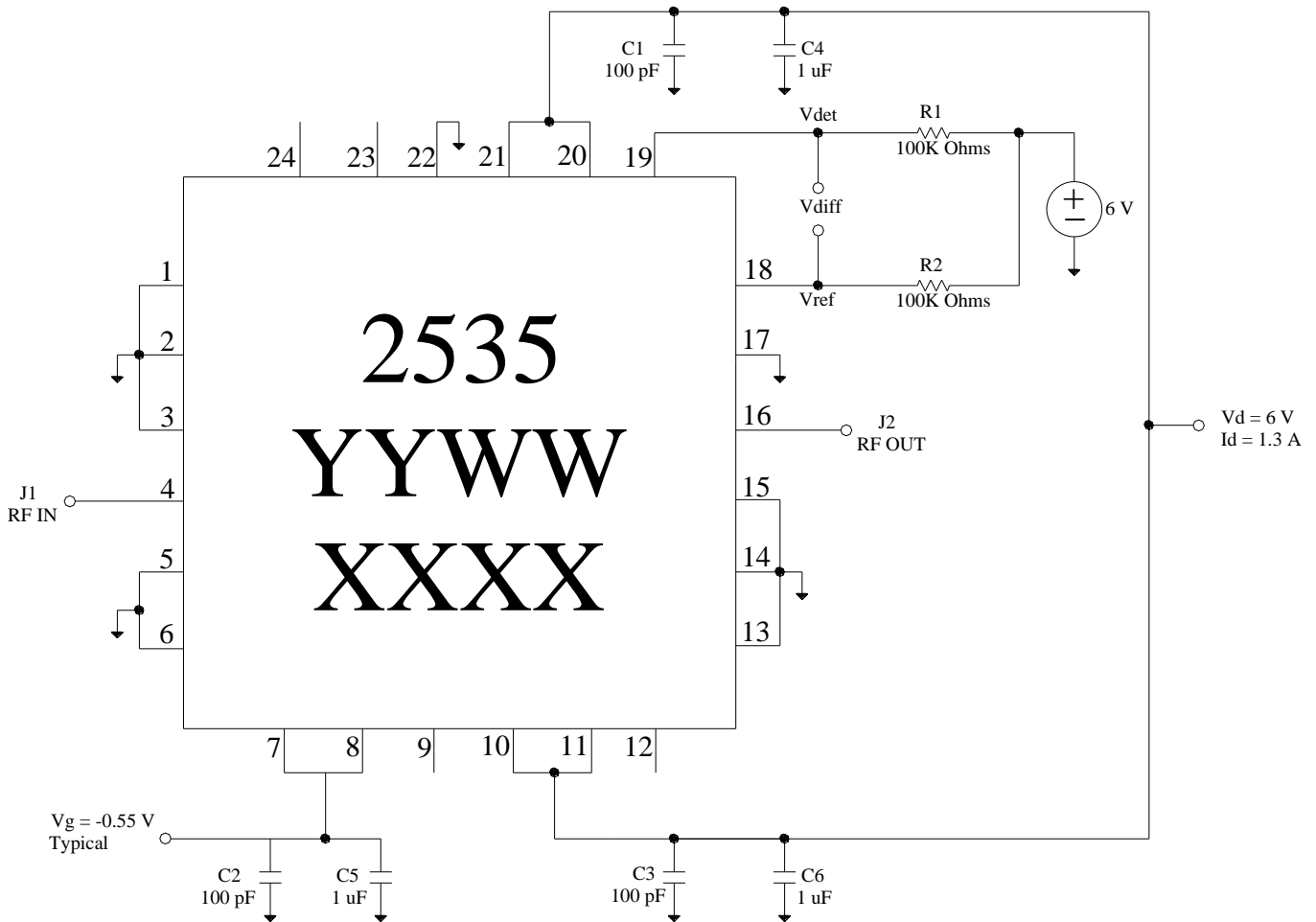

Vg can be biased from either side (pins 7 and 8 or pins 23 and 24), and the non-biased side can be left open.
Vd must be biased from both sides (pins 10, 11, 20, and 21).

Bias-up Procedure

Vg set to -1.5 V
Vd set to +6 V
Adjust Vg more positive until quiescent Id is 1.3A.
This will be ~ Vg = -0.55 V
Apply RF signal to RF Input

Bias-down Procedure

Turn off RF supply
Reduce Vg to -1.5V. Ensure Id ~ 0 mA
Turn Vd to 0 V
Turn Vg to 0 V

The TGA2535-SM will be marked with the “2535” designator and a lot code marked below the part designator. The “YY” represents the last two digits of the year the part was manufactured, the “WW” is the work week, and the “XXXX” is an auto-generated number.

Pin Description

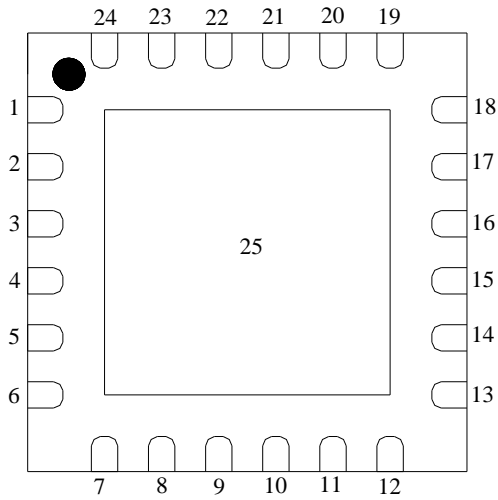

Pin	Symbol	Description
1, 2, 3, 5, 6, 13, 14, 15, 17	N/C	No internal connection; must be grounded on PCB
4	RF IN	Input, matched to 50 ohms
7, 8, 23, 24	V _g	Gate voltage. ESD protection included; Bias network is required; can be biased from either side (pins 7 and 8 or pins 23 and 24), and non-biased side can be left opened; see Application Circuit on page 7 as an example.
9, 12	N/C	No internal connection; can be grounded on PCB or left open
10, 11, 20, 21	V _d	Drain voltage. Bias network is required; must be biased from both sides; see Application Circuit on page 7 as an example.
16	RF OUT	Output, matched to 50 ohms
18	V _{ref}	Reference diode output voltage
19	V _{det}	Detector diode output voltage; varies with RF output power
22	GND	Internal grounding; can be grounded on PCB or left open
25	GND	Backside Paddle. Multiple vias should be employed to minimize inductance and thermal resistance; see Mounting Configuration on page 11 for suggested footprint.

Applications Information

PC Board Layout

Top RF layer is 0.008” thick Rogers RO4003, $\epsilon_r = 3.38$. Metal layers are 1-oz copper. Microstrip 50 Ω line detail: width = 0.0175”.

The pad pattern shown has been developed and tested for optimized assembly at TriQuint Semiconductor. The PCB land pattern has been developed to accommodate lead and package tolerances. Since surface mount processes vary from company to company, careful process development is recommended.

For further technical information, refer to the [TGA2533-SM](#) Product Information page.

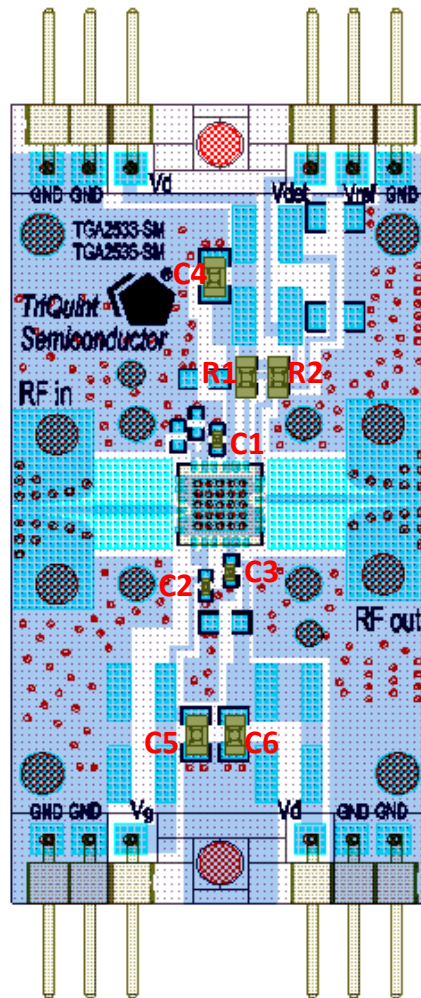

Bill of Material

Ref Des	Value	Description	Manufacturer	Part Number
C1, C2, C3	100 pF	Cap, 0402, 50 V, 5%, COG	various	
C4, C5, C6	1 uF	Cap, 0603, 25 V, 10%, X5R	various	
R1, R2	100K Ohms	Res, 0603, 0.1 W, 5%, SMD	various	

Mechanical Information

Package Information and Dimensions

All dimensions are in millimeters.

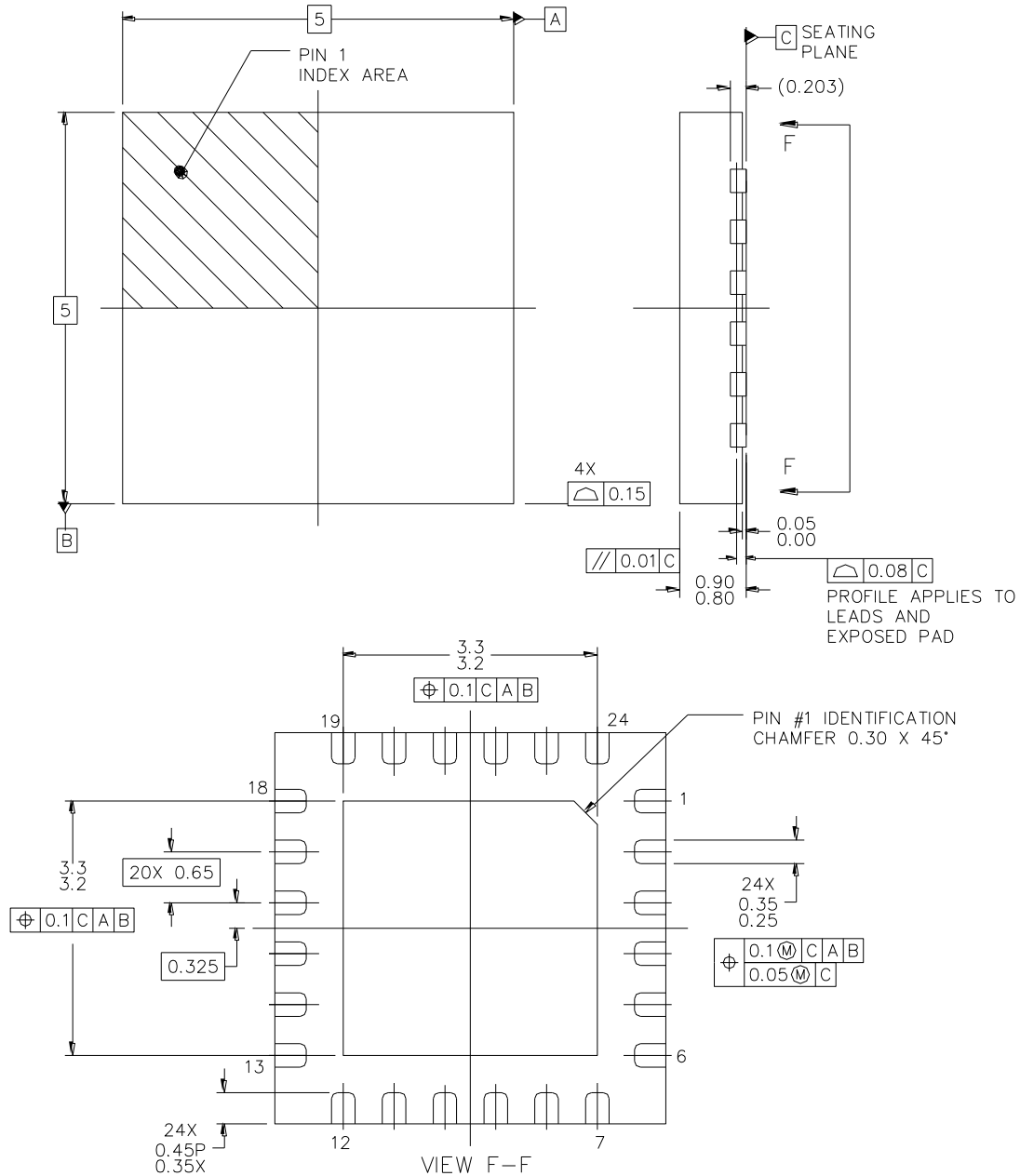

This package is lead-free/RoHS-compliant with a copper alloy base (CDA194), and the plating material on the leads is 100% matte Sn. It is compatible with both lead-free (maximum 260 °C reflow temperature) and tin-lead (maximum 245 °C reflow temperature) soldering processes.

Mechanical Information (cont.)

Mounting Configuration

All dimensions are in millimeters (inches).

Notes:

1. A heatsink underneath the area of the PCB for the mounted device is recommended for proper thermal operation.
2. Ground / thermal vias are critical for the proper performance of this device. Vias have a final plated thru diameter of .40 mm (.016”).

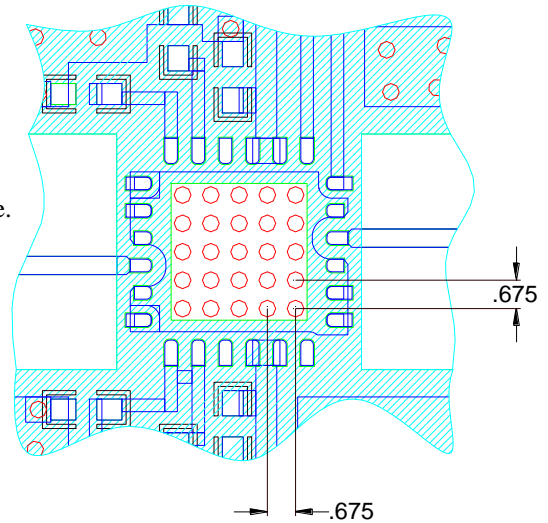

Tape and Reel Information

Tape and reel specifications for this part are also available on the TriQuint website in the “Application Notes” section. Standard T/R size = 500 pieces on a 7” x 0.5” reel.

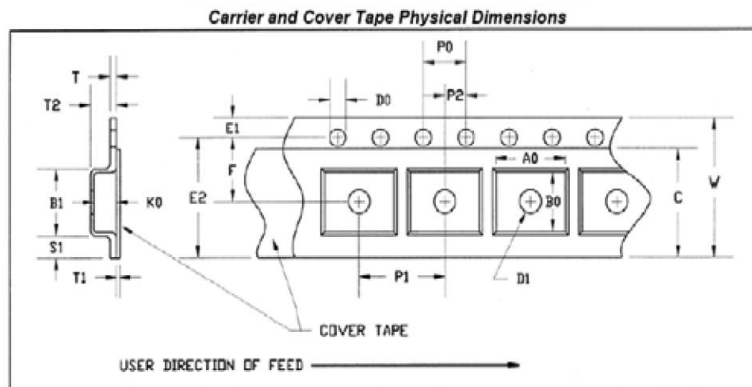

CARRIER AND COVER TAPE DIMENSIONS

Part	Feature	Symbol	Size (in)	Size (mm)
Cavity	Length	A0	0.207	5.25
	Width	B0	0.207	5.25
	Depth	K0	0.043	1.10
	Pitch	P1	0.315	8.00
Distance Between Centerline	Cavity to Perforation Length Direction	P2	0.079	2.00
	Cavity to Perforation Width Direction	F	0.217	5.50
Cover Tape	Width	C	0.374	9.5
Carrier Tape	Width	W	0.472	12.0

Product Compliance Information

ESD Information



Caution! ESD-Sensitive Device

ESD Rating: Class 0
 Value: ≥ 200 V and < 250 V
 Test: Human Body Model (HBM)
 Standard: JEDEC Standard JESD22-A114

MSL Rating

Level 1 at +260 °C convection reflow
 The part is rated Moisture Sensitivity Level 1 at 260°C per JEDEC standard IPC/JEDEC J-STD-020.

ECCN

US Department of Commerce: EAR99

Solderability

Compatible with the latest version of J-STD-020, Lead free solder, 260°C

This part is compliant with EU 2002/95/EC RoHS directive (Restrictions on the Use of Certain Hazardous Substances in Electrical and Electronic Equipment).

This product also has the following attributes:

- Lead Free
- Halogen Free (Chlorine, Bromine)
- Antimony Free
- TBBP-A (C₁₅H₁₂Br₄O₂) Free
- PFOS Free
- SVHC Free

Recommended Soldering Temperature Profile

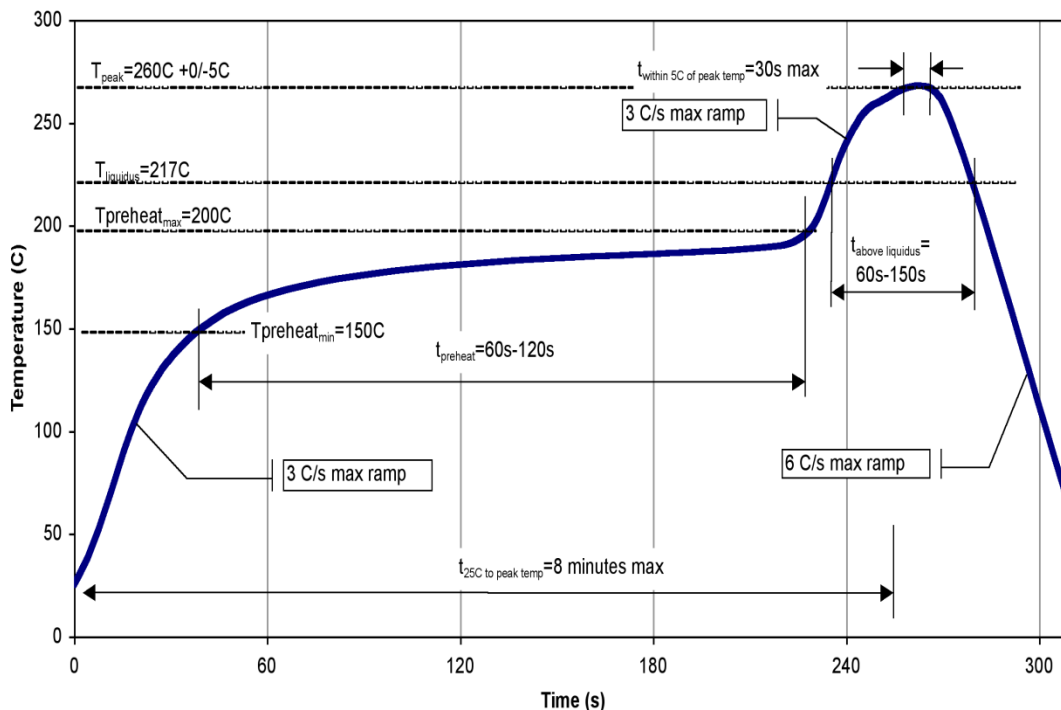

TGA2535-SM

X-Band Power Amplifier



Contact Information

For the latest specifications, additional product information, worldwide sales and distribution locations, and information about TriQuint:

Web: www.triquint.com
Email: info-sales@tqs.com

Tel: +1.972.994.8465
Fax: +1.972.994.8504

For technical questions and application information:

Email: info-networks@tqs.com

Important Notice

The information contained herein is believed to be reliable. TriQuint makes no warranties regarding the information contained herein. TriQuint assumes no responsibility or liability whatsoever for any of the information contained herein. TriQuint assumes no responsibility or liability whatsoever for the use of the information contained herein. The information contained herein is provided "AS IS, WHERE IS" and with all faults, and the entire risk associated with such information is entirely with the user. All information contained herein is subject to change without notice. Customers should obtain and verify the latest relevant information before placing orders for TriQuint products. The information contained herein or any use of such information does not grant, explicitly or implicitly, to any party any patent rights, licenses, or any other intellectual property rights, whether with regard to such information itself or anything described by such information.

TriQuint products are not warranted or authorized for use as critical components in medical, life-saving, or life-sustaining applications, or other applications where a failure would reasonably be expected to cause severe personal injury or death.

Mouser Electronics

Authorized Distributor

Click to View Pricing, Inventory, Delivery & Lifecycle Information:

[Qorvo:](#)

[TGA2535-SM](#)