



QPC1005

0.15 – 2.8 GHz 50 W GaN SPDT Switch

Product Overview

Qorvo’s QPC1005 is a Single-Pole, Double-Throw (SPDT) switch fabricated on Qorvo’s QGaN25 0.25um GaN on SiC production process.

Operating from 0.15 to 2.8 GHz, the QPC1005 typically supports 50 W input power handling at control voltages of 0/-40 V for both CW and pulsed RF operations. This switch maintains low insertion loss less than 0.7 dB and greater than 30 dB isolation, making it ideal for high power switching applications across both defense and commercial platforms.

QPC1005 is offered in a 4 x 4 mm plastic overmolded QFN package.

Lead-free and RoHS compliant

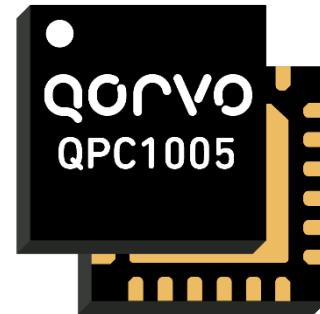

4mm x 4mm 24 Lead OVM QFN

Key Features

- SPDT
- Frequency Range: 0.15 to 2.8 GHz
- Input Power: 50 W
- Insertion Loss: < 0.7 dB
- Isolation: >30 dB Typical
- Switching Speed: 30 ns
- Control Voltages: 0 V/-40 V
- Redundant Control Lines
- Package Dimensions: 4 x 4 x 0.85 mm

Performance is typical across frequency. Please reference electrical specification table and data plots for more details.

Functional Block Diagram

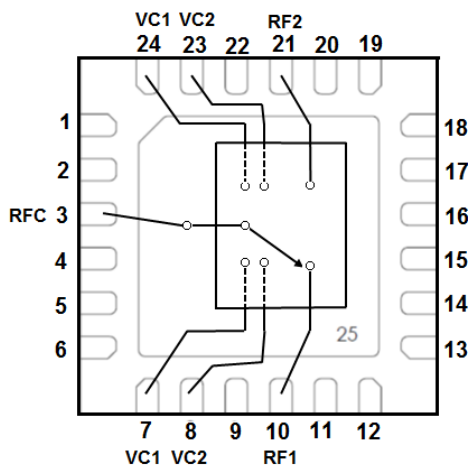

Applications

- Commercial and Military Radar
- Land Mobile Radios
- Military Communications Radios
- Electronic Warfare
- Test Instrumentation
- General Purpose

Ordering Information

| Part No. | Description |
|----------------|------------------------------|
| QPC1005 | 0.5–2.8 GHz 50 W SPDT Switch |
| QPC1005PCB4B01 | QPC1005 Evaluation Board |

Absolute Maximum Ratings

| Parameter | Rating |
|---|----------------|
| Control Voltage (V_c) | -50 V |
| Control Current (I_c) | -1.5 / +1.5 mA |
| Power Dissipation | 12 W |
| RF Input Power, CW, 50 Ω , T = 25 °C | 60 W |
| Mounting Temperature (30 sec) | 260 °C |
| Storage Temperature | -40 to 150 °C |

Exceeding any one or a combination of the Absolute Maximum Rating conditions may cause permanent damage to the device. Extended application of Absolute Maximum Rating conditions to the device may reduce device reliability.

Recommended Operating Conditions

| Parameter | Min | Typ. | Max | Units |
|-------------------|-----|-------|-----|-------|
| V_{C1} | | 0/-40 | | V |
| V_{C2} | | -40/0 | | V |
| Temperature Range | -40 | +25 | +85 | °C |

Electrical specifications are measured at specified test conditions. Specifications are not guaranteed over all recommended operating conditions.

Thermal and Reliability Information

| Parameter | Test Conditions | Value | Units |
|---|---|-------|-------|
| Thermal Resistance (θ_{JC}) ^(1,2) | $T_{BASE} = 85$ °C, $V_{C1} = 0$ V, $V_{C2} = -40$ V, Freq. = 2.8 GHz $P_{IN} = 60$ W, P_{DISS} ⁽³⁾ = 6.5 W, CW | 5.23 | °C/W |
| Channel Temperature (T_{CH}) ^(1,2) | | 119 | °C |

Notes:

1. Measured to the back of the package.
2. Refer to the following document: [GaN Device Channel Temperature, Thermal Resistance, and Reliability Estimates](#)
3. This is a total P_{DISS} in the FETs.

Electrical Specifications

Test conditions unless otherwise noted: 25 °C, $V_{C1} = 0\text{ V}/-40\text{ V}$, $V_{C2} = -40\text{ V}/0\text{ V}$, see function table on page 11.

| Parameter | Min | Typ. | Max | Units |
|---|----------------------|---------|------|-------|
| Operational Frequency Range | 0.15 | – | 2.8 | GHz |
| Insertion Loss (On-State) | Frequency = 0.15 GHz | – | 0.30 | dB |
| | Frequency = 1.0 GHz | – | 0.45 | |
| | Frequency = 2.8 GHz | – | 0.70 | |
| Input Return Loss (On-State) Common Port RL | Frequency = 0.15 GHz | – | 37 | dB |
| | Frequency = 1.0 GHz | – | 26 | |
| | Frequency = 2.8 GHz | – | 18 | |
| Output Return Loss (On-State) Switched Port RL | Frequency = 0.15 GHz | – | 34 | dB |
| | Frequency = 1.0 GHz | – | 29 | |
| | Frequency = 2.8 GHz | – | 18 | |
| Isolation (Off-State) | Frequency = 0.15 GHz | – | 57 | dB |
| | Frequency = 1.0 GHz | – | 40 | |
| | Frequency = 2.8 GHz | – | 29 | |
| Output Return Loss Isolated Port | Frequency = 0.15 GHz | – | 2.1 | dB |
| | Frequency = 1.0 GHz | – | 2.3 | |
| | Frequency = 2.8 GHz | – | 2.2 | |
| Insertion Loss @ $P_{IN} = 47\text{ dBm}$ (Pulsed RF) $PW = 100\mu\text{s}$; $DC = 10\%$ | Frequency = 0.15 GHz | – | 0.30 | dB |
| | Frequency = 1.0 GHz | – | 0.50 | |
| | Frequency = 2.8 GHz | – | 0.70 | |
| Insertion Loss @ $P_{IN} = 47\text{ dBm}$ (CW) | Frequency = 0.15 GHz | – | 0.30 | dB |
| | Frequency = 1.0 GHz | – | 0.50 | |
| | Frequency = 2.8 GHz | – | 0.75 | |
| Input Power ($P_{0.1dB}$) | – | 47 | – | dBm |
| Control Voltage | | -40 | -50 | V |
| Total Supply Current | | <3 | | mA |
| Switching Speed | | 30 | | ns |
| Insertion Loss Temperature Coefficient | – | -0.0015 | – | dB/°C |

Performance Plots – Small Signal

Notes: RFC = Port1; RF1 = Port 2; RF2 = Port 3

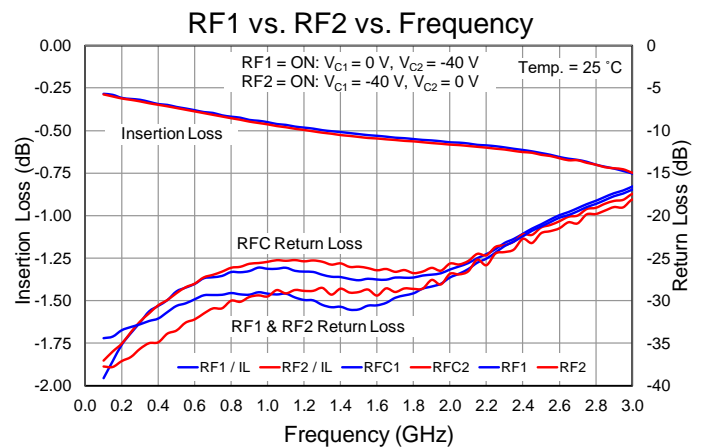
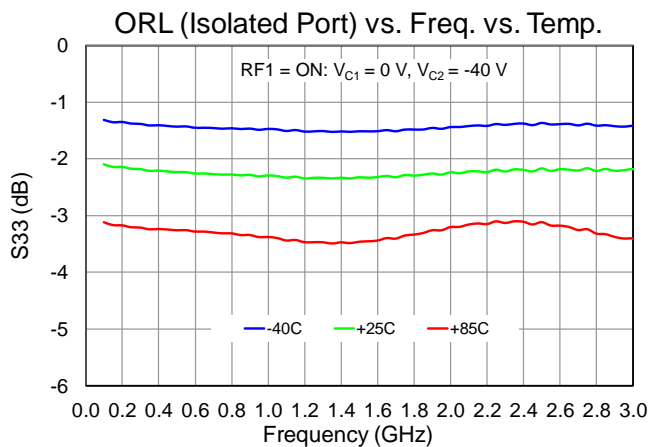
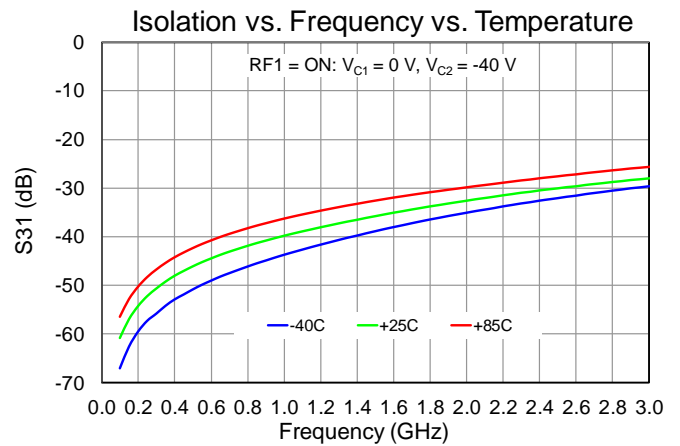
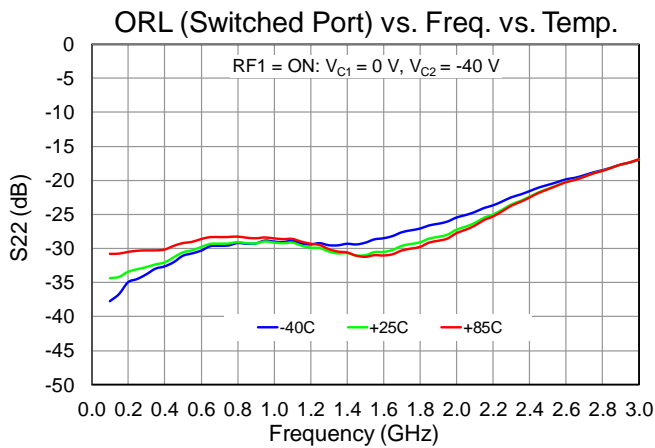
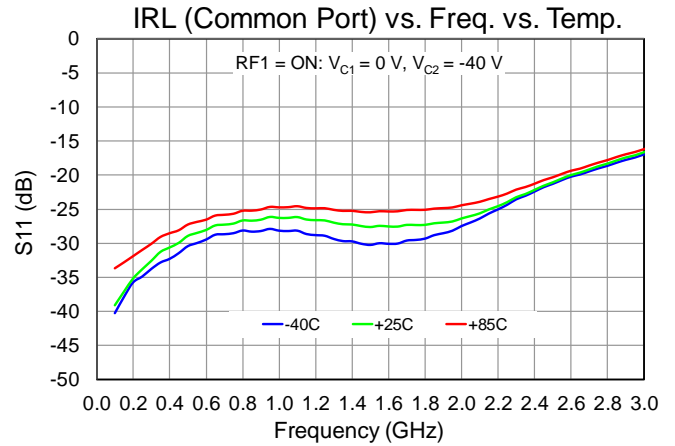
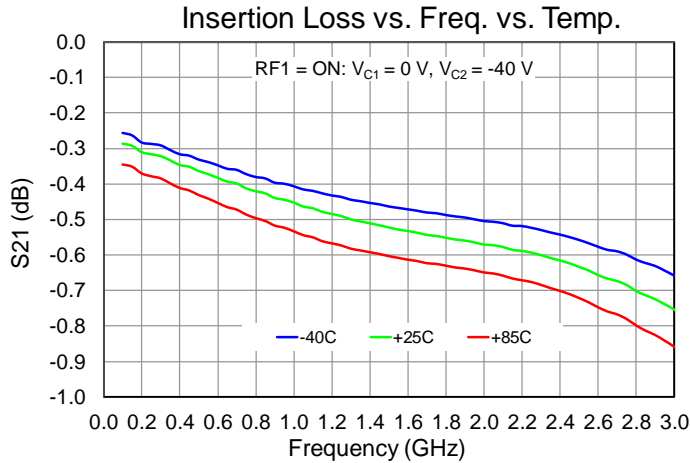

Performance Plots – Small Signal

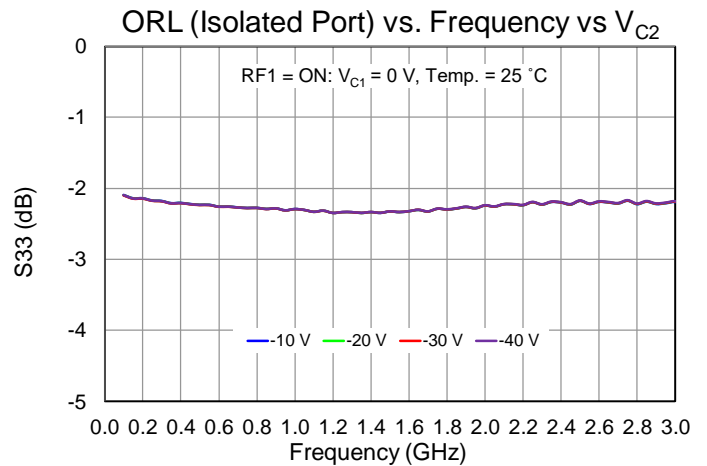
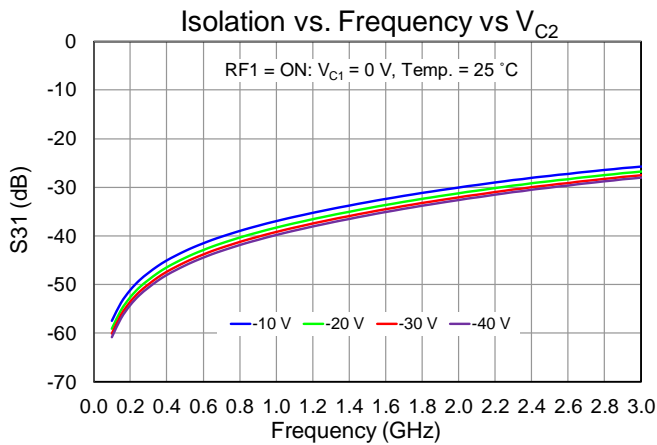
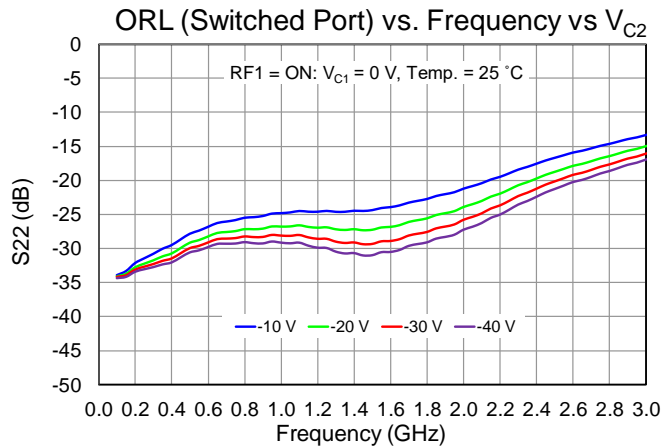
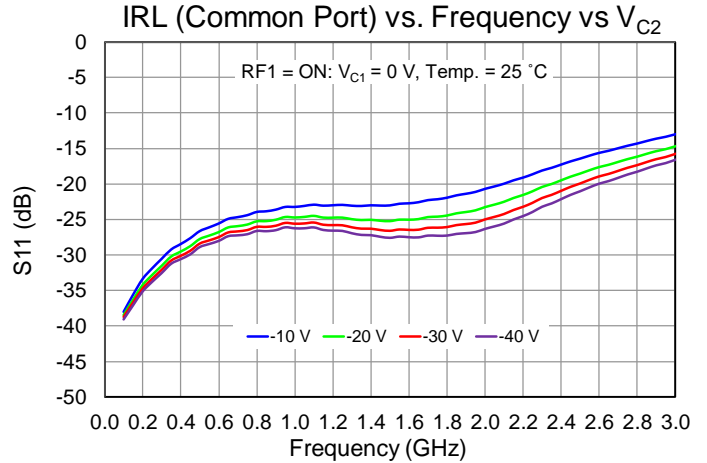
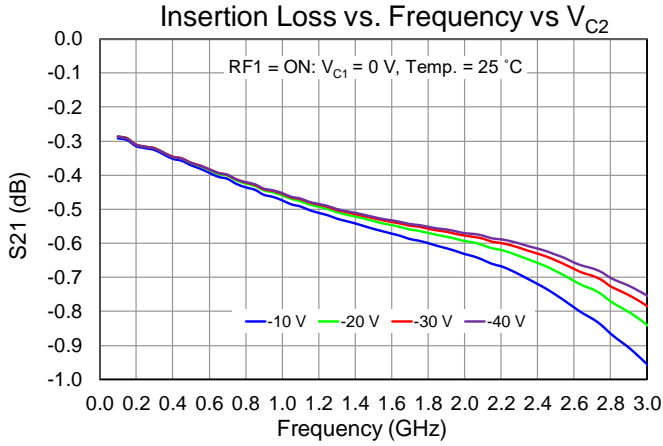

Performance Plots – Compression (Pulsed)

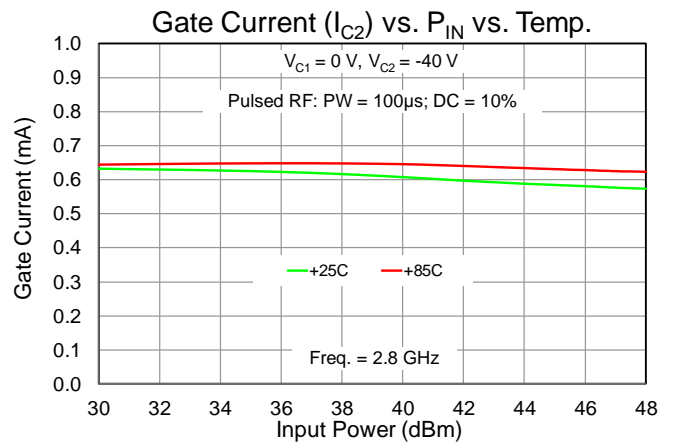
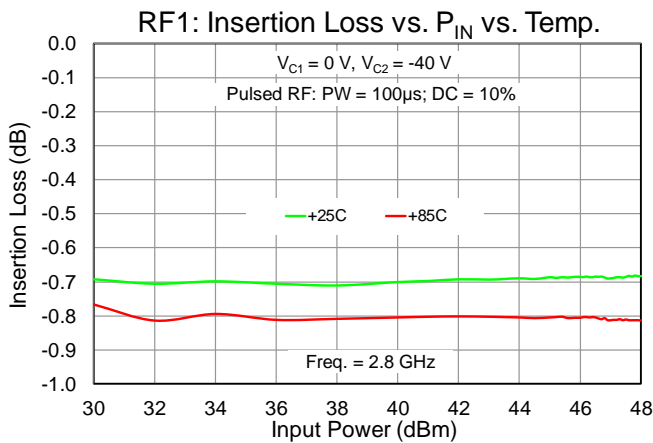
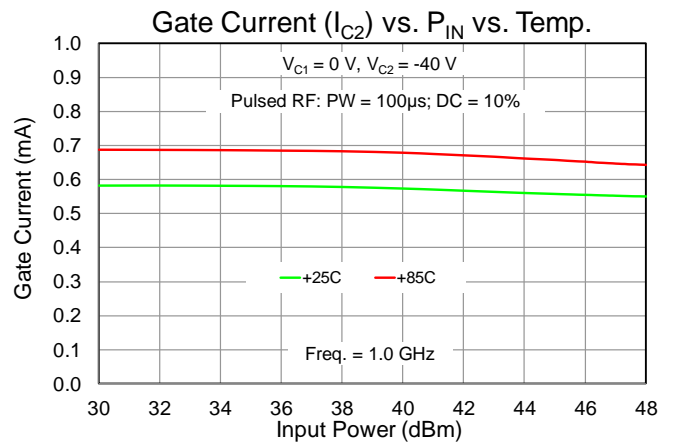
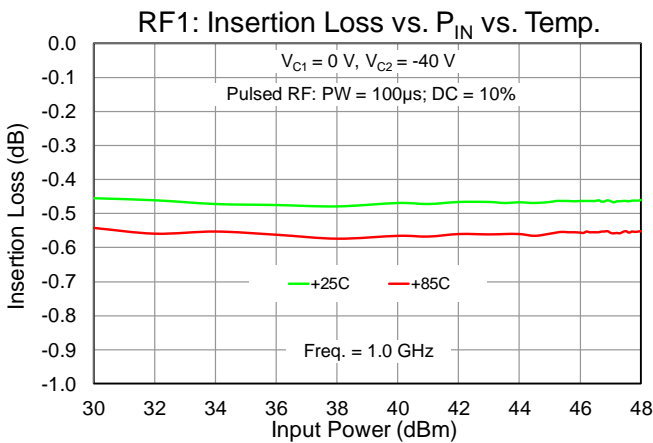
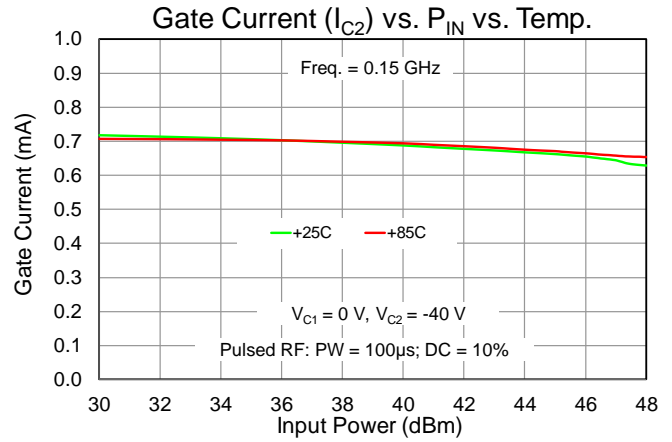
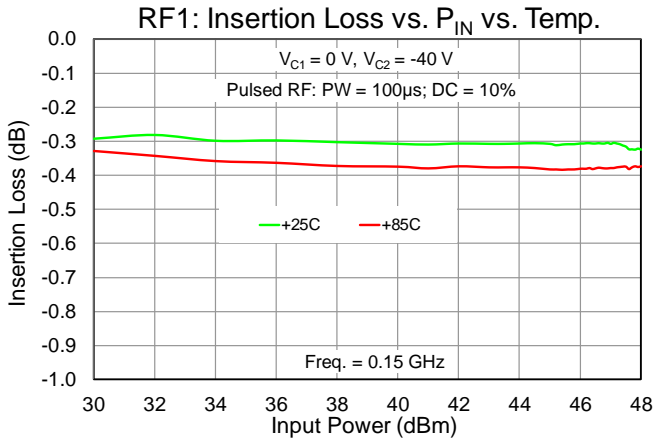

Performance Plots – Compression (Pulsed)

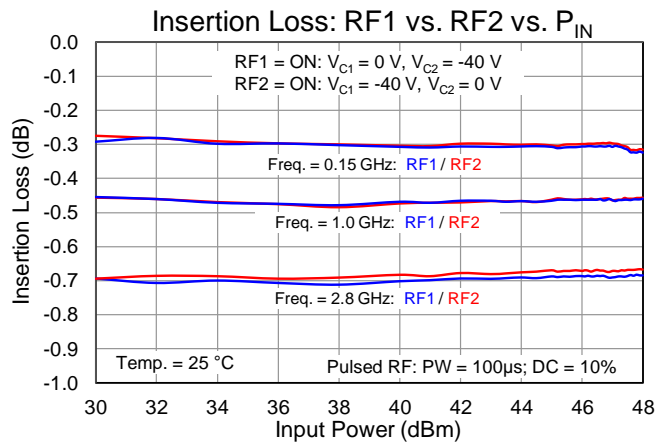
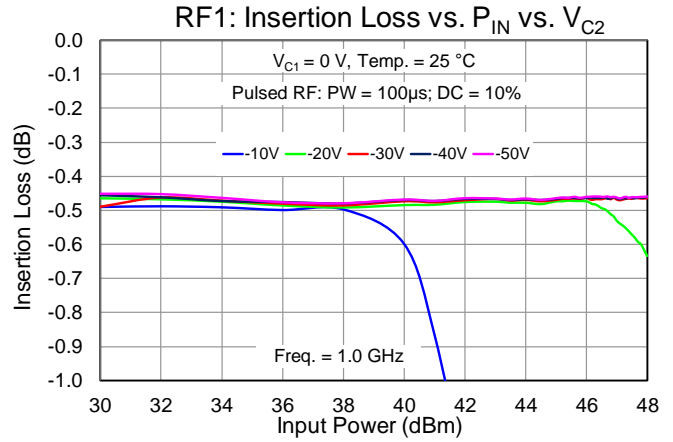
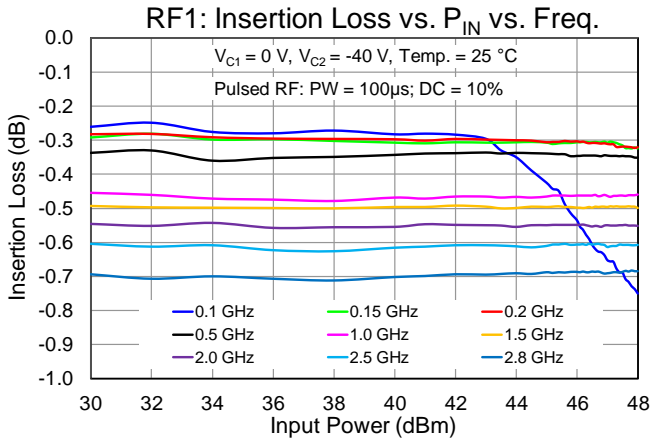

Performance Plots – Compression (CW)

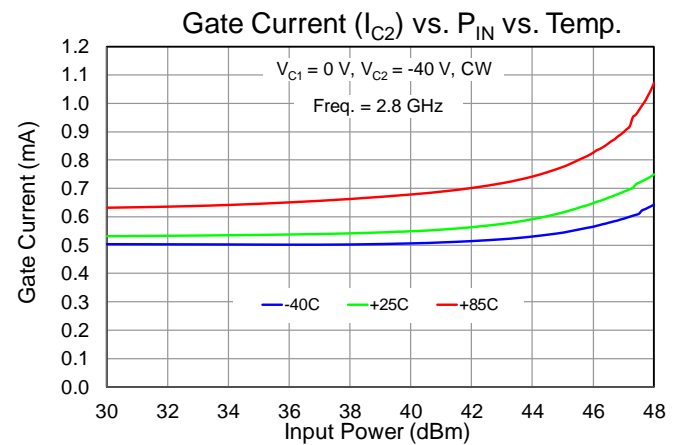
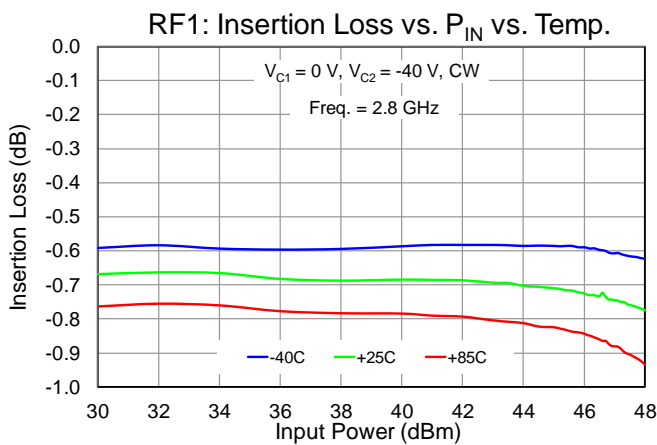
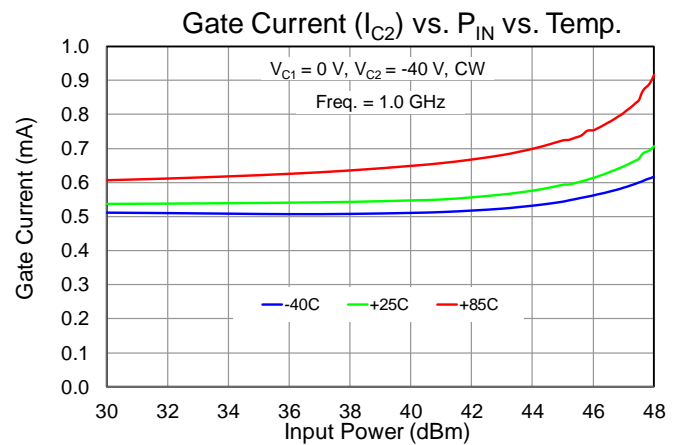
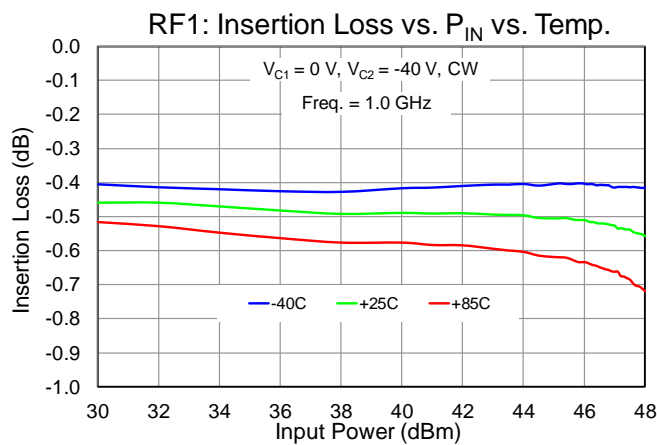
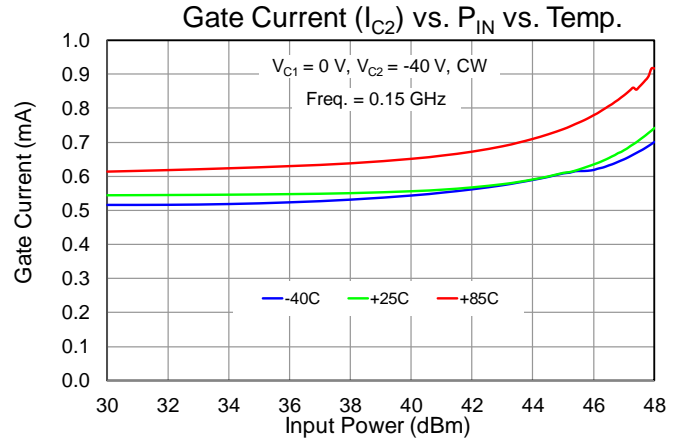
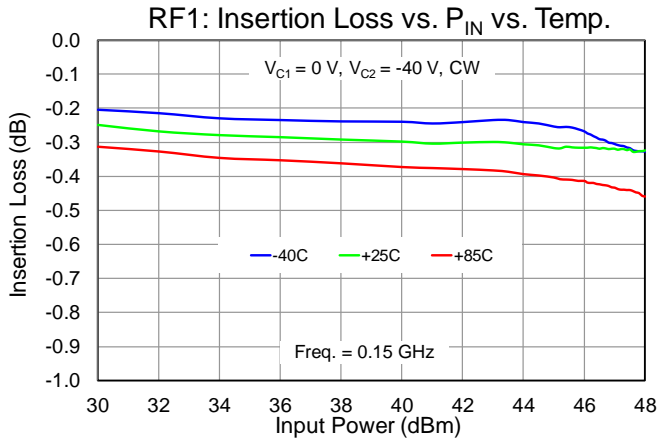

Performance Plots – Compression (CW)

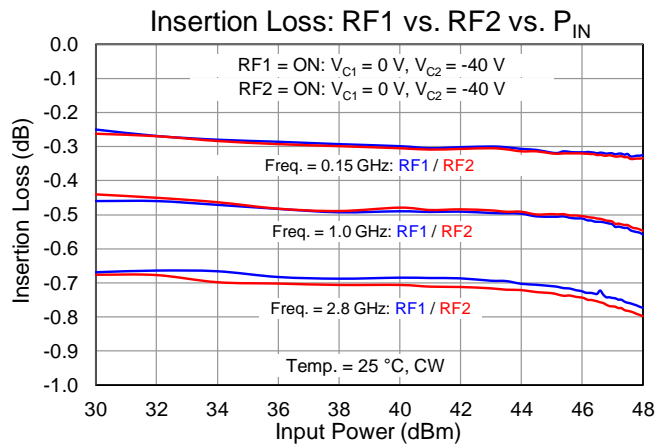
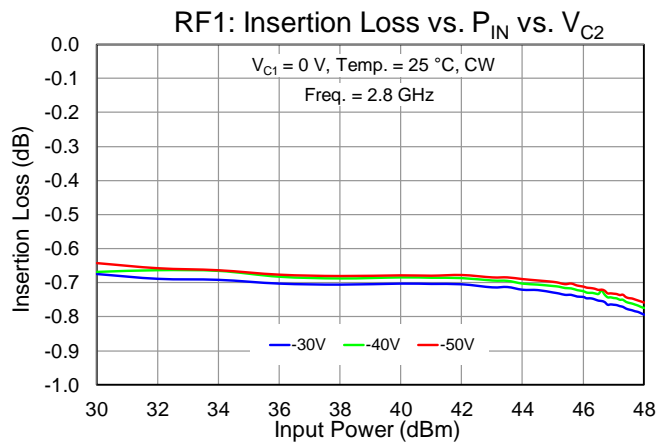
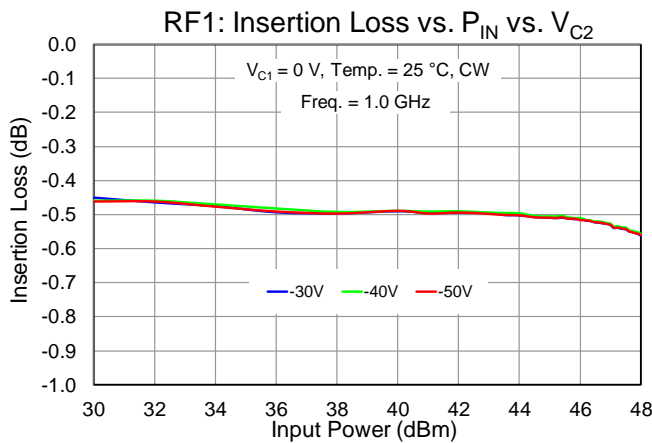
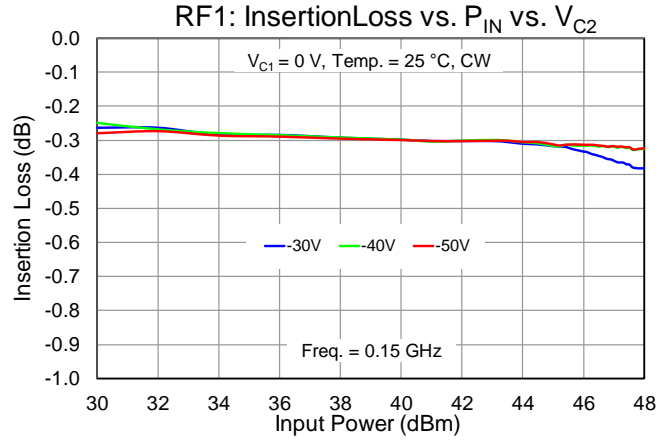
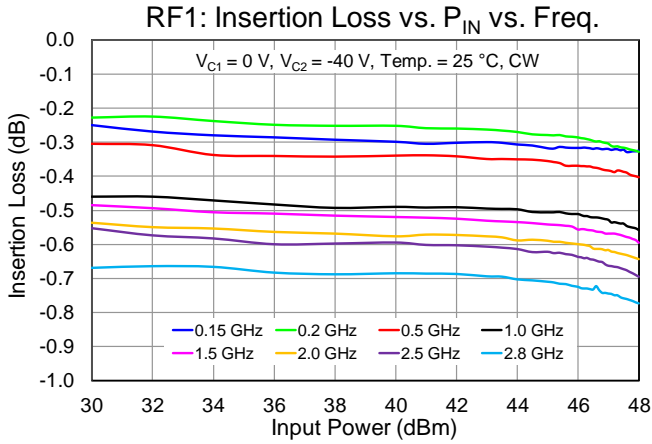

Performance Plots – Linearity

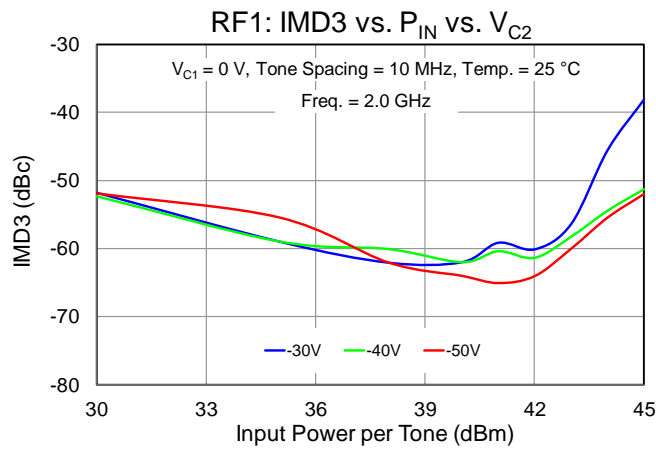
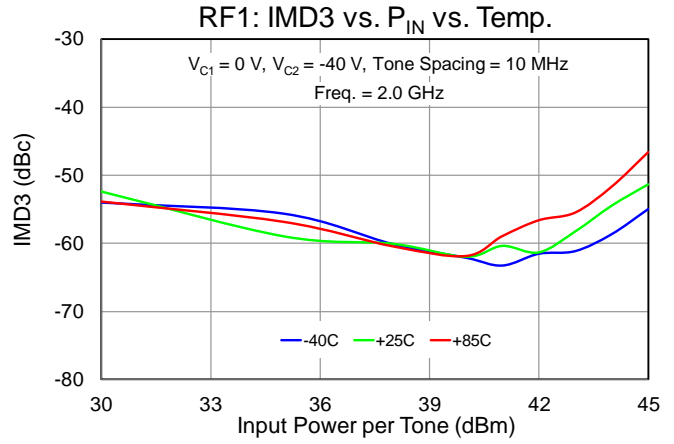
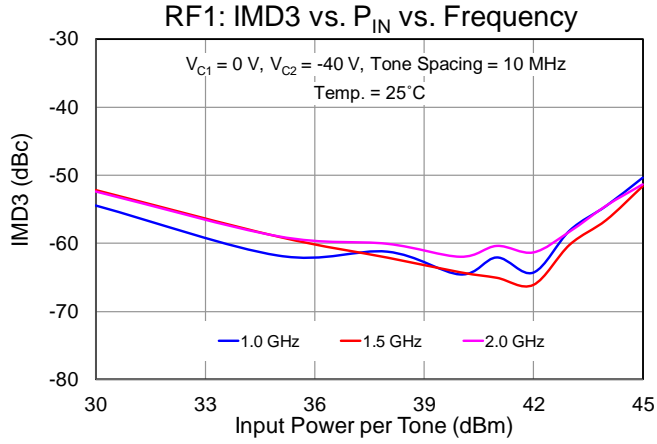

Application Circuit

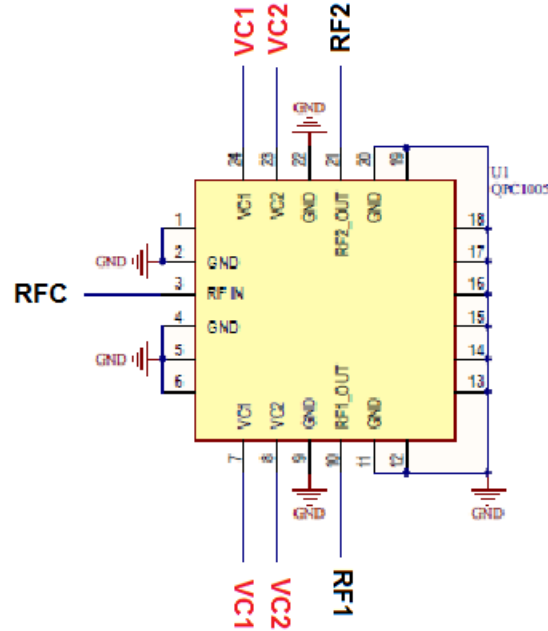

Notes:

1. This switch can be configured as a Single Pole, Single Throw (SPST) by terminating one unused RF switched port with a 50 Ohm load.
2. V_{C1} can be biased from either pin 7 or 24 and the non-biased pin can be left open.
3. V_{C2} can be biased from either pin 8 or 23 and the non-biased pin can be left open.
4. External components are not required

Bias Up Procedure

1. V_{C1} or V_{C2} set to 0 V (see Function Table for RF Path)
2. V_{C2} or V_{C1} set to -40 V (see Function Table for RF Path)
3. Apply RF signal to RF Input

Bias Up Down

1. Turn off RF supply
2. Turn V_{C2} or V_{C1} to 0 V
3. Turn V_{C1} or V_{C2} to 0 V

Function Table

| RF Path | State | V_{C1} | V_{C2} |
|---------------|---------------------------|----------|----------|
| RFC to RF1 ON | On-State (Insertion Loss) | 0 V | -40 V |
| | Off-State (Isolation) | -40 V | 0 V |
| RFC to RF2 ON | On-State (Insertion Loss) | -40 V | 0 V |
| | Off-State (Isolation) | 0 V | -40 V |

Evaluation Board (EVB) Assembly Layout.

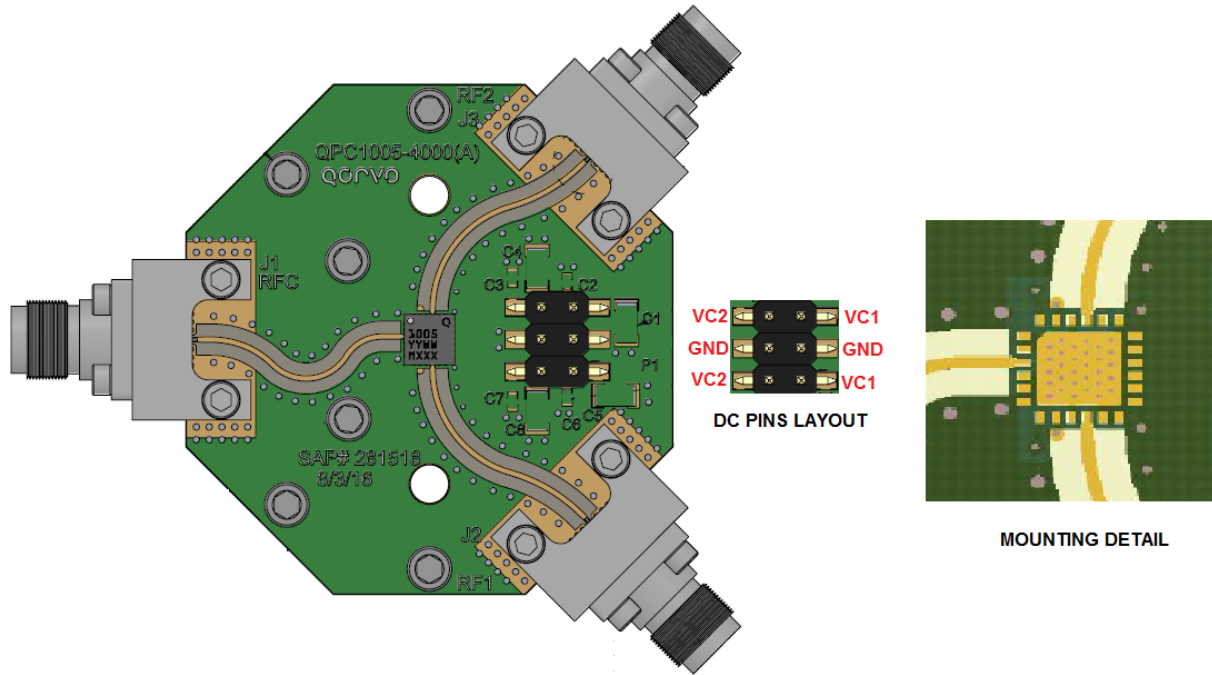

Notes:

1. This switch can be configured as a Single Pole, Single Throw (SPST) by terminating one unused RF switched port with a 50 Ohm load.
2. V_{C1} can be biased from either pin and the non-biased pin can be left open.
3. V_{C2} can be biased from either pin and the non-biased pin can be left open.
4. External components are not required

Mechanical Information

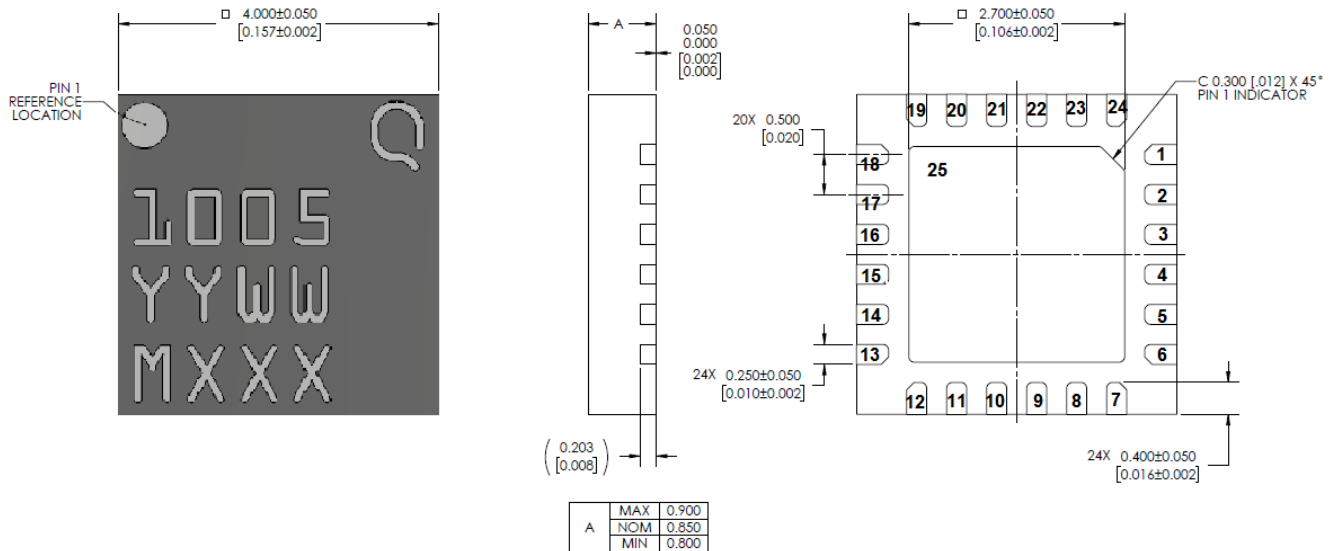

Units: millimeters

Tolerances: unless specified

x.xx = ± 0.25

x.xxx = ± 0.100

Materials:

Base: Cu Alloy

Packaged Exposed Metallization is gold plated

Marking:

QPC1005: Part number

YY: Part Assembly year

WW: Part Assembly week

MXXX: Batch ID

Pin Description

| Pad No. | Symbol | Description |
|-----------------|-----------------|--|
| 1, 5, 6, 11-20, | N/C | Not connected internally. Recommended to be grounded at EVB level |
| 2, 4, 9, 22 | GND | Ground. Connected to GND paddle (pin 25); should be grounded on PCB to improve isolation |
| 3 | RFC | RF common port (port 1); matched to 50 Ω; DC coupled |
| 7, 24 | V _{C1} | Control voltage #1; External components are not required |
| 8, 23 | V _{C2} | Control voltage #2; External components are not required |
| 10 | RF1 | RF switched port 2; matched to 50 Ω; DC coupled |
| 21 | RF2 | RF switched port 3; matched to 50 Ω; DC coupled |
| 25 | GND | Backside Paddle. Multiple vias should be employed to minimize inductance and thermal resistance. |

Solderability

1. Compatible with the latest version of J-STD-020, Lead-free solder, 260° C soldering process.
2. The use of no-clean solder to avoid washing after soldering is recommended.
3. Contact plating: Ni-Pd-Au.

Recommended Soldering Profile

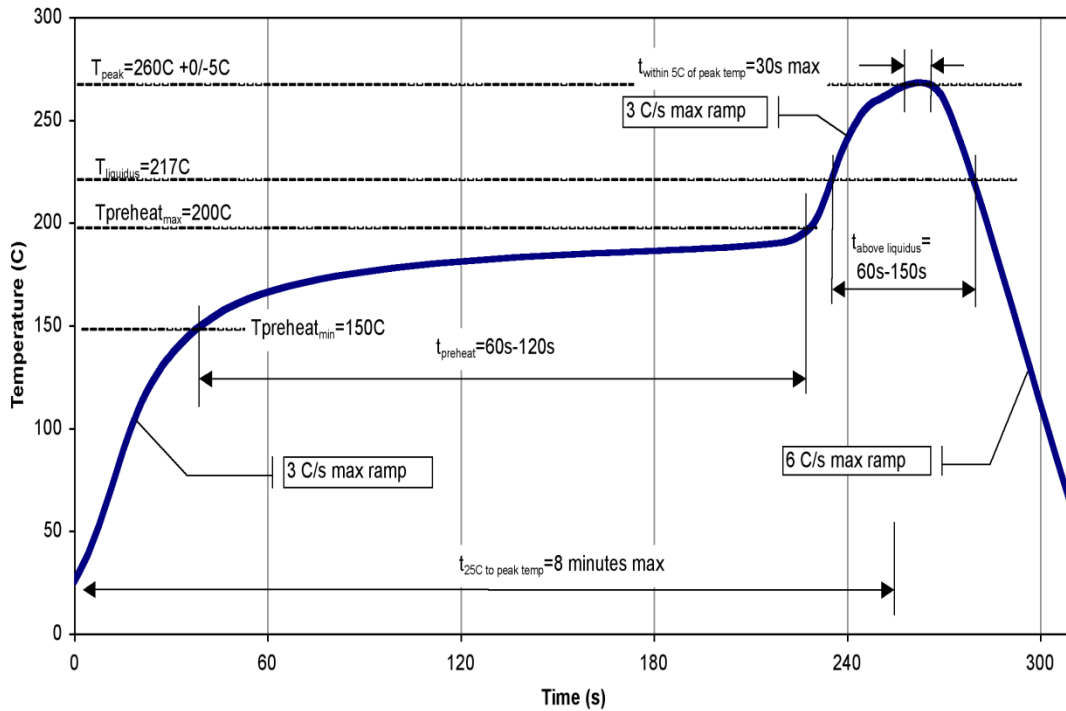

Handling Precautions

| Parameter | Rating | Standard |
|----------------------------------|----------|------------------------------------|
| ESD – Human Body Model (HBM) | Class 1A | ESDA / JEDEC JS-001-2012 |
| ESD – Charged Device Model (CDM) | TBD | ESDA / JEDEC JS-002-2014 |
| MSL – Convection Reflow 260 °C | Level 3 | JEDEC standard IPC/JEDEC J-STD-020 |



Caution!
ESD-Sensitive Device

RoHS Compliance

This part is compliant with 2011/65/EU RoHS directive (Restrictions on the Use of Certain Hazardous Substances in Electrical and Electronic Equipment) as amended by Directive 2015/863/EU.

This product also has the following attributes:

- Lead Free
- Halogen Free (Chlorine, Bromine)
- Antimony Free
- TBBP-A (C₁₅H₁₂Br₄O₂) Free
- PFOS Free
- SVHC Free

Contact Information

For the latest specifications, additional product information, worldwide sales and distribution locations:

Web: www.qorvo.com

Tel: 1-844-890-8163

Email: customer.support@qorvo.com

Important Notice

The information contained herein is believed to be reliable; however, Qorvo makes no warranties regarding the information contained herein and assumes no responsibility or liability whatsoever for the use of the information contained herein. All information contained herein is subject to change without notice. Customers should obtain and verify the latest relevant information before placing orders for Qorvo products. The information contained herein or any use of such information does not grant, explicitly or implicitly, to any party any patent rights, licenses, or any other intellectual property rights, whether with regard to such information itself or anything described by such information. **THIS INFORMATION DOES NOT CONSTITUTE A WARRANTY WITH RESPECT TO THE PRODUCTS DESCRIBED HEREIN, AND QORVO HEREBY DISCLAIMS ANY AND ALL WARRANTIES WITH RESPECT TO SUCH PRODUCTS WHETHER EXPRESS OR IMPLIED BY LAW, COURSE OF DEALING, COURSE OF PERFORMANCE, USAGE OF TRADE OR OTHERWISE, INCLUDING THE IMPLIED WARRANTIES OF MERCHANTABILITY AND FITNESS FOR A PARTICULAR PURPOSE.**

Without limiting the generality of the foregoing, Qorvo products are not warranted or authorized for use as critical components in medical, life-saving, or life-sustaining applications, or other applications where a failure would reasonably be expected to cause severe personal injury or death.

Copyright 2019 © Qorvo, Inc. | Qorvo is a registered trademark of Qorvo, Inc.

Mouser Electronics

Authorized Distributor

Click to View Pricing, Inventory, Delivery & Lifecycle Information:

[Qorvo:](#)

[QPC1005EVB](#) [QPC1005SR](#) [QPC1005](#)