



TGA2752-SM

7.1 – 8.5 GHz Power Amplifier

Product Overview

The Qorvo TGA2752-SM is a C-Band Power Amplifier with integrated power detector. The TGA2752-SM operates from 7.1 – 8.5 GHz and is designed using Qorvo’s power GaAs pHEMT and GaN HEMT production processes.

The TGA2752-SM typically provides 40 dBm of saturated output power with small signal gain of 28 dB. Third Order Intercept is 48 dBm at 30 dBm SCL.

The TG2752-SM is available in a low-cost, surface mount 42 lead 7 x 9 mm QFN package and is ideally suited for Point-to-Point Radio.

Lead-free and RoHS compliant.



42-Lead 7.0 x 9.0 x 0.9 mm Package

Key Features

- Frequency Range: 7.1 – 8.5 GHz
- Power: +40 dBm Psat
- Gain: 28 dB
- TOI: 48 dBm at 30 dBm/tone
- Integrated Power Detector
- Bias: $V_{D1} = V_{D2} = +6\text{ V}$, $I_{D1} + I_{D2} = 1000\text{ mA}$, $V_{D3} = +28\text{ V}$, $I_{D3} = 190\text{ mA}$
- Package Dimensions: 7.0 x 9.0 x 0.9 mm

Functional Block Diagram

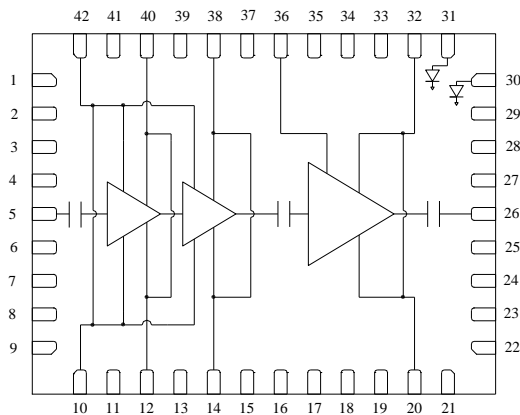

Top View

Applications

- Point-to-Point Radio
- Linear C-band Sat-Com

Ordering Information

Part No.	Description
TGA2752-SM T/R	500 pieces on a 7" reel (standard)
TGA2752-SM Eval Board	Evaluation Board
TGA2752-SM, Sample	Waffle Tray with 4 pcs

Absolute Maximum Ratings

Parameter	Rating
Drain Voltage, V_{D1} , V_{D2}	+9 V
Drain Voltage, V_{D3}	+32 V
Drain Current, $I_{D1} + I_{D2}$	2443 mA
Drain Current, I_{D3}	825 mA
Gate Voltage, V_{G12}	-1.2 V / +0.5 V
Gate Voltage, V_{G3}	-8 V / 0 V
Power Dissipation, Driver Stages, P_{DISS}	7.2 W
Power Dissipation, Final Stage, P_{DISS}	17 W
RF Input Power, CW, 50 Ω , T = 25 °C	+29 dBm
Mounting Temperature (30 Seconds)	260 °C
Storage Temperature	-40 to 150 °C

Exceeding any one or a combination of the Absolute Maximum Rating conditions may cause permanent damage to the device. Extended application of Absolute Maximum Rating conditions to the device may reduce device reliability.

Recommended Operating Conditions

Parameter	Min	Typ	Max	Units
Operating Temp. Range	-40	+25	+85	°C
V_{D1} , V_{D2}		+6		V
V_{D3}		+28		V
$I_{D1} + I_{D2}$		1000		mA
I_{D3}		190		mA
V_{G12}		-0.65		V
V_{G3}		-2.6		V
$I_{D1} + I_{D2}$ drive (at +34 dBm Pout)		1050		mA
I_{D3} drive (at +34 dBm Pout)		400		mA

Electrical specifications are measured at specified test conditions. Specifications are not guaranteed over all recommended operating conditions.

Electrical Specifications

Parameter	Conditions ⁽¹⁾	Min	Typ	Max	Units
RF Frequency Range		7.1		8.5	GHz
Small Signal Gain		24	28		dB
Input Return Loss, IRL			12		dB
Output Return Loss, ORL			15		dB
Output Power at Saturation, P_{sat}		+38	+40		dBm
Output Power at 1 dB Gain Compression, P_{1dB}			+30		dBm
Output Third Order Intercept, TOI @ 30 dBm/Tone			+48		dBm
GaN Gate Leakage	$V_{D3} = 10$ V $V_{G3} = -3.7$ V	-4.2			mA
Gain Temperature Coefficient			-0.035		dB / °C
Power Temperature Coefficient			-0.012		dBm / °C

Notes:
1. Test conditions unless otherwise noted: $V_{D1} = V_{D2} = +6$ V, $I_{D1} + I_{D2} = 1000$ mA, $V_{G1} = V_{G2} = -0.7$ V, $V_{D3} = +28$ V, $I_{D3} = 190$ mA, $V_{G3} = -2.6$ V, Temp = +25 °C, $Z_0 = 50$ Ω

Thermal and Reliability Information (GaAs Driver Stages)

Parameter	Test Conditions	Value	Units
Thermal Resistance (θ_{JC}) ⁽¹⁾	CW	6.17	°C/W
Channel Temperature, T_{CH}	$T_{baseplate} = +85\text{ °C}$, $V_{D\ Driver} = +6\text{ V}$, $I_{DQ} = 1000\text{ mA}$, $P_{DISS} = 6.0\text{ W}$	139	°C
Thermal Resistance (θ_{JC}) ⁽¹⁾	CW	6.19	°C/W
Channel Temperature, T_{CH} (Under RF)	$T_{baseplate} = +85\text{ °C}$, $V_{D\ Driver} = +6\text{ V}$, $I_{D\ Driver} = 1050\text{ mA}$, $P_{OUT} = +34\text{ dBm}$, $P_{DISS} = 6.3\text{ W}$	142	°C

Notes:

1. Thermal resistance measured at back of package.

Thermal and Reliability Information (GaN Final Stage)

Parameter	Test Conditions	Value	Units
Thermal Resistance (θ_{JC}) ⁽¹⁾	CW	5.66	°C/W
Channel Temperature, T_{CH} ⁽²⁾	$T_{baseplate} = +85\text{ °C}$, $V_{D\ Driver} = +28\text{ V}$, $I_{DQ} = 190\text{ mA}$, $P_{DISS} = 5.3\text{ W}$	115	°C
Thermal Resistance (θ_{JC}) ⁽¹⁾	CW	5.52	°C/W
Channel Temperature, T_{CH} (Under RF) ⁽²⁾	$T_{baseplate} = +85\text{ °C}$, $V_{D\ Driver} = +28\text{ V}$, $I_{D\ Final} = 400\text{ mA}$, $P_{OUT} = +34\text{ dBm}$, $P_{DISS} = 8.7\text{ W}$	133	°C

Notes:

1. Thermal resistance measured at back of package.
2. IR scan equivalent. Refer to the following document: [GaN Device Channel Temperature, Thermal Resistance, and Reliability Estimates](#)

Performance Plots

Test conditions unless otherwise noted: $V_{D1} = V_{D2} = +6\text{ V}$, $I_{D1} + I_{D2} = 1000\text{ mA}$, $V_{G1} = V_{G2} = -0.65\text{ V}$, $V_{D3} = +28\text{ V}$, $I_{D3} = 190\text{ mA}$, $V_{G3} = -2.6\text{ V}$, $\text{Temp} = +25\text{ }^\circ\text{C}$, $Z_0 = 50\text{ }\Omega$

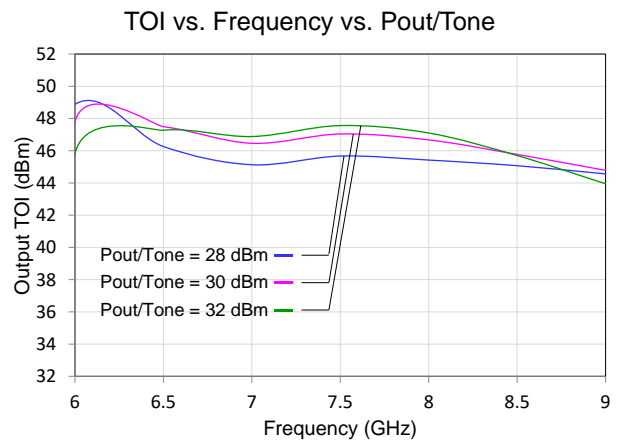
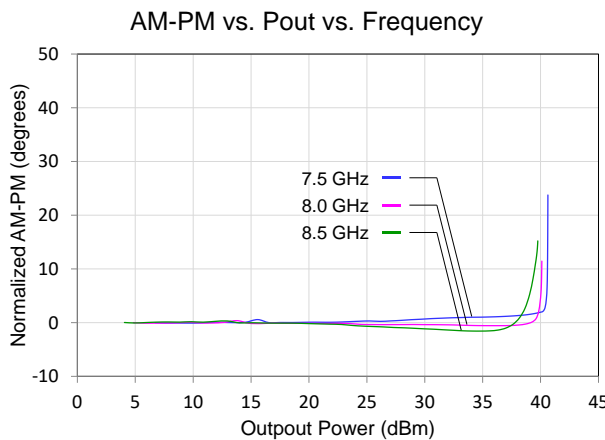
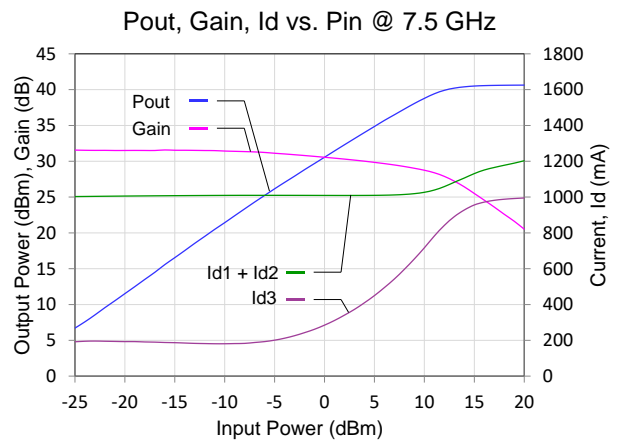
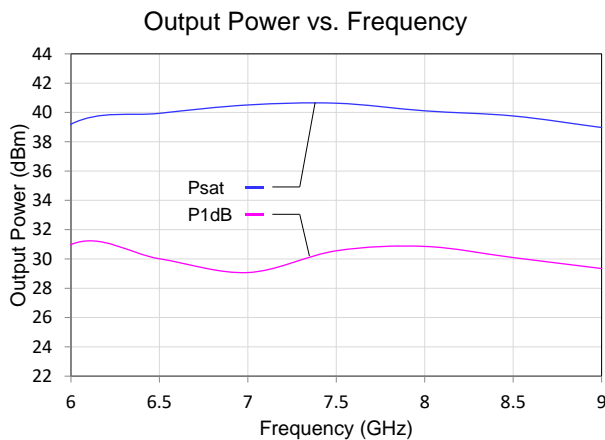
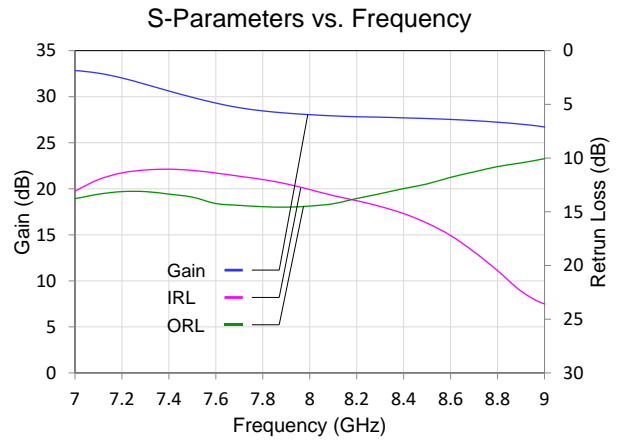
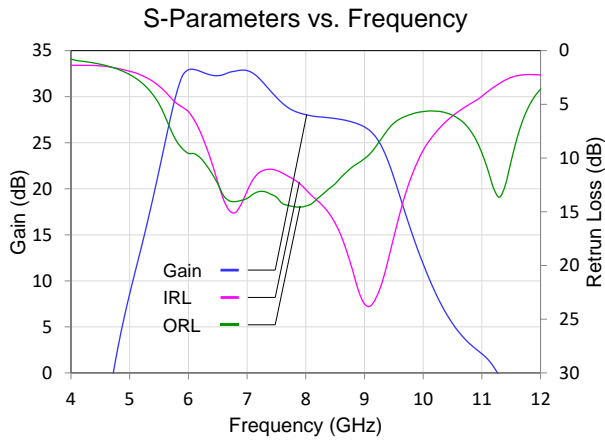

Performance Plots

Test conditions unless otherwise noted: $V_{D1} = V_{D2} = +6\text{ V}$, $I_{D1} + I_{D2} = 1000\text{ mA}$, $V_{G1} = V_{G2} = -0.65\text{ V}$, $V_{D3} = +28\text{ V}$, $I_{D3} = 190\text{ mA}$, $V_{G3} = -2.6\text{ V}$, $\text{Temp} = +25\text{ }^\circ\text{C}$, $Z_0 = 50\text{ }\Omega$

IM3 vs. Pout/Tone vs. Frequency

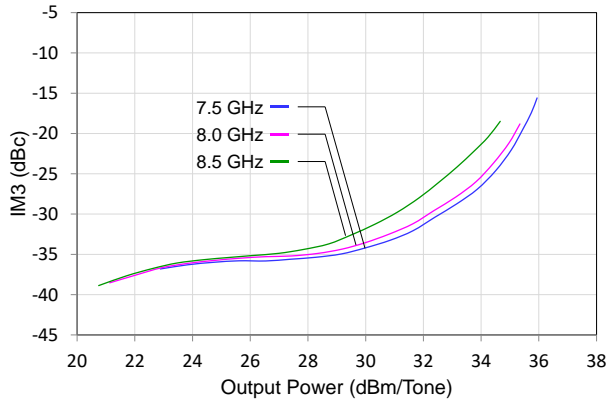

IM5 vs. Pout/Tone vs. Frequency

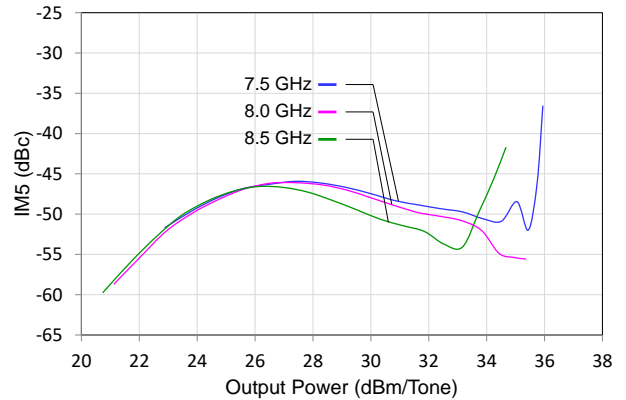

Gain vs. Frequency vs. Bias

$V_{d3} = 28\text{ V}$, $I_{d3} = 190\text{ mA}$, $V_{g3} = -2.6\text{ V}$ Typical

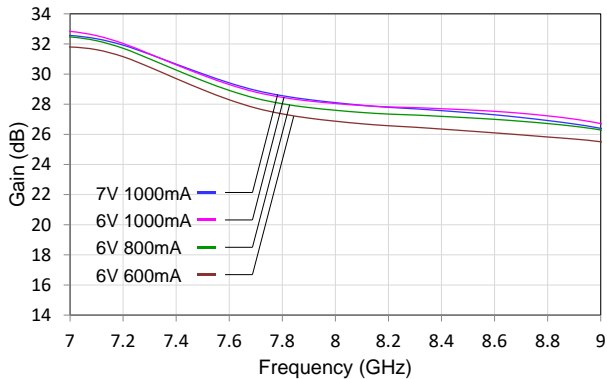

Gain vs. Frequency vs. Bias

$V_{d1} = V_{d2} = 6\text{ V}$, $I_{d1} + I_{d2} = 1000\text{ mA}$, $V_{g12} = -0.65\text{ V}$ Typical

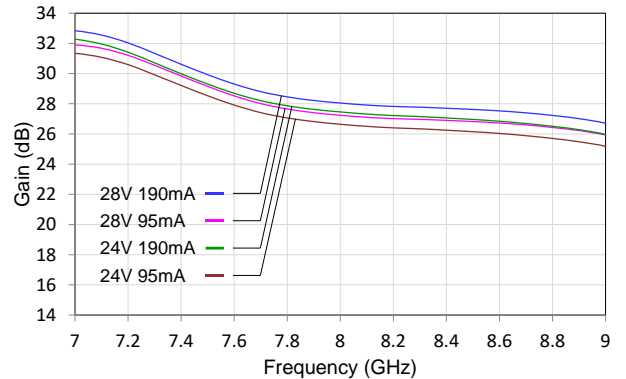

Psat vs. Frequency vs. Bias

$V_{d3} = 28\text{ V}$, $I_{d3} = 190\text{ mA}$, $V_{g3} = -2.6\text{ V}$ Typical

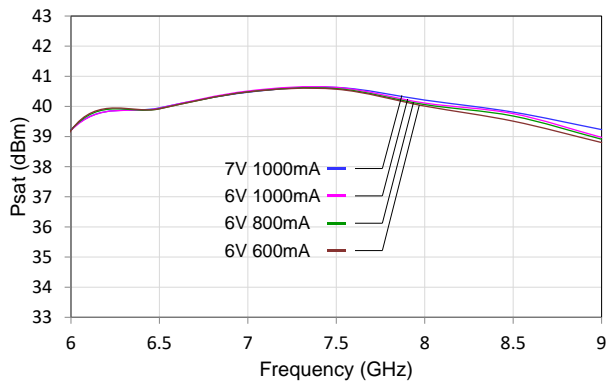

Psat vs. Frequency vs. Bias

$V_{d1} = V_{d2} = 6\text{ V}$, $I_{d1} + I_{d2} = 1000\text{ mA}$, $V_{g12} = -0.65\text{ V}$ Typical

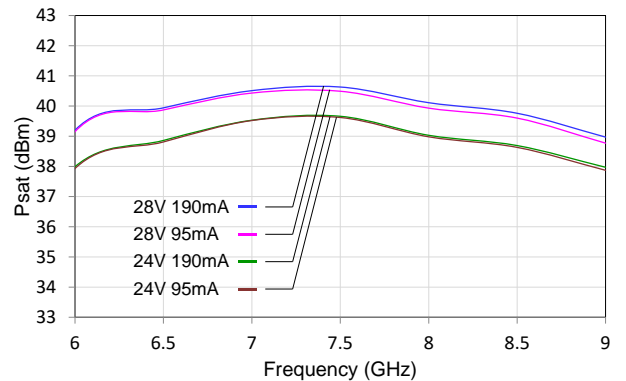

Performance Plots

Test conditions unless otherwise noted: $V_{D1} = V_{D2} = +6\text{ V}$, $I_{D1} + I_{D2} = 1000\text{ mA}$, $V_{G1} = V_{G2} = -0.65\text{ V}$, $V_{D3} = +28\text{ V}$, $I_{D3} = 190\text{ mA}$, $V_{G3} = -2.6\text{ V}$, $\text{Temp} = +25\text{ }^\circ\text{C}$, $Z_0 = 50\text{ }\Omega$

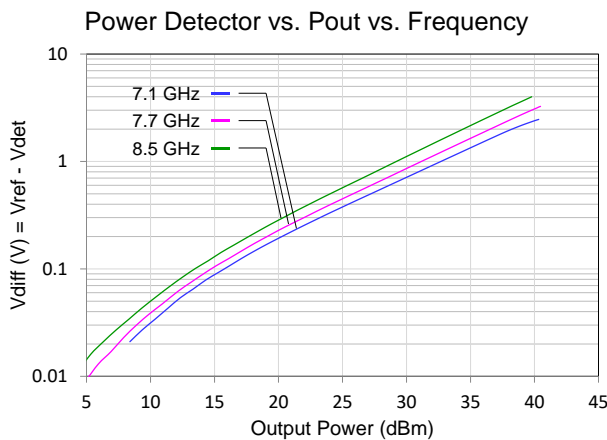
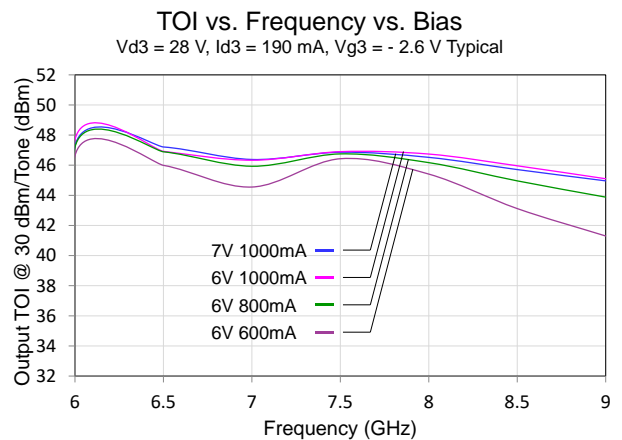
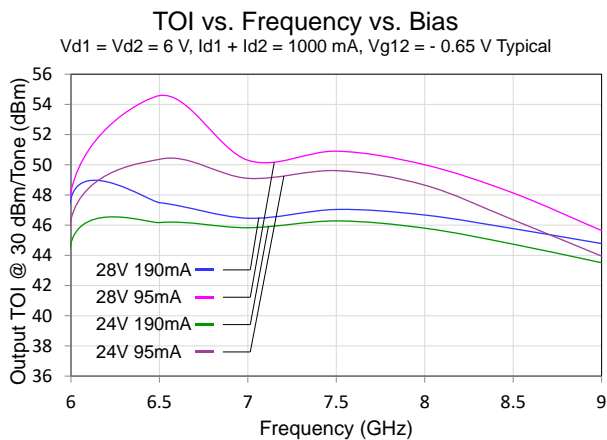
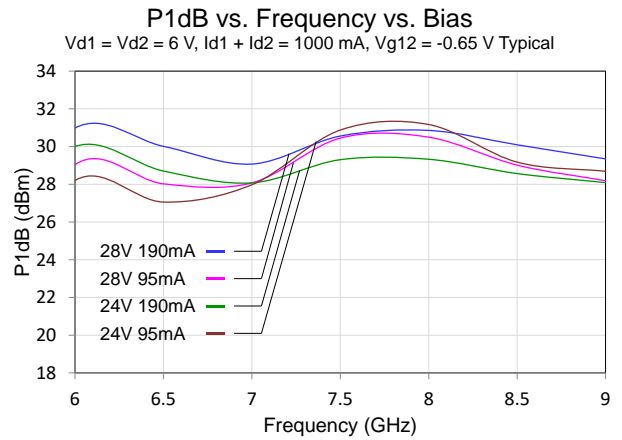
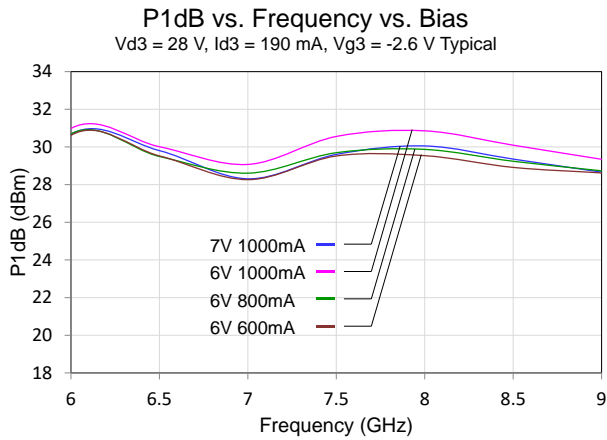

Performance Plots

Test conditions unless otherwise noted: $V_{D1} = V_{D2} = +6\text{ V}$, $I_{D1} + I_{D2} = 1000\text{ mA}$, $V_{G1} = V_{G2} = -0.65\text{ V}$, $V_{D3} = +28\text{ V}$, $I_{D3} = 190\text{ mA}$, $V_{G3} = -2.6\text{ V}$, $\text{Temp} = +25\text{ }^\circ\text{C}$, $Z_0 = 50\text{ }\Omega$

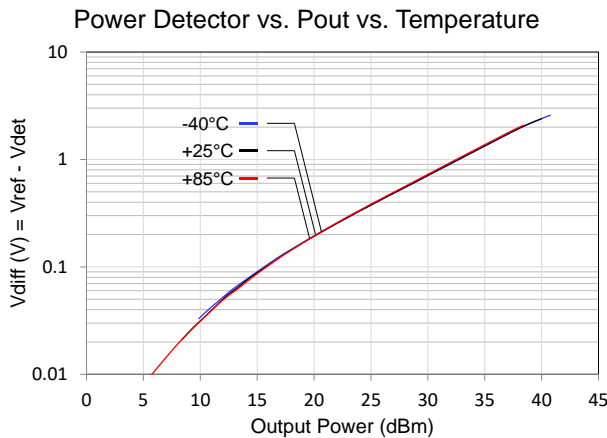
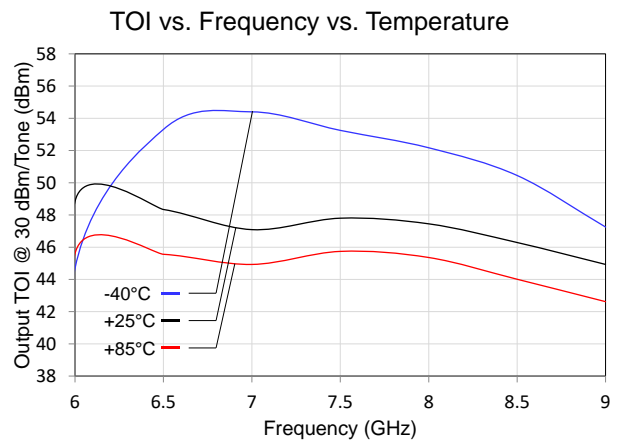
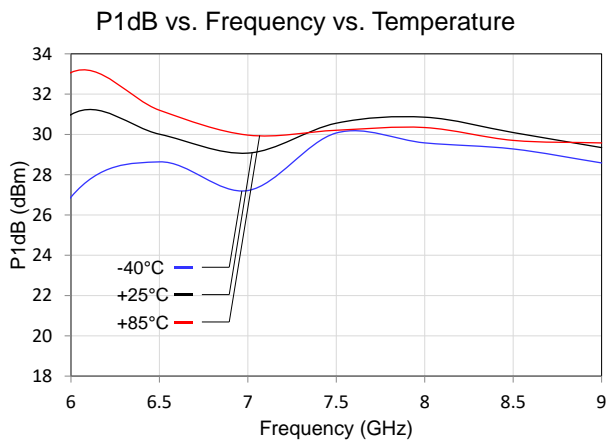
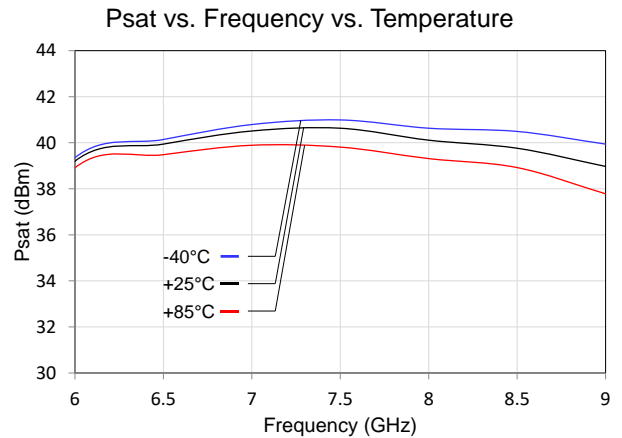
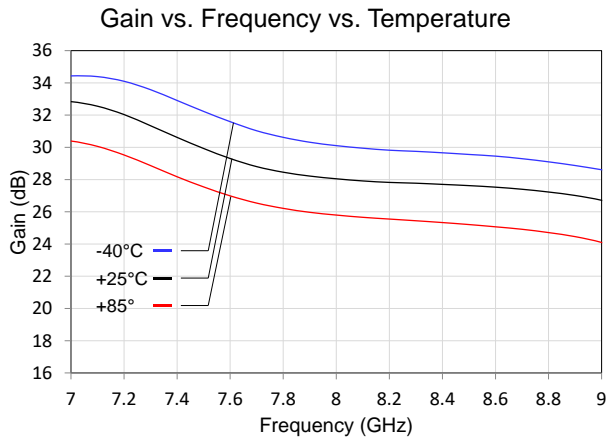

Pin Configuration and Description

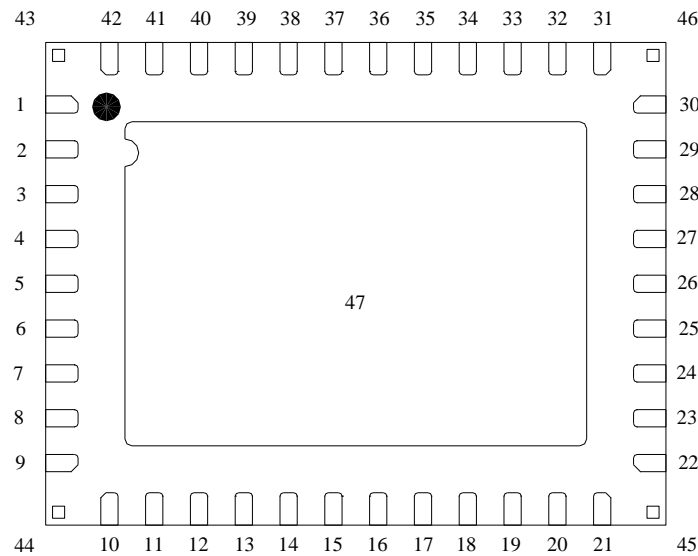

Top View

Pad No.	Label	Description
1, 2, 3, 4, 6, 7, 8, 9, 11, 13, 15, 16, 17, 18, 19, 21, 22, 23, 24, 25, 27, 28, 29, 33, 34, 35, 37, 39, 41	NC	No internal connection; can be grounded on PCB.
5	RF IN	RF Input, matched to 50 Ω, AC Coupled.
10, 42	V _{G12}	Gate voltage. Bias network is required; can be biased from either pin, and non-biased pin can be left open; see Application Circuit on page 11 as an example.
12, 40	V _{D1}	Drain voltage; must be biased from both sides. Bias network is required; see Application Circuit on page 11 as an example.
14, 38	V _{D2}	Drain voltage; must be biased from both sides. Bias network is required; see Application Circuit on page 11 as an example.
20, 32	V _{D3}	Drain voltage; must be biased from both sides. Bias network is required; see Application Circuit on page 11 as an example.
26	RF OUT	RF Output, matched to 50 ohms, AC Coupled.
30	V _{REF}	Reference diode output voltage.
31	V _{DET}	Detector diode output voltage. Varies with RF output power.
36	V _{G3}	Gate voltage. Bias network is required; see Application Circuit on page 11 as an example.
43, 44, 45, 46, 47	GND	Backside Paddle. Multiple vias should be employed to minimize inductance and thermal resistance; see Mounting Configuration on page 14 for suggested footprint.

Application Circuit

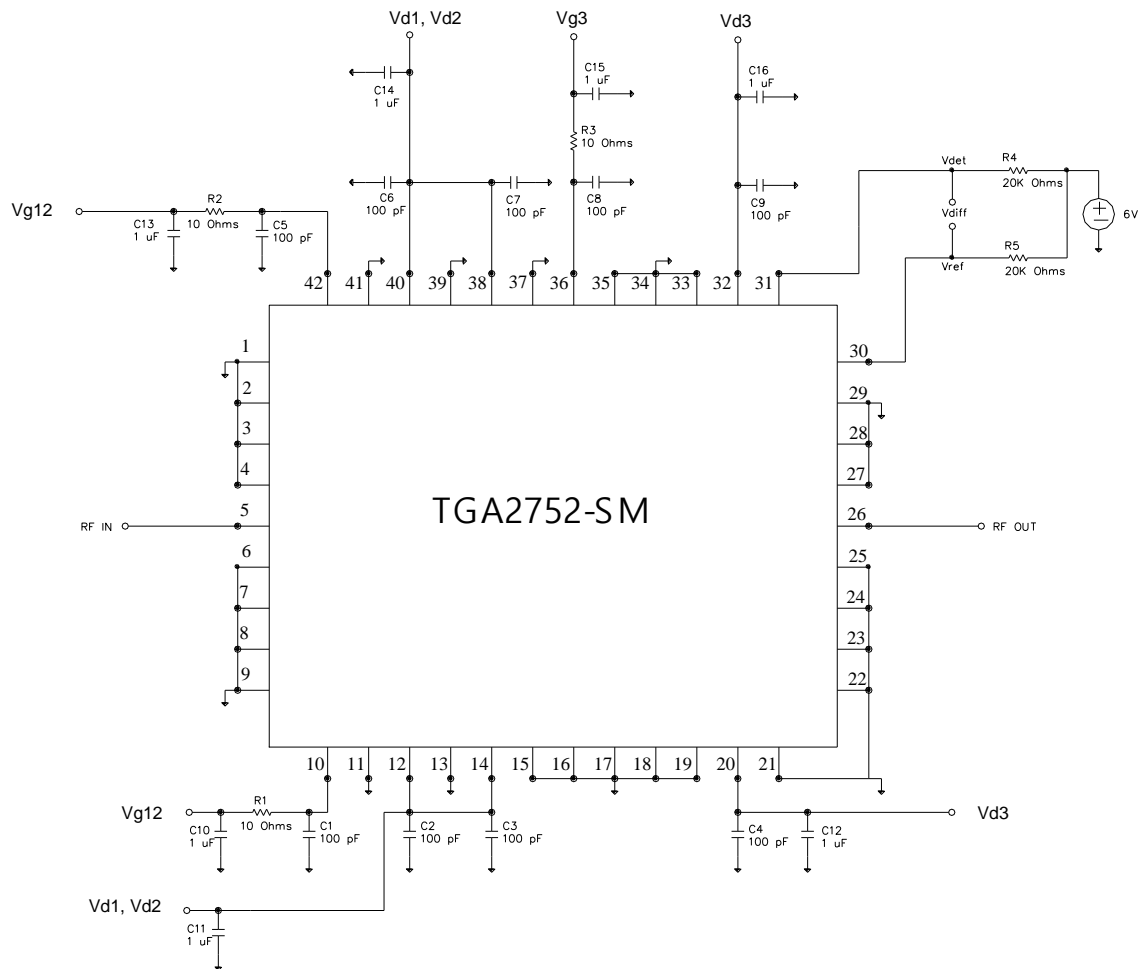

V_{G12} can be biased from either side, and the non-biased side can be left open.
 V_{D1} , V_{D2} , V_{D3} , must be biased from both sides.

Bias-up Procedure

- _____ V_{G12} set to -1.2 V
- _____ V_{G3} set to -3.5 V
- _____ V_{D1} , V_{D2} set to $+6\text{ V}$
- _____ V_{D3} sets to $+28\text{ V}$
- _____ Adjust V_{G12} more positive until quiescent I_D is 1000 mA
- _____ Adjust V_{G3} more positive until quiescent I_D is 190 mA
- _____ Apply RF signal

Bias-down Procedure

- _____ Turn off RF signal
- _____ Reduce V_{G12} to -1.2 V . Ensure $I_D \sim 0\text{ mA}$
- _____ Reduce V_{G3} to -3.5 V . Ensure $I_D \sim 0\text{ mA}$
- _____ Turn V_{D1} , V_{D2} , V_{D3} to 0 V
- _____ Turn V_{G12} , V_{G3} to 0 V

Application Evaluation Board

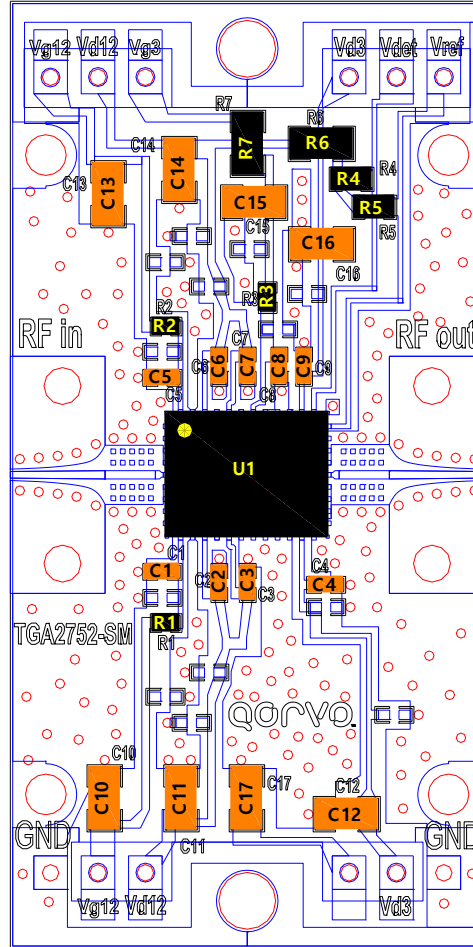

1. Board Material is RO4003 0.008" thickness with ½ oz. copper cladding

Bill of Material

Reference Des.	Value	Description	Manuf.	Part Number
n/a	n/a	Printed Circuit Board	Qorvo	
C1 – C9	100 pF	Cap, 0402, +50 V, 5%, COG	various	
C10 – C17	1 µF	Cap, 0603, +50 V, 5%, X5R	various	
R1 – R3	10 Ω	Res, 0402, 1/16W, 5%, SMD	various	
R4, R5	20 KΩ	Res, 0603, 1/16W, 5%, SMD	various	
R6, R7	0 Ω	Res, 0805, 1/16W, 5%, SMD	various	
U1		7.1 – 8.5 GHz Power Amplifier	Qorvo	TGA2752-SM

Package Marking and Dimensions

MARKING: PART NUMBER – TGA2752-SM
 LOT CODE – MXXXXXXX
 PACKAGE EXPOSED METALLIZATION IS GOLD PLATED
 PART IS OVERMOLD ENCAPSULATED

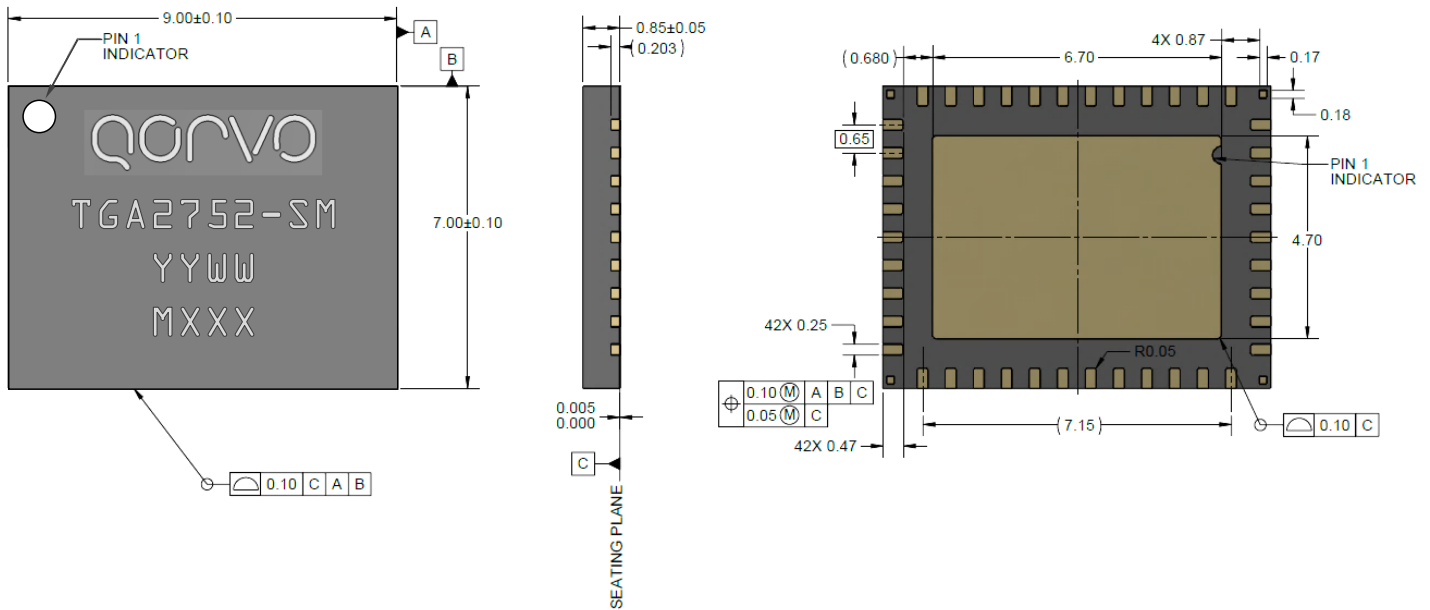

Notes:

1. All dimensions are in millimeters. Angles are in degrees.
2. This package is lead-free/RoHS-compliant with a copper alloy base (CDA194), and the plating material on the leads is Ni-Pd-Au. It is compatible with lead-free (maximum 260 °C reflow temperature) soldering process.

PCB Mounting Pattern

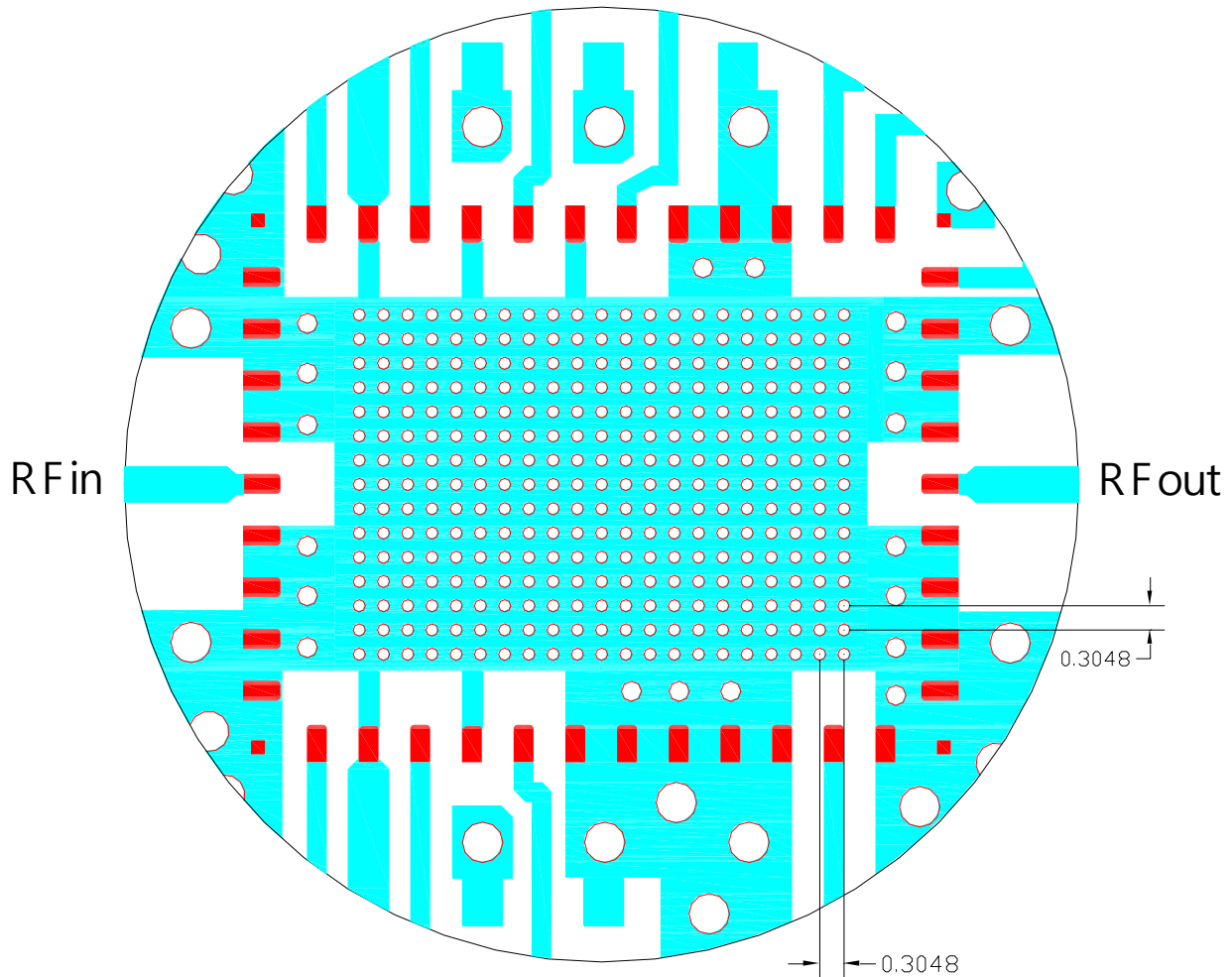

Notes:

1. The pad pattern shown has been developed and tested for optimized assembly at Qorvo. The PCB land pattern has been developed to accommodate lead and package tolerances. Since surface mount processes vary from company to company, careful process development is recommended.
2. Ground vias are critical for the proper performance of this device. Vias should have a final plated thru diameter of .1524 mm (.006”).
3. For best thermal performance, vias under the ground paddle should be copper filled.

Tape and Reel Information

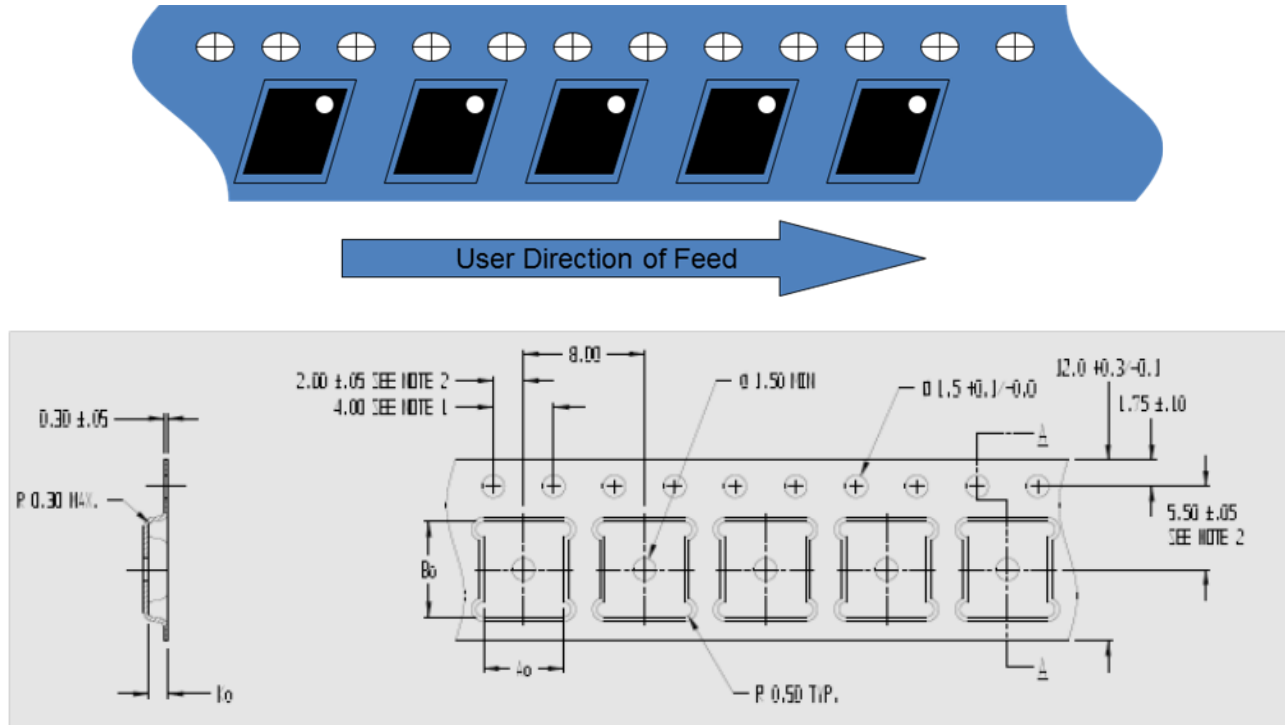

Feature	Measure	Symbol	Size (in)	Size (mm)
Cavity	Length	A0	0.366	9.3
	Width	B0	0.287	7.3
	Depth	K0	0.047	1.2
	Pitch	P1	0.472	12.0
Centerline Distance	Cavity to Perforation - Length Direction	P2	0.079	2.0
	Cavity to Perforation - Width Direction	F	0.217	5.50
Cover Tape	Width	C	0.362	9.20
Carrier Tape	Width	W	0.630	16.0

Notes:

1. Empty part cavities at the trailing and leading ends are sealed with cover tape. See EIA 481-1-A.
2. Labels are placed on the flange opposite the sprockets in the carrier tape.

Handling Precautions

Parameter	Rating	Standard
ESD – Human Body Model (HBM)	Class 1A	ESDA / JEDEC JS-001
ESD – Charged Device Model (CDM)	Class C1	JEDEC JESD22-C10
MSL – Moisture Sensitivity Level	Level 3	IPC/JEDEC J-STD-020



Caution!
ESD-Sensitive Device

Solderability

Compatible with both lead-free (260°C max. reflow temp.) and tin/lead (245°C max. reflow temp.) soldering processes.

RoHS Compliance

This part is compliant with 2011/65/EU RoHS directive (Restrictions on the Use of Certain Hazardous Substances in Electrical and Electronic Equipment) as amended by Directive 2015/863/EU.

This product also has the following attributes:

- Lead Free
- Halogen Free (Chlorine, Bromine)
- Antimony Free
- TBBP-A (C₁₅H₁₂Br₄O₂) Free
- PFOS Free
- SVHC Free

Contact Information

For the latest specifications, additional product information, worldwide sales and distribution locations:

Web: www.qorvo.com

Tel: 1-844-890-8163

Email: customer.support@qorvo.com

Important Notice

The information contained herein is believed to be reliable; however, Qorvo makes no warranties regarding the information contained herein and assumes no responsibility or liability whatsoever for the use of the information contained herein. All information contained herein is subject to change without notice. Customers should obtain and verify the latest relevant information before placing orders for Qorvo products. The information contained herein or any use of such information does not grant, explicitly or implicitly, to any party any patent rights, licenses, or any other intellectual property rights, whether with regard to such information itself or anything described by such information. **THIS INFORMATION DOES NOT CONSTITUTE A WARRANTY WITH RESPECT TO THE PRODUCTS DESCRIBED HEREIN, AND QORVO HEREBY DISCLAIMS ANY AND ALL WARRANTIES WITH RESPECT TO SUCH PRODUCTS WHETHER EXPRESS OR IMPLIED BY LAW, COURSE OF DEALING, COURSE OF PERFORMANCE, USAGE OF TRADE OR OTHERWISE, INCLUDING THE IMPLIED WARRANTIES OF MERCHANTABILITY AND FITNESS FOR A PARTICULAR PURPOSE.**

Without limiting the generality of the foregoing, Qorvo products are not warranted or authorized for use as critical components in medical, life-saving, or life-sustaining applications, or other applications where a failure would reasonably be expected to cause severe personal injury or death.

© 2020 Qorvo US, Inc. All rights reserved. This document is subject to copyright laws in various jurisdictions worldwide and may not be reproduced or distributed, in whole or in part, without the express written consent of Qorvo US, Inc.

Mouser Electronics

Authorized Distributor

Click to View Pricing, Inventory, Delivery & Lifecycle Information:

[Qorvo:](#)

[TGA2752-SM](#) [TGA2752-SMT](#)