

Product Overview

The Qorvo T1G4020036-FL is a 2 x 200 W (P_{3dB}) discrete GaN on SiC HEMT which operates from DC to 3.5 GHz. The device is in an industry standard air cavity package and is ideally suited for IFF, avionics, military and civilian radar, and test instrumentation. The device can support both pulsed and linear operations.

Lead-free and ROHS compliant

Evaluation boards are available upon request.



4-lead NI-650 Package (Eared)

Functional Block Diagram

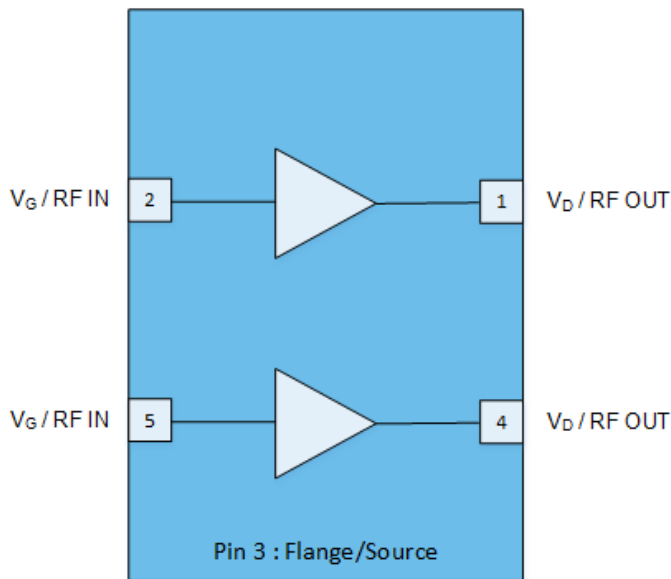

Key Features

- Frequency: DC to 3.5 GHz
 - Output Power (P_{3dB})¹: 200 W
 - Linear Gain¹: 18.1 dB
 - Typical PAE_{3dB}¹: 67.6%
 - Operating Voltage: 50 V
 - CW and Pulse capable
- Note 1: @ 2.8 GHz Load Pull (Half of device)

Applications

- Military and civilian radar
- Professional and military radio communications
- Test instrumentation
- Wideband or narrowband amplifiers
- Jammers

Ordering info

Part No.	Description
T1G4020036-FL	DC–3.5GHz, 50 V, 200 W GaN RF Transistor, Eared
T1G4020036-FL-EVB1	2.9 – 3.3 GHz EVB

Absolute Maximum Ratings ¹

Parameter	Rating	Units
Breakdown Voltage, BV_{DG}	+145	V
Gate Voltage Range, V_G	-7 to +2	V
Drain Current, $I_{D_{MAX}}$	24	A
Power Dissipation, CW, P_{DISS}	236	W
RF Input Power, CW, $T = 25^\circ\text{C}$	+47.5	dBm
Channel Temperature, T_{CH}	275	$^\circ\text{C}$
Mounting Temperature (30 Seconds)	320	$^\circ\text{C}$
Storage Temperature	-65 to +150	$^\circ\text{C}$

Notes:

1. Operation of this device outside the parameter ranges given above may cause permanent damage.

Recommended Operating Conditions ¹

Parameter	Min	Typ	Max	Units
Operating Temp. Range	-40	+25	+85	$^\circ\text{C}$
Drain Voltage Range, V_D	+32	+50	+55	V
Drain Bias Current, I_{DQ}	-	520	-	mA
Drain Current, I_D^4	-	12	-	A
Gate Voltage, V_G^3	-	-2.8	-	V
Channel Temperature (T_{CH})	-	-	250	$^\circ\text{C}$
Power Dissipation (P_D) ^{2,4}	-	-	374	W
Power Dissipation (P_D), CW ²	-	-	211	W

Notes:

1. Electrical performance is measured under conditions noted in the electrical specifications table. Specifications are not guaranteed over all recommended operating conditions.
2. Package base at 85°C
3. To be adjusted to desired I_{DQ}
4. Pulsed, 100us PW, 20% DC

Measured Load Pull Performance – Power Tuned ¹

Parameter	Typical Values				Units
	2.4	2.8	3.2	3.6	
Frequency, F	2.4	2.8	3.2	3.6	GHz
Output Power at 3dB compression, P_{3dB}	53.1	53.0	52.8	52.9	dBm
Power Added Efficiency at 3dB compression, PAE_{3dB}	54.1	54.7	57.5	54.9	%
Gain at 3dB compression, G_{3dB}	15.6	15.1	15.9	16.0	dB

Notes:

1. Test conditions unless otherwise noted: $T_A = 25^\circ\text{C}$, $V_D = 50\text{ V}$, $I_{DQ} = 260\text{ mA}$ (half device)
2. Pulsed, 100 us Pulse Width, 10% Duty Cycle.

Measured Load Pull Performance – Efficiency Tuned ¹

Parameter	Typical Values				Units
	2.4	2.8	3.2	3.6	
Frequency, F	2.4	2.8	3.2	3.6	GHz
Output Power at 3dB compression, P_{3dB}	50.1	50.2	50.5	50.5	dBm
Power Added Efficiency at 3dB compression, PAE_{3dB}	72.9	67.6	66.5	65.8	%
Gain at 3dB compression, G_{3dB}	17.5	18.4	17.4	18.1	dB

Notes:

1. Test conditions unless otherwise noted: $T_A = 25^\circ\text{C}$, $V_D = 50\text{ V}$, $I_{DQ} = 260\text{ mA}$ (half device)
2. Pulsed, 100 us Pulse Width, 10% Duty Cycle.

RF Characterization – 2.9 – 3.3 GHz EVB Performance at 2.9 GHz ¹

Parameter	Min	Typ	Max	Units
Linear Gain, G_{LIN}	–	16.1	–	dB
Output Power at 3dB compression point, P3dB	162	190	–	W
Drain Efficiency at 3dB compression point, DEFF3dB	40.0	47.0	–	%
Gain at 3dB compression point, G3dB	12.0	13.1	–	dB
Gate Leakage ² $V_D = +10\text{ V}$, $V_G = -3.8\text{ V}$	-63.4			mA

Notes:

1. $V_D = +36\text{ V}$, $I_{DQ} = 520\text{ mA}$ (combined), Temp = +25 °C, Pulse Width = 100 us, Duty Cycle = 20%
2. Gate leakage per path

RF Characterization – Mismatch Ruggedness at 2.9 GHz ^{1, 2, 3}

Symbol	Parameter	dB Compression	Typical
VSWR	Impedance Mismatch Ruggedness	3	10:1

Notes:

1. Test conditions unless otherwise noted: $T_A = 25\text{ °C}$, $V_D = 36\text{ V}$, $I_{DQ} = 520\text{ mA}$ (combined)
2. Input drive power is determined at pulsed 3dB compression under matched condition at EVB output connector.
3. Pulse: 100us, 20% Duty cycle.

Measured Load-Pull Smith Charts 1, 2, 3

Notes:

1. Test Conditions: $V_D = 50\text{ V}$, $I_{DQ} = 260\text{ mA}$, 100 us Pulse Width, 10% Duty Cycle, Temp = 25°C.
2. The performance shown below is for only half of the device out of the two independent amplification paths.
3. See page 15 for load pull reference planes where the performance was measured.

2.4GHz, Load-pull

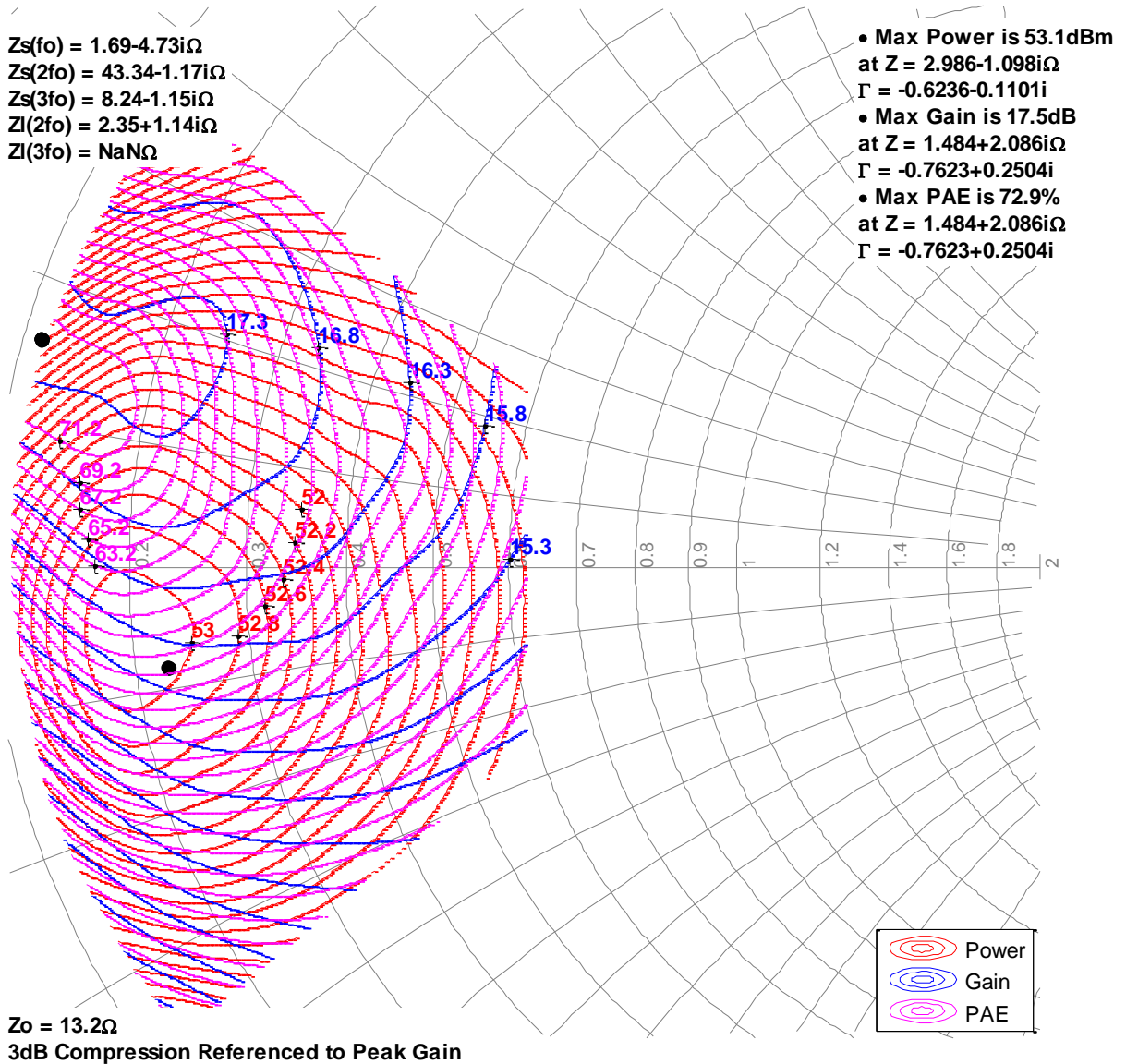

Measured Load-Pull Smith Charts 1, 2, 3

Notes:

1. Test Conditions: $V_D = 50\text{ V}$, $I_{DQ} = 260\text{ mA}$, 100 us Pulse Width, 10% Duty Cycle, Temp = 25°C.
2. The performance shown below is for only half of the device out of the two independent amplification paths.
3. See page 15 for load pull reference planes where the performance was measured.

2.8GHz, Load-pull

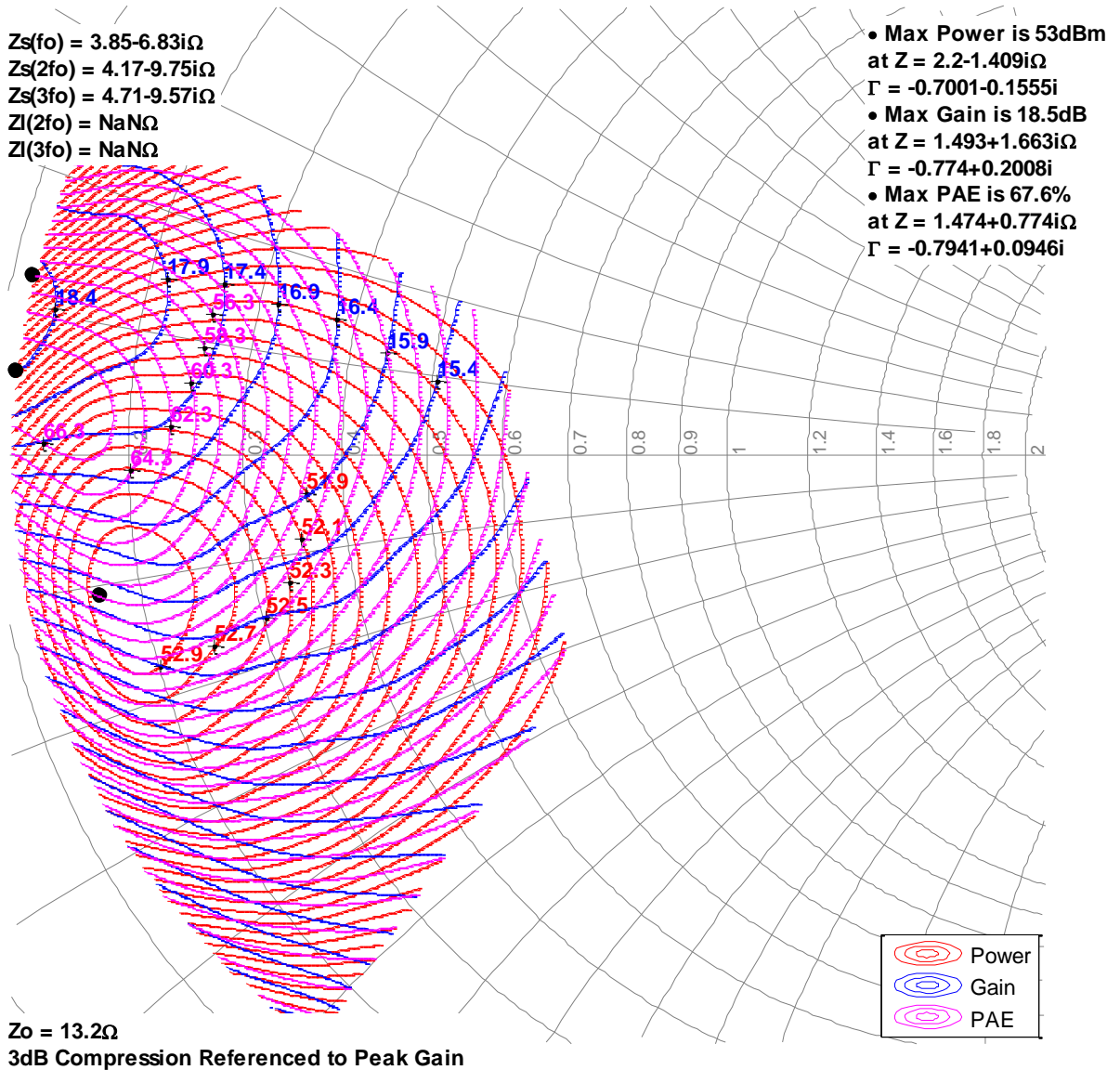

Measured Load-Pull Smith Charts 1, 2, 3

Notes:

1. Test Conditions: $V_D = 50\text{ V}$, $I_{DQ} = 260\text{ mA}$, 100 us Pulse Width, 10% Duty Cycle, Temp = 25°C.
2. The performance shown below is for only half of the device out of the two independent amplification paths.
3. See page 15 for load pull reference planes where the performance was measured.

3.2GHz, Load-pull

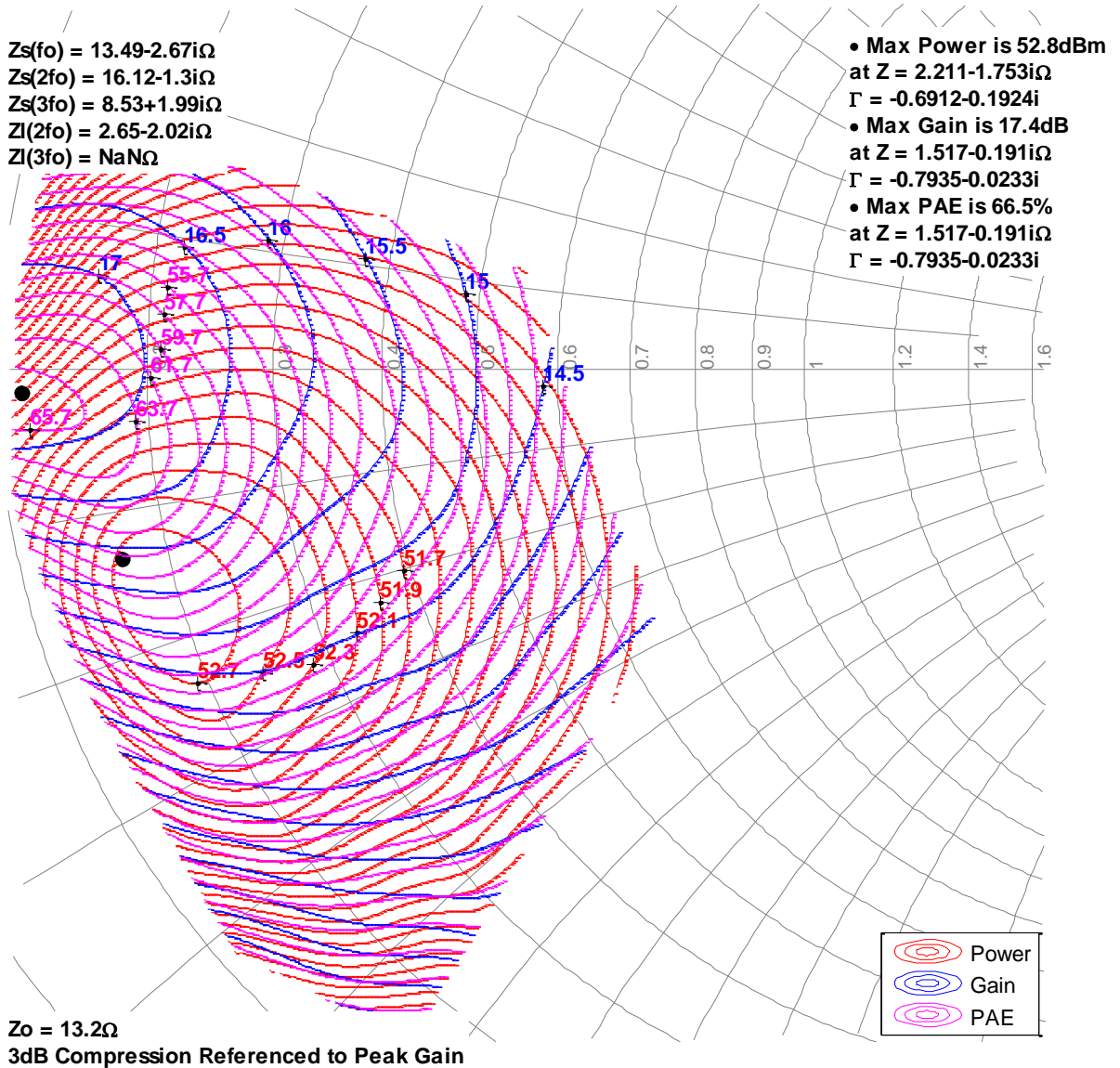

Measured Load-Pull Smith Charts 1, 2, 3

Notes:

1. Test Conditions: $V_D = 50\text{ V}$, $I_{DQ} = 260\text{ mA}$, 100 us Pulse Width, 10% Duty Cycle, Temp = 25°C.
2. The performance shown below is for only half of the device out of the two independent amplification paths.
3. See page 15 for load pull reference planes where the performance was measured.

3.6GHz, Load-pull

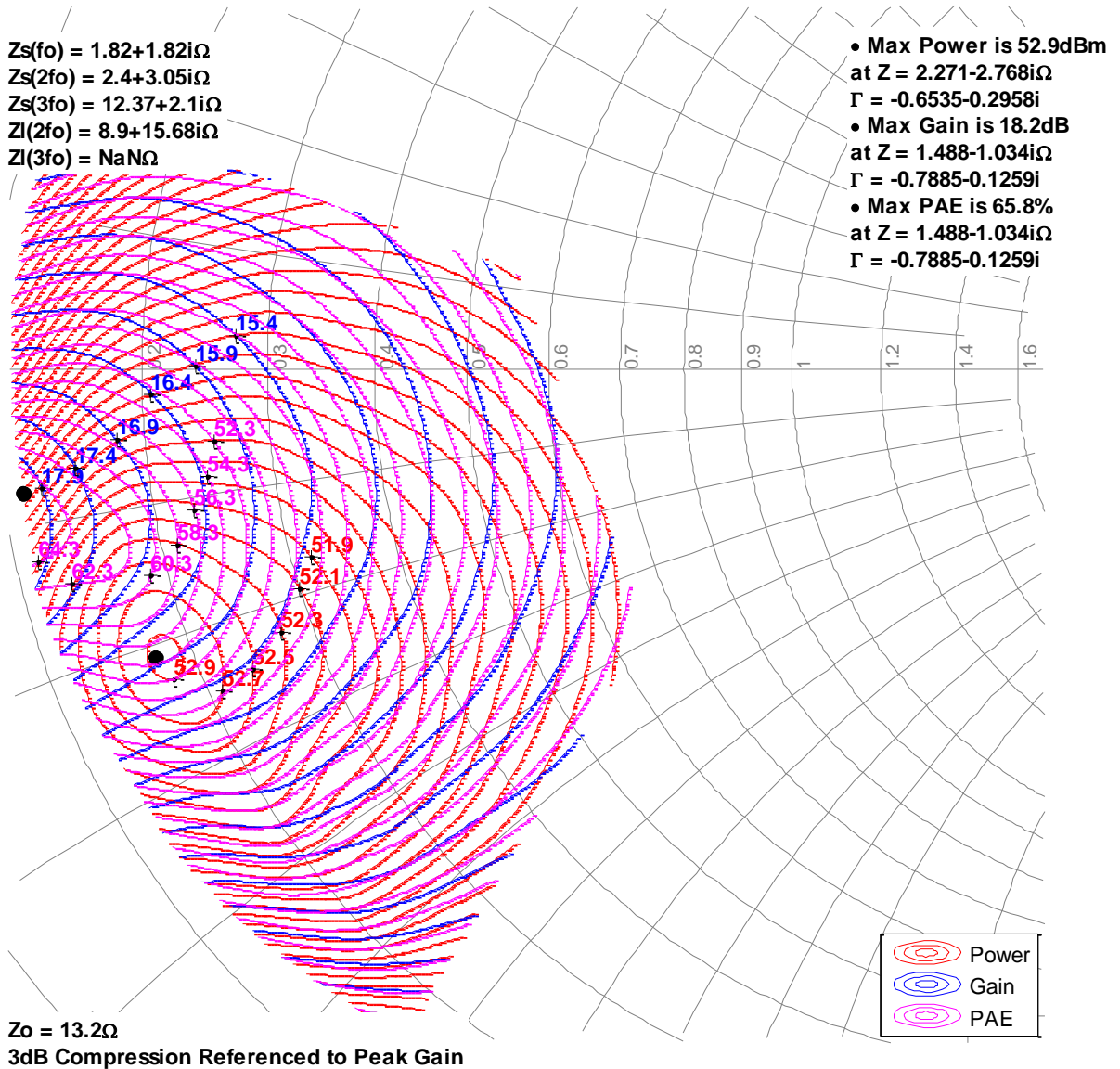

Typical Measured Performance – Load-Pull Drive-up ^{1,2}

Notes:

1. Test Conditions: $V_D = 50\text{ V}$, $I_{DQ} = 260\text{ mA}$, 100 us Pulse Width, 10% Duty Cycle, Temp = 25°C.
2. The performance shown below is for only half of the device out of the two independent amplification paths.
3. See page 15 for load pull reference planes where the performance was measured.

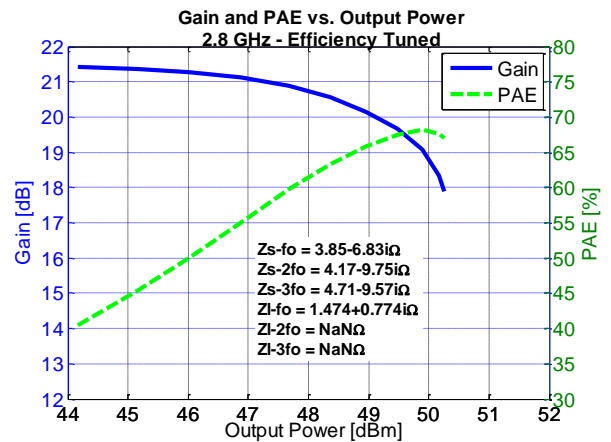
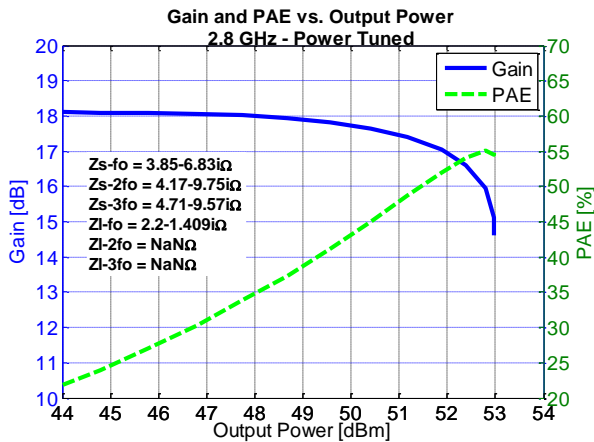
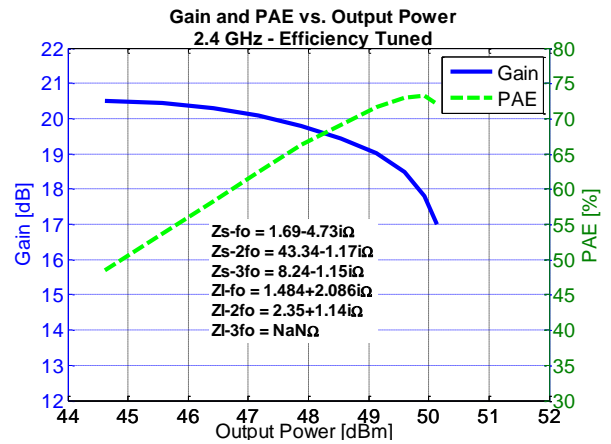
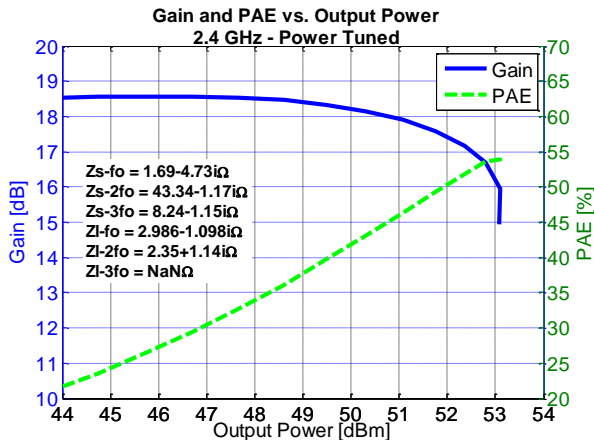

Typical Measured Performance – Load-Pull Drive-up ^{1,2}

Notes:

1. Test Conditions: $V_D = 50\text{ V}$, $I_{DQ} = 260\text{ mA}$, 100 us Pulse Width, 10% Duty Cycle, Temp = 25°C.
2. The performance shown below is for only half of the device out of the two independent amplification paths.
3. See page 15 for load pull reference planes where the performance was measured.

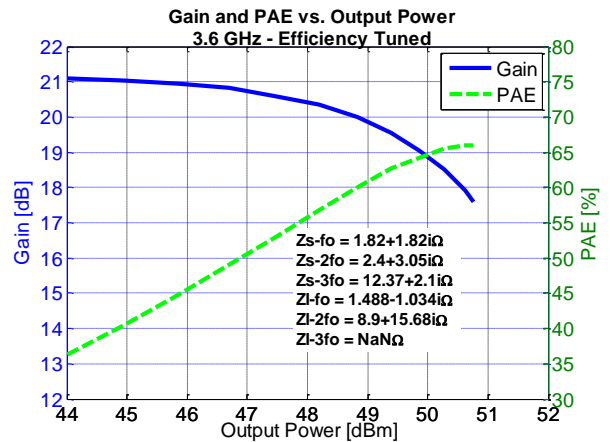
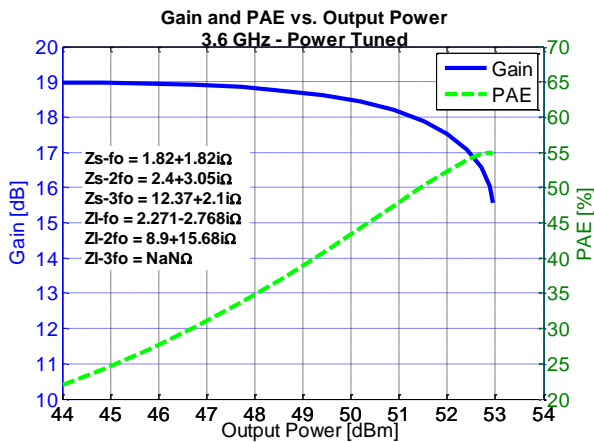
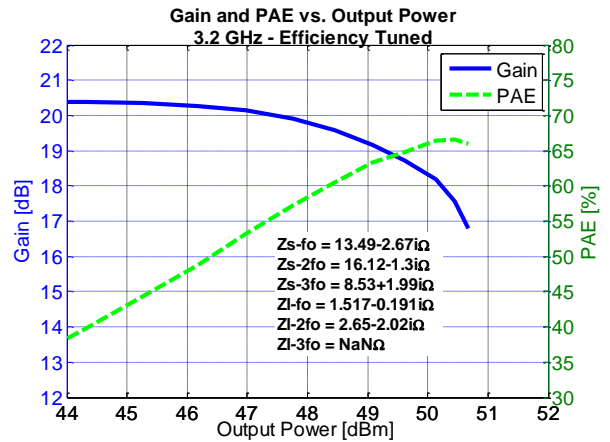
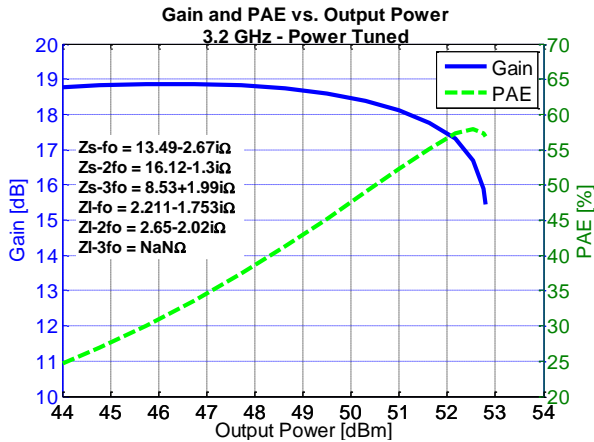

Power Driveup Performance Over Temperatures Of 2.9 – 3.3 GHz EVB ¹

Notes:

1. Test Conditions: $V_D = 36\text{ V}$, $I_{DQ} = 520\text{ mA}$, 100 us Pulse Width, 20% Duty Cycle.

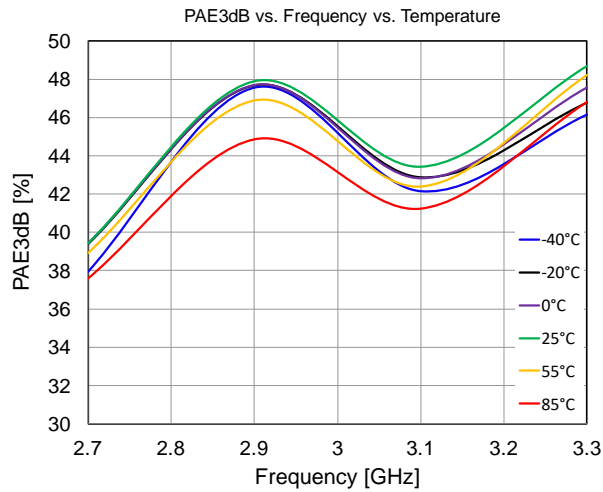
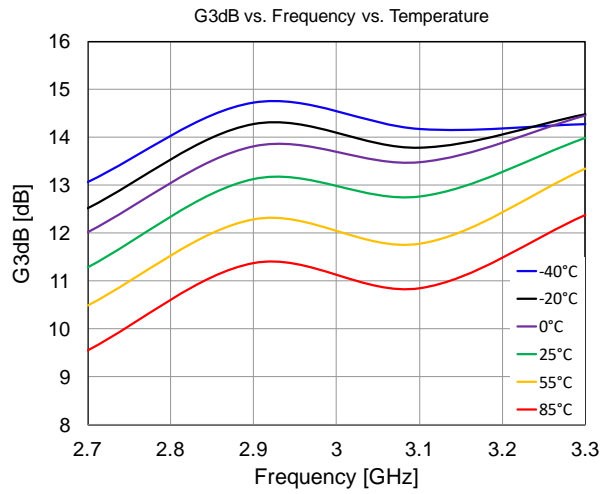
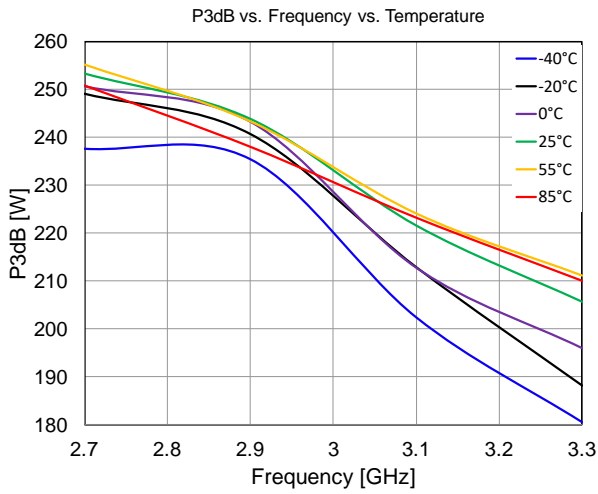

Power Driveup Performance At 25°C Of 2.9 – 3.3 GHz EVB ¹

Notes:

1. Test Conditions: $V_D = 36\text{ V}$, $I_{DQ} = 520\text{ mA}$, 20 us Pulse Width, 20% Duty Cycle.

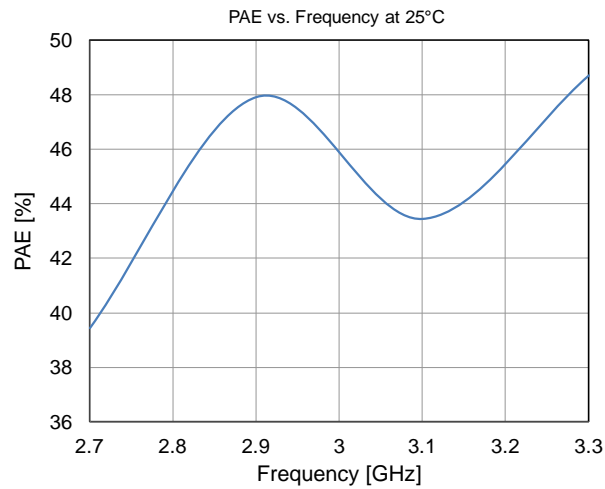
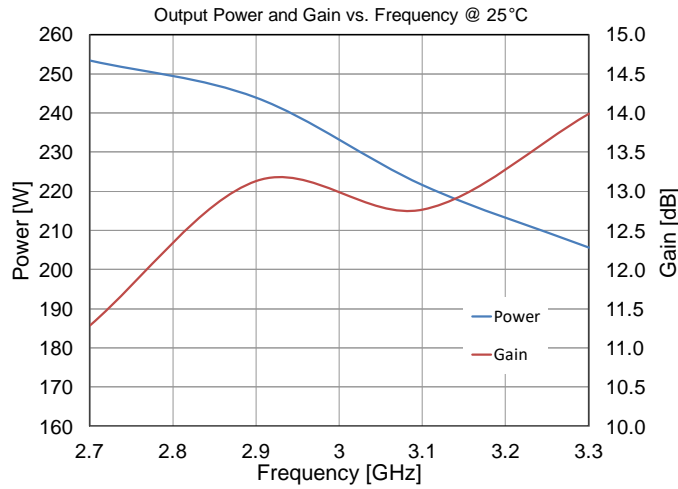

Thermal and Reliability Information - CW ⁽¹⁾

Parameter	Test Conditions	Value	Units
Thermal Resistance, Peak IR Surface Temperature at Average Power (θ_{JC})	$P_{DISS} = 288\text{ W}$, $T_{baseplate} = 85^\circ\text{C}$	0.58	$^\circ\text{C/W}$
Channel Temperature, T_{CH}		253	$^\circ\text{C}$
Thermal Resistance, Peak IR Surface Temperature at Average Power (θ_{JC})	$P_{DISS} = 230\text{ W}$, $T_{baseplate} = 85^\circ\text{C}$	0.56	$^\circ\text{C/W}$
Channel Temperature, T_{CH}		213	$^\circ\text{C}$
Thermal Resistance, Peak IR Surface Temperature at Average Power (θ_{JC})	$P_{DISS} = 173\text{ W}$, $T_{baseplate} = 85^\circ\text{C}$	0.52	$^\circ\text{C/W}$
Channel Temperature, T_{CH}		175	$^\circ\text{C}$
Thermal Resistance, Peak IR Surface Temperature at Average Power (θ_{JC})	$P_{DISS} = 115\text{ W}$, $T_{baseplate} = 85^\circ\text{C}$	0.50	$^\circ\text{C/W}$
Channel Temperature, T_{CH}		142	$^\circ\text{C}$

Notes:

1. Based on expected carrier amplifier efficiency of Doherty.
2. P_{OUT} assumes 25% peaking amplifier contribution of total average Doherty rated power.
3. Thermal resistance is measured to package backside.
4. Refer to the following document: [GaN Device Channel Temperature, Thermal Resistance, and Reliability Estimates](#)

Thermal and Reliability Information - Pulsed ⁽¹⁾

Parameter	Test Conditions	Value	Units
Thermal Resistance, Peak IR Surface Temperature at Average Power (θ_{JC})	$P_{DISS} = 230.4\text{ W}$, $T_{baseplate} = 85^\circ\text{C}$ Pulse Width = 100 μS	0.35	$^\circ\text{C/W}$
Channel Temperature, T_{CH}		Duty Cycle = 5%	166
Thermal Resistance, Peak IR Surface Temperature at Average Power (θ_{JC})	$P_{DISS} = 230.4\text{ W}$, $T_{baseplate} = 85^\circ\text{C}$ Pulse Width = 100 μS	0.36	$^\circ\text{C/W}$
Channel Temperature, T_{CH}		Duty Cycle = 10%	168
Thermal Resistance, Peak IR Surface Temperature at Average Power (θ_{JC})	$P_{DISS} = 230.4\text{ W}$, $T_{baseplate} = 85^\circ\text{C}$ Pulse Width = 300 μS	0.38	$^\circ\text{C/W}$
Channel Temperature, T_{CH}		Duty Cycle = 20%	173
Thermal Resistance, Peak IR Surface Temperature at Average Power (θ_{JC})	$P_{DISS} = 230.4\text{ W}$, $T_{baseplate} = 85^\circ\text{C}$ Pulse Width = 300 μS	0.44	$^\circ\text{C/W}$
Channel Temperature, T_{CH}		Duty Cycle = 50%	187

Notes:

1. Based on expected carrier amplifier efficiency of Doherty.
2. P_{OUT} assumes 25% peaking amplifier contribution of total average Doherty rated power.
3. Thermal resistance is measured to package backside.
4. Refer to the following document: [GaN Device Channel Temperature, Thermal Resistance, and Reliability Estimates](#)

Pin Configuration and Description ¹

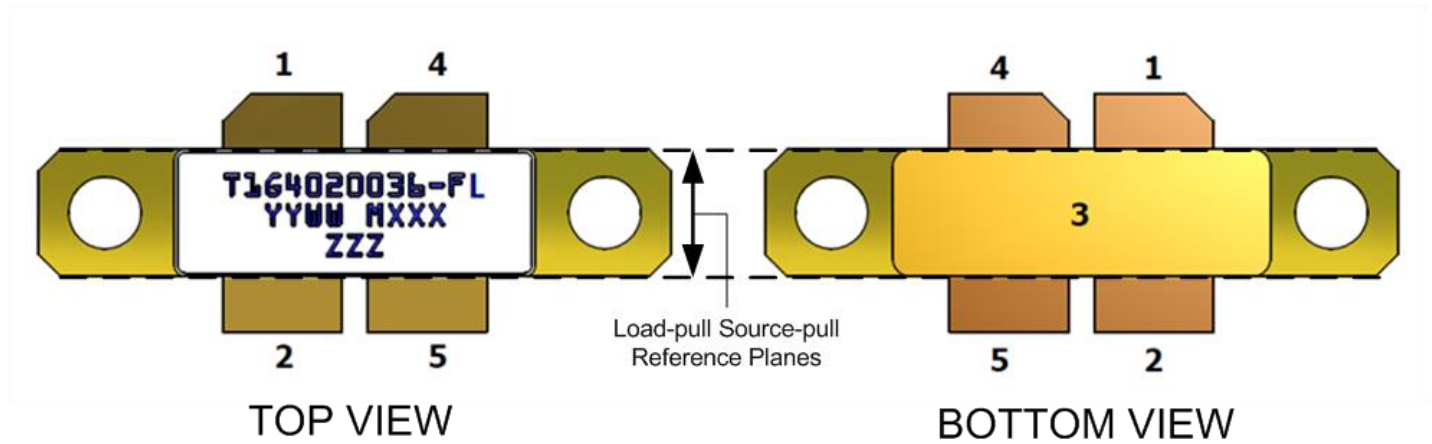

Note:

- 1- The T1G4020036-FS will be marked with the “20036” designator and a lot code marked below the part designator. The “YY” represents the last two digits of the calendar year the part was manufactured, the “WW” is the work week of the assembly lot start, the “MXXX” is the production lot number, and the “ZZZ” is an auto-generated serial number.

Pin	Symbol	Description
2, 5	RF IN / V_G	Gate
1, 4	RF OUT / V_D	Drain
3	Source	Source / Ground / Backside of part

Mechanical Drawing ¹

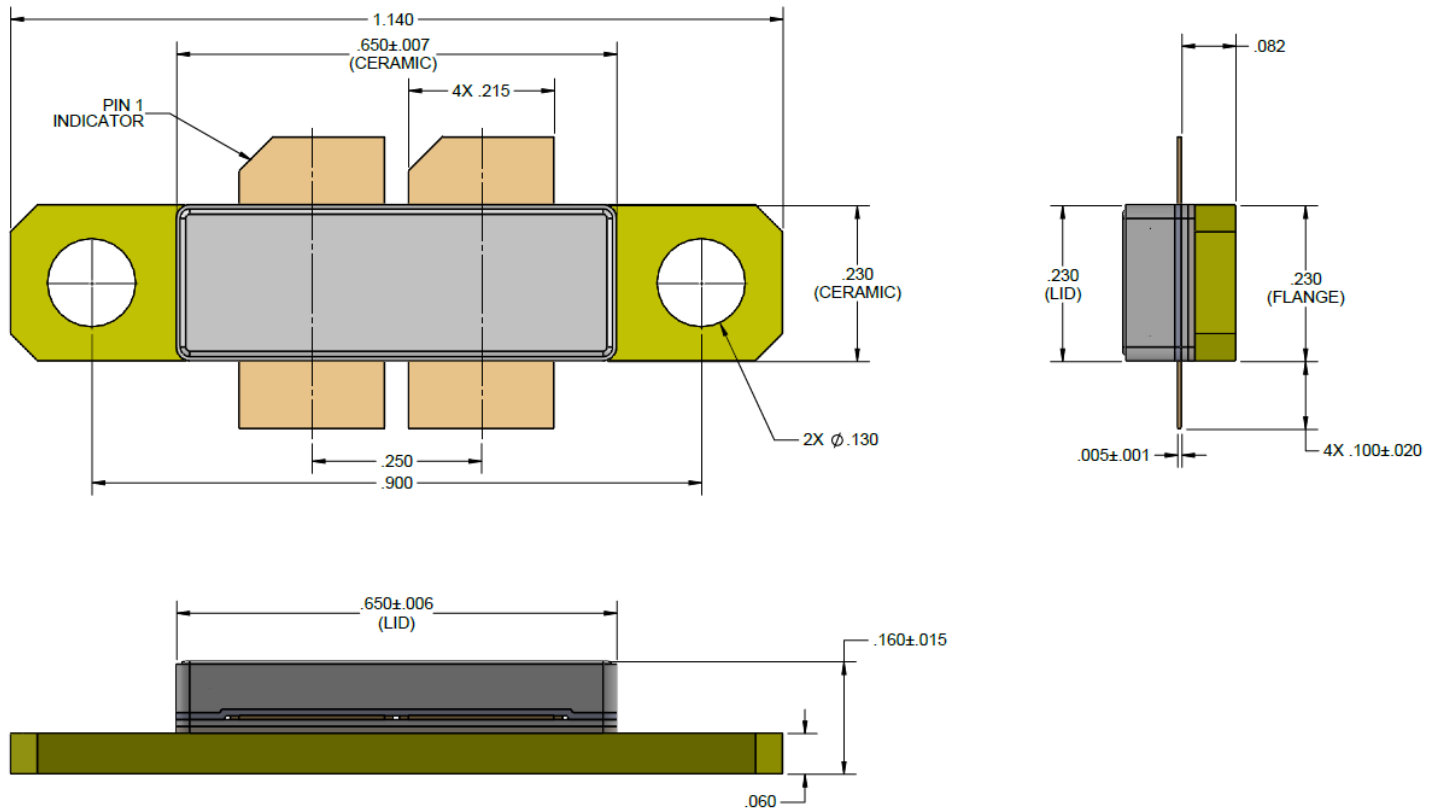

Note:

- 1- MATERIAL:
PACKAGE BASE: CERAMIC / METAL
PACKAGE LID: CERAMIC
- 2- ALL DIMENSIONS ARE IN INCHES. DIMENSION TOLERANCE IS ± 0.005 INCHES, UNLESS NOTED OTHERWISE.
- 3- PACKAGE METAL BASE AND LEADS ARE GOLD PLATED.
- 4- PART IS EPOXY SEALED.
- 5- PARTS MEETS INDUSTRY NI650 FOOTPRINT.+
- 6- BODY DIMENSIONS DO NOT INCLUDE EPOXY RUNOUT WHICH CAN BE UP TO $.020$ PER SIDE.

2.9 – 3.3 GHz Application Circuit - Schematic

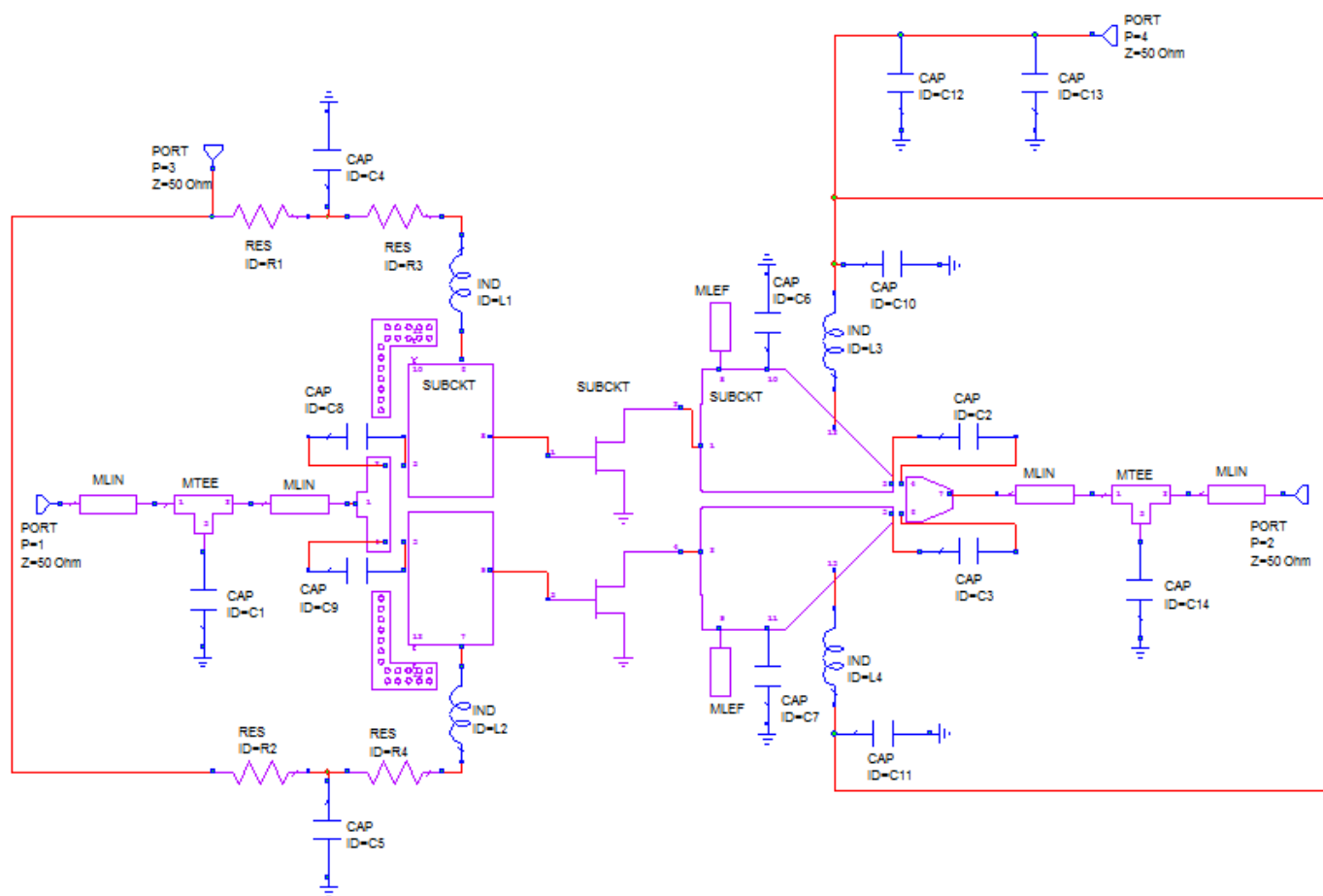

Bias-up Procedure	Bias-down Procedure
1. Set V_G to -5 V.	1. Turn off RF signal.
2. Set I_D current limit to 4 A.	2. Turn off V_D
3. Apply 36 V V_D .	3. Wait 2 seconds to allow drain capacitor to discharge.
4. Slowly adjust V_G until I_D is set to 520 mA.	4. Turn off V_G
5. Apply RF.	

2.9 – 3.3 GHz Application Circuit - Layout

PCB material is RO4350B 0.020" thick.

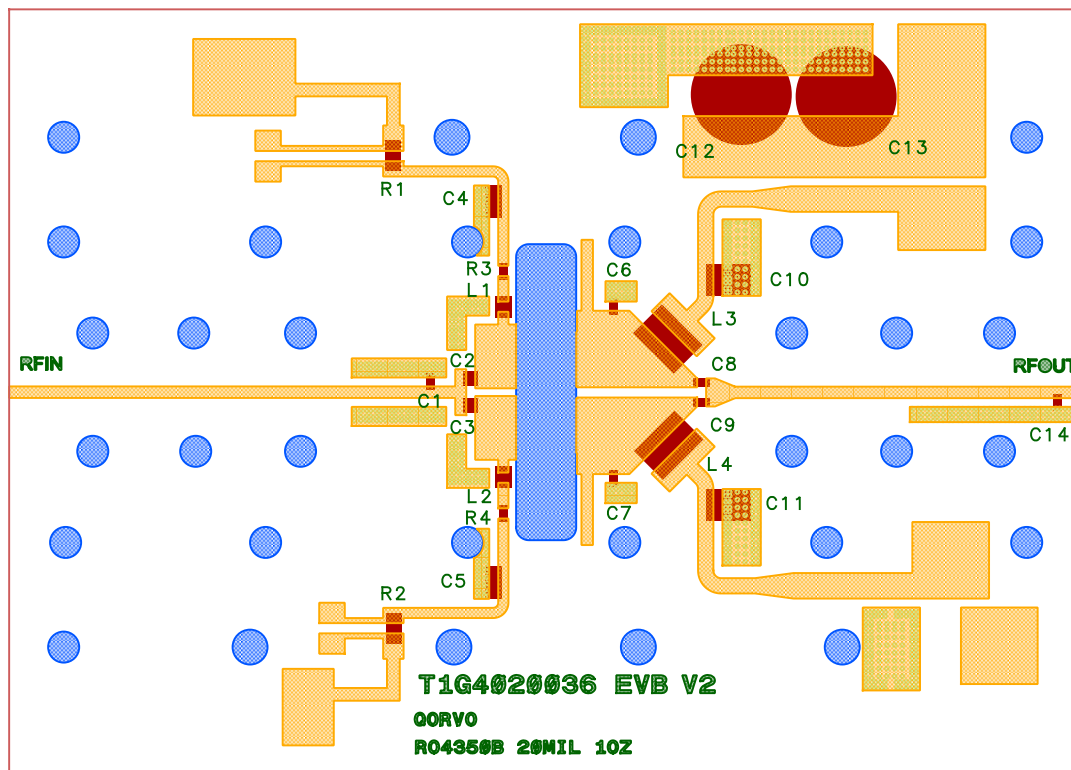

2.9 – 3.3 GHz Application Circuit – Bill of Material

Reference Design	Value	Qty	Manufacturer	Part Number
C4, C5	10uF, 6.3V	2	TDK	C1632X5R0J106M130AC
C10, C11	1uF, 100V	2	AVX	18121C105KAT2A
C12, C13	220uF, 50V	2	United Chemi-Con	EMVY500ADA221MJA0G
C2, C3	2.7pF	2	ATC	600F2R7AT250X
C8, C9	5.6pF	2	ATC	600S5R6AT250X
C1	1.6pF	1	ATC	600S1R6AT250X
C6, C7	0.5pF	2	ATC	600S0R5AT250X
C14	0.8pF	1	ATC	600S0R8AT250X
R3, R4	10Ohms	2	Vishay	CRCW060310R0FKEA
R1, R2	0.001Ohms	2	Stackpole Electronics	CSNL1206FT1L00
L1, L2	22nH	2	Coilcraft	0805CS-220X_E_
L3, L4	6.6nH	2	Coilcraft	GA3093-AL_
Connectors	SMA	2	Gigalane	1101055

Recommended Solder Temperature Profile

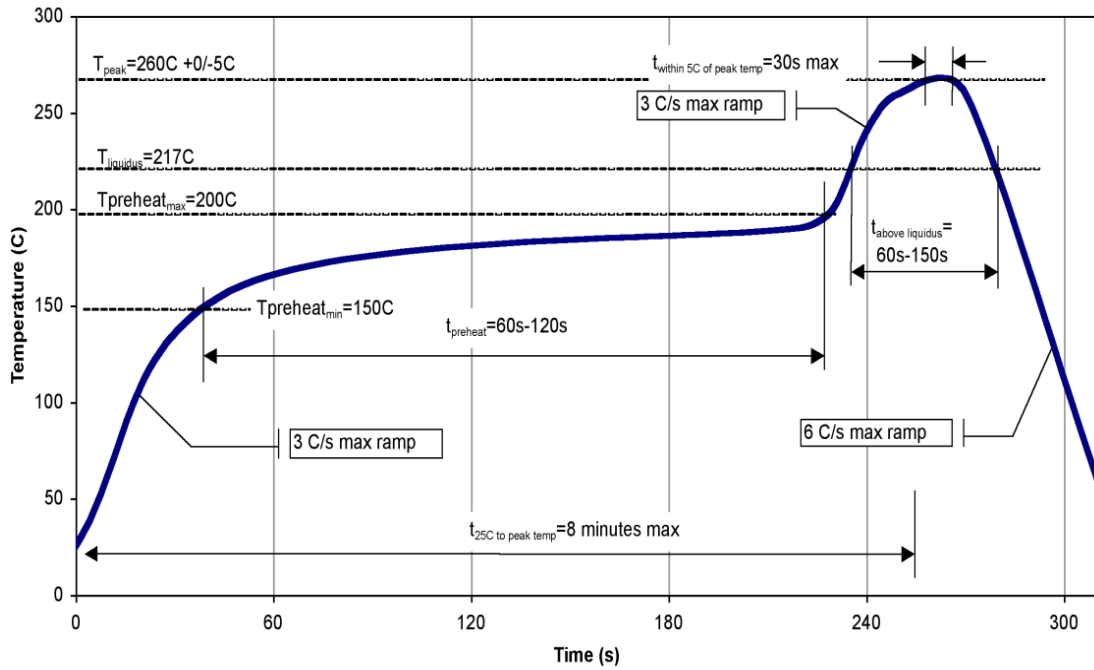

Handling Precautions

Parameter	Rating	Standard
ESD – Human Body Model (HBM)	Class 1B (950V)	JESD22-A114
ESD – Charged Device Model (CDM)	Class C3 (1000V)	JESD22-C101
MSL – Moisture Sensitivity Level	MSL3	IPC/JEDEC J-STD-020 (260°C Convection reflow)



Caution!
ESD-Sensitive Device

Solderability

Compatible with both lead-free (260°C max. reflow temp.) and tin/lead (245°C max. reflow temp.) soldering processes. Solder profiles available upon request.

Package lead plating is NiAu. Au thickness is minimum 60 µin.

RoHS Compliance

This part is compliant with 2011/65/EU RoHS directive (Restrictions on the Use of Certain Hazardous Substances in Electrical and Electronic Equipment) as amended by Directive 2015/863/EU.

This product also has the following attributes:

- Lead Free
- Halogen Free (Chlorine, Bromine)
- Antimony Free
- TBBP-A (C₁₅H₁₂Br₄O₂) Free
- PFOS Free
- SVHC Free



Contact Information

For the latest specifications, additional product information, worldwide sales and distribution locations:

Web: www.qorvo.com

Tel: 1-844-890-8163

Email: customer.support@qorvo.com

Important Notice

The information contained herein is believed to be reliable; however, Qorvo makes no warranties regarding the information contained herein and assumes no responsibility or liability whatsoever for the use of the information contained herein. All information contained herein is subject to change without notice. Customers should obtain and verify the latest relevant information before placing orders for Qorvo products. The information contained herein or any use of such information does not grant, explicitly or implicitly, to any party any patent rights, licenses, or any other intellectual property rights, whether with regard to such information itself or anything described by such information. **THIS INFORMATION DOES NOT CONSTITUTE A WARRANTY WITH RESPECT TO THE PRODUCTS DESCRIBED HEREIN, AND QORVO HEREBY DISCLAIMS ANY AND ALL WARRANTIES WITH RESPECT TO SUCH PRODUCTS WHETHER EXPRESS OR IMPLIED BY LAW, COURSE OF DEALING, COURSE OF PERFORMANCE, USAGE OF TRADE OR OTHERWISE, INCLUDING THE IMPLIED WARRANTIES OF MERCHANTABILITY AND FITNESS FOR A PARTICULAR PURPOSE.**

Without limiting the generality of the foregoing, Qorvo products are not warranted or authorized for use as critical components in medical, life-saving, or life-sustaining applications, or other applications where a failure would reasonably be expected to cause severe personal injury or death.

Copyright 2020 © Qorvo, Inc. | Qorvo is a registered trademark of Qorvo, Inc.

Mouser Electronics

Authorized Distributor

Click to View Pricing, Inventory, Delivery & Lifecycle Information:

[Qorvo:](#)

[T1G4020036-FS](#) [T1G4020036-FL](#) [T1G4020036-FL-EVB](#)