

## Product Overview

Qorvo's QPX0001 is a compact, wideband I/Q GaAs mixer housed in a 3.9 x 3.9 mm air cavity surface mount ceramic package. Operating over the 6 to 26 GHz bandwidth, the mixer can be configured as an image reject mixer, a single sideband upconverter, or a QPSK modulator/demodulator. The QPX0001 utilizes two double balanced mixer cells and a 90° hybrid internal to the MMIC. An external 90° IF hybrid is required to complete the image rejection or sideband suppression. The QPX0001 is a much smaller alternative to higher cost hybrid I/Q Mixers and single sideband upconverter assemblies.

## Functional Block Diagram

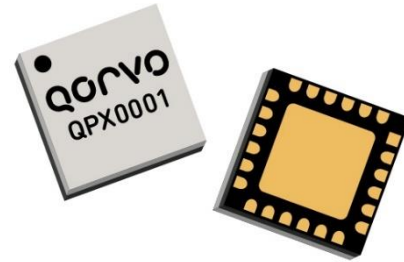
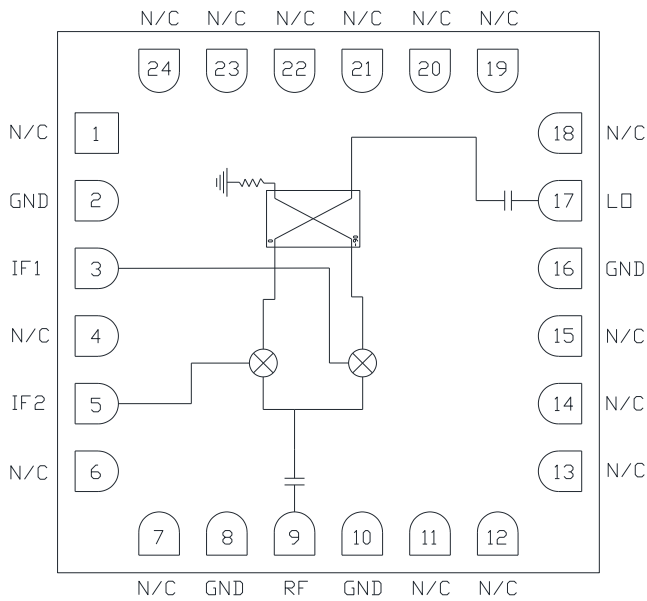

## Key Features

- I, Q outputs
- RF, LO Frequency Range: 6 – 26 GHz
- IF Frequency Range: DC – 3 GHz
- Low conversion loss of 8 dB at 14 GHz
- High image rejection of 25 dB
- High LO/RF isolation > 45 dB at 14 GHz
- Wide operating bandwidth
- Package Dimensions: 3.9 x 3.9 x 0.9 mm

*Performance is typical across frequency. Please reference electrical specification table and data plots for more details.*

## Applications

- Image reject downconversion
- Single-sideband modulation
- Low noise receiver systems
- Phase detection
- Electronic Warfare (EW)
- QPSK modulation/demodulation

## Ordering Information

Part No.	Description
QPX0001EVB1	Evaluation Board, Qty=1
QPX0001SR	Tape and Reel, Qty=100

## Absolute Maximum Ratings

Parameter	Rating
LO, RF, or IF power, CW, 25 °C	+25 dBm
Channel Temperature, T <sub>ch</sub>	150 °C
Operating Temperature	-40 to 85 °C
Storage Temperature	-55 to 150 °C
Mounting Temperature (30 sec)	260 °C

Exceeding any one or a combination of the Absolute Maximum Rating conditions may cause permanent damage to the device. Extended application of Absolute Maximum Rating conditions to the device may reduce device reliability.

## Recommended Operating Conditions

Parameter	Min	Typ.	Max	Units
LO Drive Power	+13	+17	+21	dBm
RF input Power (downconversion)			+17	dBm
IF Input Power (upconversion)			+17	dBm
Temperature Range	-40	+25	+85	°C

Electrical specifications are measured at specified test conditions. Specifications are not guaranteed over all recommended operating conditions.

## Electrical Specifications

Test conditions unless otherwise noted: 25 °C, IF = 100 MHz USB, LO = +17 dBm

Parameter	Min	Typ.	Max	Units
RF, LO Operational Frequency Range	6	–	26	GHz
IF Frequency Range	DC	–	3	GHz
Conversion Gain (with external 90° IF hybrid)	-13	-8	–	dB
Image Rejection (with external 90° IF hybrid)	–	25	–	dB
LO to RF Isolation	–	40	–	dB
LO to IF Isolation	–	27	–	dB
Input Power (P <sub>1dB</sub> )	–	+14	–	dBm
Input IP3	–	+21	–	dBm

Typical Performance – Data Taken as IRM with External IF Hybrid, IF=100 MHz USB

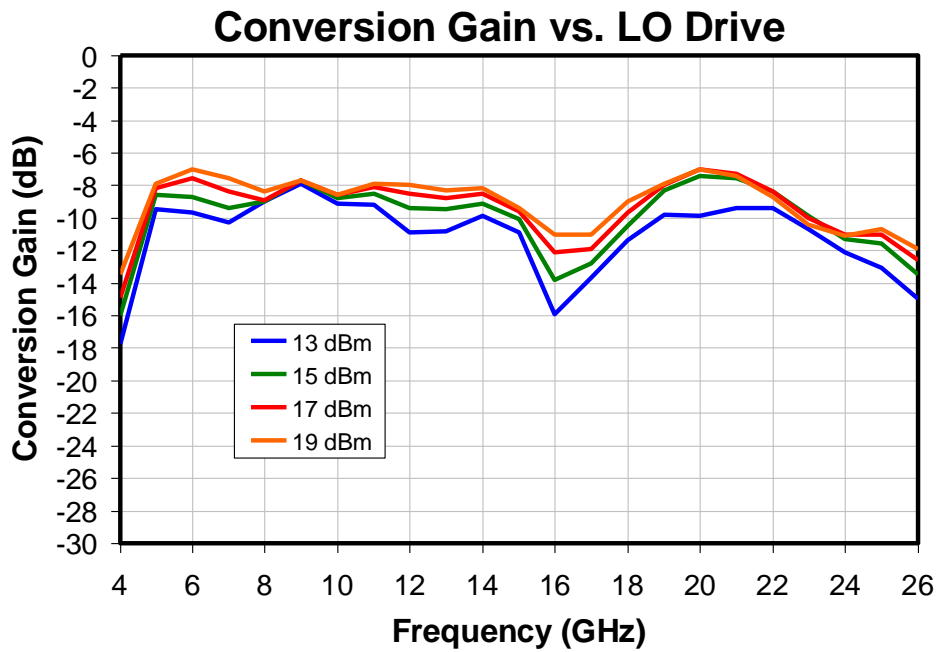
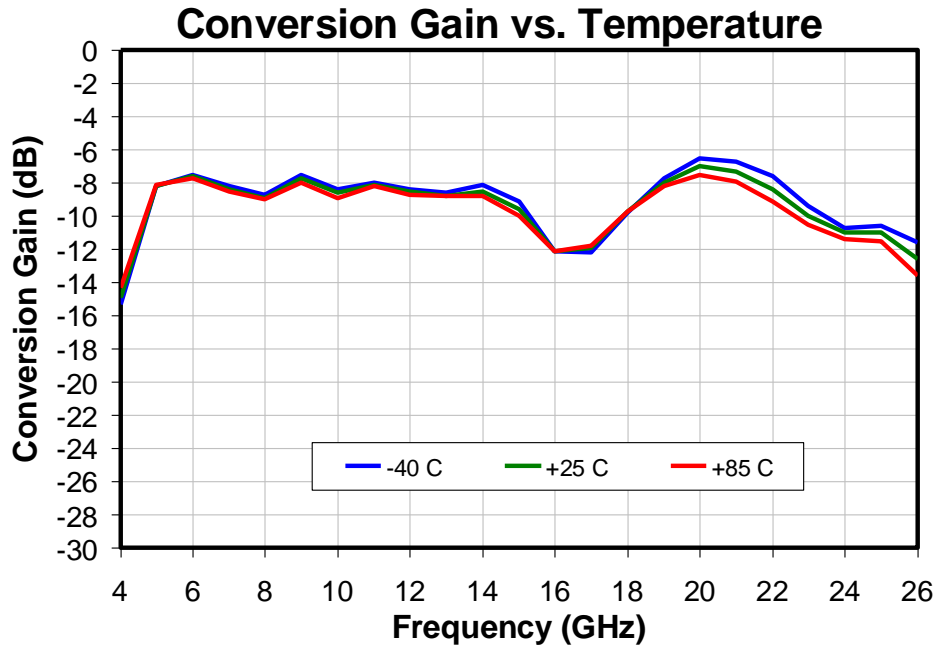

Typical Performance – Data Taken as IRM with External IF Hybrid, IF=100 MHz USB

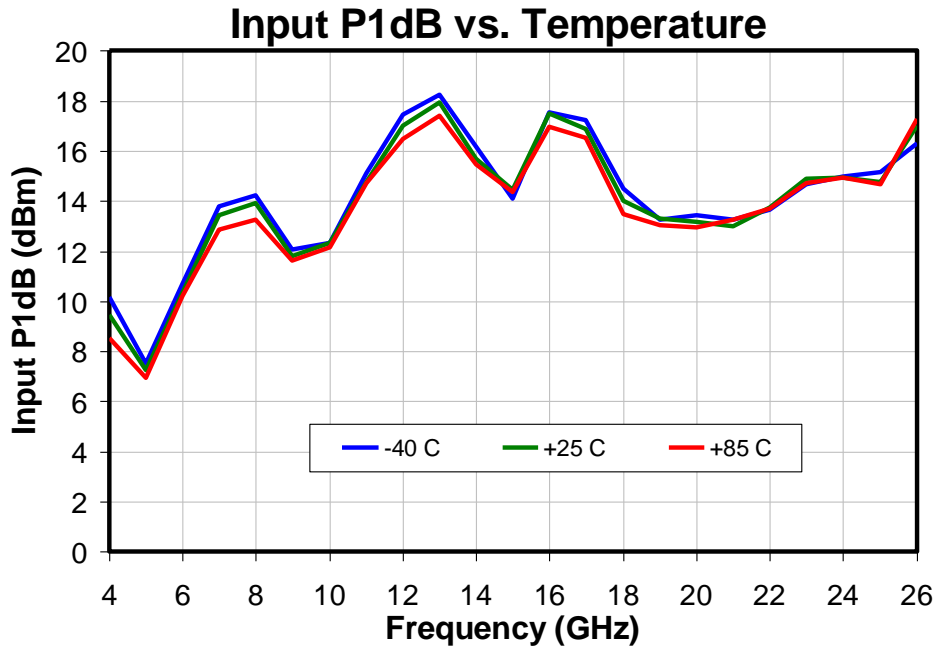
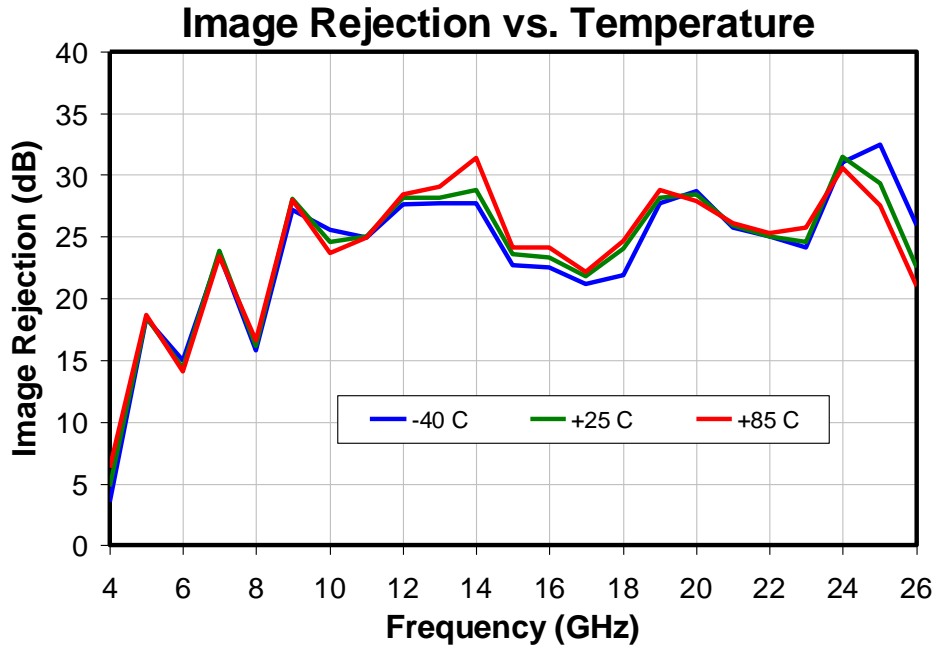

Typical Performance – Data Taken as IRM with External IF Hybrid, IF=100 MHz USB

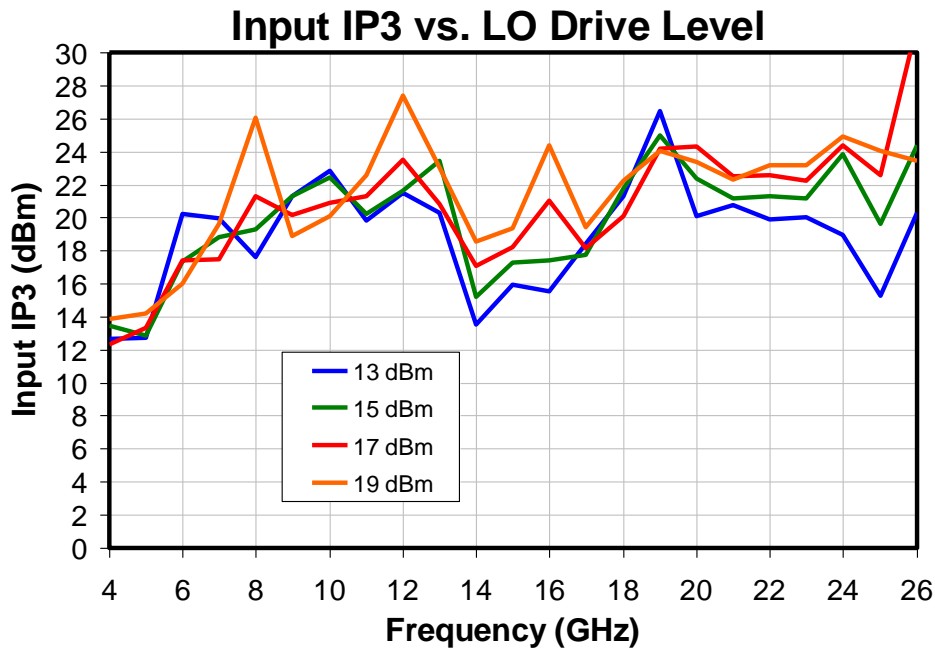
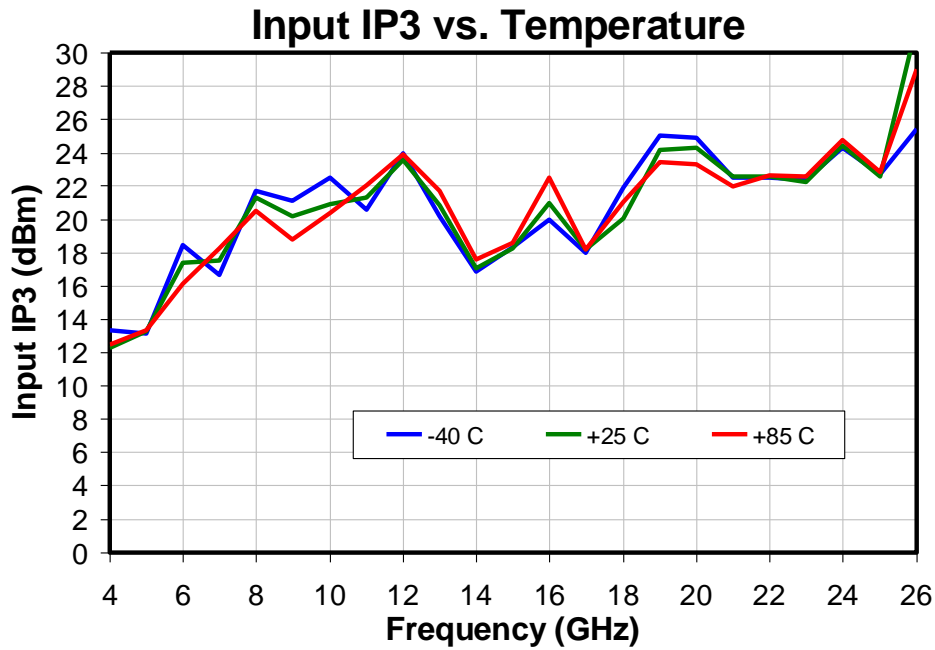

Typical Performance – Data Taken as Upconverter with External IF Hybrid, IF=950 MHz USB

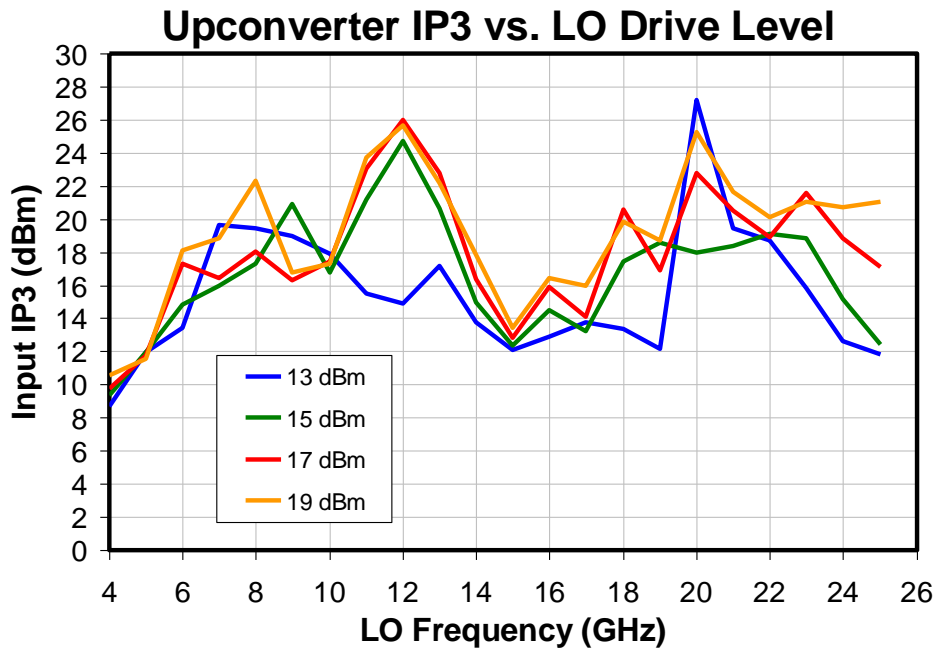
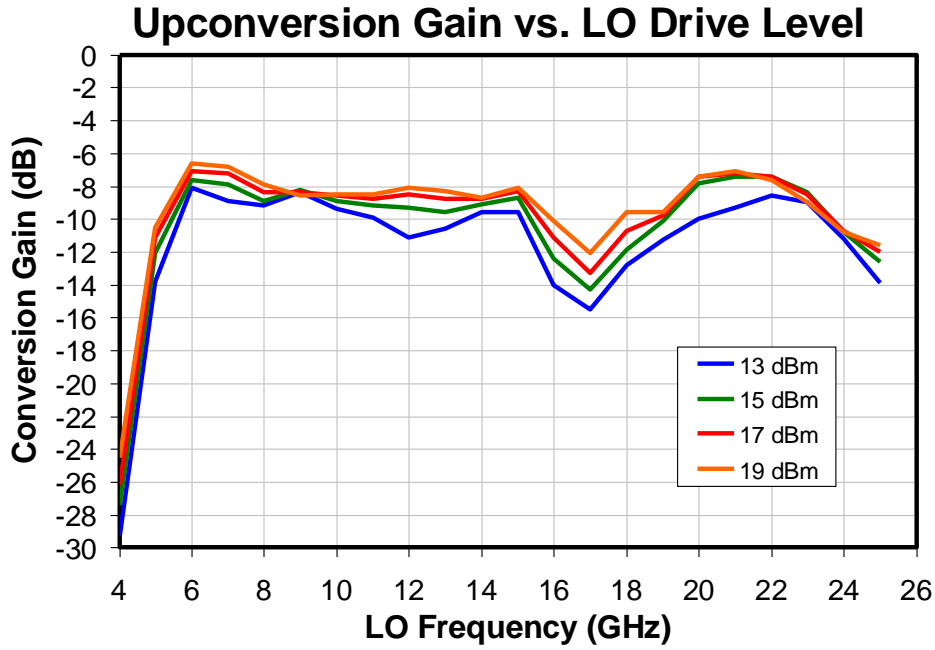

Typical Performance

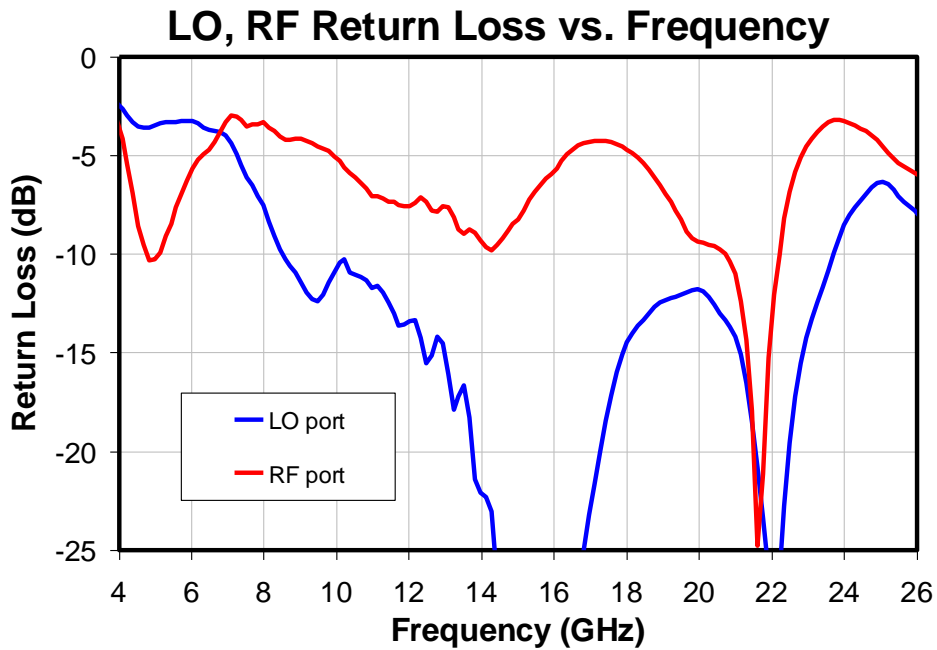
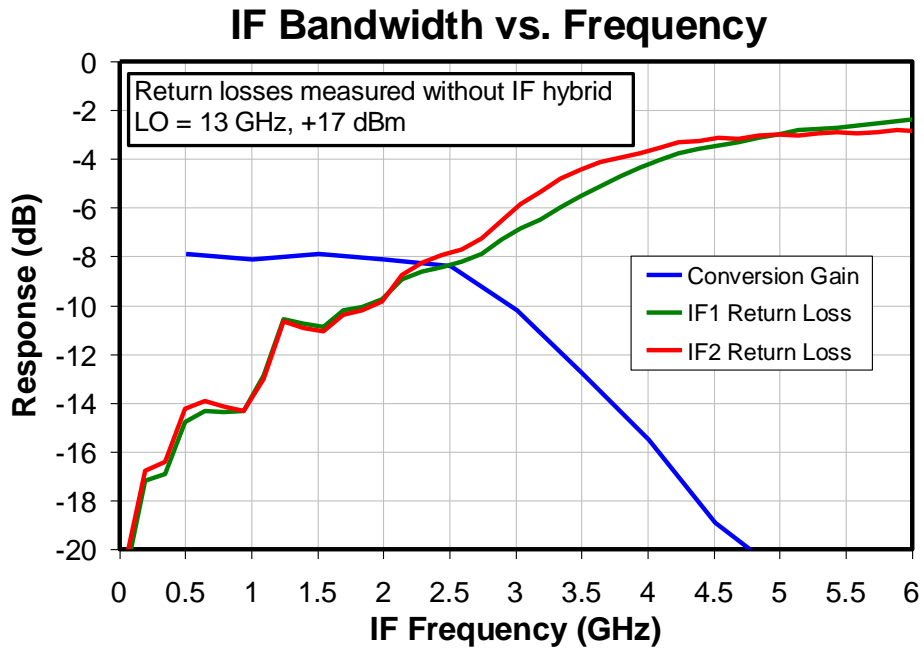

Typical Performance

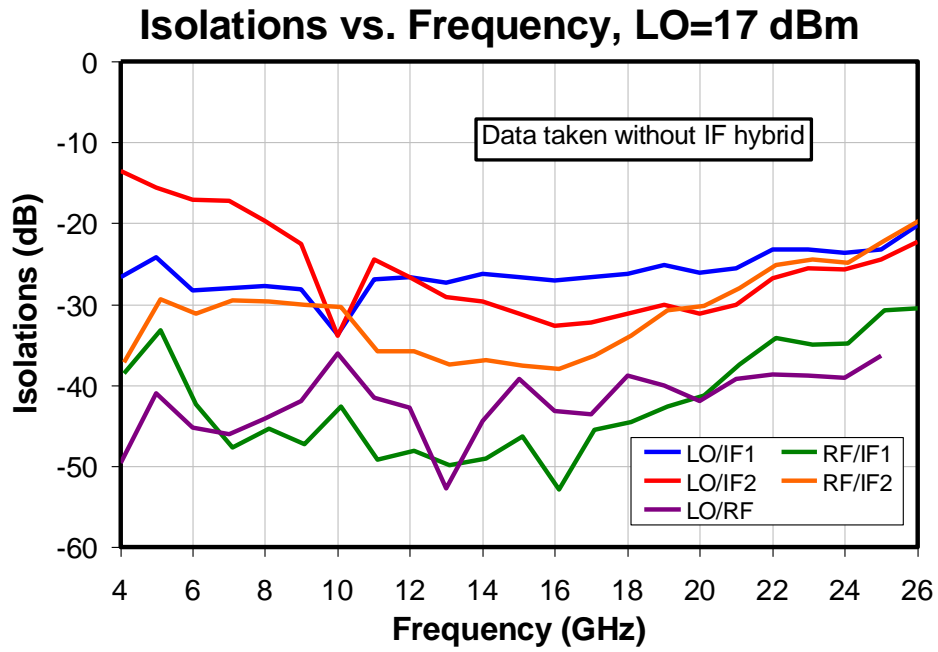



## Thermal and Reliability Information

Parameter	Test Conditions	Value	Units
Thermal Resistance ( $\theta_{JC}$ ) <sup>(1)</sup>	T <sub>BASE</sub> = 85 °C, CW, LO P <sub>IN</sub> = 17 dBm (0.05 W), P <sub>DISS</sub> = 0.05 W	400	°C/W
Channel Temperature (T <sub>CH</sub> ) <sup>(1)</sup>		105	°C
Median Lifetime (T <sub>M</sub> )		4.0E6	Hrs

Notes:

1. Measured to the back of the package.

## Spur Performance

mRF	nLO				
	0	1	2	3	4
0	x	-11	26		
1	46	0	54	44	
2			53	64	
3				66	
4					

mRF	nLO				
	0	1	2	3	4
0	x	-8	11		
1	27	0	41	36	
2	61	67	48	66	65
3		68		62	
4					

RF = 14.1 GHz, -10 dBm

LO = 14 GHz, +17 dBm

All values in dBc below IF output power level (1RF – 1LO)

Data taken as downconverter with no IF hybrid

IF1 response in top table, IF2 response in bottom table.

**Evaluation Board (EVB) Assembly Layout**

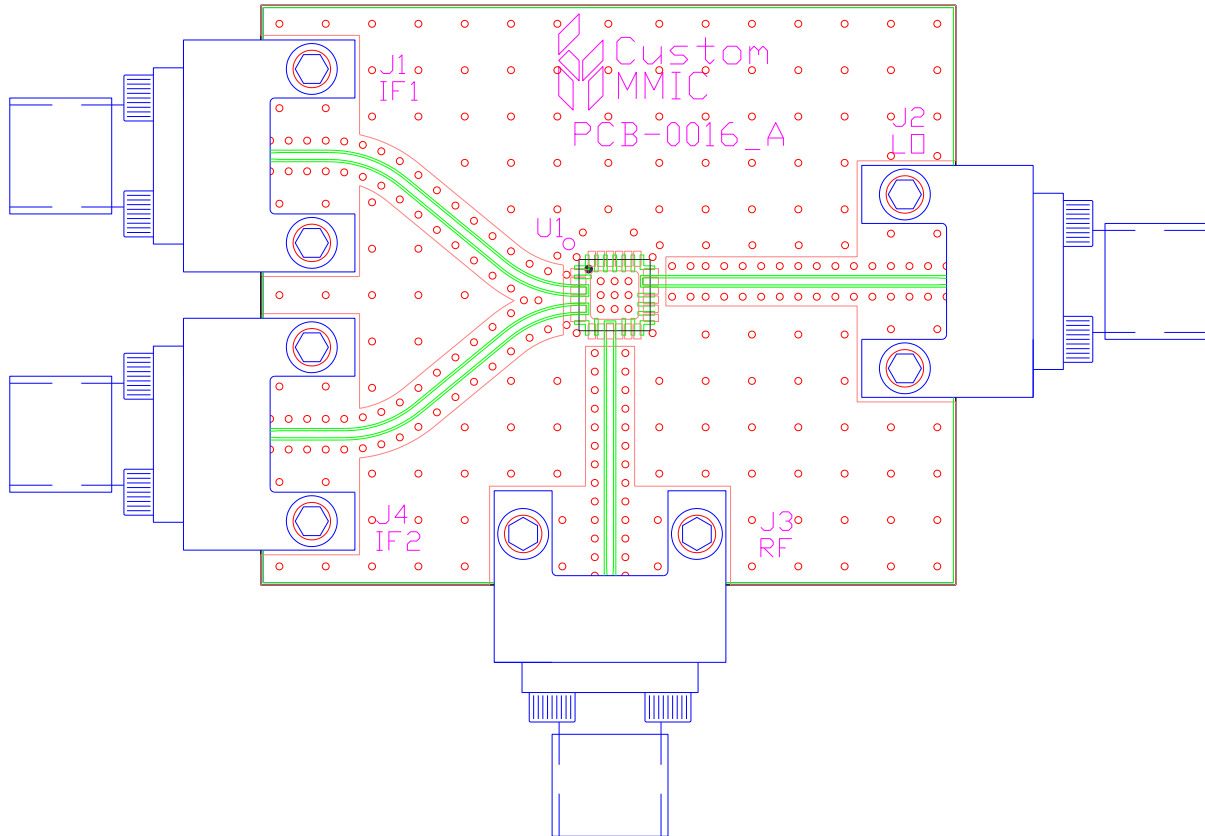

**Bill of Materials for QPX0001EVB1**

Reference Des.	Value	Description	Manuf.	Part Number
J1, J2, J3, J4		End Launch Connector		
U1		QPX0001 I/Q Mixer	Qorvo	
PCB		PCB-0016 Evaluation PCB		

**Mechanical Information**

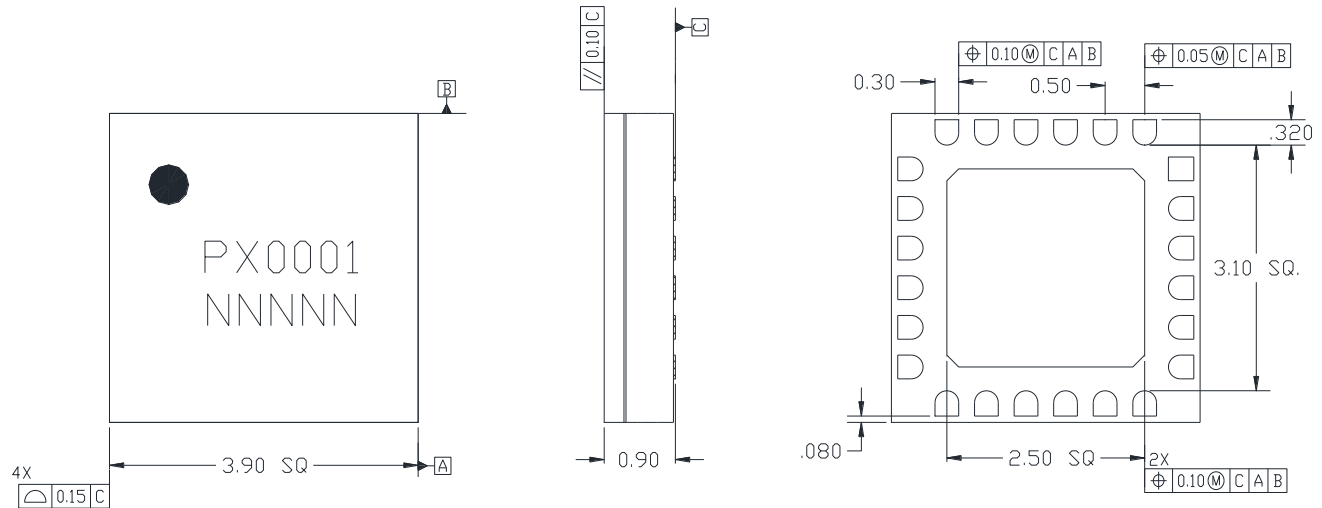

**NOTES:**

1. ALL DIMENSIONS AND TOLERANCES ARE WITHIN THOSE INDICATED IN JEDEC MO-220 WITH EXCEPTION OF TOTAL THICKNESS. ALL DIMENSION SHOWN AS mm. CONTROLLING DIMENSION ARE IN mm.
2. LEAD FINISH: ELECTROLESS NICKEL ELECTROLESS PALLADIUM IMMERSION GOLD (ENEPIG) PLATING IN ACCORDANCE WITH IPC-4556
3. MARKING: ALL MARKING SHALL BE PERMANENT AND LEGIBLE  
 LINE 1: PART NUMBER AS INDICATED  
 LINE 2: REPRESENTED A 5 DIGITS NNNNN UNIQUE ALPHANUMERIC LOT NUMBER OR LAST 4 DIGITS OF THE CUSTOM MMIC PD NUMBER
4. INDICATED DIMENSION/TOLERANCE APPLIES TO LEADS AND EXPOSED PAD.
5. REFERENCE ASSEMBLY DRAWING DRAW-AD-0046 FOR ASSEMBLY INFORMATION.
6. ALTERNATE PIN #1 IDENTIFIER WITH CORNER CHAMFER ON GROUND PADDLE IS ACCEPTABLE.

**Recommended PCB Land Pattern**

Qorvo recommends that the user develop the land pattern that will provide the best design for proper solder reflow and device attach for their specific application. Please review Qorvo Application Note AN 105 for a recommended land pattern approach.

**Recommended Solder Reflow Profile**

Qorvo recommends screen printing with belt furnace reflow to ensure proper solder reflow and device attach. Please review Qorvo Application Note AN 102 for a recommended solder reflow profile.

Pin Diagram

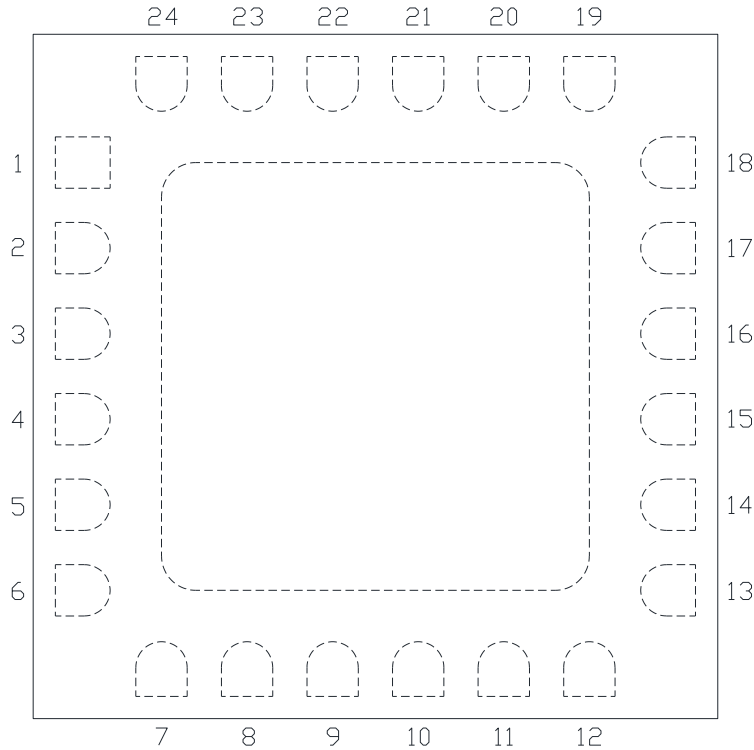

Pin Description

Pad No.	Symbol	Description
1, 4, 6, 7, 11-15, 18-24	N/C	No connection required. These pins may be connected to RF/DC ground.
3, 5	IF1, IF2	These pins are DC coupled. For applications not requiring operation to DC, these ports should be DC blocked externally using a series capacitor whose value has been chosen to pass the necessary IF frequency range. For operation to DC, these pins must not source or sink more than 16 mA of current or part non-function or part failure may result.
9	RF	This pin is AC coupled and matched to 50 Ohms.
17	LO	This pin is AC coupled and matched to 50 Ohms.
2, 8, 10, 16, and die paddle	Ground	Connect to RF / DC ground

## Assembly Notes

1. Compatible with lead-free soldering processes with 260°C peak reflow temperature.
2. Contact plating: ENEPIG
3. Solder rework not recommended.
4. See Application Note AN102 for further information regarding soldering.

## Recommended Soldering Temperature Profile

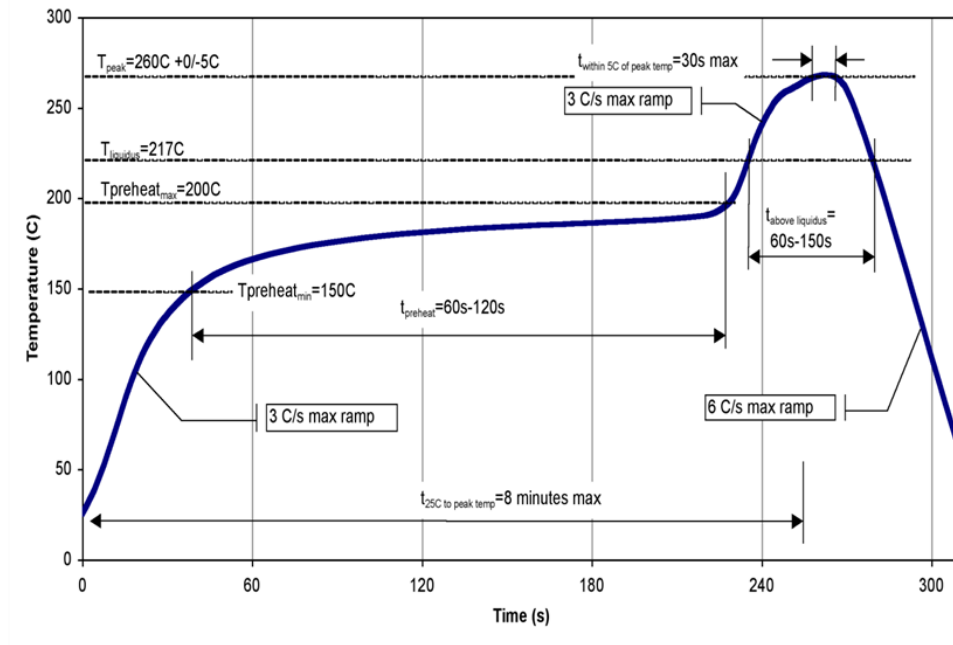

## Handling Precautions

Parameter	Rating	Standard
ESD – Human Body Model (HBM)	Class 1A	ESDA / JEDEC JS-001-2012
MSL – Moisture Sensitivity Level	Level 1	JEDEC standard IPC/JEDEC J-STD-020



Caution!  
ESD-Sensitive Device

## RoHS Compliance

This part is compliant with 2011/65/EU RoHS directive (Restrictions on the Use of Certain Hazardous Substances in Electrical and Electronic Equipment) as amended by Directive 2015/863/EU.

This product also has the following attributes:

- Lead Free
- Halogen Free (Chlorine, Bromine)
- Antimony Free
- TBBP-A (C<sub>15</sub>H<sub>12</sub>Br<sub>4</sub>O<sub>2</sub>) Free
- PFOS Free
- SVHC Free

## Contact Information

For the latest specifications, additional product information, worldwide sales and distribution locations:

Web: [www.qorvo.com](http://www.qorvo.com)

Tel: 1-844-890-8163

Email: [customer.support@qorvo.com](mailto:customer.support@qorvo.com)

## Important Notice

The information contained herein is believed to be reliable; however, Qorvo makes no warranties regarding the information contained herein and assumes no responsibility or liability whatsoever for the use of the information contained herein. All information contained herein is subject to change without notice. Customers should obtain and verify the latest relevant information before placing orders for Qorvo products. The information contained herein or any use of such information does not grant, explicitly or implicitly, to any party any patent rights, licenses, or any other intellectual property rights, whether with regard to such information itself or anything described by such information. **THIS INFORMATION DOES NOT CONSTITUTE A WARRANTY WITH RESPECT TO THE PRODUCTS DESCRIBED HEREIN, AND QORVO HEREBY DISCLAIMS ANY AND ALL WARRANTIES WITH RESPECT TO SUCH PRODUCTS WHETHER EXPRESS OR IMPLIED BY LAW, COURSE OF DEALING, COURSE OF PERFORMANCE, USAGE OF TRADE OR OTHERWISE, INCLUDING THE IMPLIED WARRANTIES OF MERCHANTABILITY AND FITNESS FOR A PARTICULAR PURPOSE.**

Without limiting the generality of the foregoing, Qorvo products are not warranted or authorized for use as critical components in medical, life-saving, or life-sustaining applications, or other applications where a failure would reasonably be expected to cause severe personal injury or death.

Copyright 2020 © Qorvo, Inc. | Qorvo is a registered trademark of Qorvo, Inc.

# Mouser Electronics

Authorized Distributor

Click to View Pricing, Inventory, Delivery & Lifecycle Information:

[Qorvo:](#)

[QPX0001SR](#)