

Product Overview

The CMD310C3 is a sub-harmonically pumped mixer die with an integrated LO amplifier housed in a leadless 3x3 mm surface mount QFN package. The CMD310C3 can be used as an upconverter or downconverter. The device has low conversion loss and excellent 2LO to RF isolation eliminating the need for additional filtering. The CMD310C3 requires only -2 dBm LO drive and operates on a single positive supply voltage. The sub-harmonic design and low LO drive level allows for less stringent oscillator requirements.

Functional Block Diagram

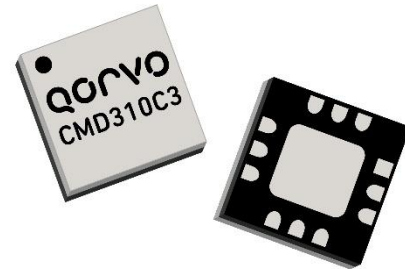
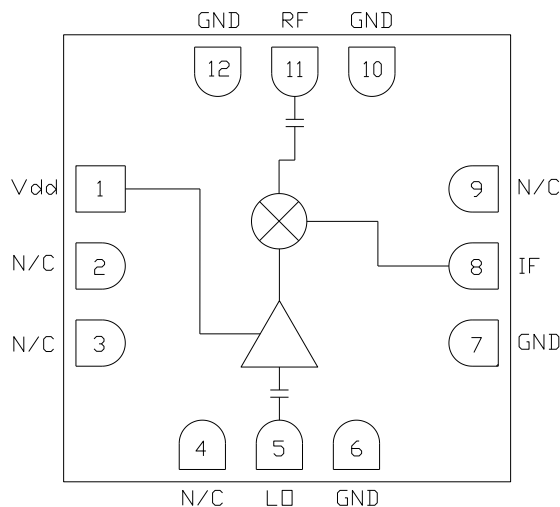

Key Features

- Integrated LO Amplifier
- High Isolations
- Sub-Harmonic x2 LO
- Single Positive Supply Voltage
- HMC264LC3B Replacement

Ordering Information

Part No.	Description
CMD310C3	20-32 GHz Sub-harmonic x2 Mixer, 100 Piece 7" Reel
CMD310C3-EVB	Evaluation Board

Electrical Performance ($V_{dd} = 4\text{ V}$, $IF = 100\text{ MHz}$, $LO = -2\text{ dBm}$, $RF = 26\text{ GHz}$, $T_A = 25\text{ }^\circ\text{C}$)

Parameter	Min	Typ	Max	Units
Frequency Range, RF		20 - 32		GHz
Frequency Range, LO		10 - 16		GHz
Frequency Range, IF	DC		6	GHz
Conversion Loss		8.5		dB
Noise Figure (SSB)		8.5		dB
2LO to RF Isolation		33		dB
2LO to IF Isolation		60		dB
Input IP3		11		dBm
Input P1dB		3		dBm
Supply Current	19	27	35	mA

Unless otherwise noted, all measurements performed as a downconverter, IF = 100 MHz USB

Absolute Maximum Ratings

Parameter	Rating
RF / IF Input Power	+13 dBm
LO Drive	+13 dBm
Drain Voltage, V_{dd}	5.5 V
Channel Temperature, T_{ch}	150 °C
Power Dissipation, P_{diss}	0.33 W
Thermal Resistance, θ_{JC}	199.4 °C/W
Operating Temperature	-40 to 85 °C
Storage Temperature	-55 to 150 °C

Exceeding any one or combination of the maximum ratings may cause permanent damage to the device.

Recommended Operating Conditions

Parameter	Min	Typ	Max	Units
V_{dd}	2	4	5	V
I_{dd}		27		mA

Electrical performance is measured at specific test conditions. Electrical specifications are not guaranteed over all recommended operating conditions.

Electrical Specifications ($V_{dd} = 4$ V, $I_F = 100$ MHz, $LO = -2$ dBm, $T_A = 25$ °C)

Parameter	Min	Typ	Max	Min	Typ	Max	Units
Frequency Range, RF	20 - 26			26 - 32			GHz
Frequency Range, LO	10 - 13			13 - 16			GHz
Frequency Range, IF	DC - 6			DC - 6			GHz
Conversion Loss		9	12		11	14	dB
Noise Figure (SSB)		9	12		11	14	dB
2LO to RF Isolation	23	32		28	37		dB
2LO to IF Isolation	44	55		55	65		dB
Input IP3		12			12		dBm
Input P1dB		2			4		dBm
Supply Current	19	27	35	19	27	35	mA

Unless otherwise noted, all measurements performed as a downconverter, $I_F = 100$ MHz USB

Typical Performance

Conversion Gain vs. Temperature, LO = -2 dBm, IF = 100 MHz USB

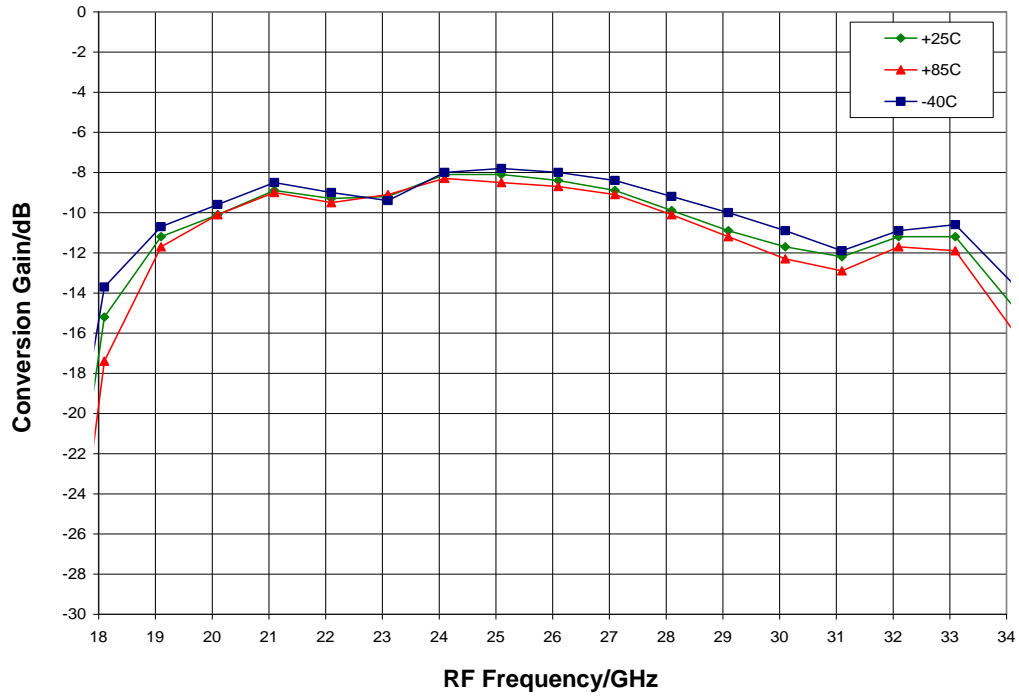

Conversion Gain vs. LO Drive, IF = 100 MHz USB, T_A = 25 °C

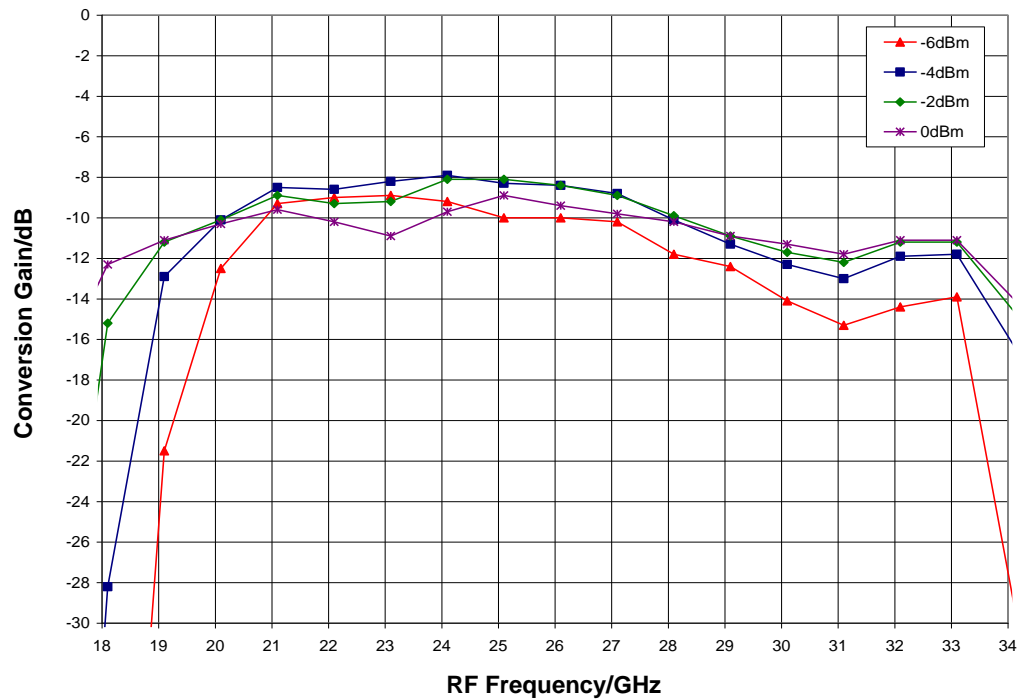

Typical Performance

Isolations, LO = -2 dBm, T_A = 25 °C

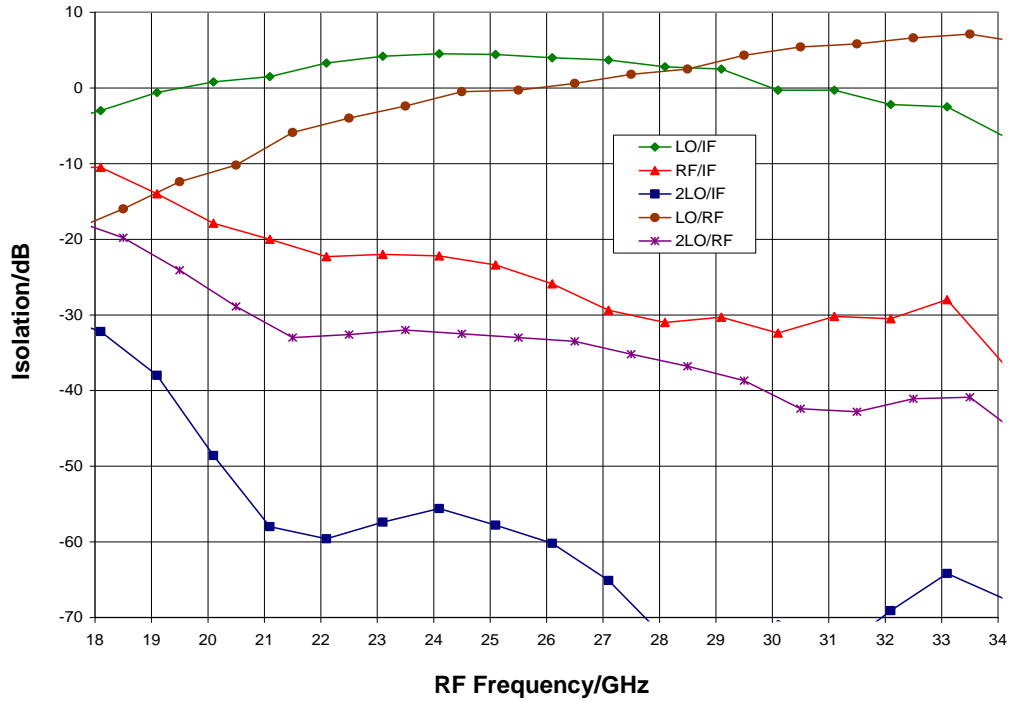

Return Loss, LO = -2 dBm, T_A = 25 °C

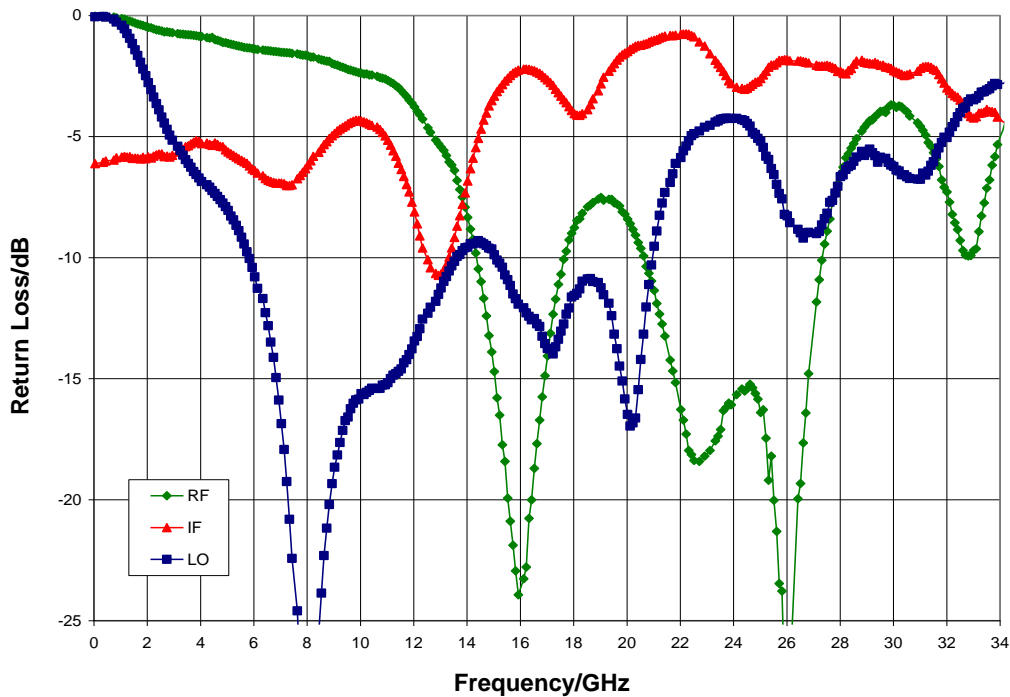

Typical Performance

IF Bandwidth vs. LO Drive, $T_A = 25\text{ }^\circ\text{C}$

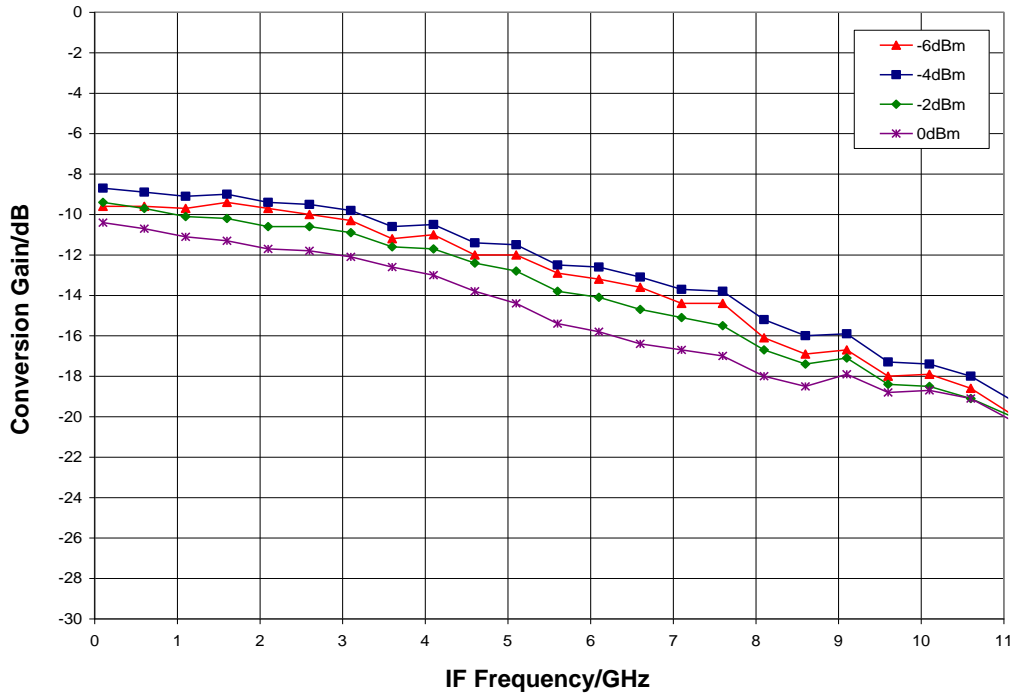

Upconverter Performance, Conversion Gain vs. LO Drive, $T_A = 25\text{ }^\circ\text{C}$

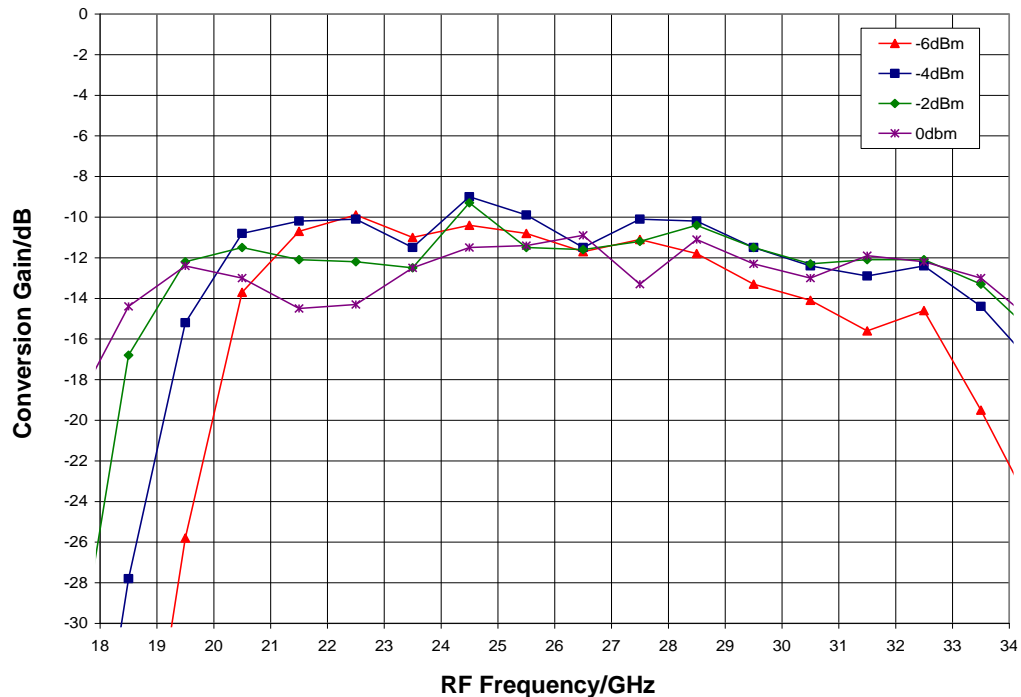

Typical Performance

Input IP3 vs. Temperature, LO = -2 dBm

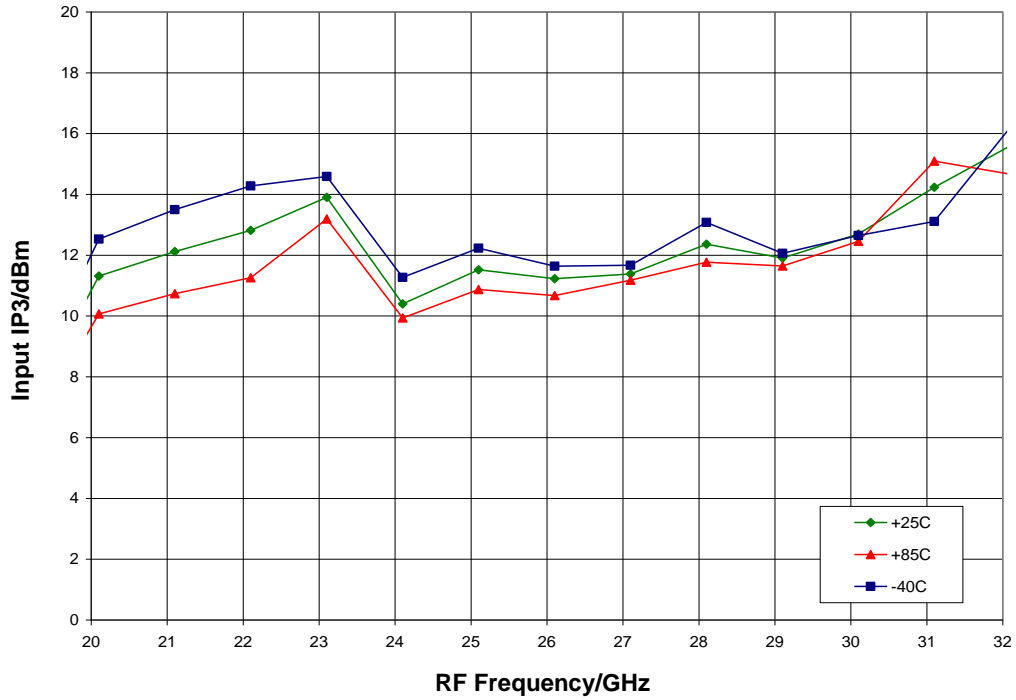

Input IP3 vs. LO Drive, T_A = 25 °C

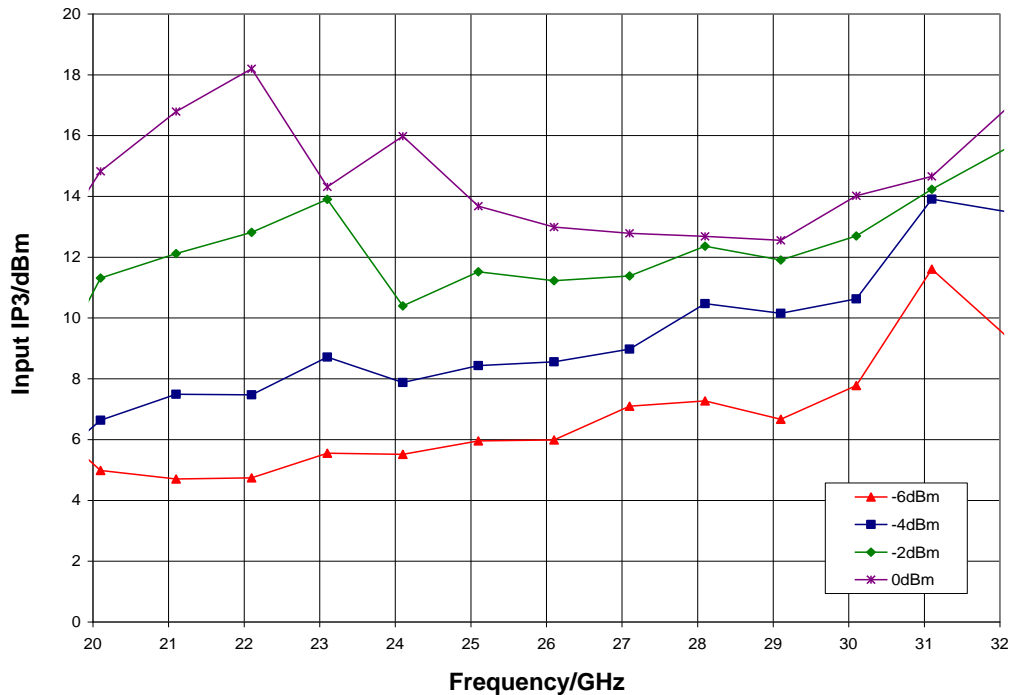

Typical Performance

Input P1dB vs. Temperature, LO = -2 dBm, T_A = 25 °C

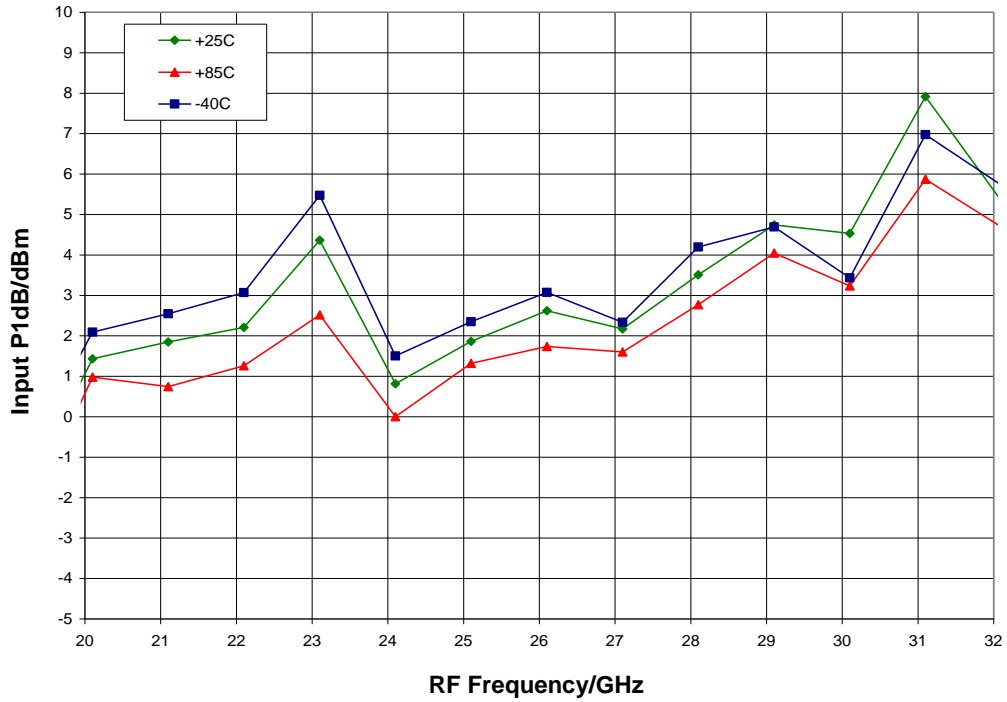

M x N Spur Table

mRF	nLO				
	0	1	2	3	4
0	X	-16	43	29	55
1	21	53	0	55	50
2	71	63	71	44	58
3			71	71	71
4					71

RF = 30 GHz @ -10 dBm
 LO = 13.6 GHz @ -4 dBm
 All values in dBc below the IF output power level (1RF - 2LO)

Mechanical Information

Package Information and Dimensions

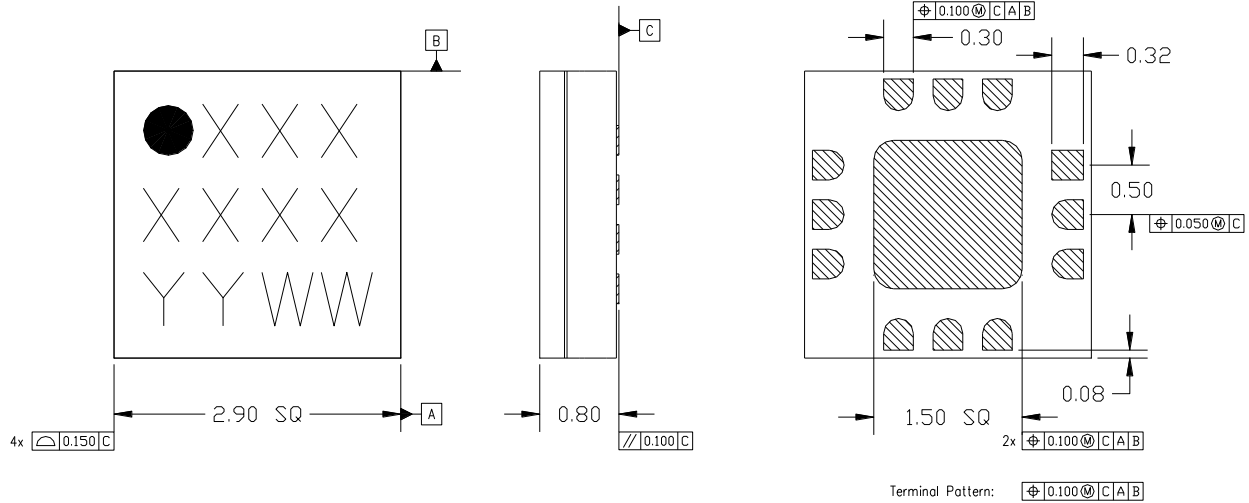

Notes:

- All dimensions shown in mm.
- Material: Black alumina
- Lead finish
 - Ni: 8.89um max, 1.27um min
 - Pd: 0.17um max, 0.07um min
 - Au: 0.254um max, 0.03um min
- Marking
 - Line 1: Part number
 - Example: CMD310C3 shall be marked as 310
 - Line 2: Lot number
 - Line 3: Date code - Last 2 digits of the year of manufacture followed by a 2 digit week code
- Alternate pin #1 identifier is a single square pad
- Alternate die paddle may have chamfered corners

Recommended PCB Land Pattern

Qorvo recommends that the user develop the land pattern that will provide the best design for proper solder reflow and device attach for their specific application. Please review Qorvo Application Note AN 105 for a recommended land pattern approach.

Recommended Solder Reflow Profile

Qorvo recommends screen printing with belt furnace reflow to ensure proper solder reflow and device attach. Please review Qorvo Application Note AN 102 for a recommended solder reflow profile.

Pin Description

Pin Diagram

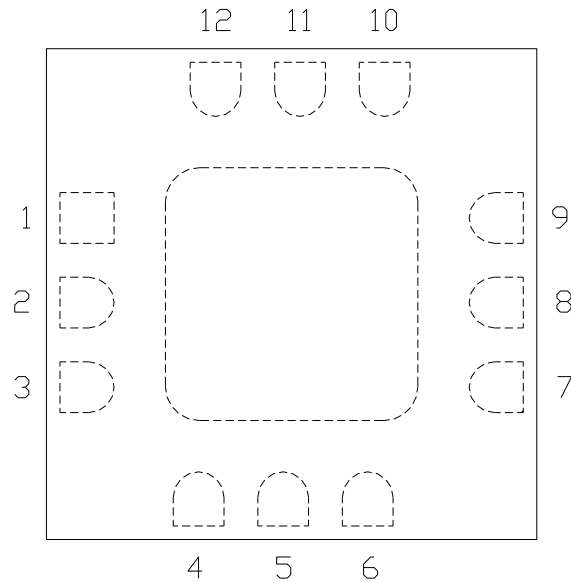

Functional Description

Pin	Function	Description	Schematic
1	V _{dd}	Power supply voltage Decoupling and bypass caps required	
2 - 4, 9	N/C	No connection required These pins may be connected to RF / DC ground	
5	LO	DC blocked and 50 ohm matched	
8	IF	This pin is DC coupled and should be DC blocked externally using a series capacitor whose value has been chosen to pass the necessary IF frequency. Any applied DC voltage to this pin will result in die non-function and possible die failure	
11	RF	DC blocked and 50 ohm matched	
6, 7, 10, 12 and die paddle	Ground	Connect to RF / DC ground	

Applications Information

Evaluation Board

The circuit board shown has been developed for optimized assembly at Qorvo. A sufficient number of via holes should be used to connect the top and bottom ground planes. As surface mount processes vary, careful process development is recommended.

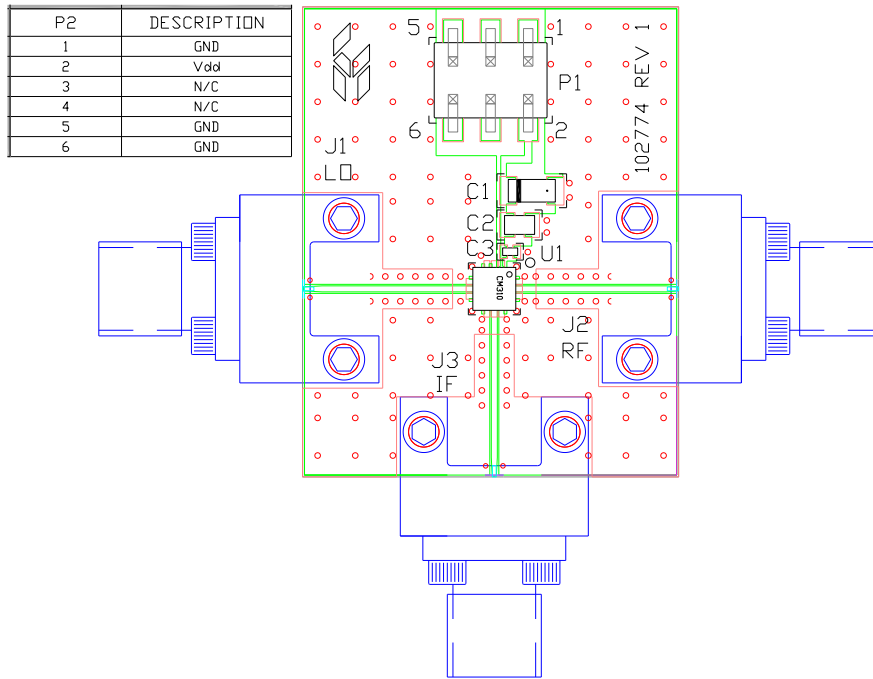

Designator	Value	Description
J1 - J3		2.92 mm End Launch Connector
P1		6 Pin Header
C1	0.33 μ F	Capacitor, Tantalum
C2	1000 pF	Capacitor, 0603
C3	100 pF	Capacitor, 0402
U1		CMD310C3 Sub-harmonic x2 Mixer
PCB		102774 Evaluation PCB

GaAs MMIC devices are susceptible to damage from Electrostatic Discharge. Proper precautions should be observed during handling, assembly and test.

Handling Precautions

Parameter	Rating	Standard
ESD – Human Body Model (HBM)	Class 1A	ESDA / JEDEC JS-001-2012
MSL – Moisture Sensitivity Level	Level 1	JEDEC standard IPC/JEDEC J-STD-020



Caution!
 ESD-Sensitive Device

RoHS Compliance

This part is compliant with 2011/65/EU RoHS directive (Restrictions on the Use of Certain Hazardous Substances in Electrical and Electronic Equipment) as amended by Directive 2015/863/EU.

This product also has the following attributes:

- Lead Free
- Antimony Free
- TBBP-A (C₁₅H₁₂Br₄O₂) Free
- SVHC Free
- Halogen Free
- PFOS Free

Contact Information

For the latest specifications, additional product information, worldwide sales and distribution locations:

Web: www.qorvo.com

Tel: 1-844-890-8163

Email: customer.support@qorvo.com

Important Notice

The information contained in this Data Sheet and any associated documents (“Data Sheet Information”) is believed to be reliable; however, Qorvo makes no warranties regarding the Data Sheet Information and assumes no responsibility or liability whatsoever for the use of said information. All Data Sheet Information is subject to change without notice. Customers should obtain and verify the latest relevant Data Sheet Information before placing orders for Qorvo® products. Data Sheet Information or the use thereof does not grant, explicitly, implicitly or otherwise any rights or licenses to any third party with respect to patents or any other intellectual property whether with regard to such Data Sheet Information itself or anything described by such information.

DATA SHEET INFORMATION DOES NOT CONSTITUTE A WARRANTY WITH RESPECT TO THE PRODUCTS DESCRIBED HEREIN, AND QORVO HEREBY DISCLAIMS ANY AND ALL WARRANTIES WITH RESPECT TO SUCH PRODUCTS WHETHER EXPRESS OR IMPLIED BY LAW, COURSE OF DEALING, COURSE OF PERFORMANCE, USAGE OF TRADE OR OTHERWISE, INCLUDING THE IMPLIED WARRANTIES OF MERCHANTABILITY AND FITNESS FOR A PARTICULAR PURPOSE. Without limiting the generality of the foregoing, Qorvo® products are not warranted or authorized for use as critical components in medical, life-saving, or life-sustaining applications, or other applications where a failure would reasonably be expected to cause severe personal injury or death. Applications described in the Data Sheet Information are for illustrative purposes only. Customers are responsible for validating that a particular product described in the Data Sheet Information is suitable for use in a particular application.

© 2022 Qorvo US, Inc. All rights reserved. This document is subject to copyright laws in various jurisdictions worldwide and may not be reproduced or distributed, in whole or in part, without the express written consent of Qorvo US, Inc. | QORVO® is a registered trademark of Qorvo US, Inc.