

Product Overview

The CMD175P4 is a GaAs MMIC 5-bit phase shifter housed in a leadless 4x4 mm plastic surface mount package. The CMD175P4 operates from 2 to 4 GHz and provides 0 to 360 degrees of monotonic phase coverage, with a LSB of 11.25 degrees. The device is controlled with single bit negative logic of 0 or -3 V and features an insertion loss of 7 dB and a phase error of ± 5 degrees. The CMD175P4 is a 50 ohm matched design which eliminates the need for external DC blocks and RF port matching.

Functional Block Diagram

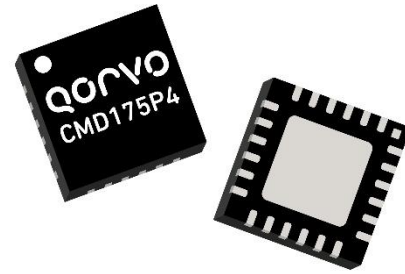
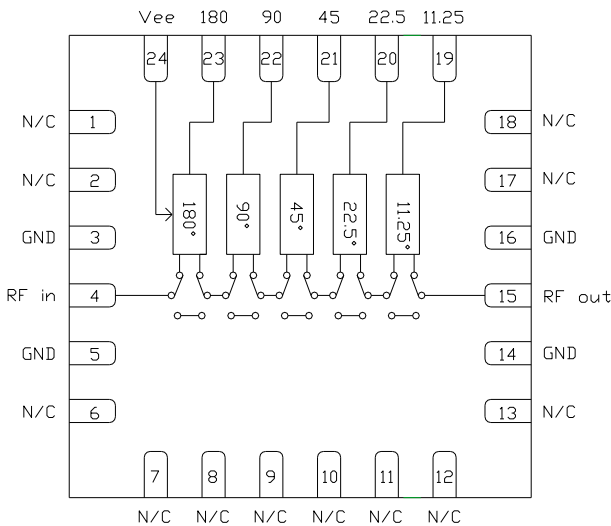

Key Features

- Low Phase Error
- Low Insertion Loss
- 360° Phase Shift, LSB = 11.25°
- Single Bit Negative Logic
- Pb-Free RoHs Compliant 4x4 mm QFN Package

Ordering Information

Part No.	Description
CMD175P4	100 Piece 7" Reel
CMD175P4-EVB	1 Piece Bag

Electrical Performance ($V_{ee} = -3$ V, $V_{ctl} = 0/-3$ V, $T_A = 25^\circ$ C, $F = 3$ GHz)

Parameter	Min	Typ	Max	Units
Frequency Range		2 - 4		GHz
Insertion Loss		7		dB
Input Return Loss		18		dB
Output Return Loss		17		dB
Phase Error		+1 / -8		deg
Input P1dB		24		dBm
Input IP3		37		dBm
Supply Current		4		mA

Absolute Maximum Ratings

Parameter	Rating
Supply Voltage, V_{ee}	-8.0 V
RF Input Power	+30 dBm
Operating Temperature	-40 to 85° C
Storage Temperature	-55 to 150° C

Exceeding any one or combination of the maximum ratings may cause permanent damage to the device.

Recommended Operating Conditions

Parameter	Min	Typ	Max	Units
V_{ee}	-5.0		-3.0	V
I_{ee}		4		mA

Electrical performance is measured at specific test conditions. Electrical specifications are not guaranteed over all recommended operating conditions.

Truth Table

Control Voltage Input					Phase Shift (degrees)
11.25	22.5	45	90	180	
High	High	High	High	High	Reference
Low	High	High	High	High	11.25
High	Low	High	High	High	22.5
High	High	Low	High	High	45
High	High	High	Low	High	90
High	High	High	High	Low	180
Low	Low	Low	Low	Low	348.75

Control Voltage

State	Bias Condition
High	$V_{ee} \pm 0.3$ V
Low	0 ± 0.3 V

Electrical Specifications ($V_{ee} = -3.0$ V, $V_{ctl} = 0/-3$ V, $T_A = 25^\circ$ C)

Parameter	Min	Typ	Max	Min	Typ	Max	Units
Frequency Range		2 - 3			3 - 4		GHz
Insertion Loss		7.5	10		7	8.5	dB
Input Return Loss		15			15		dB
Output Return Loss		17			17		dB
Phase Error		± 8	± 12		+4 / -8	+7 / -12	deg
Insertion Loss Variation		± 0.5			± 0.5		dB
Input P1dB		24			25		dBm
Input IP3		36			37		dBm
Supply Current		4			4		mA

Note: Specification applies to major states

Typical Performance

Insertion Loss, Major States, $V_{ee} = -3.0\text{ V}$, $T_A = 25^\circ\text{ C}$

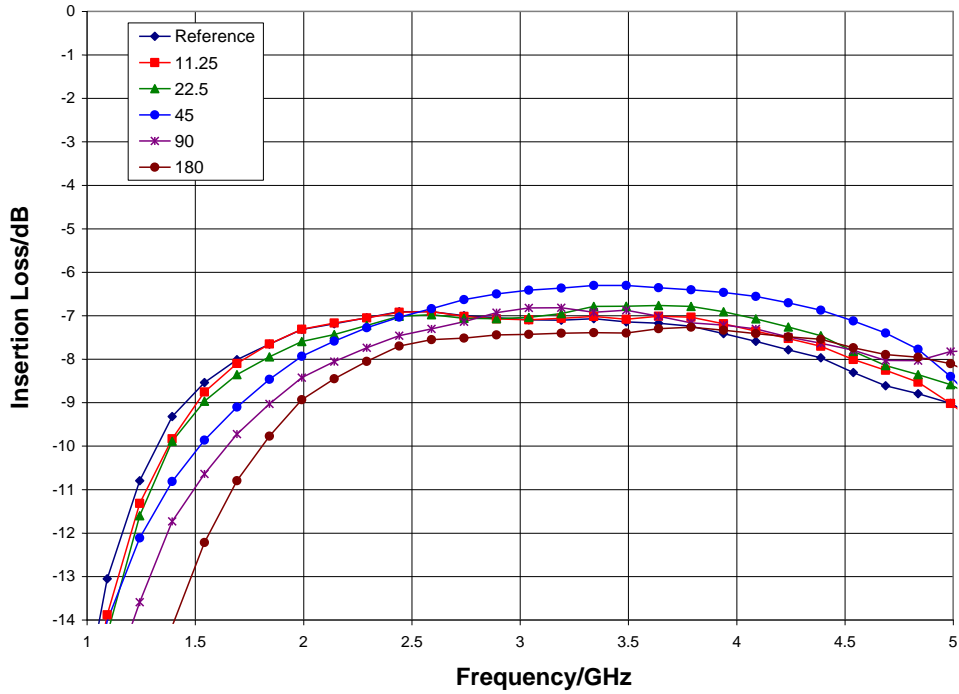

Relative Phase Shift, Major States and All On State, $V_{ee} = -3.0\text{ V}$, $T_A = 25^\circ\text{ C}$

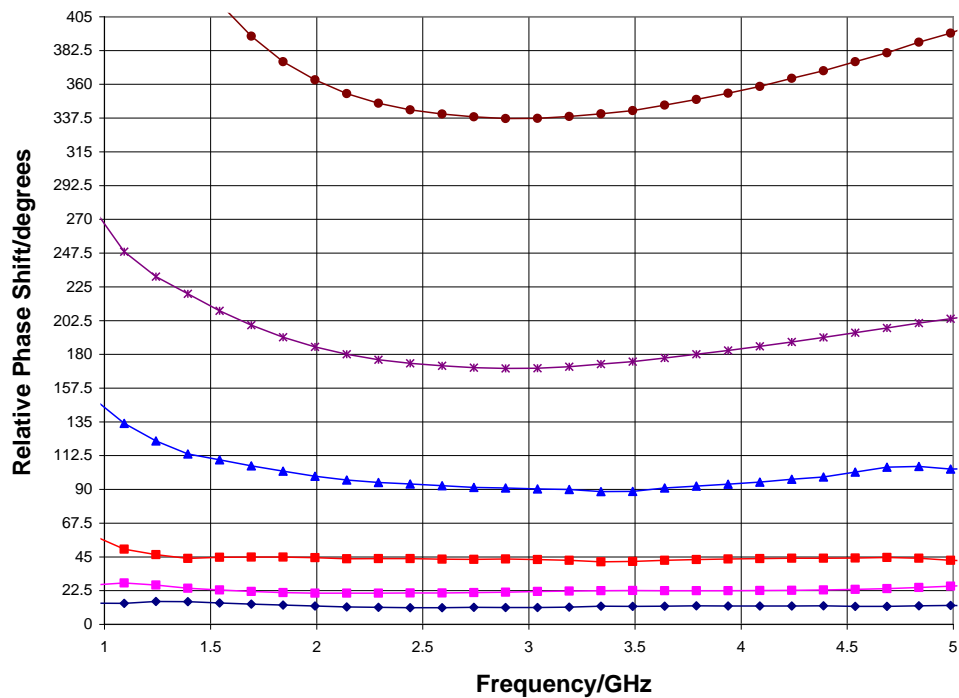

Typical Performance

Input Return Loss, Major States, $V_{ee} = -3.0\text{ V}$, $T_A = 25^\circ\text{ C}$

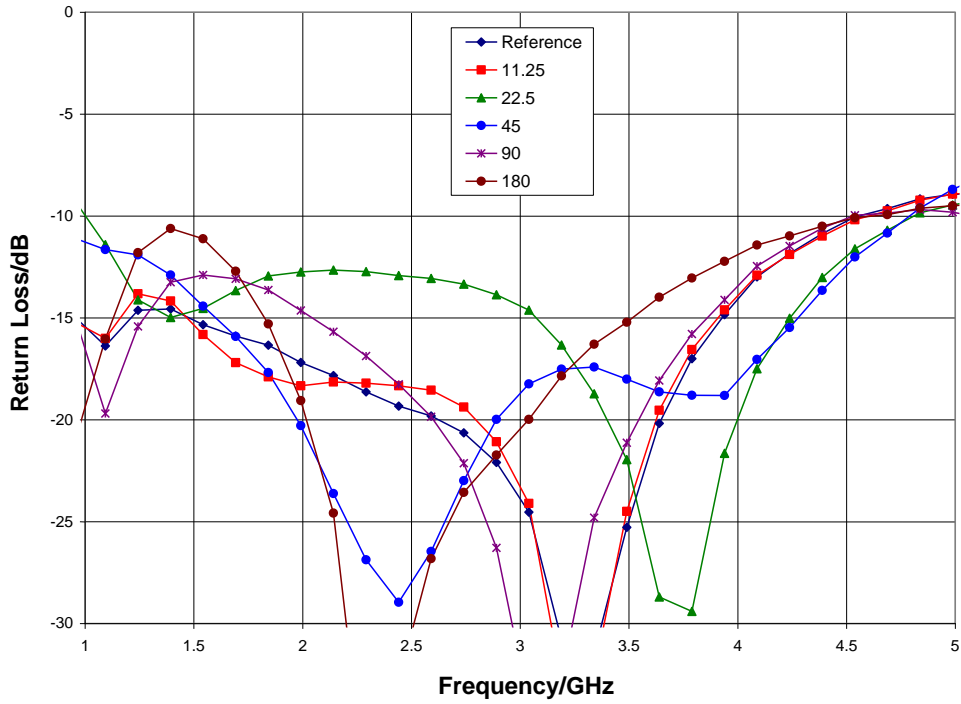

Output Return Loss, Major States, $V_{ee} = -3.0\text{ V}$, $T_A = 25^\circ\text{ C}$

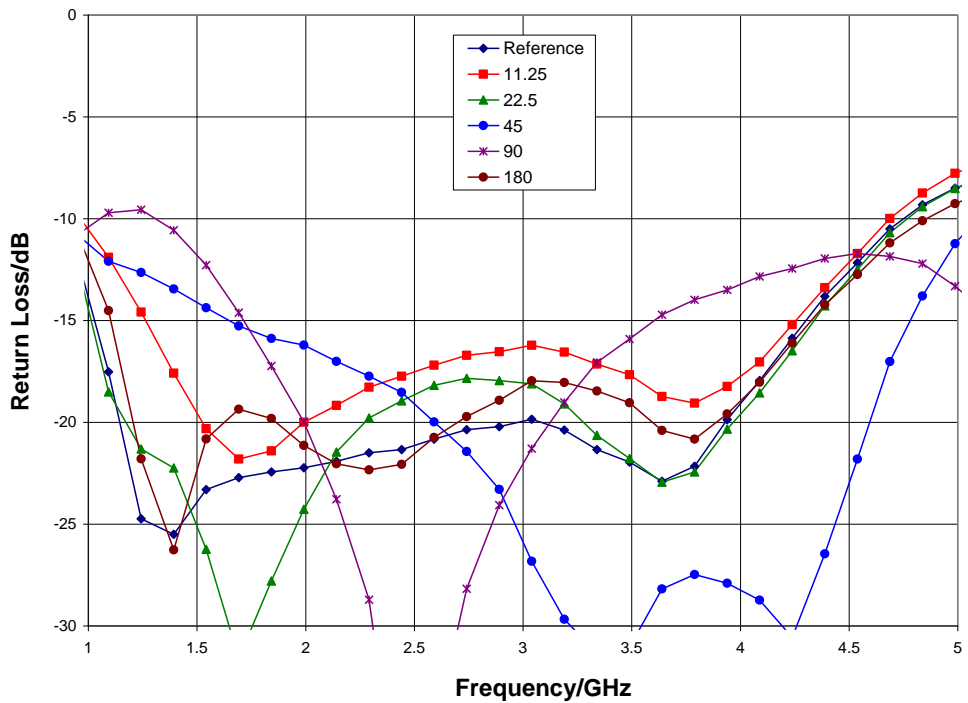

Typical Performance

Normalized Loss, Major States, $V_{ee} = -3.0\text{ V}$

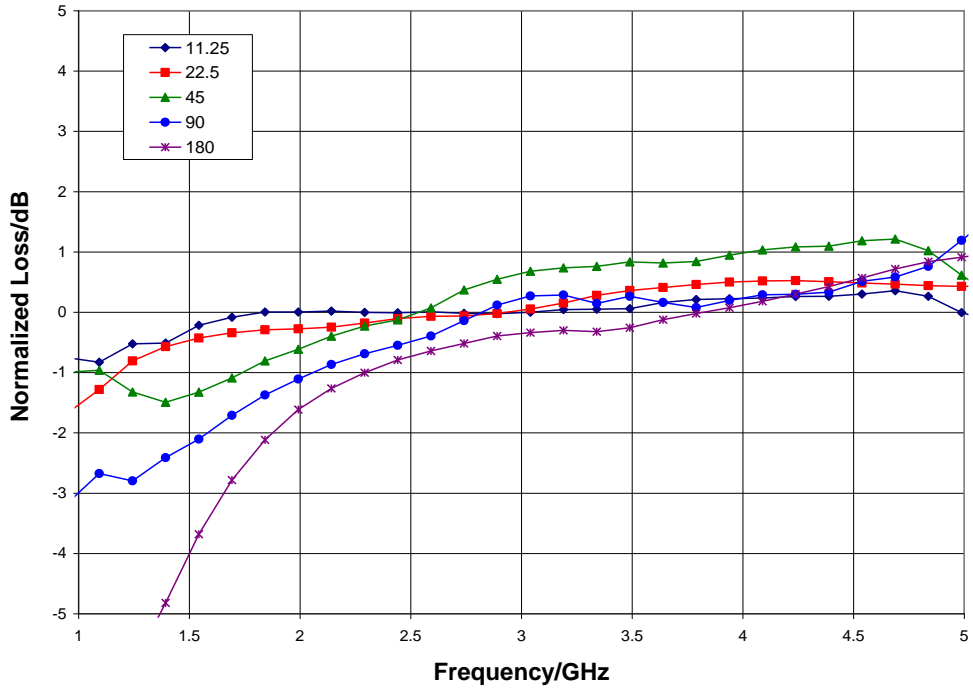

Phase Error, Major States and All On State, $V_{ee} = -3.0\text{ V}$

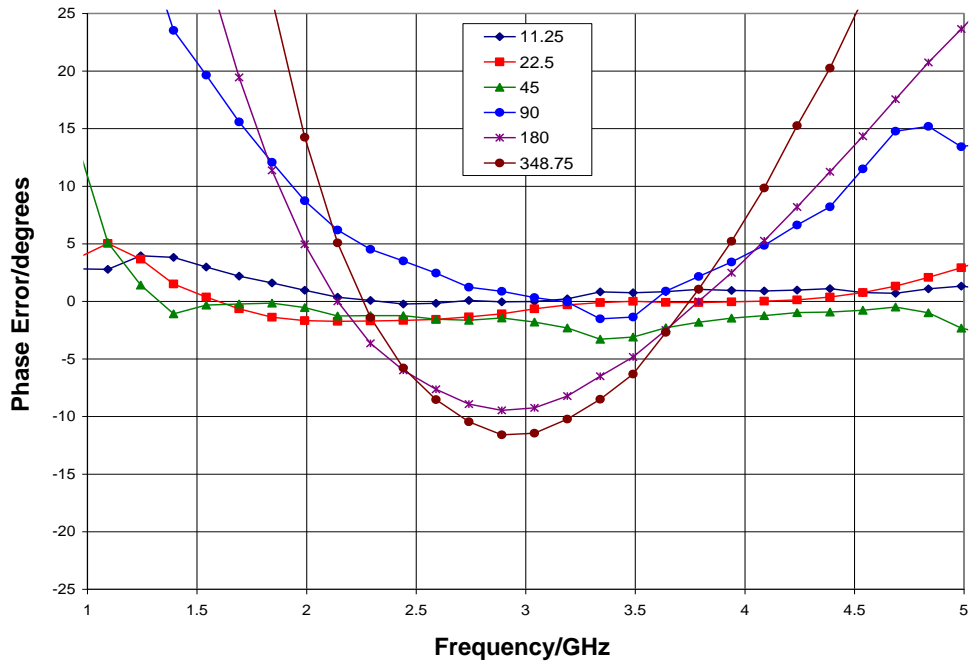

Typical Performance

Insertion Loss vs. Temperature, Reference State, $V_{ee} = -3.0$ V

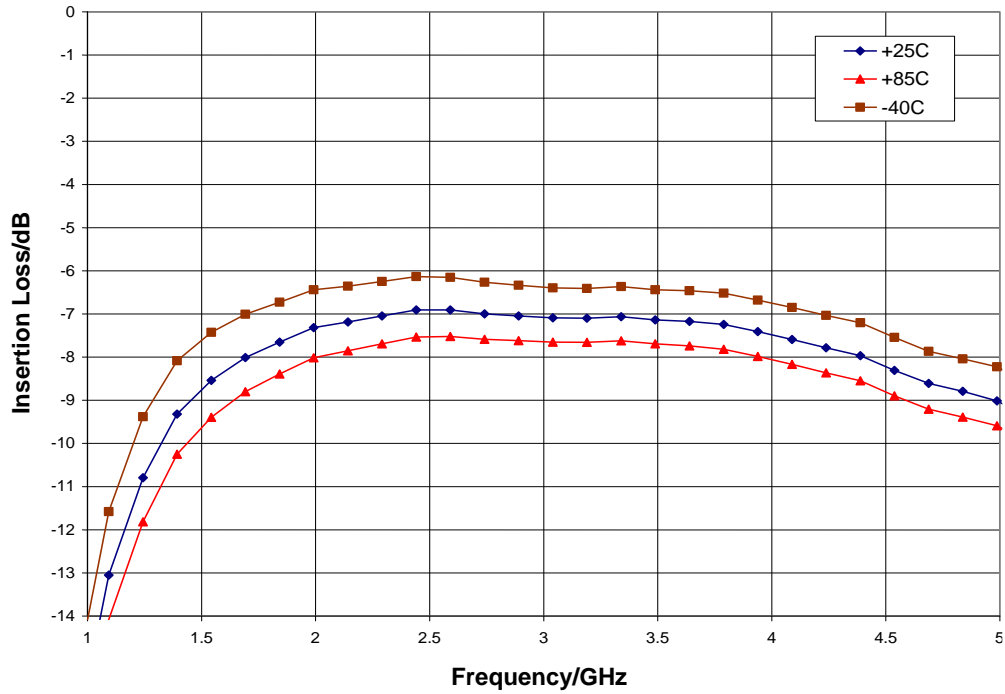

Input P1dB, $V_{ee} = -3.0$ V

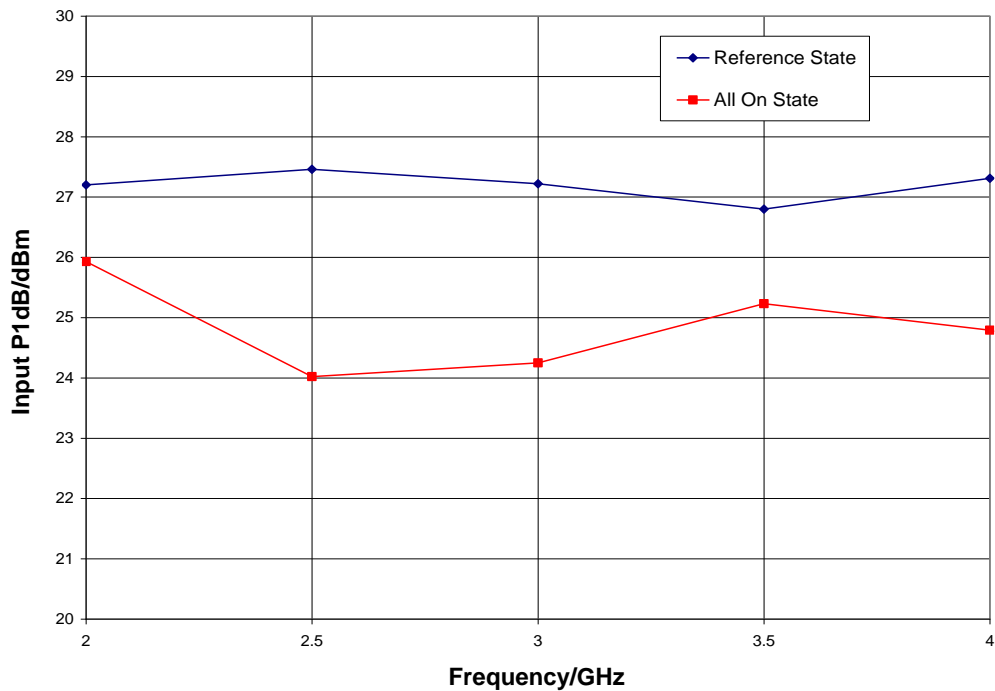

Typical Performance

Input IP3, $V_{ee} = -3.0\text{ V}$

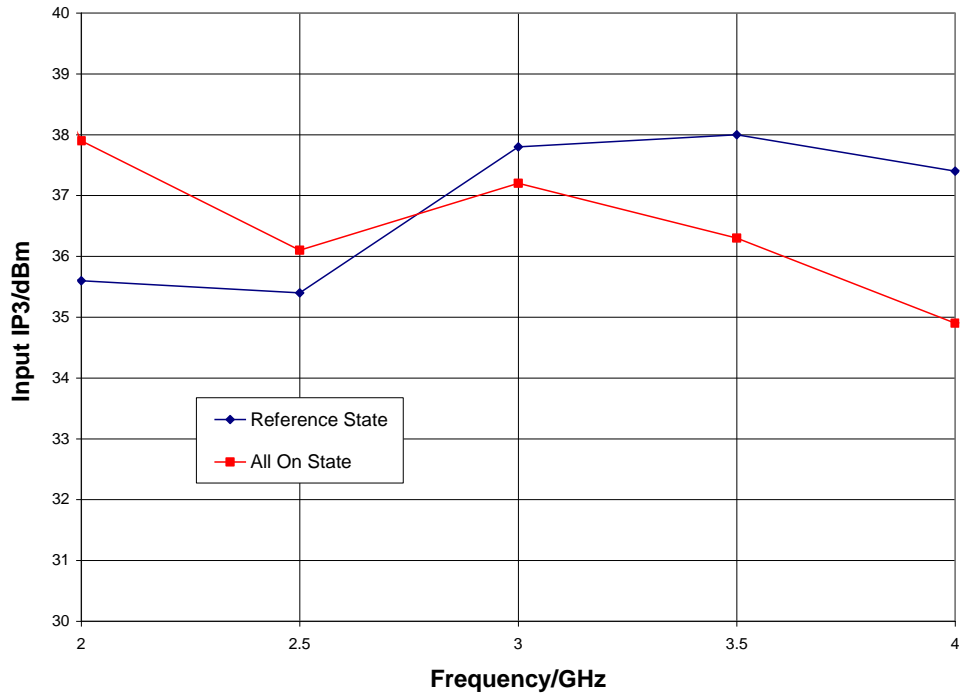

Mechanical Information

Package Information and Dimensions

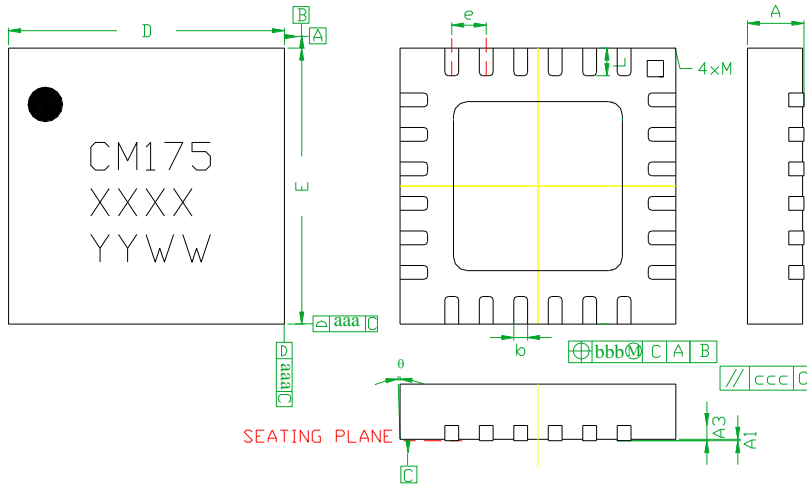

SYMBOLS	DIMENSIONS IN MILLIMETERS		
	MIN	NOM	MAX
A	0.80	0.90	1.00
A1	0	0.02	0.05
A3	---	0.25REF.	---
b	0.18	0.23	0.30
D	3.85	4.00	4.15
D1	---	2.45BSC	---
E	3.85	4.00	4.15
E1	---	2.45BSC	---
e	---	0.50BSC	---
L	0.30	0.40	0.50
theta	0	---	12
aaa	---	0.25	---
bbb	---	0.10	---
ccc	---	0.10	---
M	---	---	0.05

Notes:

1. Dimensions are in millimeters
2. RoHS compliant mold compound
3. Lead frame material: Copper alloy
4. Lead finish: 100% matte Sn
5. Indicated dimension/tolerance applies to leads and exposed pads

Recommended PCB Land Pattern

Qorvo recommends that the user develop the land pattern that will provide the best design for proper solder reflow and device attach for their specific application. Please review Qorvo Application Note AN 105 for a recommended land pattern approach.

Recommended Solder Reflow Profile

Qorvo recommends screen printing with belt furnace reflow to ensure proper solder reflow and device attach. Please review Qorvo Application Note AN 102 for a recommended solder reflow profile.

GaAs MMIC devices are susceptible to damage from Electrostatic Discharge. Proper precautions should be observed during handling, assembly and test.

Pin Description

Pin Diagram

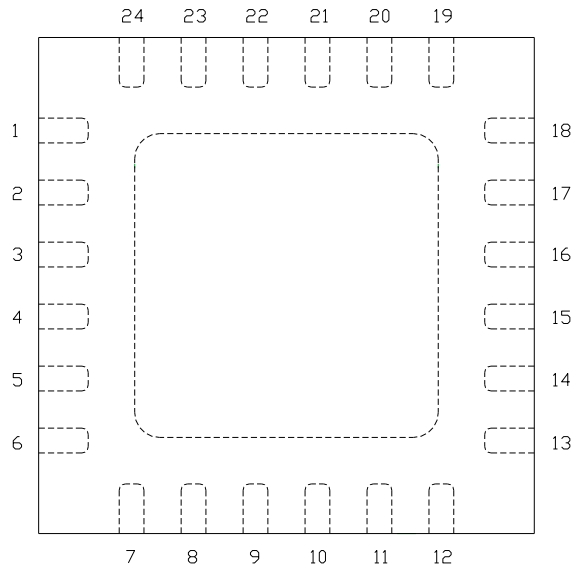

Functional Description

Pad	Function	Description	Schematic
1, 2, 6 - 13, 17, 18	N/C	No connections required These pins may be connected to RF / DC ground.	
4	RF in	DC blocked and 50 ohm matched	
15	RF out	DC blocked and 50 ohm matched	
19	11.25	11.25° control input	
20	22.5	22.5° control input	
21	45	45° control input	
22	90	90° control input	
23	180	180° control input	
24	V _{ee}	Supply voltage	
3, 5, 14, 16 and die paddle	Ground	Connect to RF / DC ground	

Applications Information

Evaluation Board

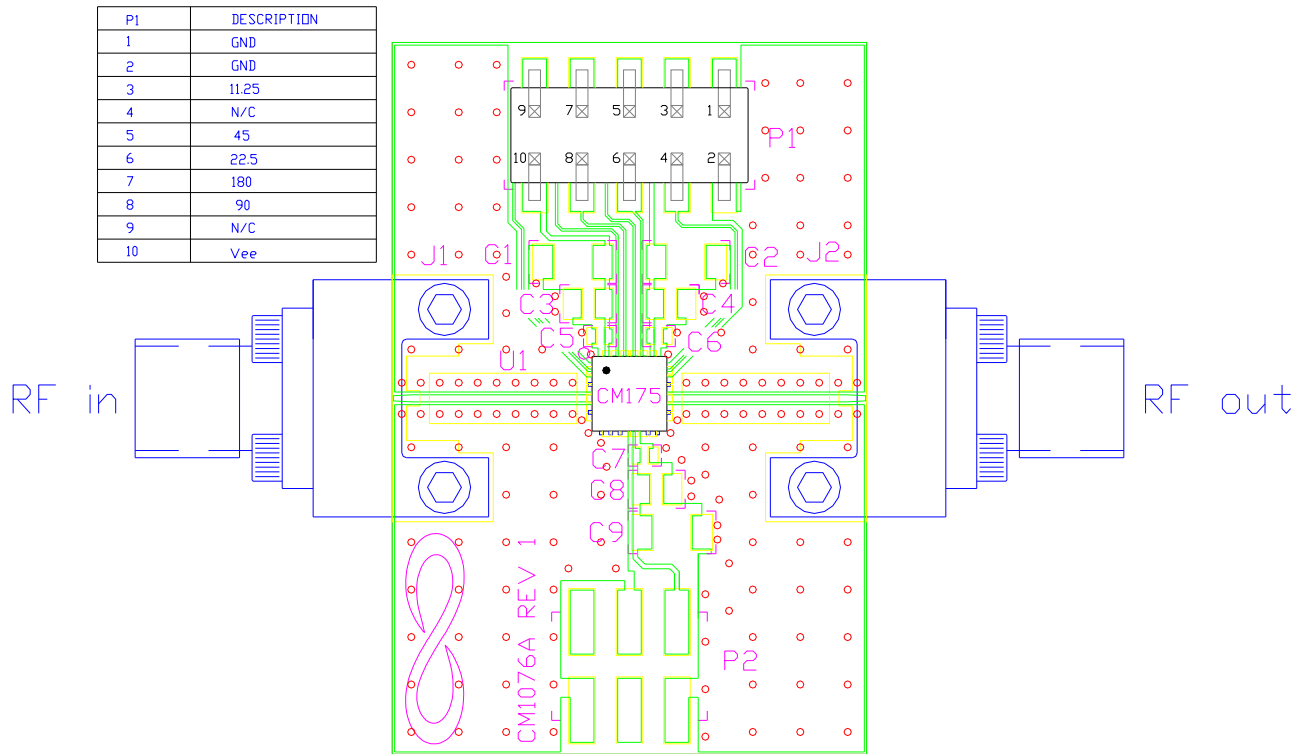

Bill of Material

Designator	Value	Description
J1, J2		SMA End Launch Connector
P1		10 Pin DC Header
U1		CMD175P4 5-Bit Phase Shifter
PCB		CM1076A Evaluation PCB

Handling Precautions

Parameter	Rating	Standard
ESD – Human Body Model (HBM)	Class 1A	ESDA / JEDEC JS-001-2012
MSL – Moisture Sensitivity Level	Level 1	JEDEC standard IPC/JEDEC J-STD-020



Caution!
 ESD-Sensitive Device

RoHS Compliance

This part is compliant with 2011/65/EU RoHS directive (Restrictions on the Use of Certain Hazardous Substances in Electrical and Electronic Equipment) as amended by Directive 2015/863/EU.

This product also has the following attributes:

- Lead Free
- Antimony Free
- TBBP-A (C₁₅H₁₂Br₄O₂) Free
- SVHC Free
- Halogen Free
- PFOS Free

Contact Information

For the latest specifications, additional product information, worldwide sales and distribution locations:

Web: www.qorvo.com

Tel: 1-844-890-8163

Email: customer.support@qorvo.com

Important Notice

The information contained in this Data Sheet and any associated documents (“Data Sheet Information”) is believed to be reliable; however, Qorvo makes no warranties regarding the Data Sheet Information and assumes no responsibility or liability whatsoever for the use of said information. All Data Sheet Information is subject to change without notice. Customers should obtain and verify the latest relevant Data Sheet Information before placing orders for Qorvo® products. Data Sheet Information or the use thereof does not grant, explicitly, implicitly or otherwise any rights or licenses to any third party with respect to patents or any other intellectual property whether with regard to such Data Sheet Information itself or anything described by such information.

DATA SHEET INFORMATION DOES NOT CONSTITUTE A WARRANTY WITH RESPECT TO THE PRODUCTS DESCRIBED HEREIN, AND QORVO HEREBY DISCLAIMS ANY AND ALL WARRANTIES WITH RESPECT TO SUCH PRODUCTS WHETHER EXPRESS OR IMPLIED BY LAW, COURSE OF DEALING, COURSE OF PERFORMANCE, USAGE OF TRADE OR OTHERWISE, INCLUDING THE IMPLIED WARRANTIES OF MERCHANTABILITY AND FITNESS FOR A PARTICULAR PURPOSE. Without limiting the generality of the foregoing, Qorvo® products are not warranted or authorized for use as critical components in medical, life-saving, or life-sustaining applications, or other applications where a failure would reasonably be expected to cause severe personal injury or death. Applications described in the Data Sheet Information are for illustrative purposes only. Customers are responsible for validating that a particular product described in the Data Sheet Information is suitable for use in a particular application.

© 2022 Qorvo US, Inc. All rights reserved. This document is subject to copyright laws in various jurisdictions worldwide and may not be reproduced or distributed, in whole or in part, without the express written consent of Qorvo US, Inc. | QORVO® is a registered trademark of Qorvo US, Inc.