

Product Description

Qorvo's QPA2598 is a packaged broadband driver amplifier fabricated on Qorvo's QGaN15 0.15 um GaN on SiC process. Operating from 6 to 12 GHz, the QPA2598 achieves 2.5 W output power with a Power Added Efficiency of 30 % and harmonic suppression of -30dBc. Under nominal bias, it provides 22 dB small signal gain and 16 dB of large signal power gain.

The QPA2598 is available in small form factor 4x4 mm overmold QFN which allows for easy system integration. The QPA2598 is an ideal choice to drive Qorvo's high performing GaN HPAs allowing the user to run both driver and HPA off the same voltage rail.

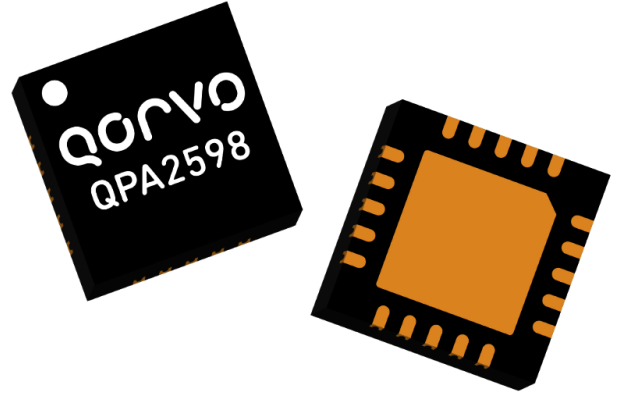

Product Features

- Frequency Range: 6 - 12 GHz
- Small Signal Gain: 23 dB (mid-band)
- Pout: 34 dBm ($P_{IN} = 18$ dBm)
- PAE: 30 % CW
- Power Gain: 16 dB ($P_{IN} = 18$ dBm)
- Harmonic Suppression -30 dBc (Pin = 18 dBm)
- IM3: - 30 dBc (24 dBm Pout/Tone)
- Input Return Loss: 10 dB
- Output Return Loss: 8 dB
- Bias: $V_D = 22$ V, $I_{DQ} = 55$ mA, $V_G = - 2.5$ V Typical
- Package Dimensions: 4.0 x 4.0 x 0.85 mm

Applications

- Commercial and military radar
- Communications
- Electronic Warfare (EW)

Functional Block Diagram

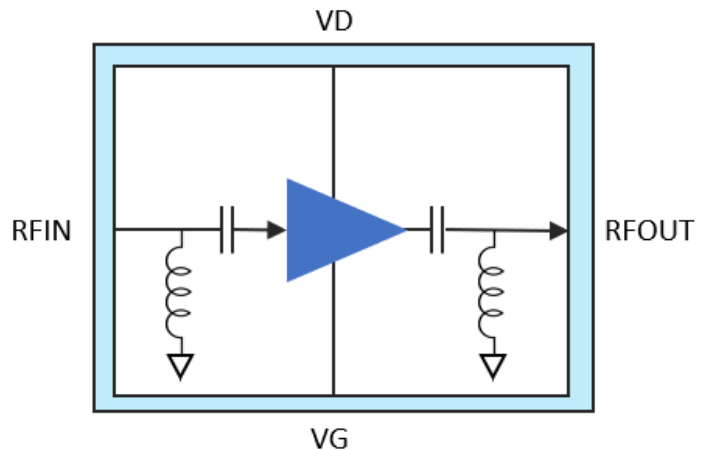

Ordering Information

Part No.	Description
QPA2598	Driver Amplifier, Waffle Pack, Qty 50
QPA2598TR7	Tape and Reel 7", Qty 500
QPA2598EVB	QPA2598 Evaluation Board, Qty 1

Recommended Operating Conditions

Parameter	Min	Typ	Max	Units
Drain Voltage (V_D)		22		V
Drain Current (I_{DQ})		55		mA
Drain Current Under RF Drive (I_{D_DRIVE})		See plots		mA
Gate Voltage (V_G , typical)		-2.5		V
Gate Current Under RF Drive (I_{G_DRIVE})		See plots		mA
Operation Temperature	-40		+85	°C

Electrical performance is measured under conditions noted in the electrical specifications table. Specifications are not guaranteed over all recommended operating conditions.

Electrical Specifications

Parameter	Min	Typ	Max	Units
Operational Frequency Range	6		12	GHz
Small Signal Gain (from 6 to 9 GHz)		24		dB
Small Signal Gain (from 10 to 12 GHz)		22		dB
Input Return Loss		-10		dB
Output Return Loss		-8		dB
Output Power (at $P_{in} = 18$ dBm)		34		dBm
Power Added Efficiency (at $P_{in} = 18$ dBm)		30		%
Power Gain (at $P_{in} = 18$ dBm)		16		dB
HarmonicSuppressions (2nd at $P_{in} = 18$ dBm)		-30		dBc
IM3 (at $P_{out}/tone = 24$ dBm/Tone)		-30		dBc
Small Signal Gain Temperature Coefficient		-0.047		dB/°C
Gate Leakage Current ($V_D = 10$ V, $V_G = -3.7$ V)	-1.2	-0.5	0	mA

Test conditions unless otherwise noted: $V_D = +22$ V, $I_{DQ} = 55$ mA, $V_G = -2.5$ V typical, CW Mode, 25 °C
Data de-embedded to reference planes

Absolute Maximum Ratings

Parameter	Min Value	Max Value	Units
Drain Voltage (V_D)	-	29.6	V
Gate Voltage Range (V_G)	-8	+1	V
Drain Current (I_D)	-	0.65	A
Gate Current (I_G)	-10	50	mA
Power Dissipation (P_{DISS}), 85 °C	-	9.8	W
Input Power (P_{IN}), CW, 50 Ω , 85 °C,	-	23	dBm
Mounting Temperature (30 Seconds)	-	260	°C
Storage Temperature	-55	150	°C

Operation of this device outside the parameter ranges given above may cause permanent damage. These are stress ratings only, and functional operation of the device at these conditions is not implied. Extended application of Absolute Maximum Rating conditions to the device may reduce device reliability.

Thermal and Reliability Information

Parameter	Values	Units	Conditions
Under Drive, Thermal Resistance (θ_{JC}) ^(1,2,3)	10.98	°C/W	$T_{BASE} = 85\text{ °C}$, $V_D = +22\text{ V}$, CW Freq = 10 GHz, $I_{D_DRIVE} = 394\text{ mA}$ $P_{IN} = +18\text{ dBm}$, $P_{OUT} = +34\text{ dBm}$, $P_{DISS} = 6.18\text{ W}$
Channel Temperature (T_{CH})	152.86	°C	

Notes:

1. Thermal resistance is referenced to package backside
2. Base or ambient temperature is 85 °C
3. Refer to the following document: [GaN Device Channel Temperature, Thermal Resistance, and Reliability Estimates](#)

Performance Plots – Small Signal

Test conditions unless otherwise specified: $V_D = 22\text{ V}$, $I_{DQ} = 55\text{ mA}$, $V_G = -2.5\text{ V}$ Typical, $25\text{ }^\circ\text{C}$

Input Return Loss vs Temperature

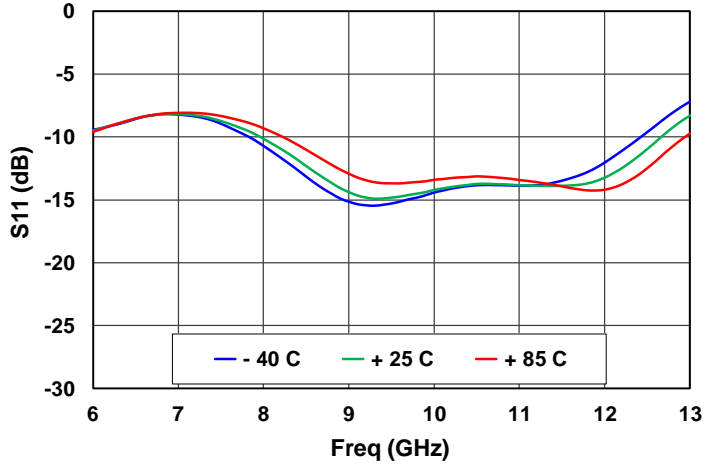

Gain vs Temperature

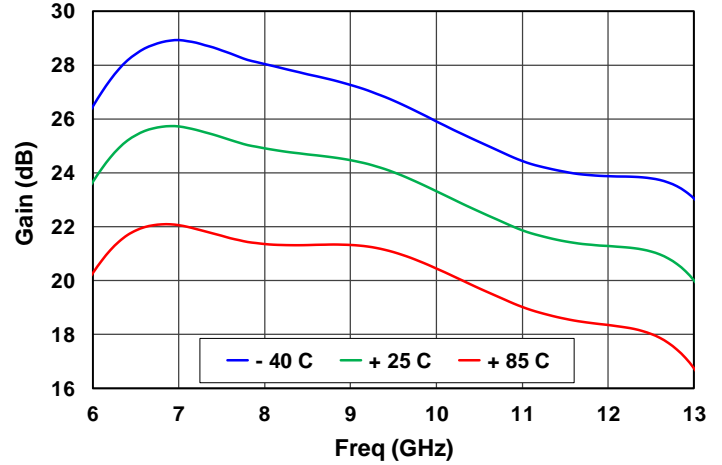

Reverse Isolation vs Temperature

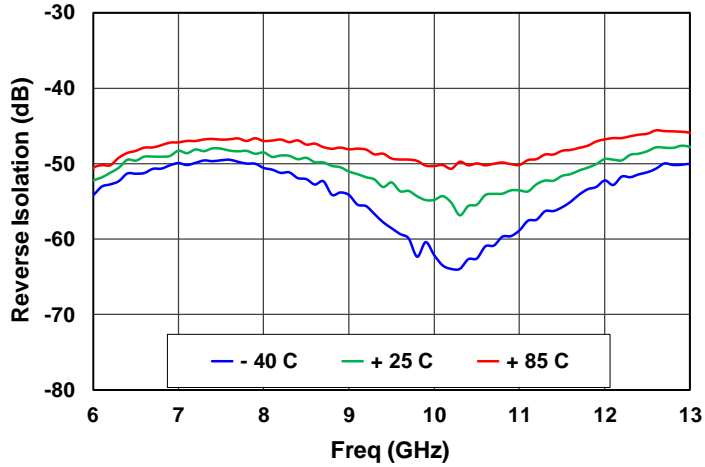

Output Return Loss vs Temperature

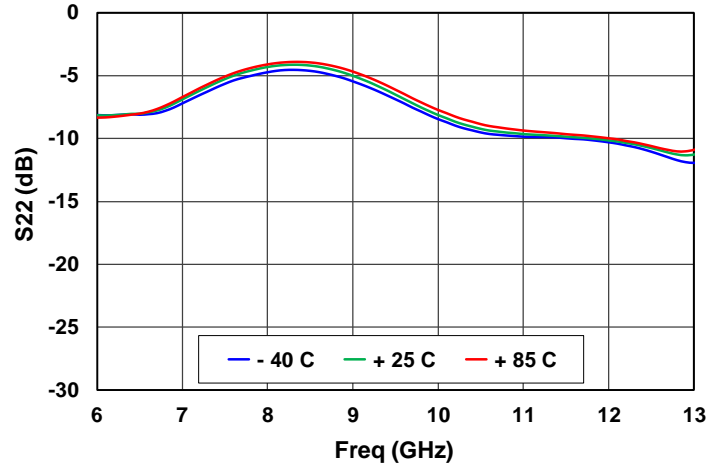

Performance Plots – Small Signal

Test conditions unless otherwise specified: $V_D = 22\text{ V}$, $I_{DQ} = 55\text{ mA}$, $V_G = -2.5\text{ V}$ Typical, $25\text{ }^\circ\text{C}$

Gain vs Voltage

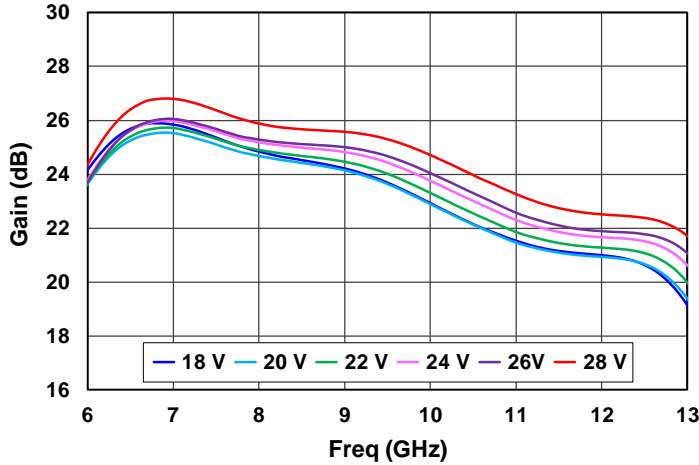

Gain vs Current

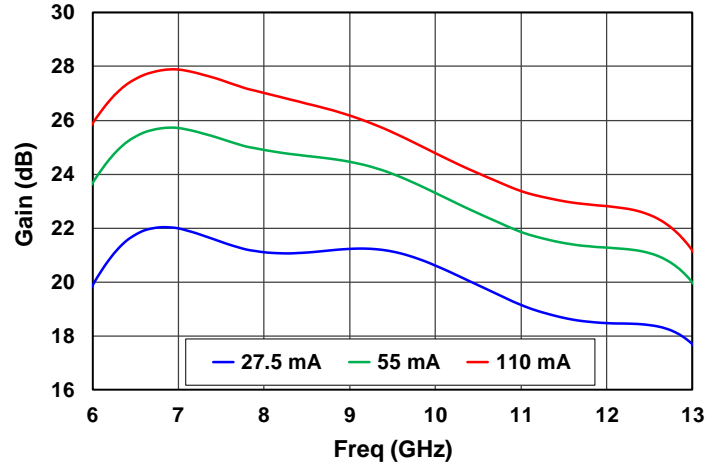

Input Return Loss vs Voltage

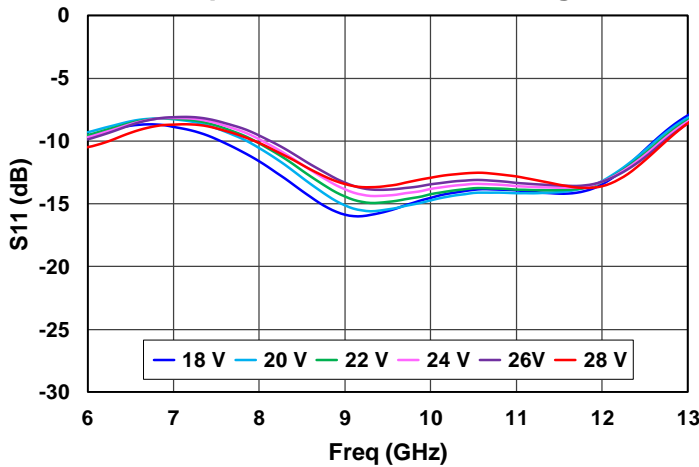

Input Return Loss vs Current

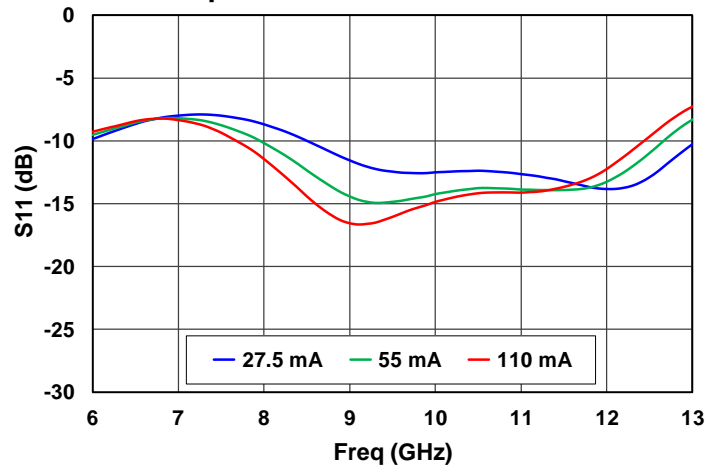

Output Return Loss vs Voltage

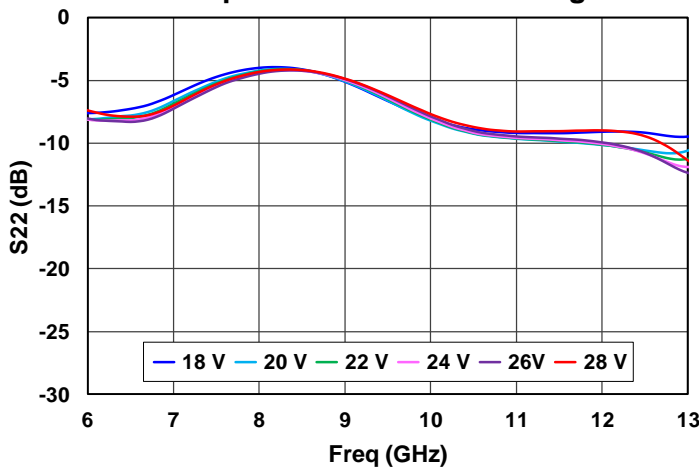

Output Return Loss vs Current

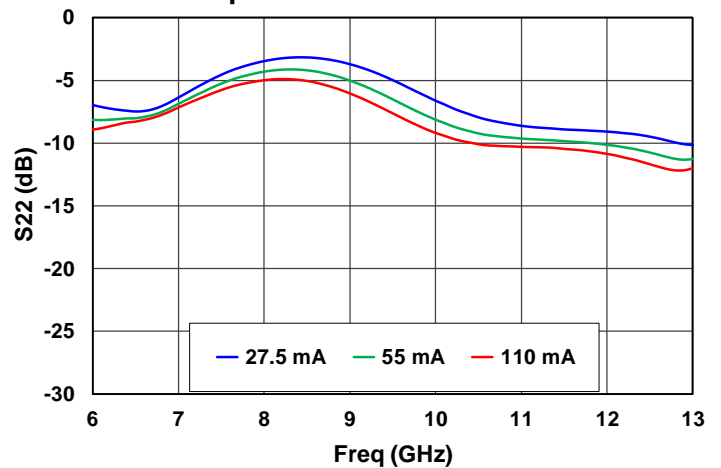

Performance Plots – Large Signal

Test conditions unless otherwise specified: $V_D = 22\text{ V}$, $I_{DQ} = 55\text{ mA}$, $P_{in} = 18\text{ dBm}$, $V_G = -2.5\text{ V}$ Typical, CW, $25\text{ }^\circ\text{C}$

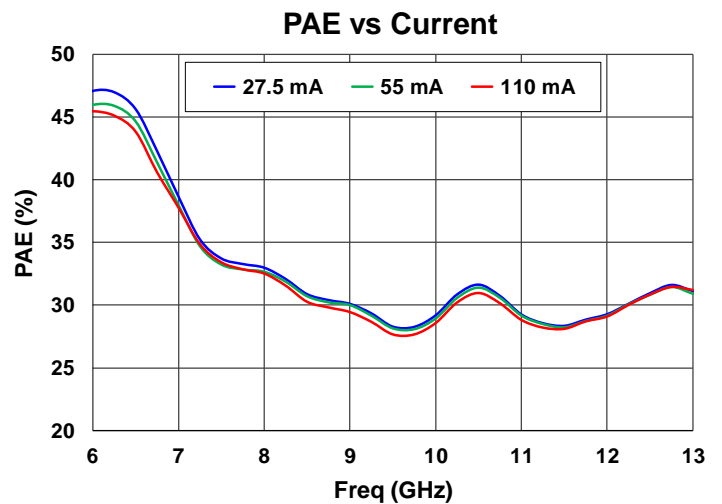
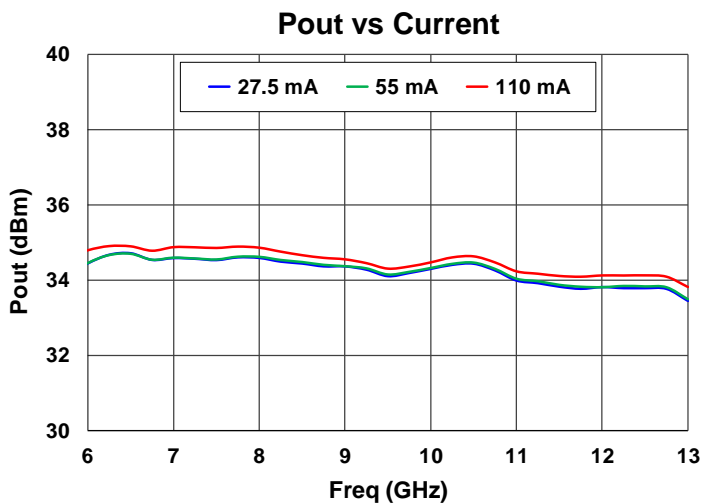
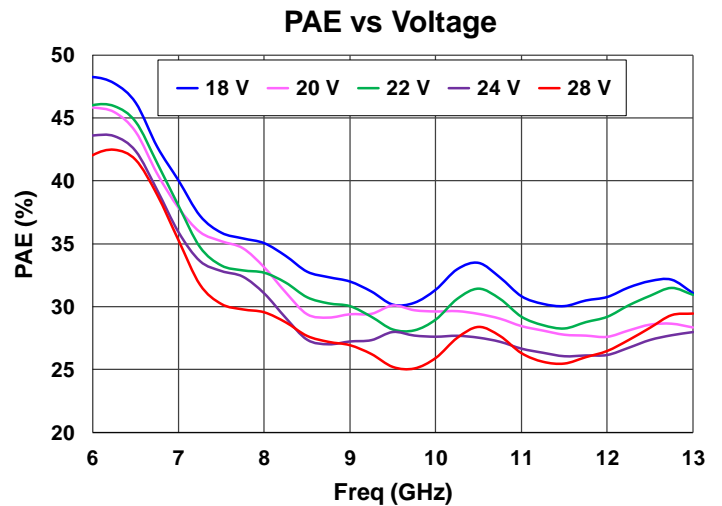
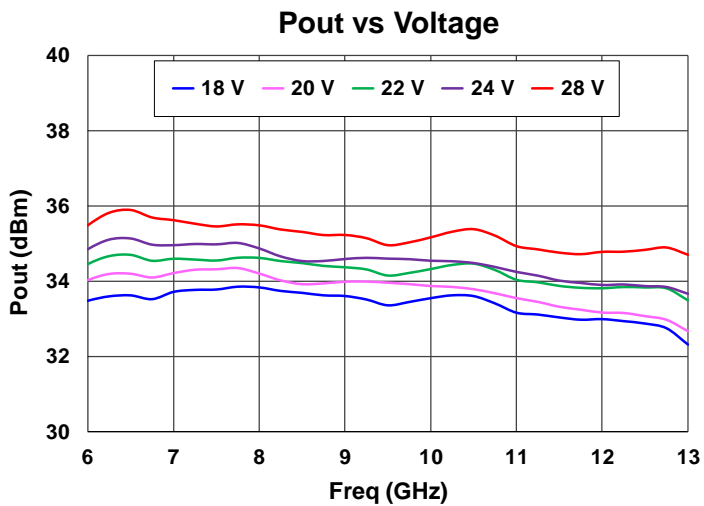
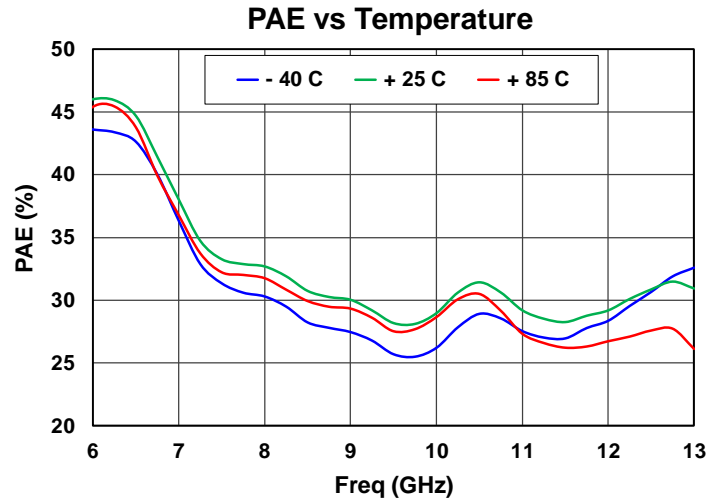
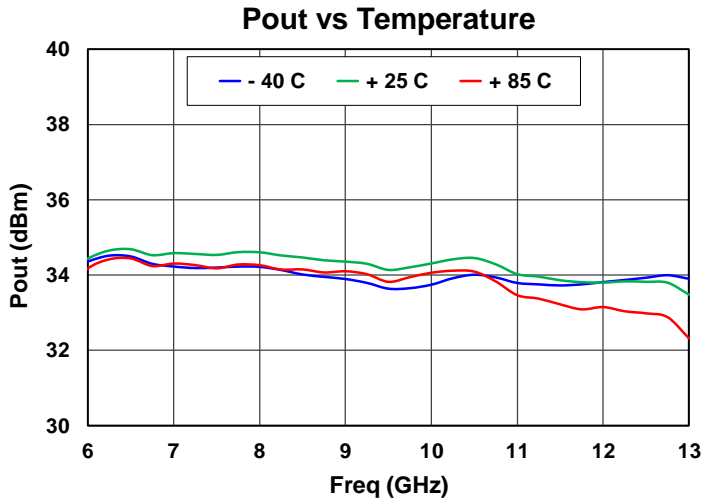

Performance Plots – Large Signal

Test conditions unless otherwise specified: $V_D = 22\text{ V}$, $I_{DQ} = 55\text{ mA}$, $V_G = -2.5\text{ V}$ Typical, CW, $25\text{ }^\circ\text{C}$

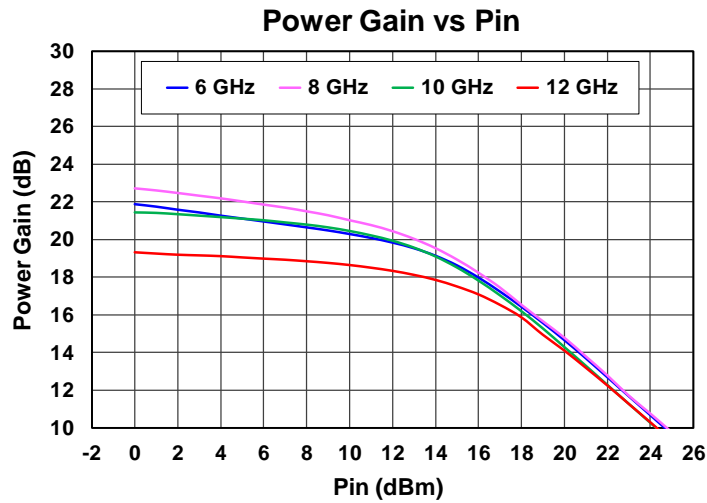
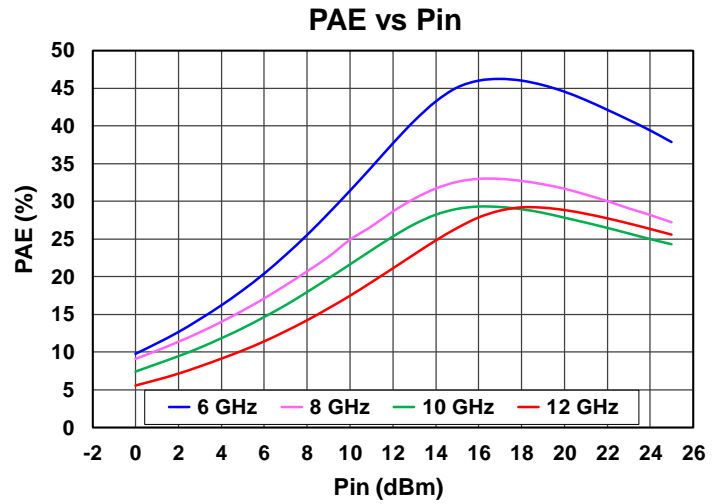
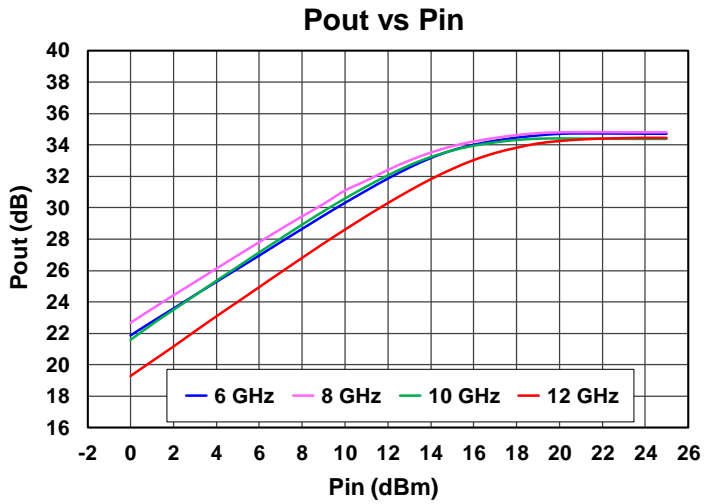

Performance Plots – Large Signal

Test conditions unless otherwise specified: $V_D = 22\text{ V}$, $I_{DQ} = 55\text{ mA}$, $V_G = -2.5\text{ V}$ Typical, CW, $25\text{ }^\circ\text{C}$

P1dB vs Temperature

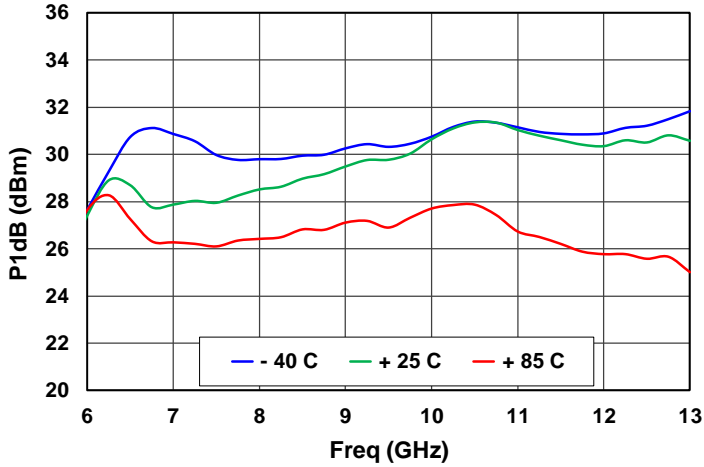

Power Gain vs Temperature

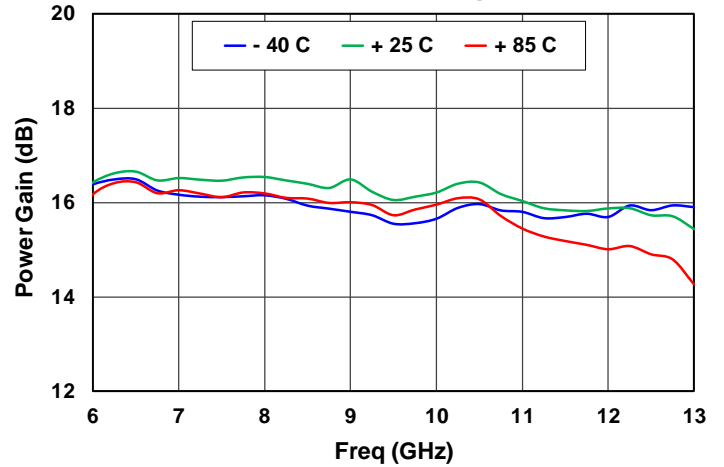

P1dB vs Voltage

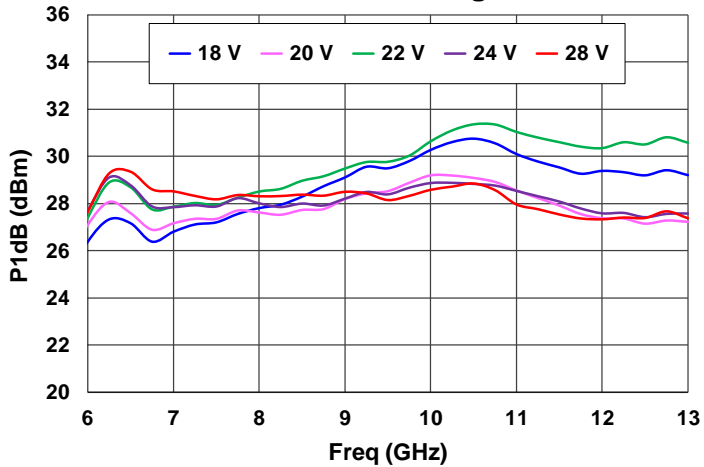

Power Gain vs Voltage

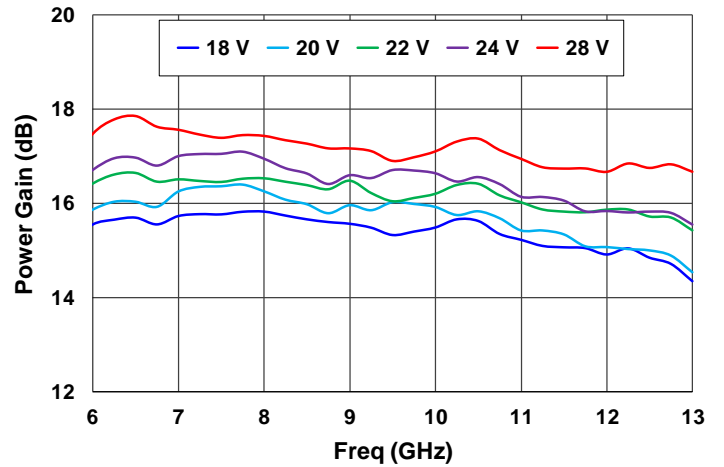

P1dB vs Current

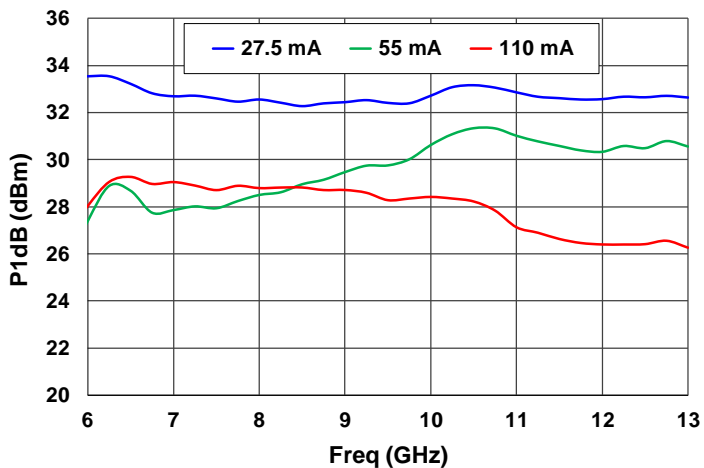

Power Gain vs Current

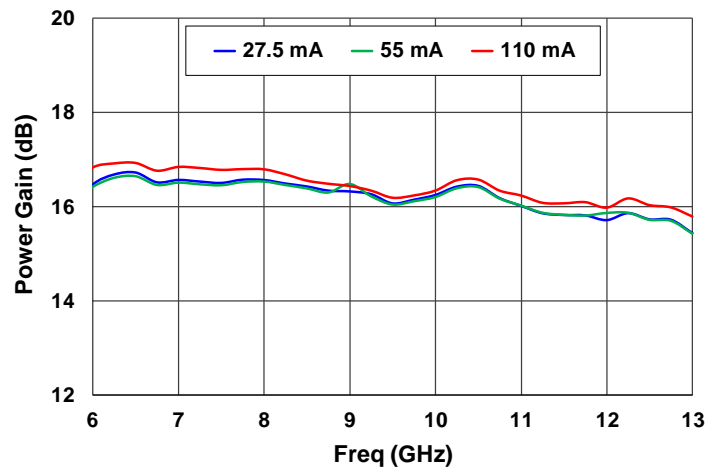

Performance Plots – Large Signal

Test conditions unless otherwise specified: $V_D = 22\text{ V}$, $I_{DQ} = 55\text{ mA}$, $V_G = -2.5\text{ V}$ Typical, CW, $25\text{ }^\circ\text{C}$

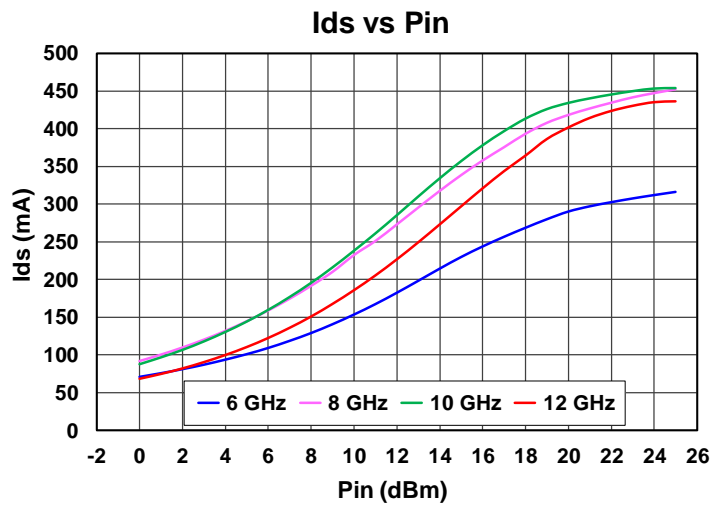
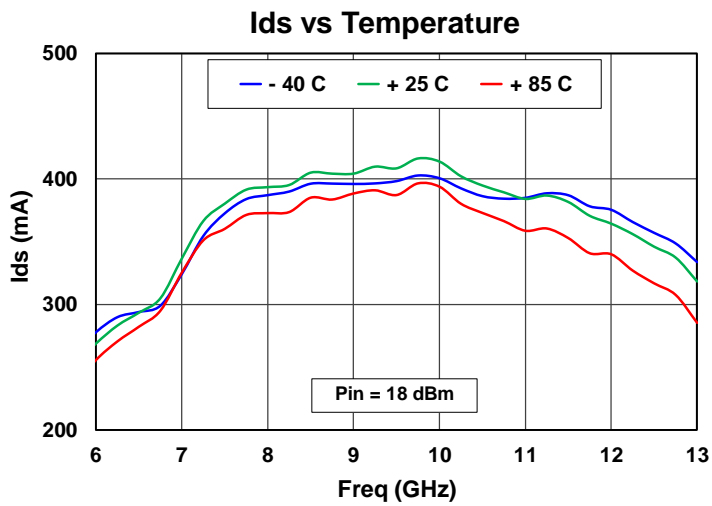
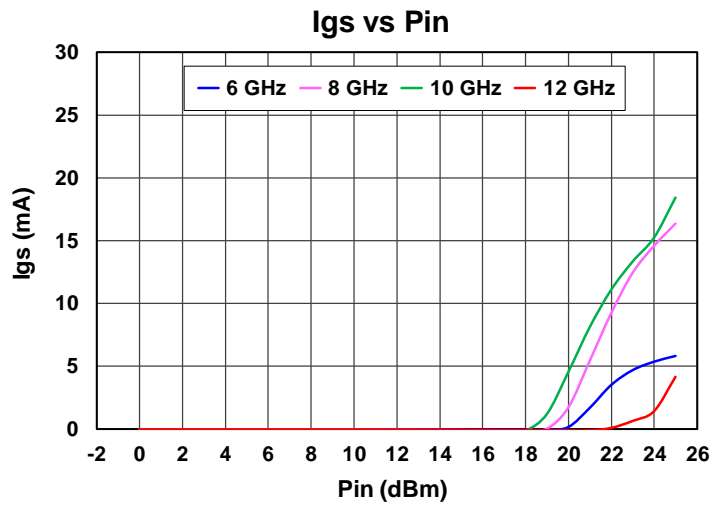
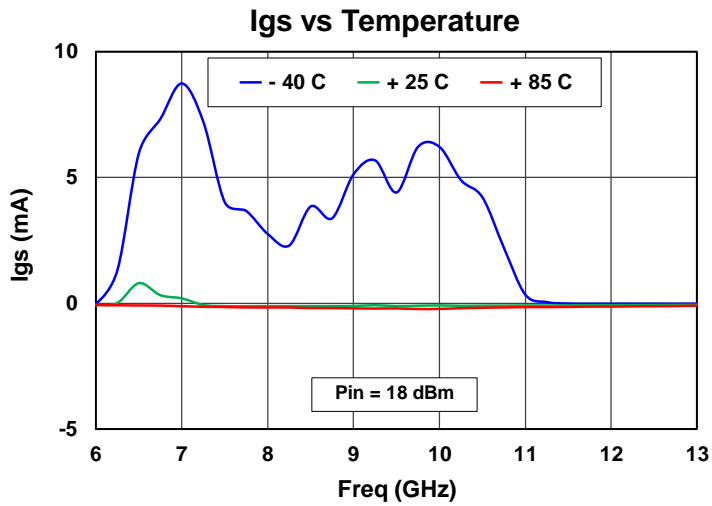

Performance Plots – Harmonics

Test conditions unless otherwise specified: $V_D = 22\text{ V}$, $I_{DQ} = 55\text{ mA}$, $V_G = -2.5\text{ V}$ Typical, $P_{in} = 18\text{ dBm}$, $25\text{ }^\circ\text{C}$

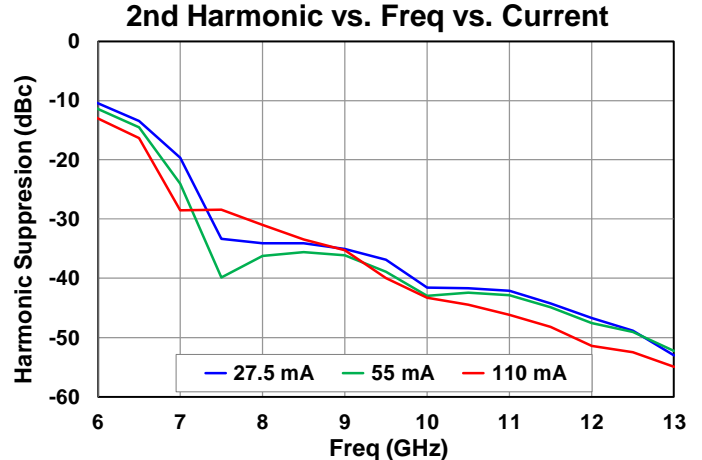
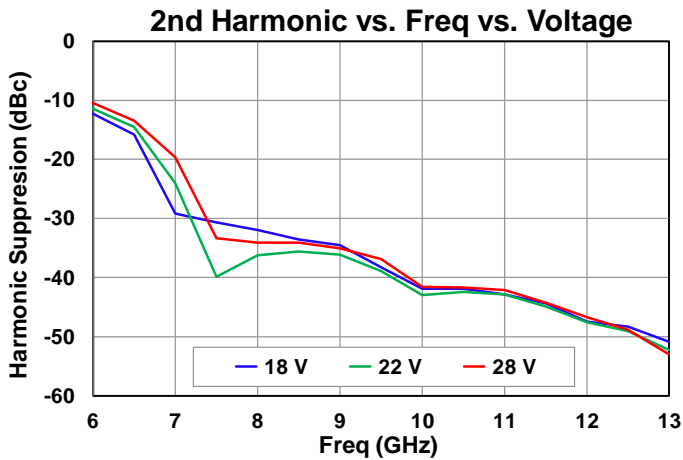
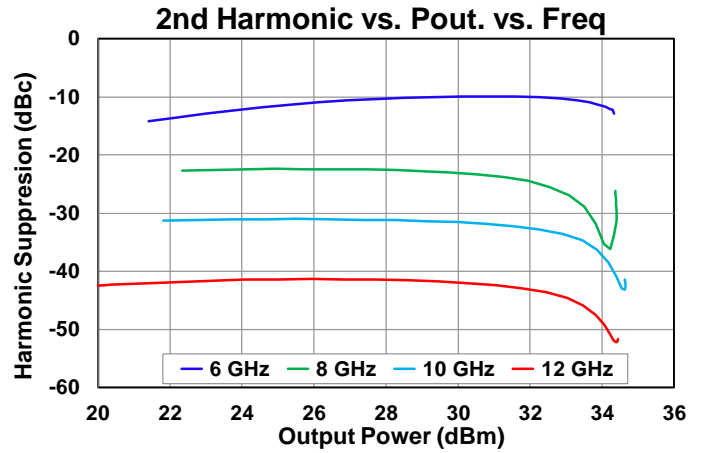
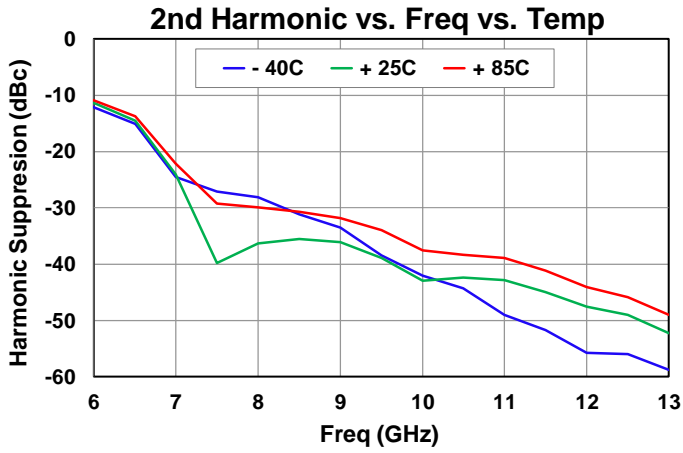

Performance Plots – Harmonics

Test conditions unless otherwise specified: $V_D = 22\text{ V}$, $I_{DQ} = 55\text{ mA}$, $V_G = -2.5\text{ V}$ Typical, $P_{in} = 18\text{ dBm}$, $25\text{ }^\circ\text{C}$

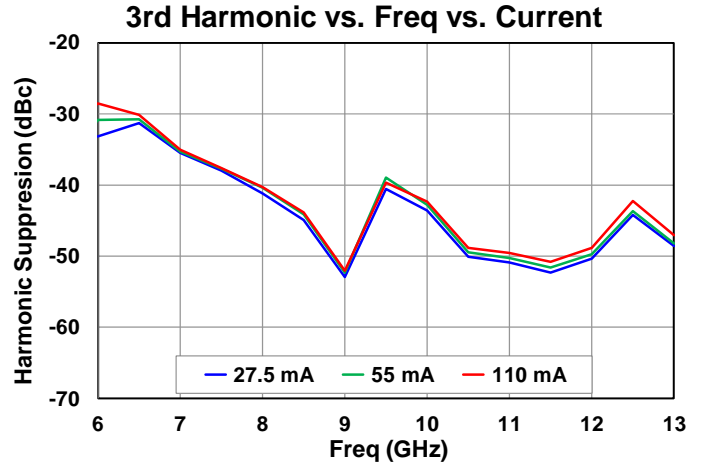
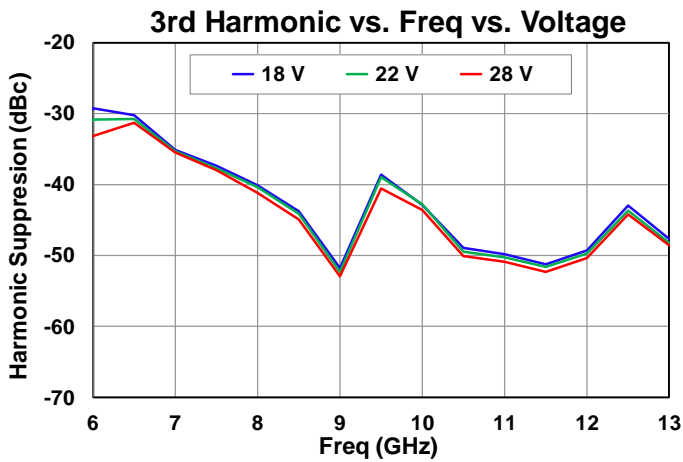
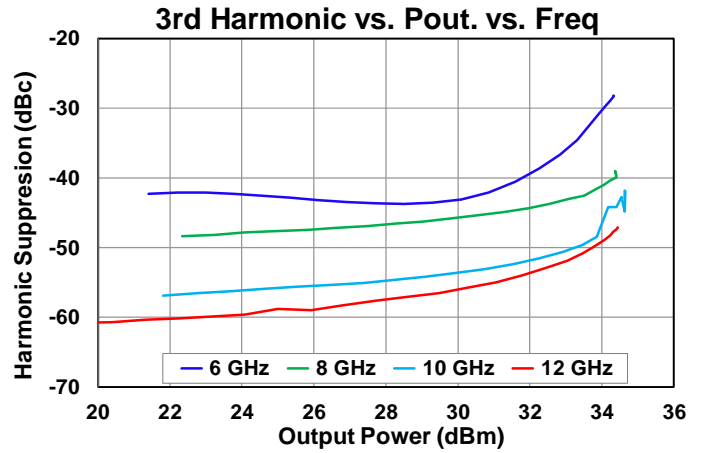
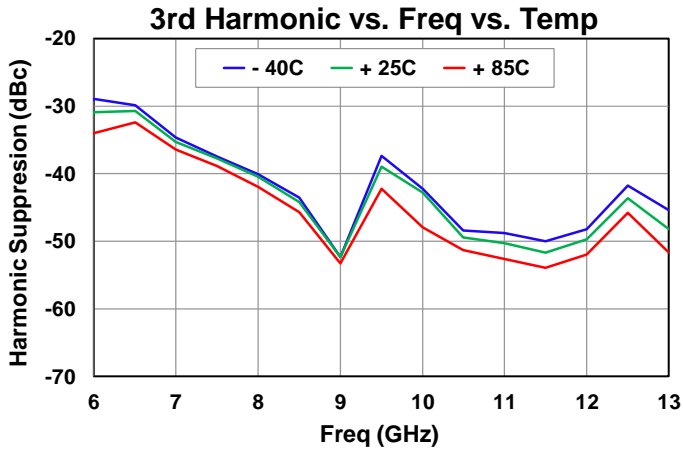

Performance Plots – Linearity

Test conditions unless otherwise specified: $V_D = 22\text{ V}$, $I_{DQ} = 55\text{ mA}$, $V_G = -2.5\text{ V}$ Typical, Tone Spacing = 10 MHz, 25 °C

Output TOI vs Temperature

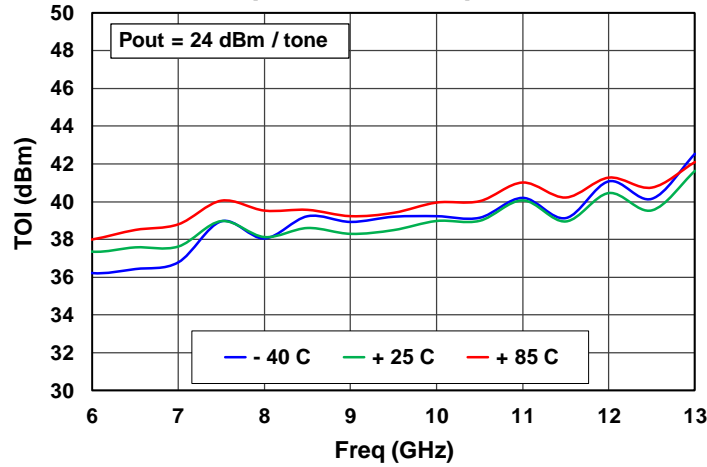

Output TOI vs Voltage

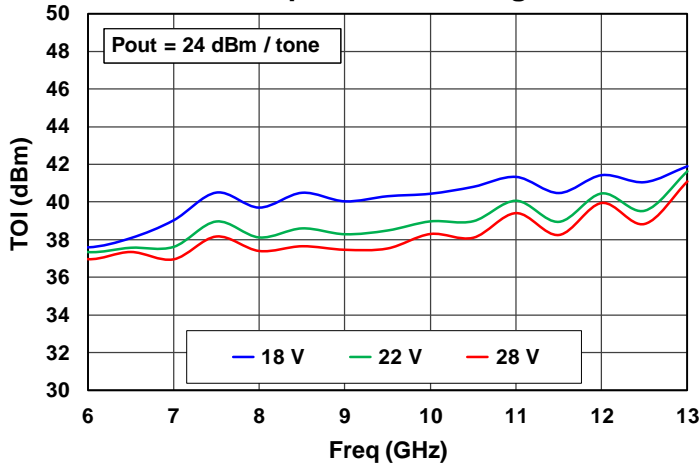

Output TOI vs Current

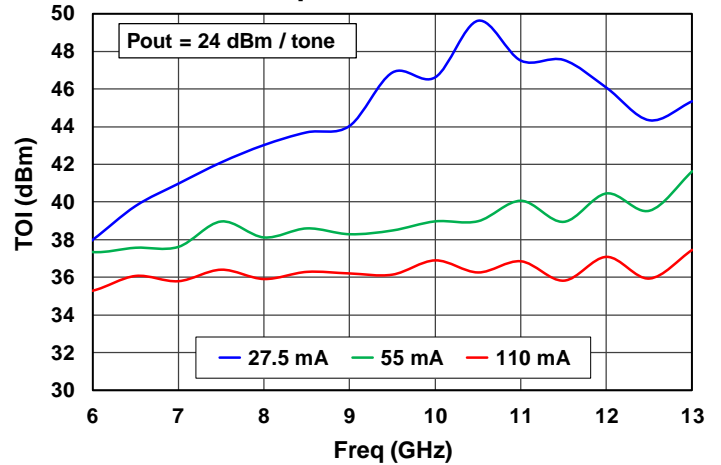

IMD3 vs Pout

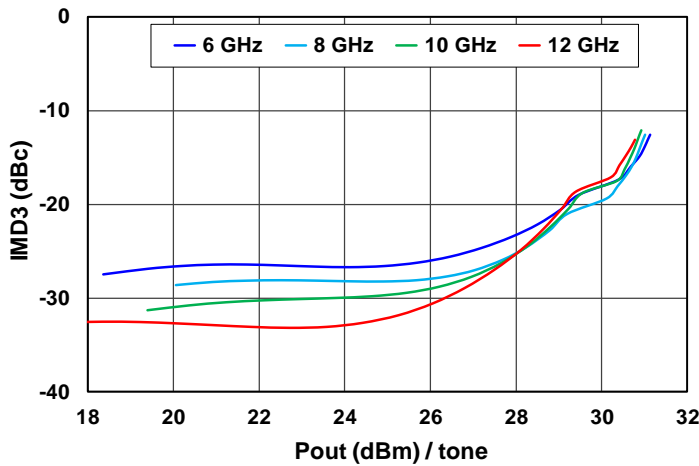

IMD5 vs Pout

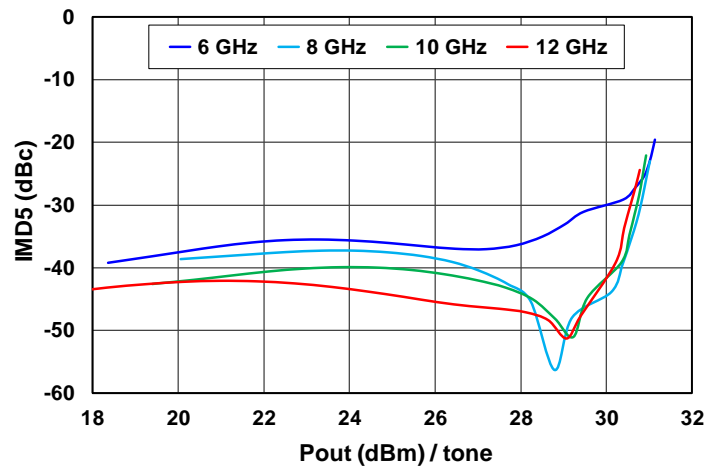

Application Circuit

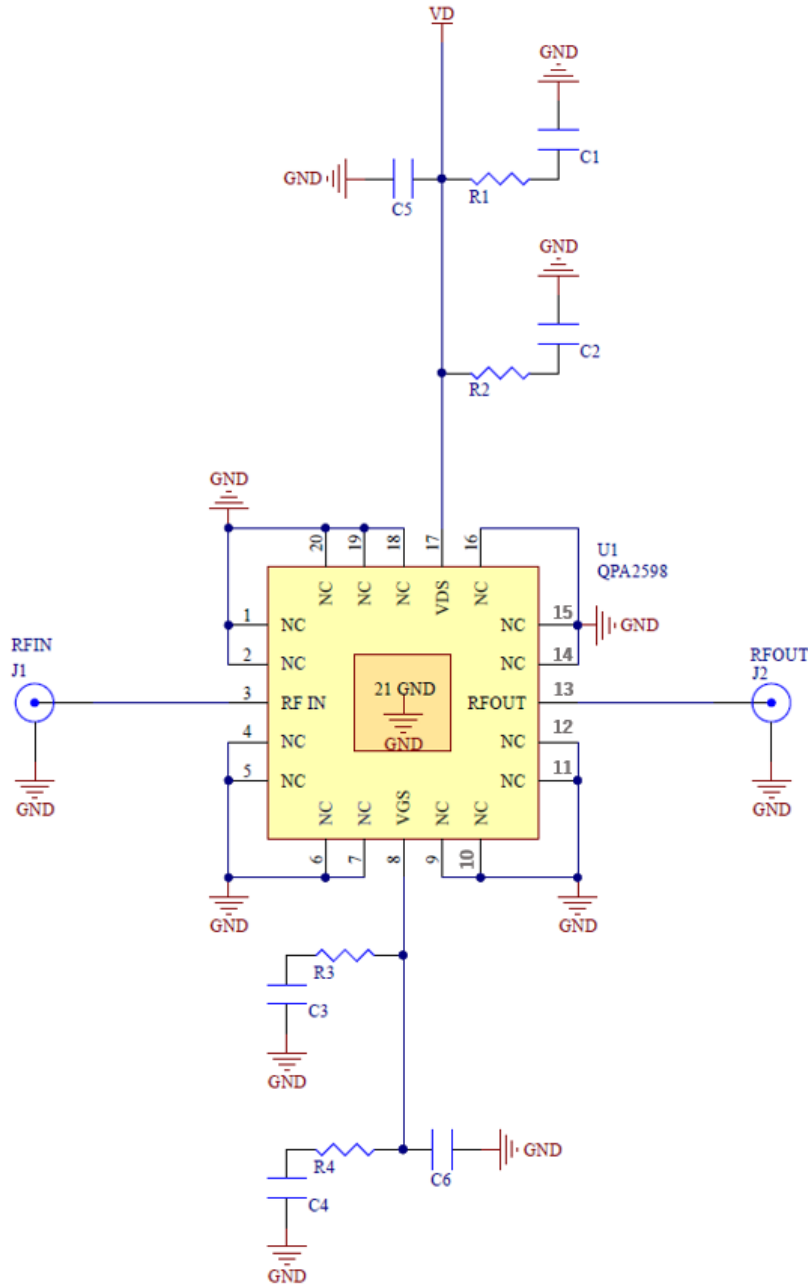

Bias Up Procedure

1. Set I_D limit to 650 mA, I_G limit to 50 mA
2. Apply -5 V to V_G
3. Apply $+22$ V to V_D ; ensure I_{DQ} is approx. 0 mA
4. Adjust V_G until $I_{DQ} = 55$ mA ($V_G \sim -2.5$ V Typ.).
5. Turn on RF

Bias Down Procedure

1. Turn off RF
2. Reduce V_G to -5 V; ensure I_{DQ} is approx. 0 mA
3. Set V_D to 0 V
4. Turn off V_D supply
5. Turn off V_G supply

EVB and BOM

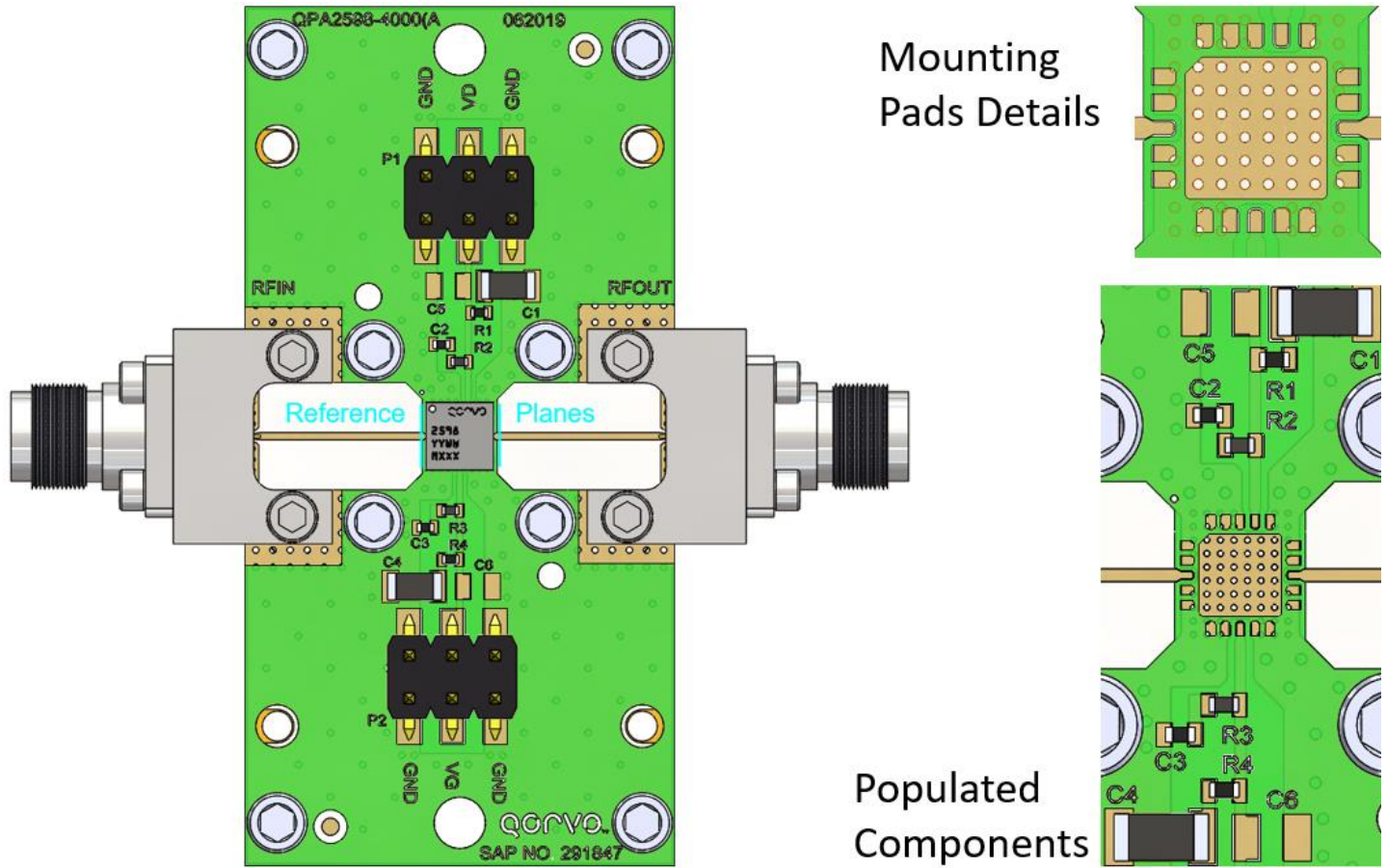

PCB core material is Rogers Corp. RO4003C, RF Layer is 0.008" thick, $\epsilon_r = 3.38$. Metal layers are 0.5 oz. copper. The microstrip line at the connector interface is optimized for the Southwest Microwave end launch connector 1092-01A-5.

The trace pattern shown has been developed and tested for optimized assembly at Qorvo. The PCB land pattern has been developed to accommodate lead tolerances. Since processes vary from company to company, careful process development is recommended.

Bill of Materials

Reference Des.	Value	Description	Manuf.	Part Number
C1, C4	10 μ F	Cap, 1206, X5R	Various	
C2, C3	1000 pF	Cap, 0402, X7R	Various	
R1, R4	0 Ohms	Resistor, 1/10 W, 0402	Various	
R2, R3	1.8 Ohms	Resistor, 1/10 W, 5%, 0402	Various	
J1, J2	-	2.92 MM RF CONNECTOR	Southwest Microwave	1092-01A-5

Pin Configuration and Description

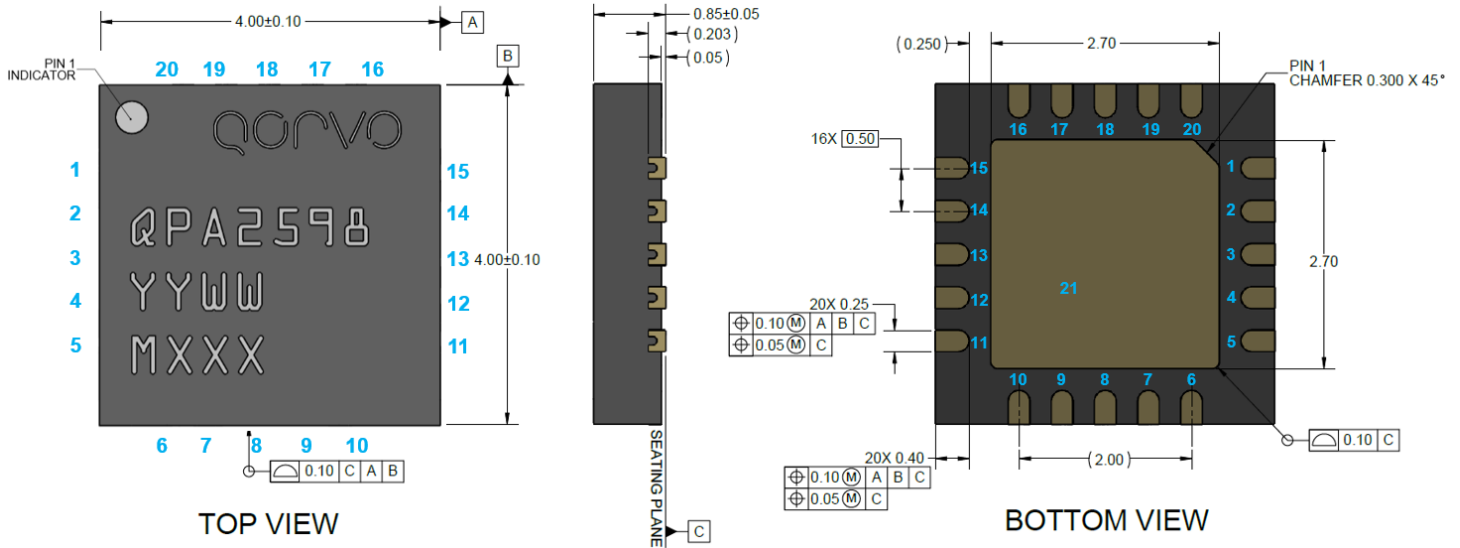

Dimensions in mm, Package is mold encapsulated with NiPdAu plated leads

Part Marking: QPA2598: Part Number, YY = Part Assembly Year, WW = Part Assembly Week, MXXX = Batch ID

Pin No.	Label	Description
1, 2, 4 - 7, 9 - 12, 14 - 16, 18 - 20	NC	No internal connection, can be grounded
3	RFIN	Input; Matched to 50 Ω; DC grounded
8	V _G	Gate Voltage; Bias network required; see recommended application circuit
13	RFOUT	Output; Matched to 50 Ω; DC grounded
17	V _D	Drain voltage; Bias network is required, see recommended application circuit
21	GND	Slug ground

Solderability

- Compatible with the latest version of J-STD-020, Lead-free solder, 260 °C.

Recommended Soldering Temperature Profile

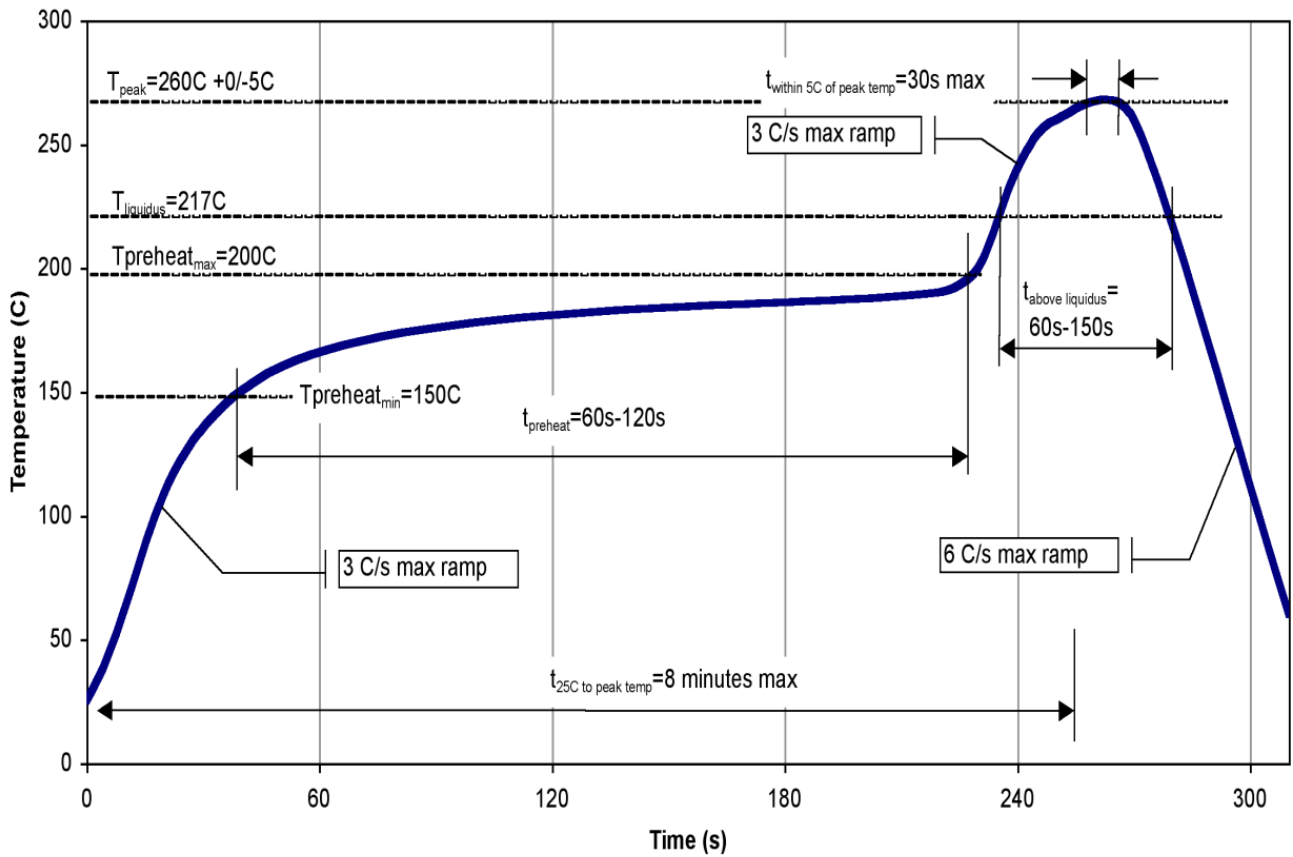

Handling Precautions

Parameter	Rating	Standard
ESD – Human Body Model (HBM)	1A	ESDA / JEDEC JS-001-2017
ESD – Charged Device Model (CDM)	C3	ESDA / JEDEC JS-002-2014
MSL – Convection Reflow 260 °C	3	JEDEC standard IPC/JEDEC J-STD-020



Caution!
ESD-Sensitive Device

RoHS Compliance

This product is compliant with the 2011/65/EU RoHS directive (Restrictions on the Use of Certain Hazardous Substances in Electrical and Electronic Equipment), as amended by Directive 2015/863/EU. This product also has the following attributes:

- Lead Free
- Halogen Free (Chlorine, Bromine)
- Antimony Free
- TBBP-A (C₁₅H₁₂Br₄O₂) Free
- SVHC Free
- PFOS Free

Contact Information

For the latest specifications, additional product information, worldwide sales and distribution locations:

Tel: 1-844-890-8163

Web: www.qorvo.com

Email: customer.support@qorvo.com

Important Notice

The information contained herein is believed to be reliable; however, Qorvo makes no warranties regarding the information contained herein and assumes no responsibility or liability whatsoever for the use of the information contained herein. All information contained herein is subject to change without notice. Customers should obtain and verify the latest relevant information before placing orders for Qorvo products. The information contained herein or any use of such information does not grant, explicitly or implicitly, to any party any patent rights, licenses, or any other intellectual property rights, whether with regard to such information itself or anything described by such information. **THIS INFORMATION DOES NOT CONSTITUTE A WARRANTY WITH RESPECT TO THE PRODUCTS DESCRIBED HEREIN, AND QORVO HEREBY DISCLAIMS ANY AND ALL WARRANTIES WITH RESPECT TO SUCH PRODUCTS WHETHER EXPRESS OR IMPLIED BY LAW, COURSE OF DEALING, COURSE OF PERFORMANCE, USAGE OF TRADE OR OTHERWISE, INCLUDING THE IMPLIED WARRANTIES OF MERCHANTABILITY AND FITNESS FOR A PARTICULAR PURPOSE.**

Without limiting the generality of the foregoing, Qorvo products are not warranted or authorized for use as critical components in medical, life-saving, or life-sustaining applications, or other applications where a failure would reasonably be expected to cause severe personal injury or death.

© 2021 Qorvo US, Inc. All rights reserved. This document is subject to copyright laws in various jurisdictions worldwide and may not be reproduced or distributed, in whole or in part, without the express written consent of Qorvo US, Inc. | QORVO® is a registered trademark of Qorvo US, Inc.

Mouser Electronics

Authorized Distributor

Click to View Pricing, Inventory, Delivery & Lifecycle Information:

[Qorvo:](#)

[QPA2598EVB](#) [QPA2598](#) [QPA2598TR7](#)