



# TGL2209–SM

## 8–12 GHz 50 Watt VPIN Limiter

### Product Overview

The Qorvo TGL2209–SM is a high power, X-band GaAs VPIN limiter capable of protecting sensitive receive channel components against high power incident signals. The TGL2209–SM does not require DC bias and achieves a low insertion loss in a small form factor. These features allow for simple integration with minimal impact to system performance.

The TGL2209–SM operates from 8.0–12 GHz with low insertion loss of less than 0.5 dB. Receive protection is rated up to 50 W incident pulsed-power with a low flat leakage of less than 18.5 dBm.

The TGL2209–SM is offered as a packaged limiter and is well suited for both commercial and defense related applications.

Lead-free and RoHS compliant.

### Functional Block Diagram

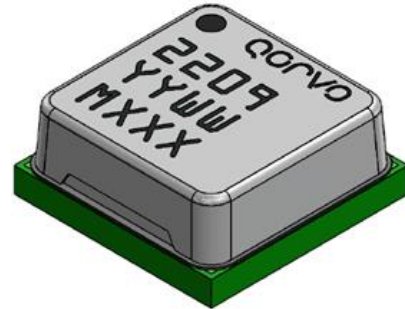
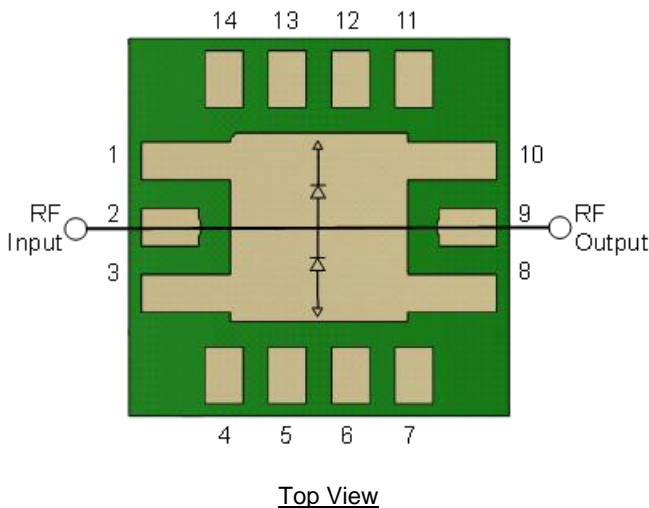

14 Pad 4 x 4 mm QFN Package

### Key Features

- Frequency Range: 8.0 to 12.0 GHz
- Insertion Loss: < 0.5 dB
- Peak Power Handling: 50 W (pulsed)
- Flat Leakage: < 18.5 dBm
- Spike Leakage < 20.5 dBm
- Passive (no DC bias required)
- Recovery time < 30 ns
- Package Dimensions: 4.00 x 4.00 x 1.54 mm

*Performance is typical across frequency. Please reference electrical specification table and data plots for more details.*

### Applications

- Receive Chain Protection
- Commercial and Military Radar

### Ordering Information

Part	Description
TGL2209–SM	8.0–12.0 GHz 50W VPIN Limiter
TGL2209–SMEVBP01	8.0–12.0 GHz 50W VPIN Limiter Evaluation Board

## Absolute Maximum Ratings

Parameter	Rating
Incident Power, Pulsed <sup>1</sup> , 50 Ω, 25 °C	47 dBm
Incident Power, Pulsed <sup>1</sup> , 50 Ω, 85 °C	46 dBm
Incident Power, CW, 50 Ω, 25 °C	40 dBm
Incident Power, CW, 50 Ω, 85 °C	36 dBm
Mounting Temperature (30 s max)	260 °C
Storage Temperature	-40 to 150 °C

Note:

<sup>1</sup> Pulse conditions: PW = 100 us, Duty Cycle = 10%

Exceeding any one or a combination of the Absolute Maximum Rating conditions may cause permanent damage to the device. Extended application of Absolute Maximum Rating conditions to the device may reduce device reliability.

## Electrical Specifications

Parameter	Conditions <sup>(1)</sup>	Min	Typ	Max	Units
Operational Frequency Range		8.0		12.0	GHz
Insertion Loss	8 GHz		0.35	0.75	dB
	9 GHz		0.35	0.75	
	10 GHz		0.35	0.90	
	11 GHz		0.36	1.00	
	12 GHz		0.40	1.00	
Input Return Loss	8 GHz		24		dB
	10 GHz		25		
	12 GHz		19		
Output Return Loss	8 GHz		24		dB
	10 GHz		29		
	12 GHz		20		
Flat Leakage Power at P <sub>IN</sub> > 30 dBm (Pulse)	8 GHz		18.0		dBm
	10 GHz		17.5		
	12 GHz		18.5		
Pulse Recovery Time			<30		ns
Spike Leakage			20.5		dBm
Insertion Loss Temperature Coefficient			0.006		dB/ °C

Notes:

1. Test conditions unless otherwise noted: Temp = +25 °C, 50 Ω system.

## Thermal and Reliability Information

Parameter	Test Conditions	Value	Units
Incident Power (RF Operational Life Test <sup>(1)</sup> )	10 GHz Pulsed, PW=100 us, DC=10%, 50 Ω, 25 °C	50	W

Notes:

1. Test terminated after 100 hours.

**Performance Plots – Small Signal**

Test conditions unless otherwise noted: Temp.=+25 °C

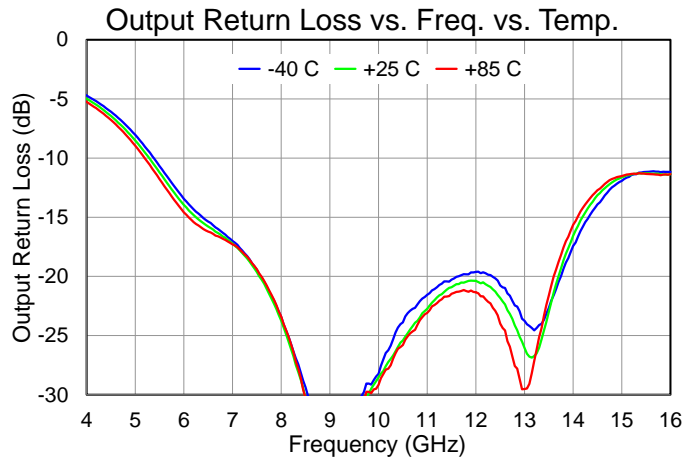
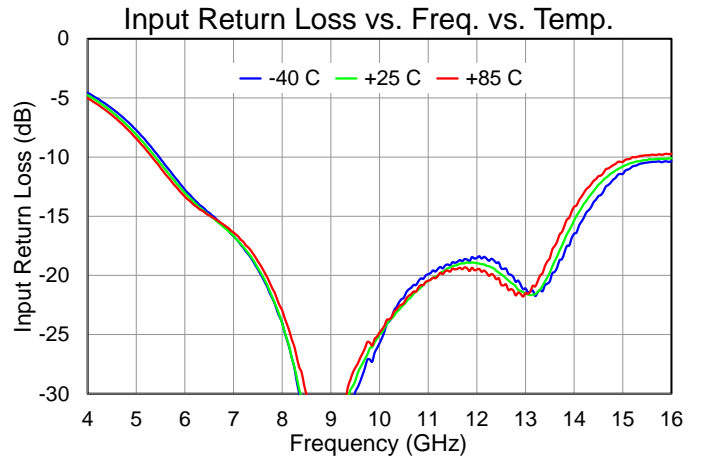
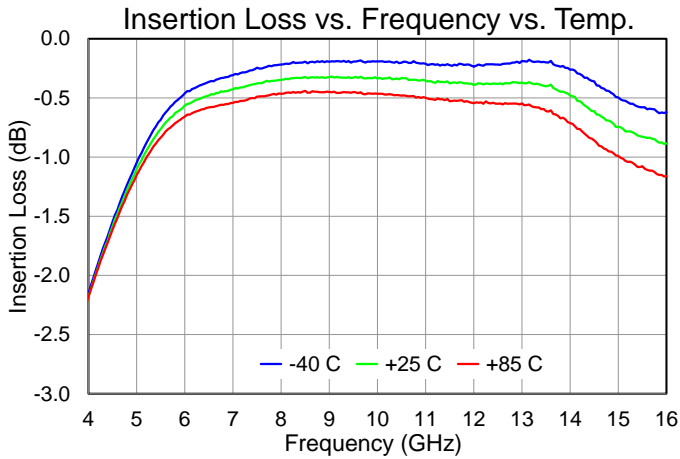

## Performance Plots – Large Signal

Test conditions unless otherwise noted: CW power, Temp.=+25 °C

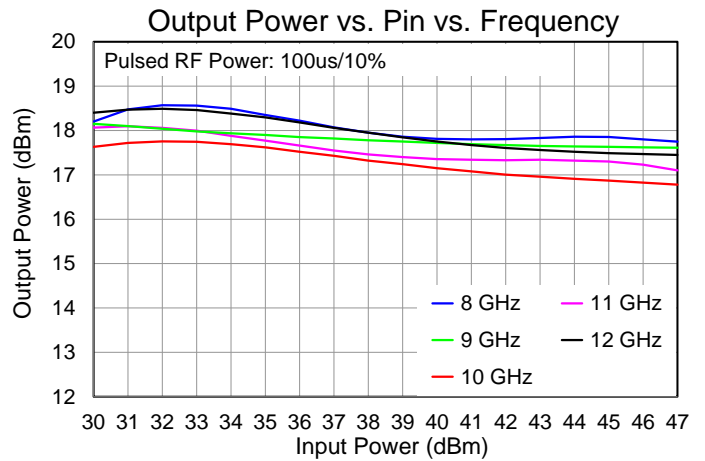
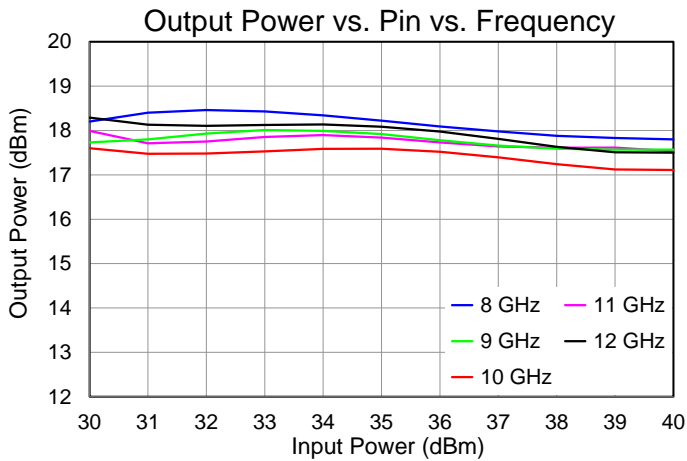
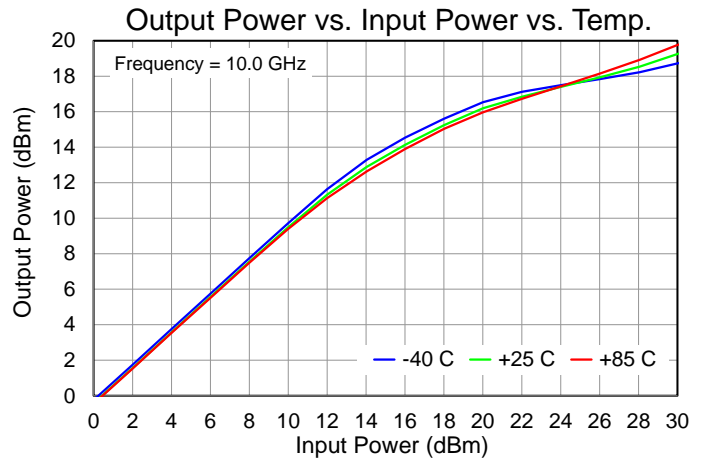
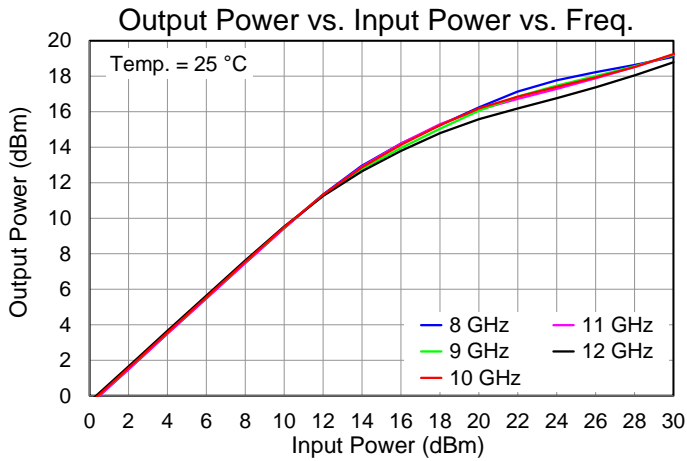

Application Circuit and Evaluation Board (EVB)

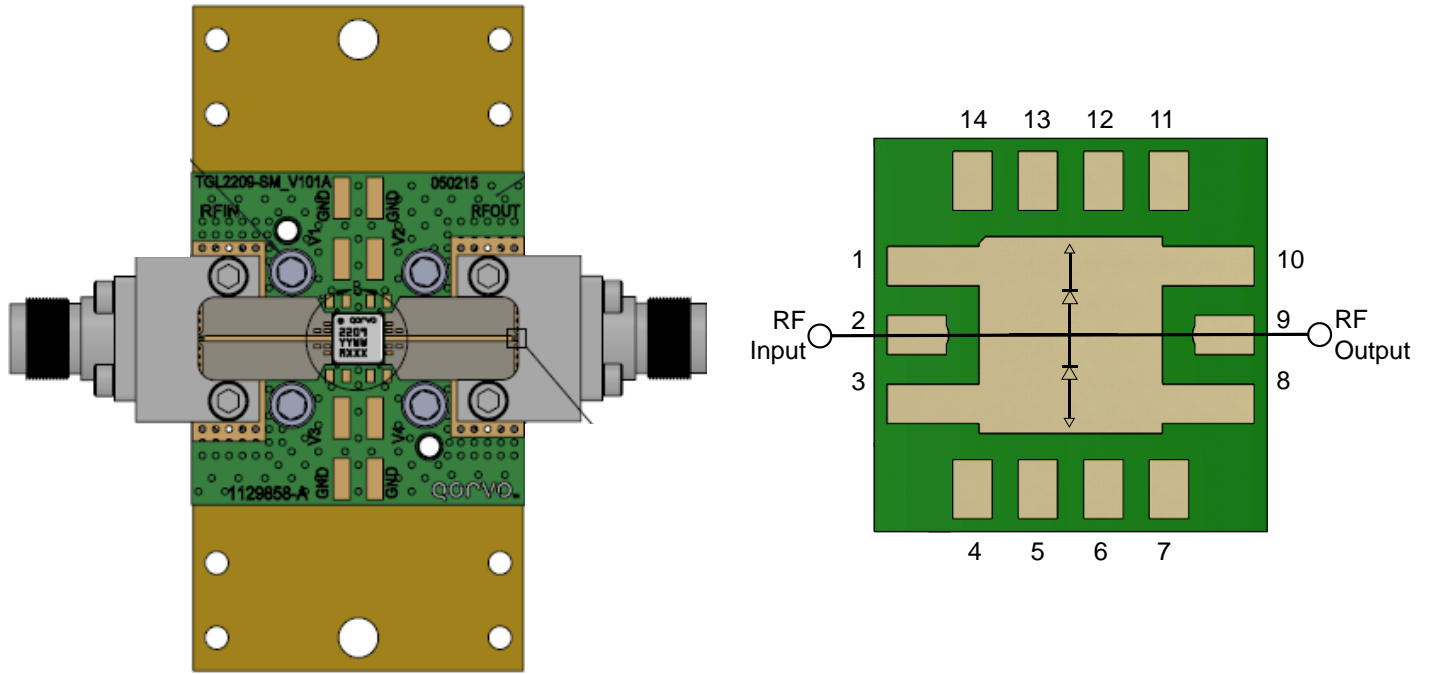

Notes:

1. See Evaluation Board PCB Information for material and stack up.

Bill of Material – EVB

Ref. Des.	Value	Description	Manuf.	Part Number
n/a	n/a	Printed Circuit Board	Qorvo	
U1	n/a	8 – 12 GHz 50 W VPIN Limiter	Qorvo	TGL2209-SM
J1, J2	n/a	2.92 mm End Launch Connector	Southwest Microwave	1092-01A-5

Pad Configuration and Description

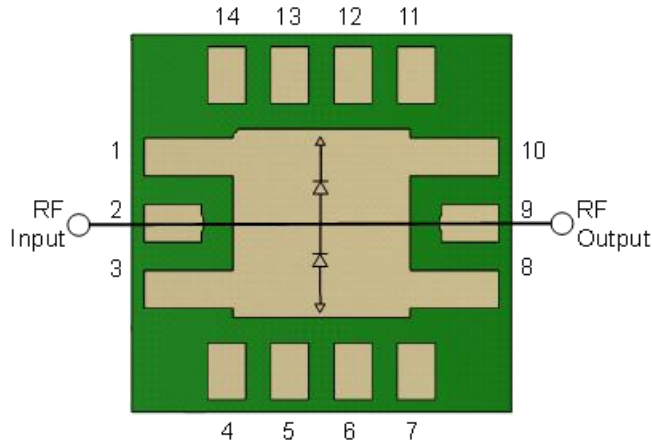

Top View

Pad No.	Label	Description
1, 3, 8, 10	GND	On PCB, multiple copper-filled vias should be employed under the center pad to minimize inductance and thermal resistance
2	RF Input	RF Input, matched to 50 Ohms, not DC blocked
4 – 7, 11 – 14	NC	No connection; may be grounded if desired
9	RF Output	RF Output, matched to 50 Ohms, not DC blocked

NOTE: The RF Input and RF Output ports are not interchangeable.

Evaluation Board PCB Information and Mounting Detail

EVB PC Board Layout

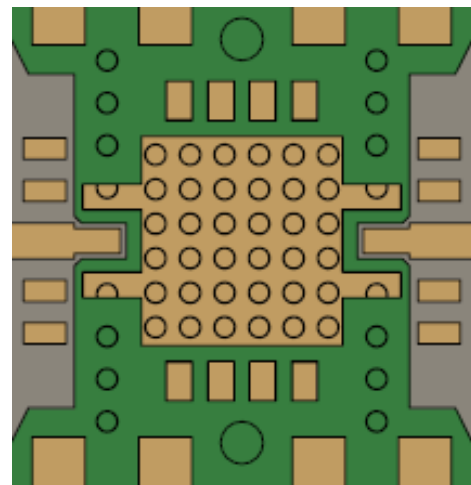
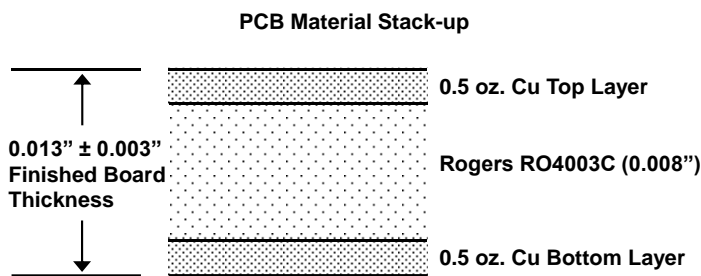

Package Marking and Dimensions

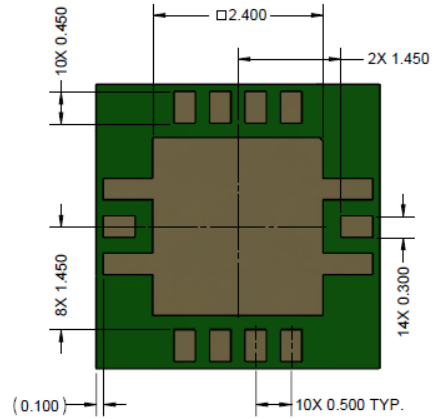
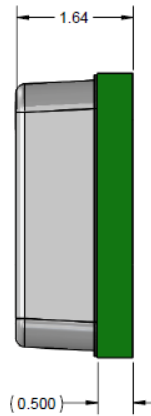
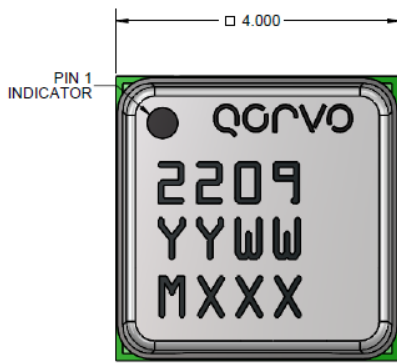

- NOTES:
1. PACKAGE BASE: LAMINATE
  2. PACKAGE LID: PLASTIC
  3. ALL METALIZED FEATURES ARE GOLD PLATED.
  4. THE PART IS EPOXY SEALED
  5. PART MARKING:  
 2209: PART NUMBER  
 YY: PART ASSY YEAR  
 WW: PART ASSY WEEK  
 MXXX: BATCH ID

- Notes:
1. All dimensions are in millimeters. Angles are in degrees.
  2. Contact plating: Ni-Pd-Au

Assembly Notes

- Compatible with lead-free soldering process with 260°C peak reflow temperature.
- This package is non-hermetic, and therefore cannot be subjected to aqueous washing. The use of no-clean solder to avoid washing after soldering is recommended
- Solder rework not recommended.
- Contact plating: Ni-Pd-Au

Recommended Soldering Profile

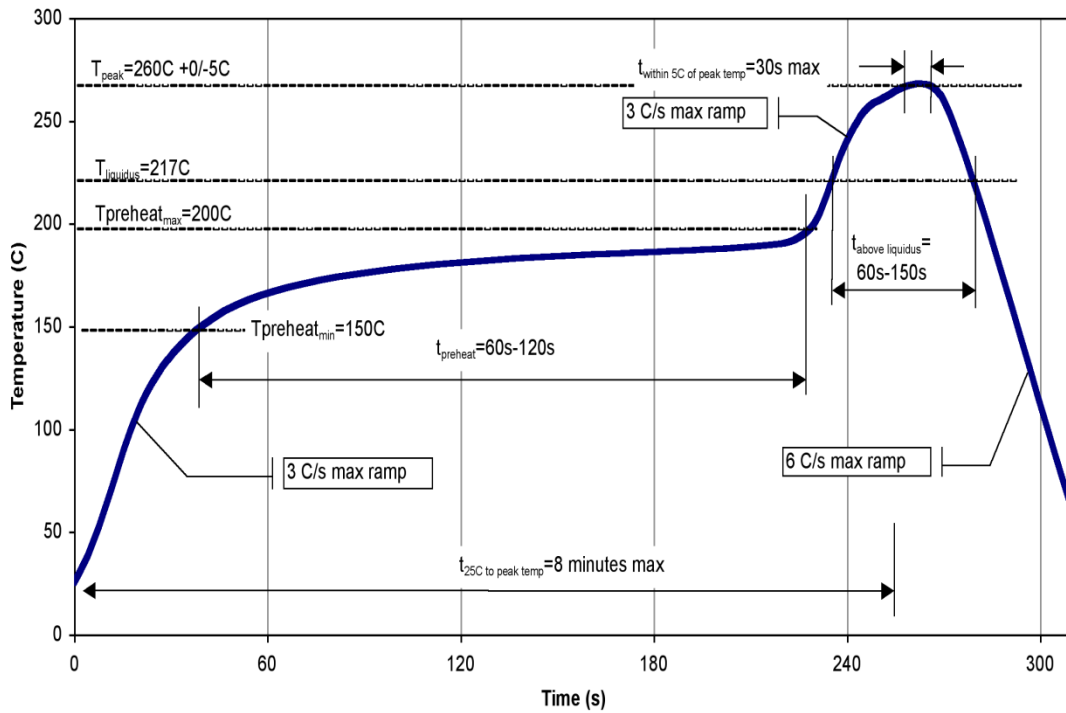



## Handling Precautions

Parameter	Rating	Standard
ESD – Human Body Model (HBM)	Class 1C	ESDA / JEDEC JS-001-2012
ESD – Charged Device Model (CDM)	Class C3	JEDEC JESD22-C101F
MSL – Moisture Sensitivity Level	Level 3	IPC/JEDEC J-STD-020



Caution!  
ESD-Sensitive Device

## RoHS Compliance

This part is compliant with 2011/65/EU RoHS directive (Restrictions on the Use of Certain Hazardous Substances in Electrical and Electronic Equipment) as amended by Directive 2015/863/EU.

This product also has the following attributes:

- Lead Free
- Halogen Free (Chlorine, Bromine)
- Antimony Free
- TBBP-A (C<sub>15</sub>H<sub>12</sub>Br<sub>4</sub>O<sub>2</sub>) Free
- PFOS Free



## Contact Information

For the latest specifications, additional product information, worldwide sales and distribution locations:

Web: [www.qorvo.com](http://www.qorvo.com)

Tel: 1-844-890-8163

Email: [customer.support@qorvo.com](mailto:customer.support@qorvo.com)

## Important Notice

The information contained herein is believed to be reliable; however, Qorvo makes no warranties regarding the information contained herein and assumes no responsibility or liability whatsoever for the use of the information contained herein. All information contained herein is subject to change without notice. Customers should obtain and verify the latest relevant information before placing orders for Qorvo products. The information contained herein or any use of such information does not grant, explicitly or implicitly, to any party any patent rights, licenses, or any other intellectual property rights, whether with regard to such information itself or anything described by such information. **THIS INFORMATION DOES NOT CONSTITUTE A WARRANTY WITH RESPECT TO THE PRODUCTS DESCRIBED HEREIN, AND QORVO HEREBY DISCLAIMS ANY AND ALL WARRANTIES WITH RESPECT TO SUCH PRODUCTS WHETHER EXPRESS OR IMPLIED BY LAW, COURSE OF DEALING, COURSE OF PERFORMANCE, USAGE OF TRADE OR OTHERWISE, INCLUDING THE IMPLIED WARRANTIES OF MERCHANTABILITY AND FITNESS FOR A PARTICULAR PURPOSE.**

Without limiting the generality of the foregoing, Qorvo products are not warranted or authorized for use as critical components in medical, life-saving, or life-sustaining applications, or other applications where a failure would reasonably be expected to cause severe personal injury or death.

Copyright 2020 © Qorvo, Inc. | Qorvo is a registered trademark of Qorvo, Inc.