

Product Description

Qorvo's QPA1014 is a high-power, S-band MMIC amplifier fabricated on Qorvo's 0.25um GaN on SiC production process (QGaN25). Covering 2.7 – 3.7 GHz, the QPA1014 provides 40 W of saturated output power with 24 dB large signal gain and 48% power-added efficiency.

The QPA1014 is packaged in a plastic overmold QFN with a pure Cu paddle offering easy handling with good thermal properties. As a result, the QPA1014 has bias flexibility allowing the user to vary the voltage to achieve optimum system performance while maintaining high reliability.

The QPA1014 is matched to 50 ohms with integrated DC blocking caps on both I/O ports. With the high performance, good thermal characteristics and ease of handling and system integration, the QPA1014 is ideal for use in both commercial and military radar systems.

Lead-free and RoHS compliant.

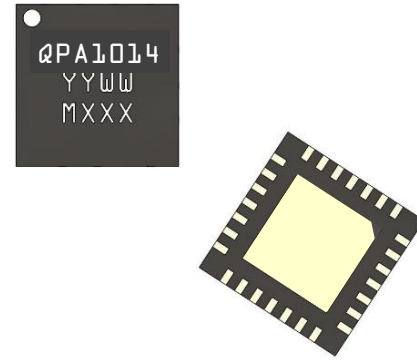

Product Features

- Frequency Range: 2.7 – 3.7 GHz
- Pout: 46 dBm ($P_{IN} = 22$ dBm)
- Large Signal Gain: 24 dB ($P_{IN} = 22$ dBm)
- PAE: 48 % ($P_{IN} = 22$ dBm)
- Bias: $V_D = 28$ V, $I_{DQ} = 450$ mA, $V_G = -2.7$ V (Typ)
- Supports Long Pulse Operation
- Package Dimensions: 6.0 x 6.0 x 0.85 mm

Performance is typical across frequency. Please reference electrical specification table and data plots for more details.

Functional Block Diagram

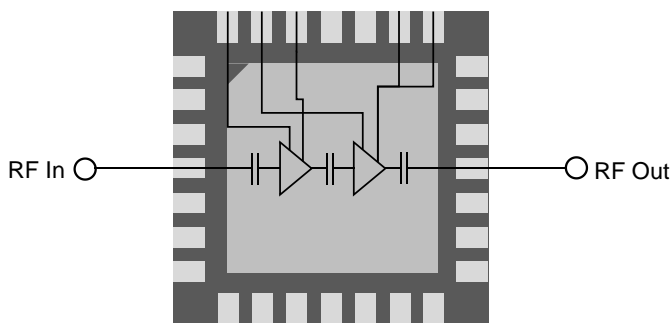

Applications

- Military Radar
- Commercial Radar

Ordering Information

Part	Description
QPA1014	2.7–3.7 GHz 30 W GaN Power Amplifier
QPA1014S2	Sample Box of 2
QPA1014PCB4B02	QPA1014 Eval Board

Electrical Specifications

Test conditions, unless otherwise noted: 25 °C, $V_D = 28$ V, $I_{DQ} = 450$ mA, Pulse Width = 100 us, Duty Cycle = 10%

Parameter		Min	Typ	Max	Units
Operational Frequency Range		2.7		3.7	GHz
Output Power ($P_{IN} = 22$ dBm)	Frequency = 2.7 GHz Frequency = 3.1 GHz Frequency = 3.7 GHz		45.9 46.2 45.5		dBm
Power Added Efficiency ($P_{IN} = 22$ dBm)	Frequency = 2.7 GHz Frequency = 3.1 GHz Frequency = 3.7 GHz		48.1 53.2 51.1		%
Small Signal Gain	Frequency = 2.7 GHz Frequency = 3.1 GHz Frequency = 3.7 GHz		31.8 30.3 29.3		dB
Input Return Loss	Frequency = 2.7 GHz Frequency = 3.1 GHz Frequency = 3.7 GHz		13.5 25.5 7.5		dB
Output Return Loss	Frequency = 2.7 GHz Frequency = 3.1 GHz Frequency = 3.7 GHz		10.0 22.0 10.0		dB
2 nd Harmonic ($P_{OUT} = 40$ dBm)	Frequency = 2.7 GHz Frequency = 3.1 GHz Frequency = 3.5 GHz		-17.5 -29.5 -37.0		dBc
3 rd Harmonic ($P_{OUT} = 40$ dBm)	Frequency = 2.7 GHz Frequency = 3.1 GHz Frequency = 3.5 GHz		-54.5 -62.0 -64.0		dBc
Output Power Temperature Coefficient ($P_{IN} = 22$ dBm)			-0.013		dBm/°C
Small Signal Gain Temperature Coefficient			-0.049		dB/°C

Recommended Operating Conditions

Parameter	Value
Drain Voltage	28 V
Drain Current (quiescent, I_{DQ})	450 mA
Drain Current (under drive, I_D)	3.7 A
Gate Voltage	-2.7 V
Operating Temperature Range	-40 to 85 °C

Electrical specifications are measured at specified test conditions. Specifications are not guaranteed over all recommended operating conditions.

Performance Plots – Large Signal (Pulsed)

Test conditions unless otherwise noted: Temp. = 25 °C, $V_D = 28$ V, $I_{DQ} = 450$ mA, PW = 100 us, Duty Cycle = 10%

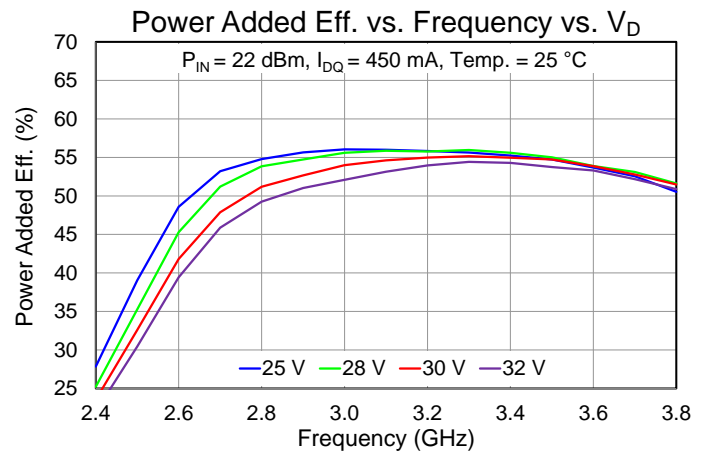
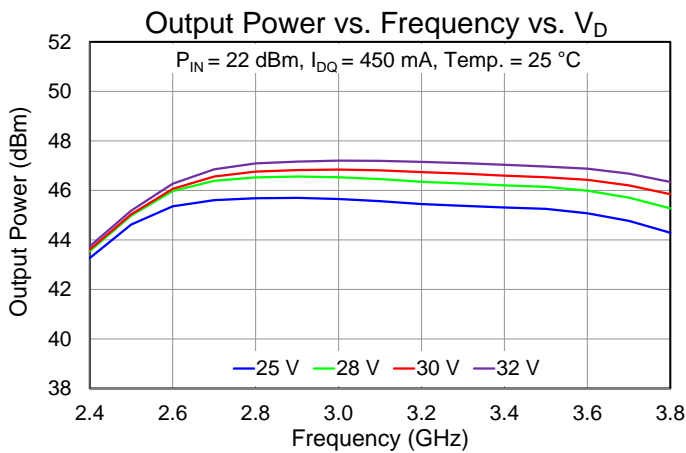
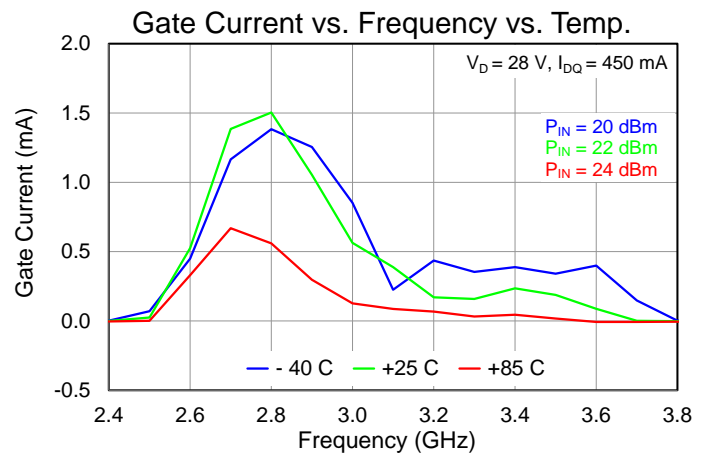
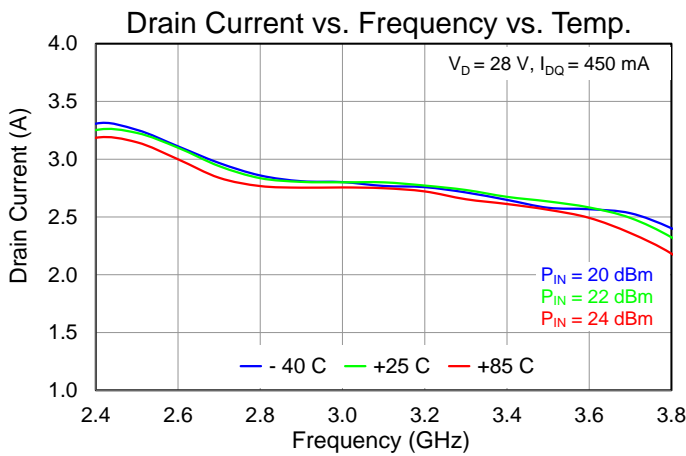
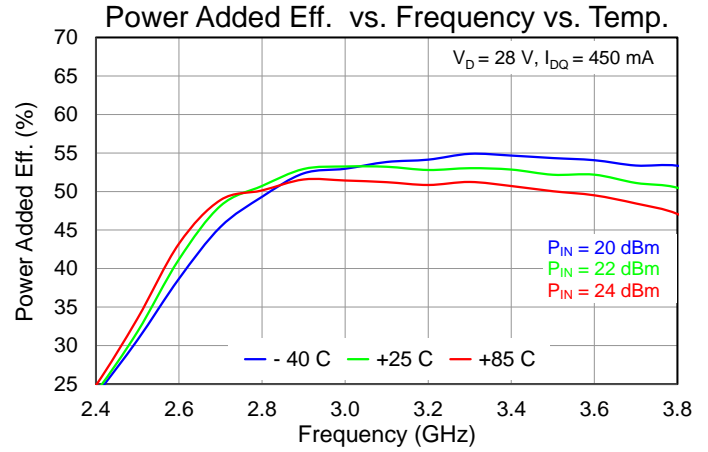
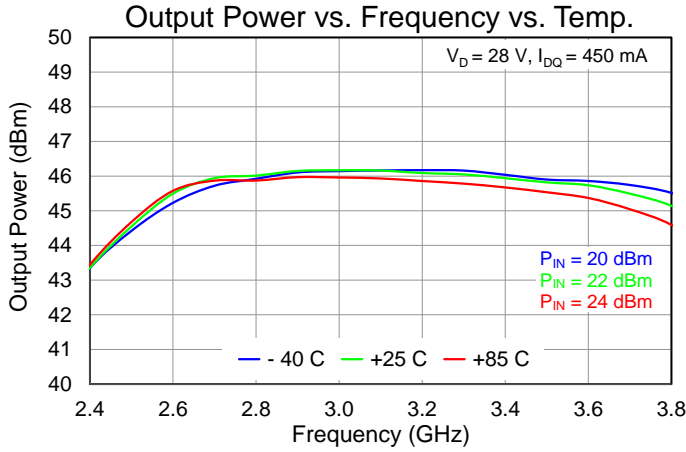

Performance Plots – Large Signal (Pulsed)

Test conditions unless otherwise noted: Temp. = 25 °C, $V_D = 28$ V, $I_{DQ} = 450$ mA, PW = 100 us, Duty Cycle = 10%

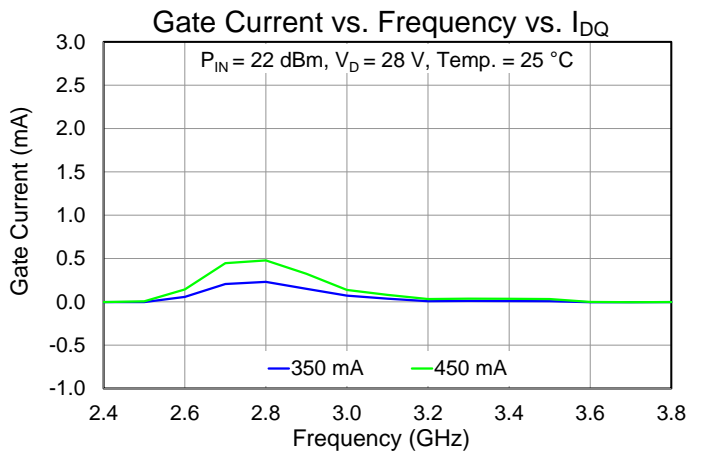
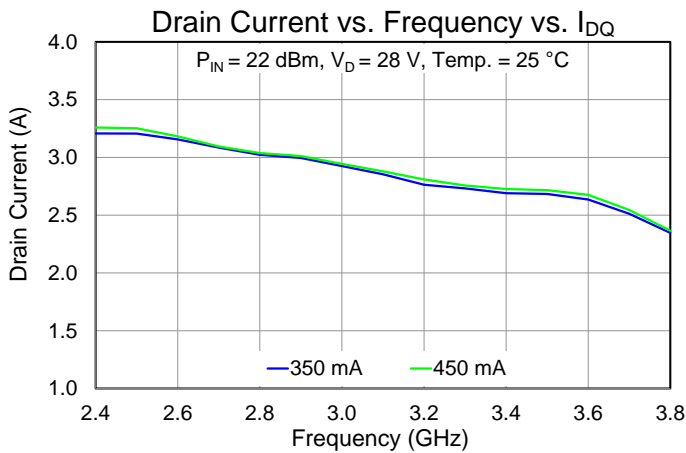
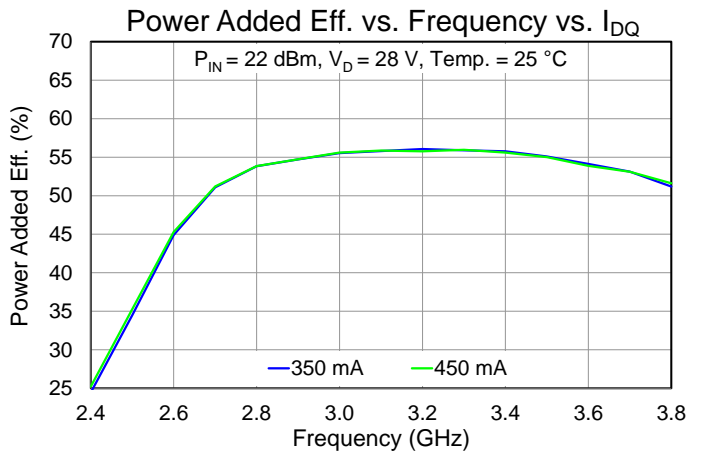
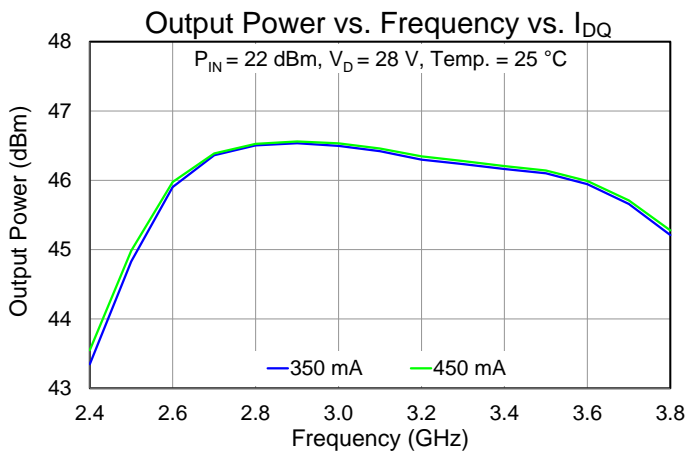
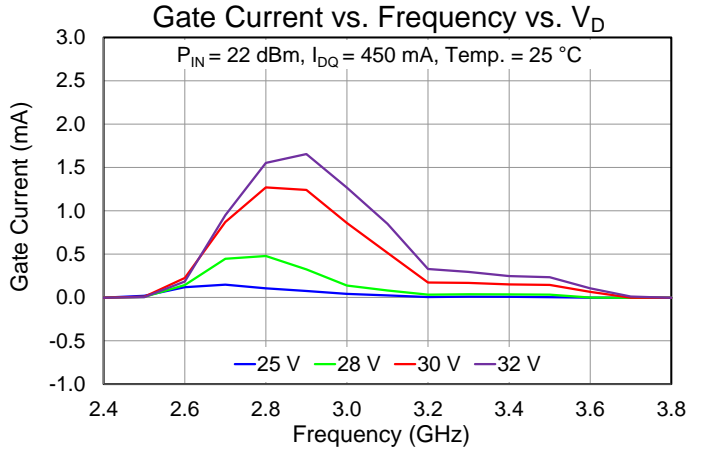
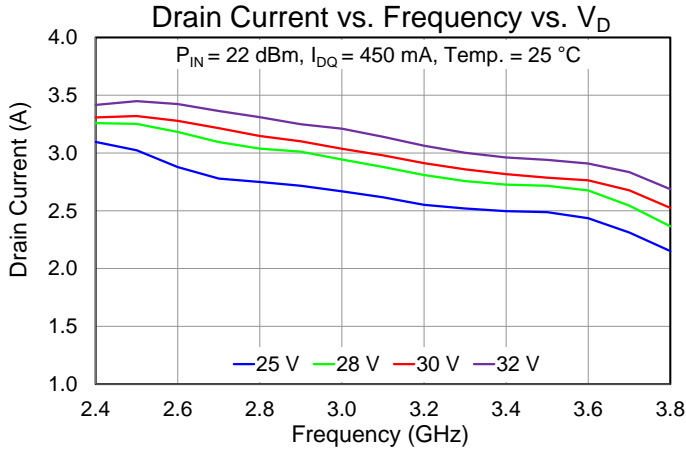

Performance Plots – Large Signal (Pulsed)

Test conditions unless otherwise noted: Temp. = 25 °C, $V_D = 28$ V, $I_{DQ} = 450$ mA, PW = 100 us, Duty Cycle = 10%

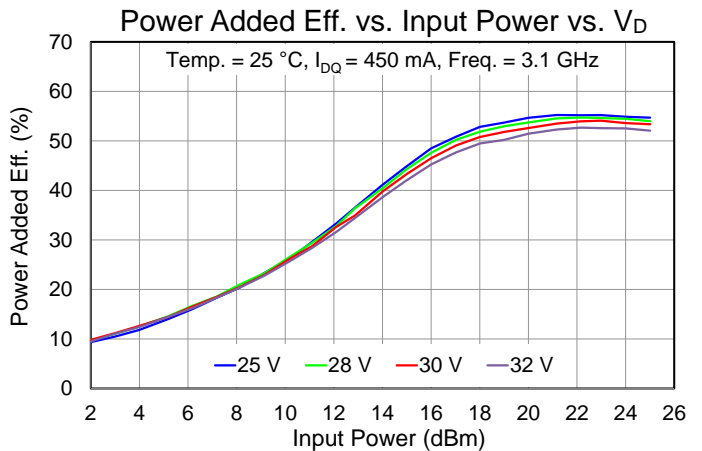
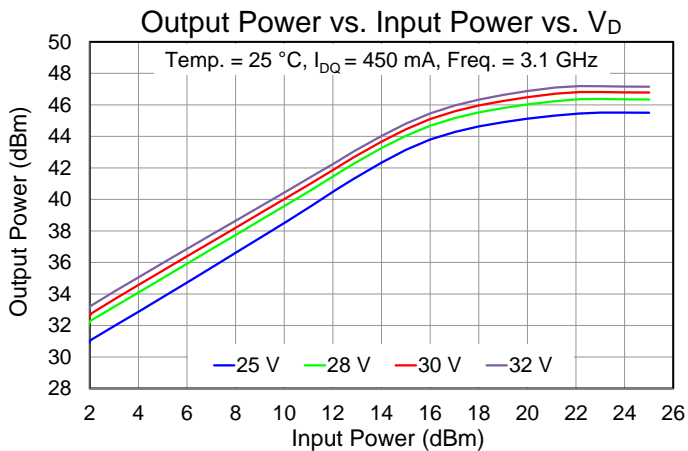
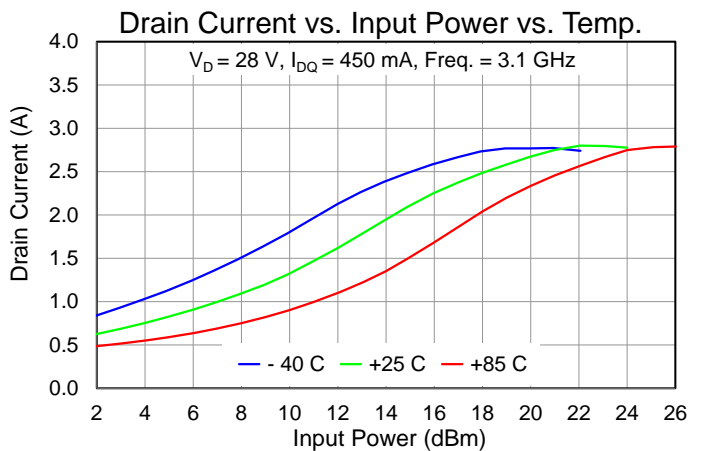
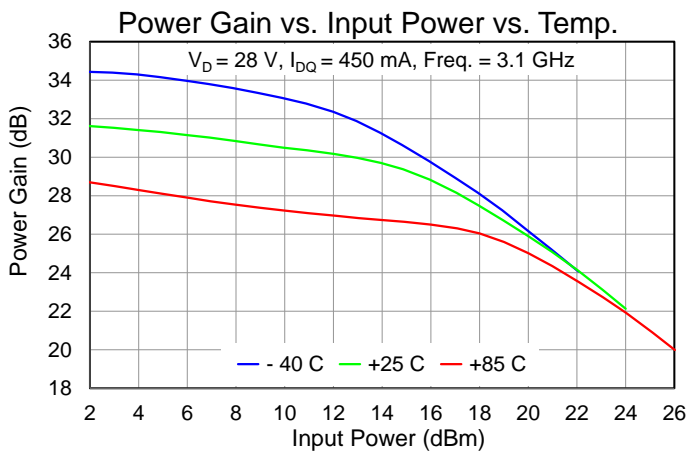
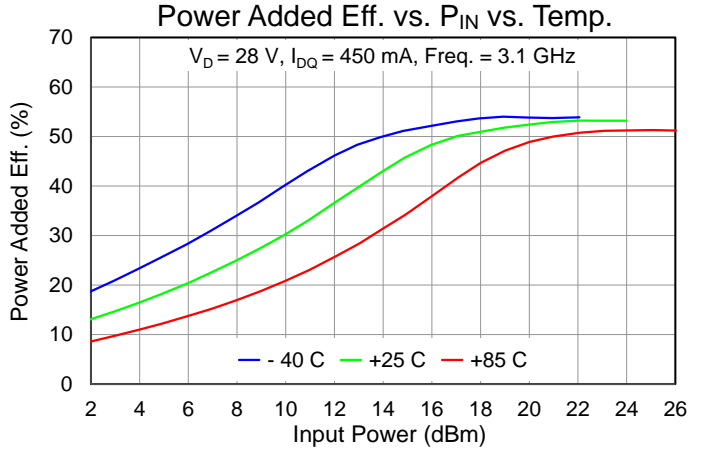
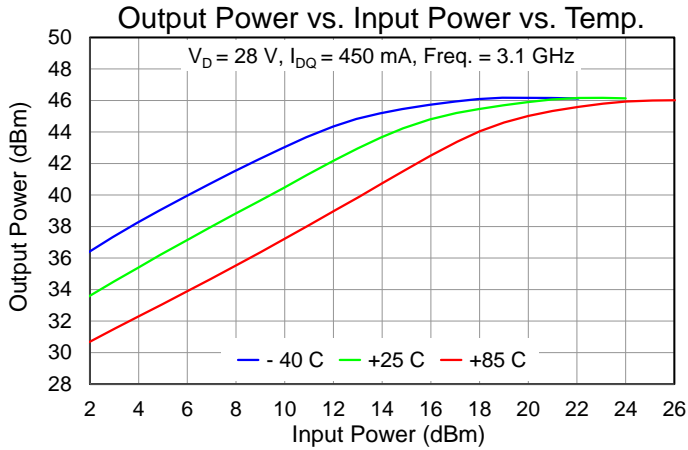

Performance Plots – Large Signal (Pulsed)

Test conditions unless otherwise noted: Temp. = 25 °C, $V_D = 28$ V, $I_{DQ} = 450$ mA, PW = 100 us, Duty Cycle = 10%

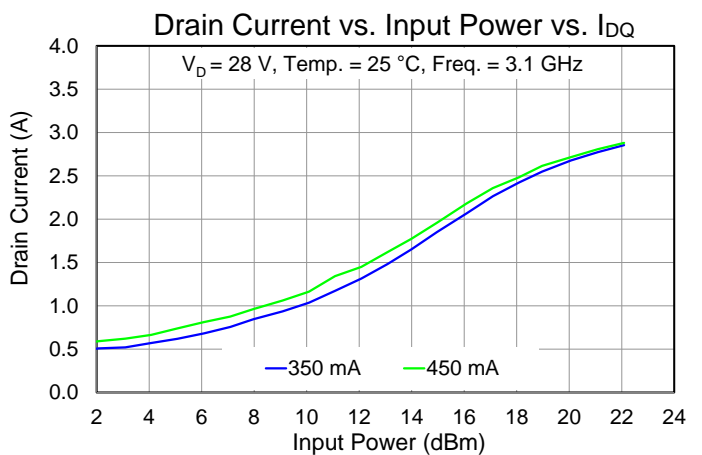
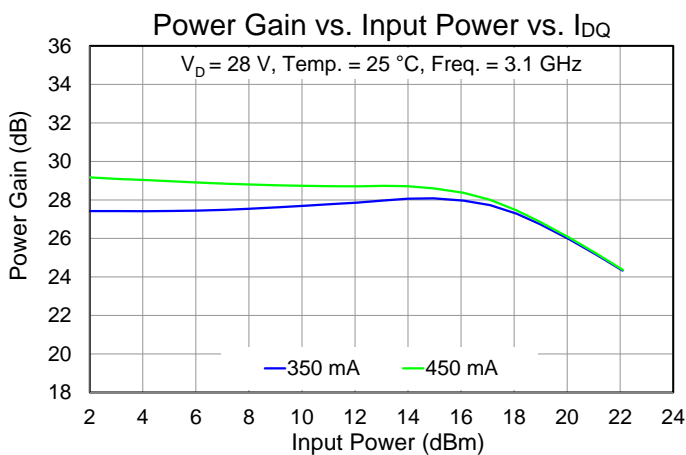
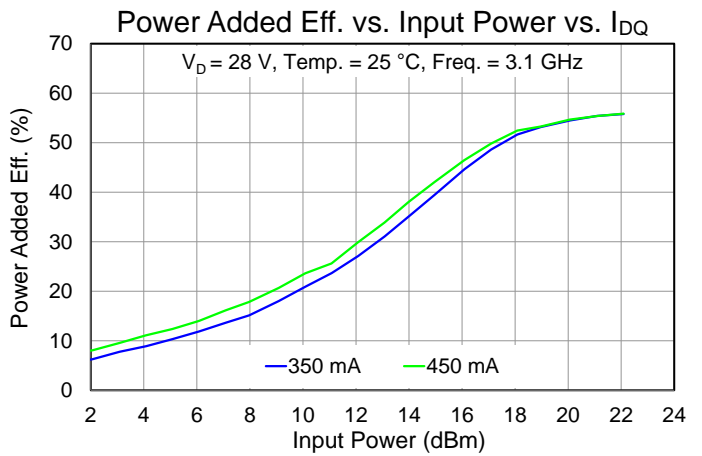
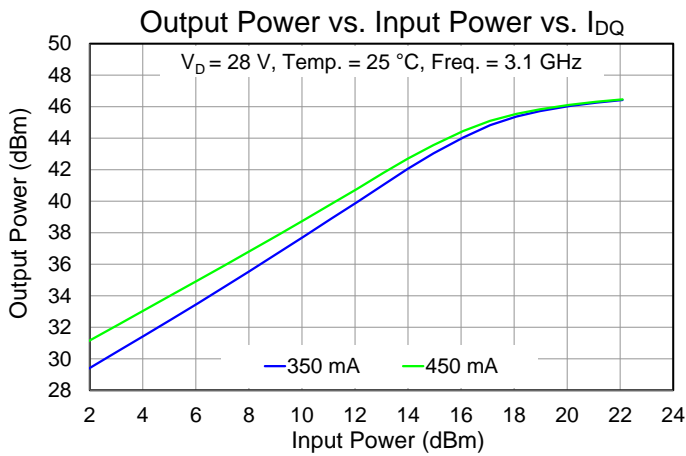
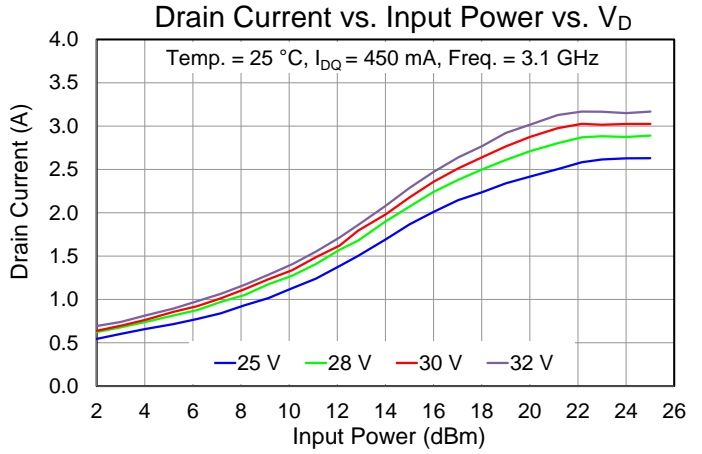
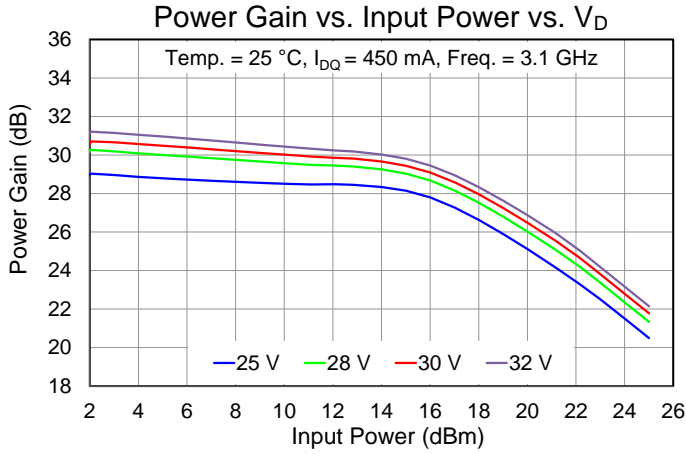

Performance Plots – Large Signal (Long Pulse Comparison)

Test conditions unless otherwise noted: Temp. = 25 °C, $V_D = 28$ V, $I_{DQ} = 450$ mA

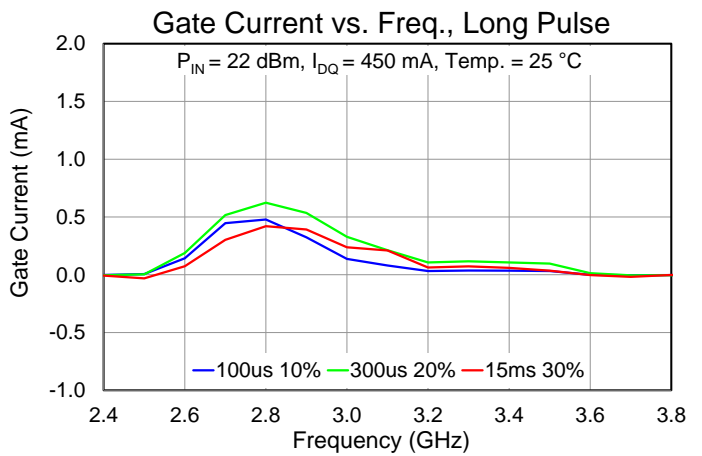
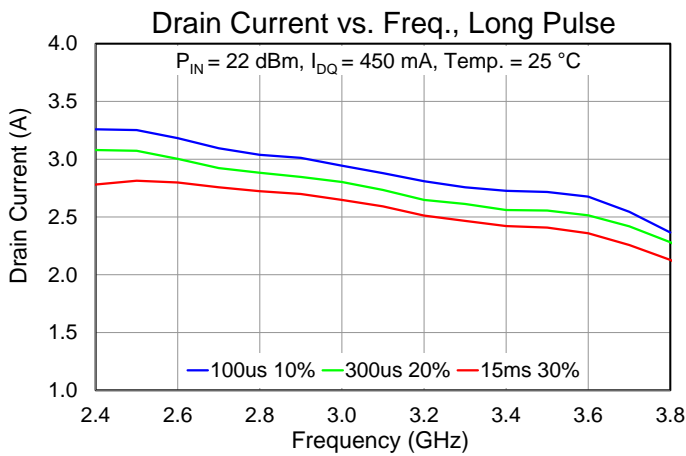
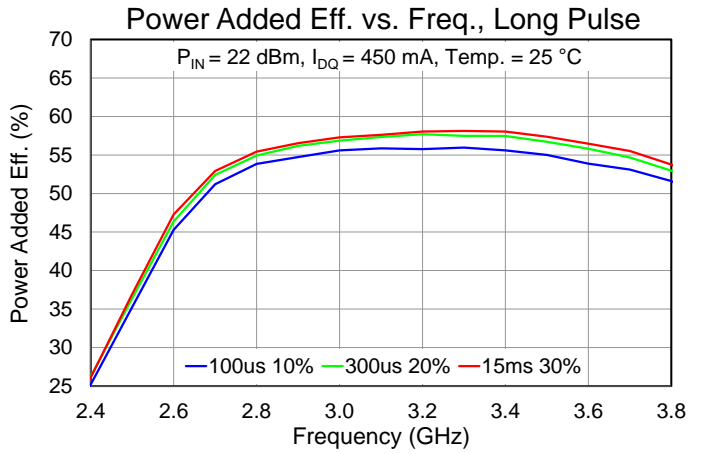
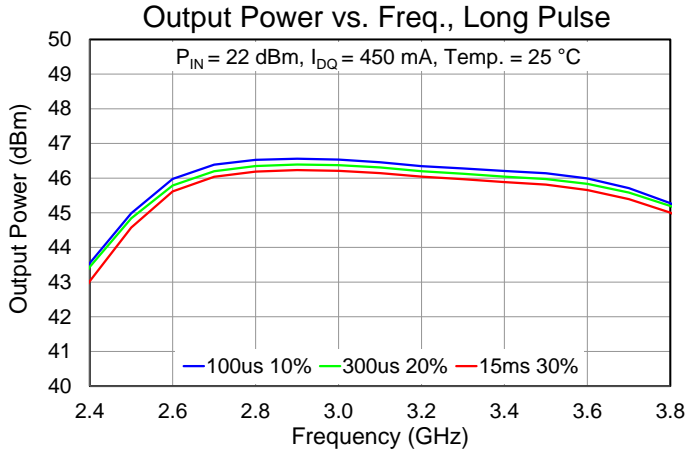

Performance Plots – Harmonics

Test conditions unless otherwise noted: Temp. = 25 °C, $V_D = 28$ V, $I_{DQ} = 450$ mA, PW = 100 us, Duty Cycle = 10%

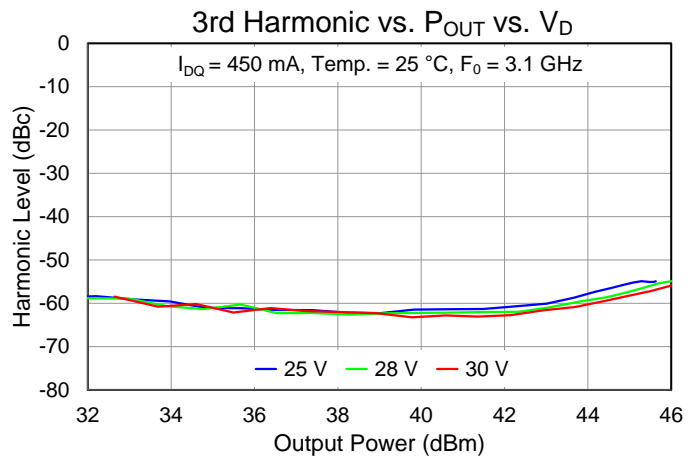
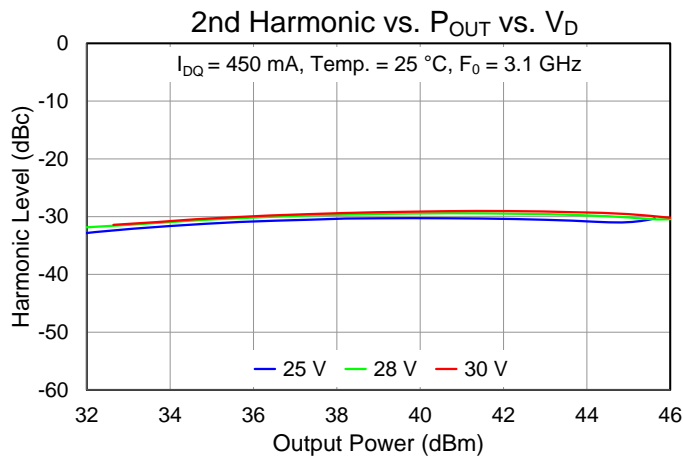
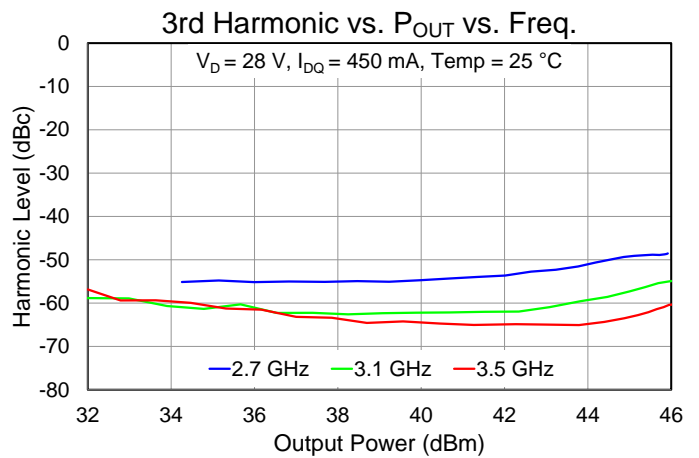
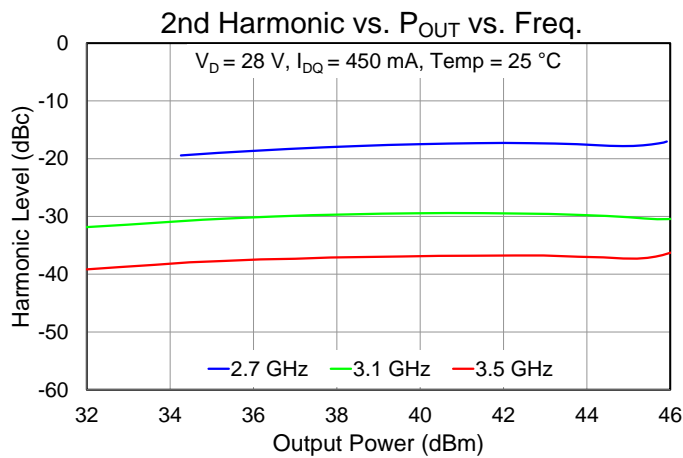
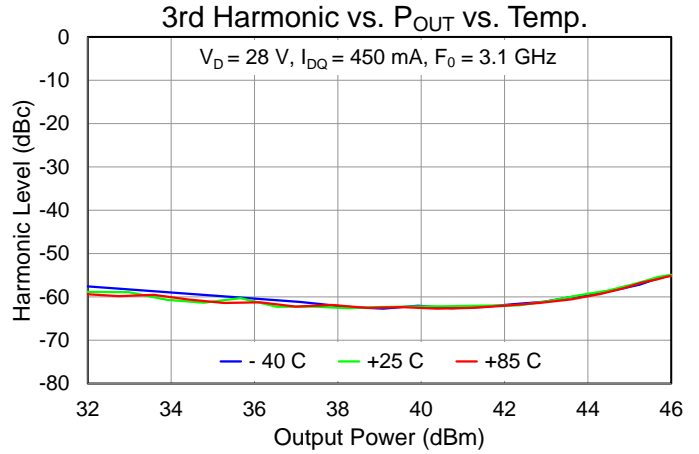
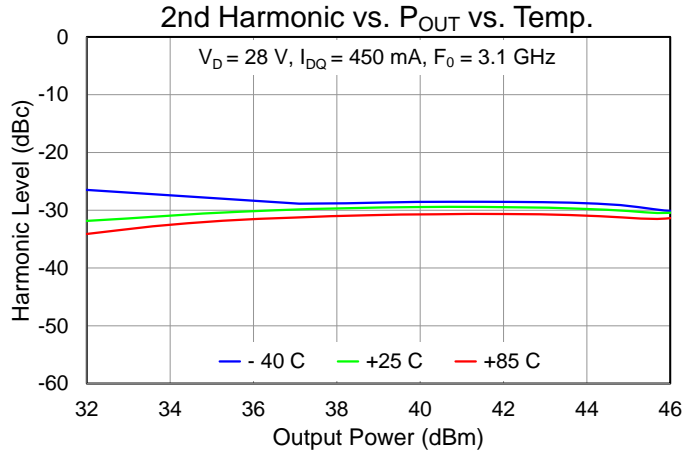

Performance Plots – Small Signal

Test conditions unless otherwise noted: Temp. = 25 °C, $V_D = 28$ V, $I_{DQ} = 450$ mA

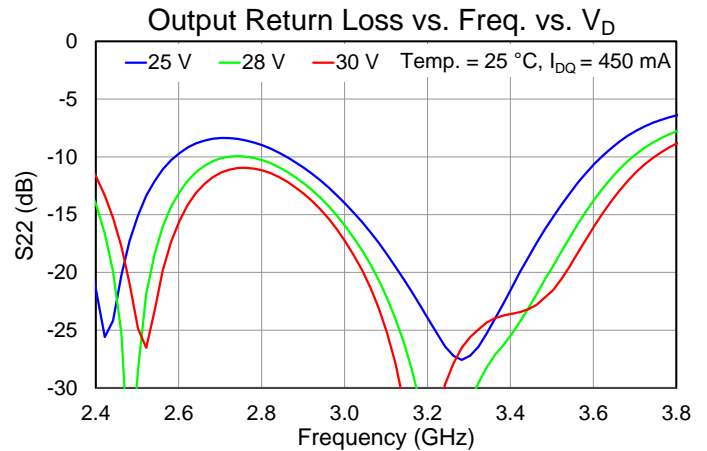
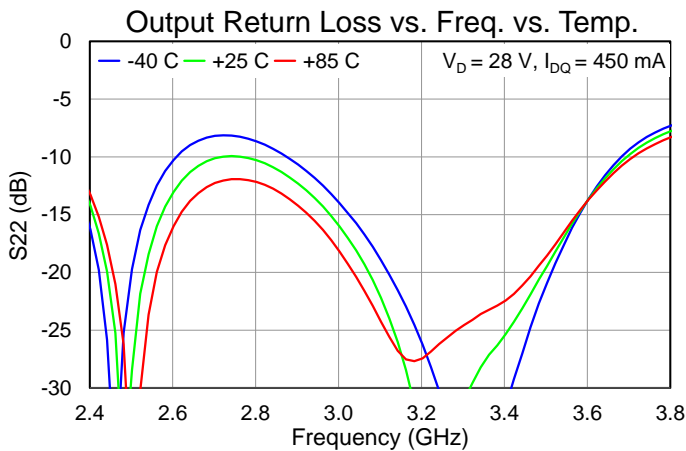
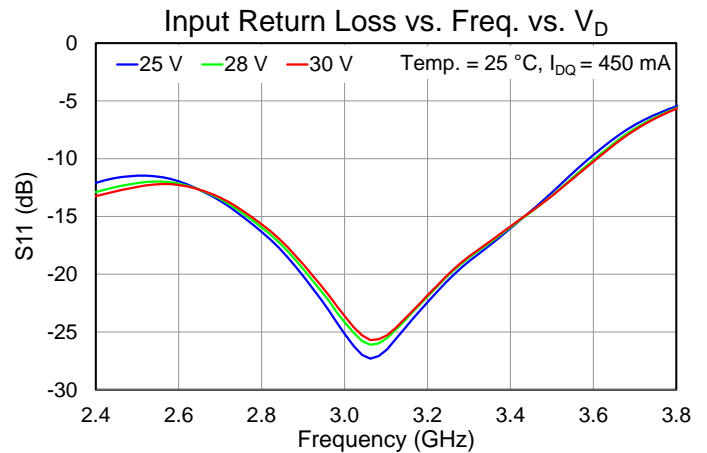
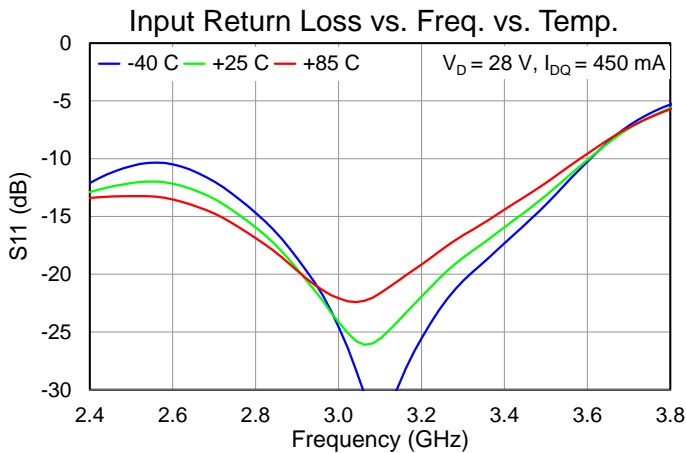
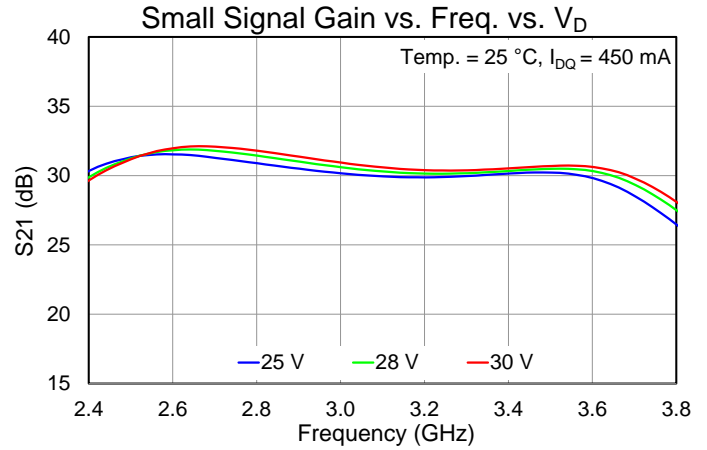
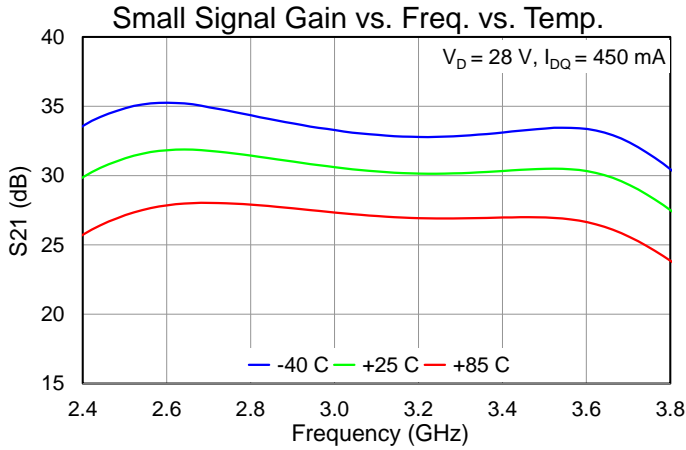

Performance Plots – Small Signal

Test conditions unless otherwise noted: Temp. = 25 °C, $V_D = 28$ V, $I_{DQ} = 450$ mA

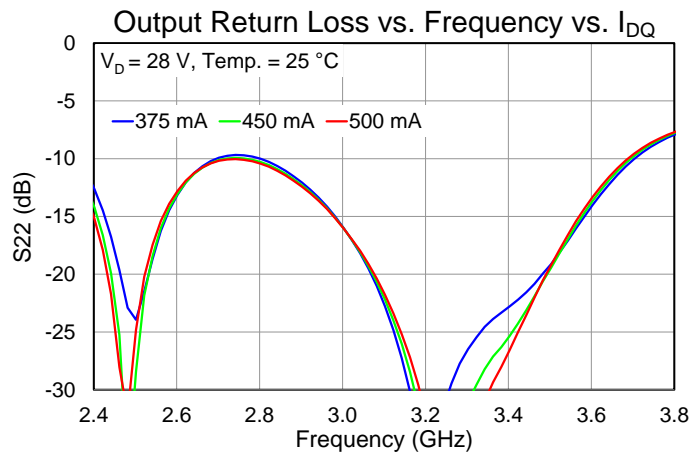
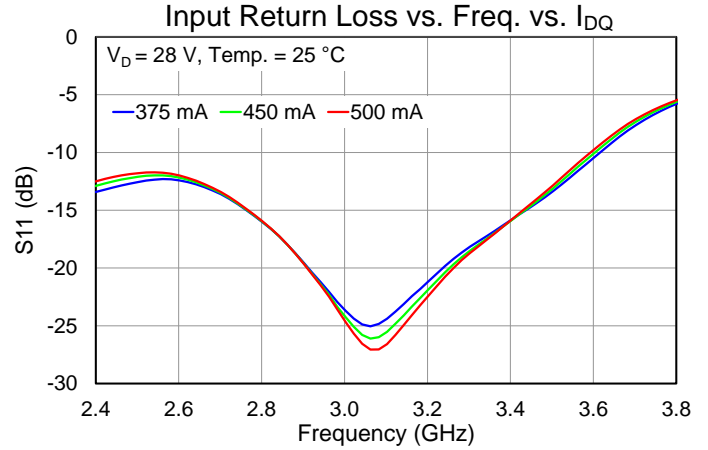
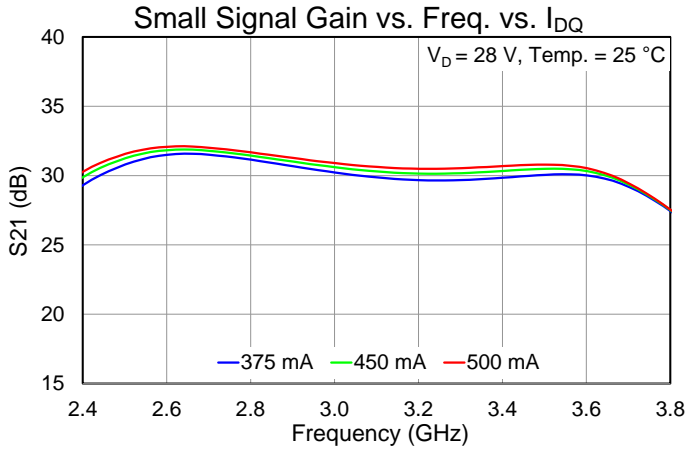

Thermal and Reliability Information

Parameter	Test Conditions	Value	Units
Thermal Resistance (θ_{JC}) ⁽¹⁾	$T_{base} = 85^{\circ}C$	1.43	$^{\circ}C/W$
Channel Temperature (T_{CH}) (Quiescent)	$V_D = 28 V, I_{DQ} = 450 mA$ $P_{DISS} = 12.6 W$	103	$^{\circ}C$
Thermal Resistance (θ_{JC}) ⁽¹⁾	$T_{base} = 85^{\circ}C, V_D = 28 V, I_{DQ} = 450 mA, Freq = 2.7 GHz,$	0.72	$^{\circ}C/W$
Channel Temperature (T_{CH}) (Under RF drive)	$I_{D_Drive} = 2.984 A, P_{IN} = 25 dBm, P_{OUT} = 46.1 dBm,$ $P_{DISS} = 40.5 W, PW = 100 \mu s, DC = 10\%$	114	$^{\circ}C$

Notes:

1. Thermal resistance measured to back of package.
2. Refer to the following document: [GaN Device Channel Temperature, Thermal Resistance, and Reliability Estimates](#)

Power Dissipation

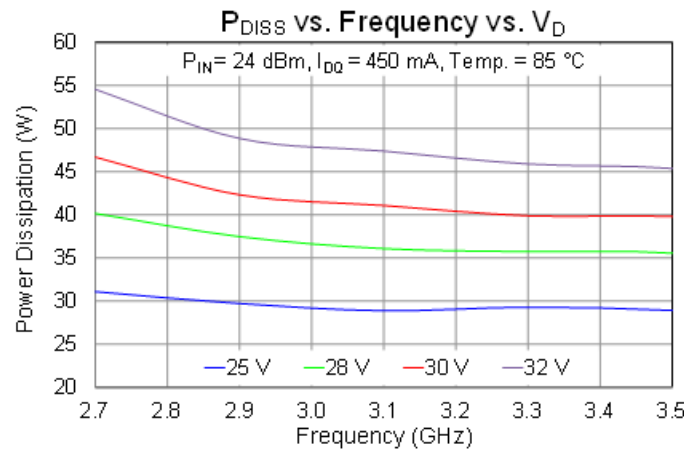

Applications Circuit

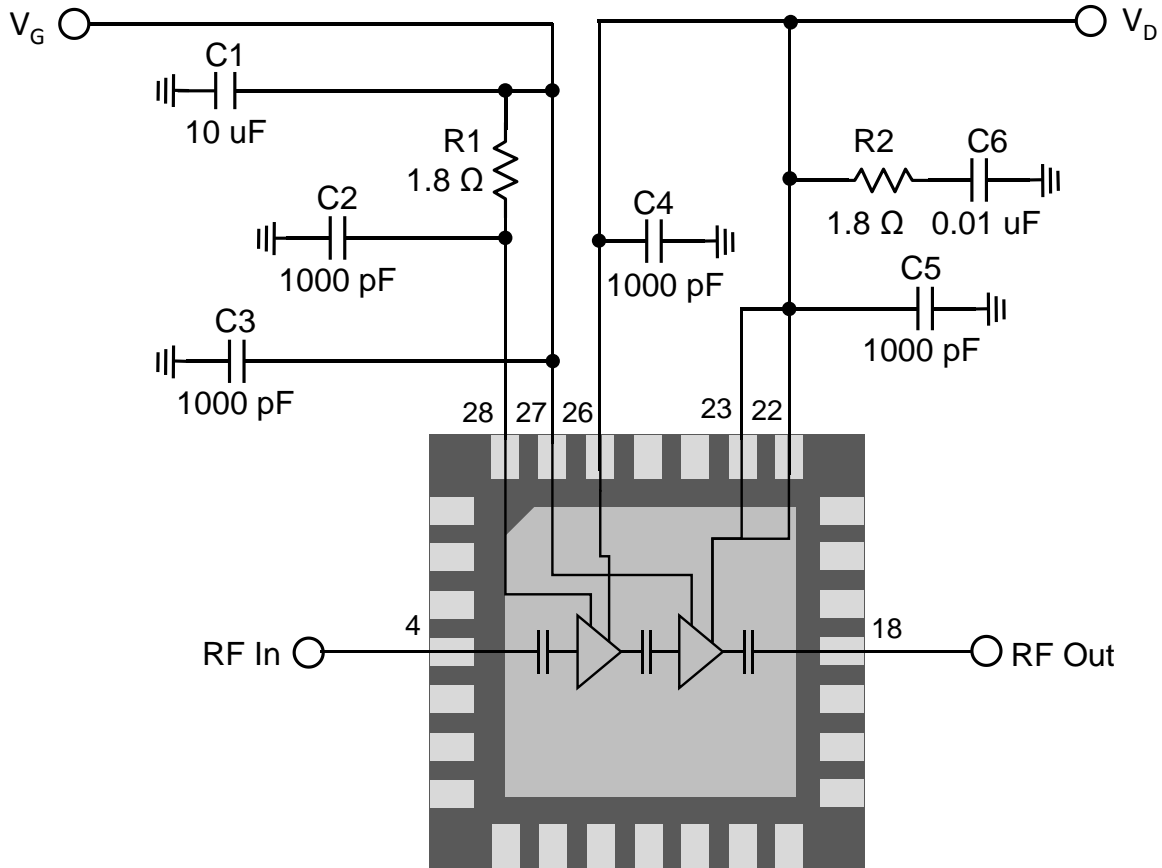

Bias Up Procedure

1. Set I_D limit to 4500mA, I_G limit to 40mA
2. Set V_G to -6.0 V
3. Set V_D +28 V
4. Adjust V_G more positive until $I_{DQ} = 450mA$ ($V_G \sim -2.7$ V Typical)
5. Apply RF signal

Bias Down Procedure

1. Turn off RF supply
2. Reduce V_G to -6.0V. Ensure $I_{DQ} \sim 0mA$
3. Set V_D to 0V
4. Turn off V_D supply
5. Turn off V_G supply

Evaluation Board and Mounting Detail

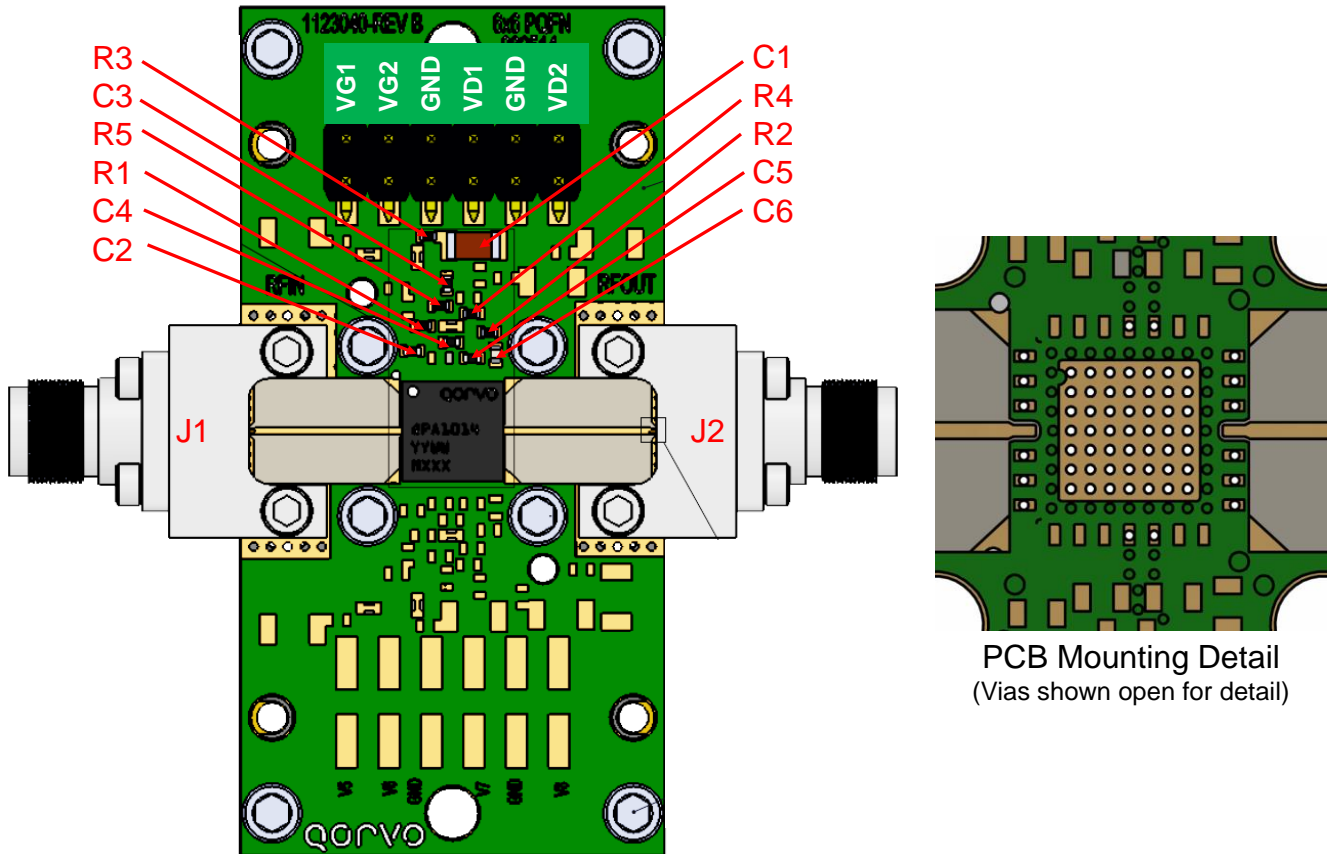

Notes:

1. RF Layer is 0.008" thick Rogers Corp. RO40003C ($\epsilon_r = 3.55$). Metal layers are 0.5 oz. copper.
2. Via holes under the DUT should be copper-filled to improve thermal and electrical performance.

Bill of Materials

Ref. Des.	Component	Value	Manuf.	Part Number
C1	Surface Mount Cap.	CAP, 1206, 10uF, 20%, 50V, 20%, X5R	Various	
C2 – C5	Surface Mount Cap.	CAP, 0402, 1000pF, 10%, 100V, X7R	Various	
C6	Surface Mount Cap.	CAP, 0402, 0.01uF, $\pm 10\%$, 50V, X7R	Various	
R1, R2	Surface Mount Res.	RES, 1.8 OHM, $\pm 5\%$, 1/10 W, 0402	Various	
R3 – R5 ¹	Surface Mount Res.	RES, 0 OHM, $\pm 5\%$, 0402	Various	
J1, J2	RF Connector	2.92 mm End Launch	SW Microwave	1092–01A–5

Note:

1. Replace R3–R5 with a metal trace, as they are not needed for operation. Thus, they are not shown in the schematic.

Mechanical Information

NOTES: UNLESS OTHERWISE SPECIFIED;

1. PART IS MOLD ENCAPSULATED.
2. PACKAGE EXPOSED METALLIZATION IS GOLD PLATED.

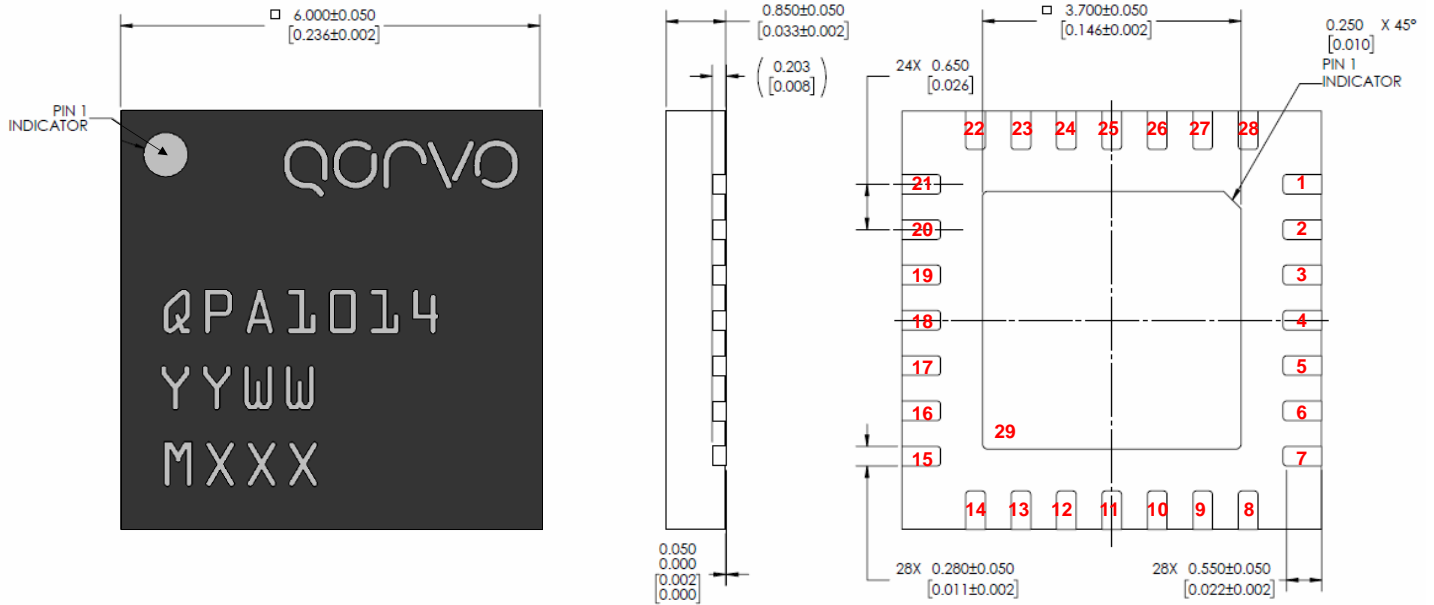

Pin Description

Pin Number	Symbol	Description
1-3, 5-17, 19-21, 24-25	NC	No internal connection. Recommend grounding at the PCB level.
4	RF Input	50 Ohm RF input. Pad is DC blocked.
18	RF Output	50 Ohm RF output. Pad is DC blocked.
22, 23	V_{D2}	2 nd Stage Drain Voltage; bias network is required (V_{D1} and V_{D2} can be tied together in application)
26	V_{D1}	1 st Stage Drain Voltage; bias network is required (V_{D1} and V_{D2} can be tied together in application)
27	V_{G2}	2 nd Stage Gate Voltage; bias network is required (V_{G1} and V_{G2} can be tied together in application)
28	V_{G1}	1 st Stage Gate Voltage; bias network is required (V_{G1} and V_{G2} can be tied together in application)
29	GND	Ground connection (center pad).

Absolute Maximum Ratings

Parameter	Value / Range
Drain Voltage (V_D)	40 V
Drain Current (I_{D1}/I_{D2})	0.39 / 3.5 A
Gate Voltage Range	-8 to 0 V
Gate Current (I_G)	See I_{G_Max} plot
Dissipated Power (P_{DISS}) ¹	44.25 W
Input Power (50 Ω , 85 °C) ²	28 dBm
Input Power (3:1 VSWR, 85 °C) ²	28 dBm
Mounting Temperature (30 seconds)	260 °C
Storage Temperature	-55 to 150 °C

Note:

¹ $T_{BASE} = 85\text{ °C}$, $T_{CH} = 225\text{ °C}$

² $V_D = 28\text{ V}$, $I_{DQ} = 450\text{ mA}$

Operation of this device outside the parameter ranges given above may cause permanent damage. These are stress ratings only, and functional operation of the device at these conditions is not implied.

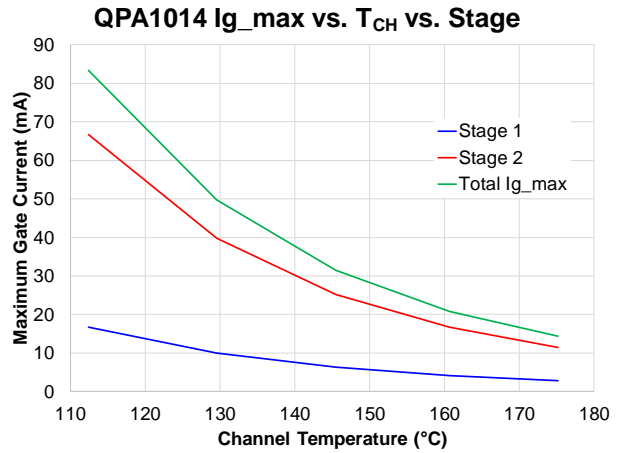

Recommended Soldering Temperature Profile

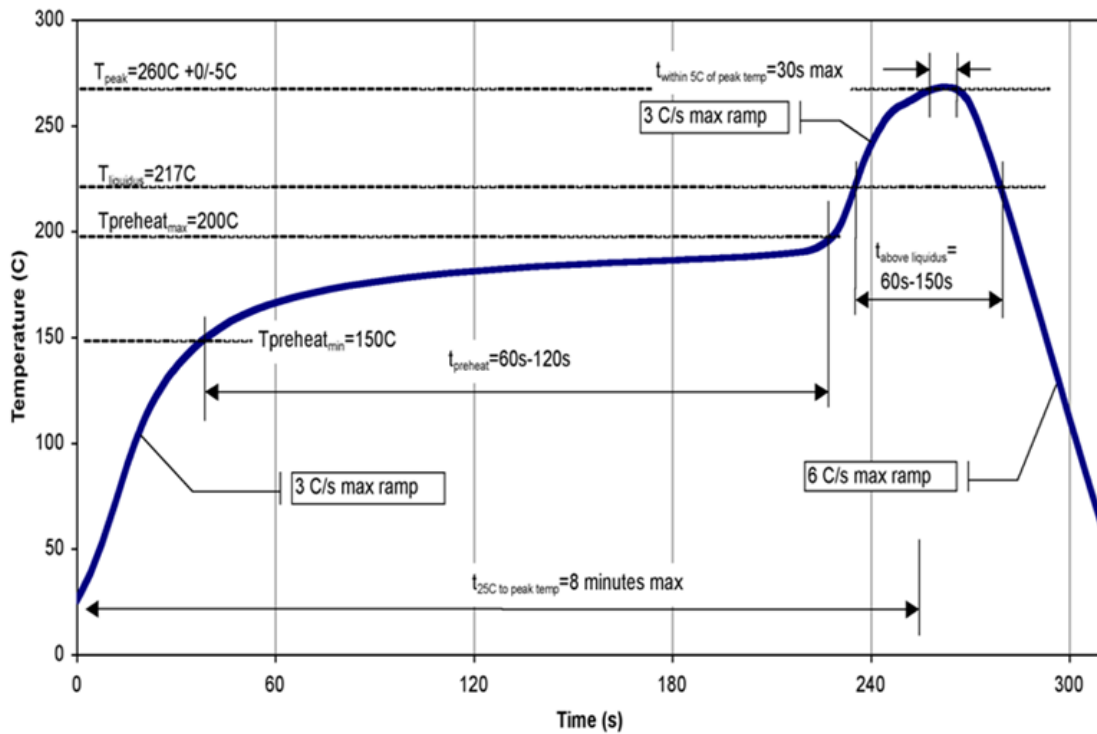

Handling Precautions

Parameter	Rating	Standard
ESD – Human Body Model (HBM)	Class 0B ($\leq 150V$)	ANSI/ESD/JEDEC JS-001
ESD – Charge Device Model (CDM)	Class C3	ANSI/ESD/JEDEC JS-002
MSL – Moisture Sensitivity Level	3	IPC/JEDEC J-STD-020



Caution!
ESD-Sensitive Device

Solderability

Compatible with the latest version of J-STD-020 Lead free solder, 260 °C.

RoHS Compliance

This product is compliant with the 2011/65/EU RoHS directive (Restrictions on the Use of Certain Hazardous Substances in Electrical and Electronic Equipment), as amended by Directive 2015/863/EU. This product also has the following attributes:

- Lead Free
- Halogen Free (Chlorine, Bromine)
- Antimony Free
- TBBP-A (C₁₅H₁₂Br₄O₂) Free
- PFOS Free
- SVHC Free
- Qorvo Green

Contact Information

For the latest specifications, additional product information, worldwide sales and distribution locations:

Tel: 1-844-890-8163

Web: www.qorvo.com

Email: customer.support@qorvo.com

Important Notice

The information contained herein is believed to be reliable; however, Qorvo makes no warranties regarding the information contained herein and assumes no responsibility or liability whatsoever for the use of the information contained herein. All information contained herein is subject to change without notice. Customers should obtain and verify the latest relevant information before placing orders for Qorvo products. The information contained herein or any use of such information does not grant, explicitly or implicitly, to any party any patent rights, licenses, or any other intellectual property rights, whether with regard to such information itself or anything described by such information. **THIS INFORMATION DOES NOT CONSTITUTE A WARRANTY WITH RESPECT TO THE PRODUCTS DESCRIBED HEREIN, AND QORVO HEREBY DISCLAIMS ANY AND ALL WARRANTIES WITH RESPECT TO SUCH PRODUCTS WHETHER EXPRESS OR IMPLIED BY LAW, COURSE OF DEALING, COURSE OF PERFORMANCE, USAGE OF TRADE OR OTHERWISE, INCLUDING THE IMPLIED WARRANTIES OF MERCHANTABILITY AND FITNESS FOR A PARTICULAR PURPOSE.**

Without limiting the generality of the foregoing, Qorvo products are not warranted or authorized for use as critical components in medical, life-saving, or life-sustaining applications, or other applications where a failure would reasonably be expected to cause severe personal injury or death.

Copyright 2018 © Qorvo, Inc. | Qorvo is a registered trademark of Qorvo, Inc.