

Product Overview

The CMD298C4 is a highly efficient GaAs MMIC low noise amplifier housed in a leadless 4x4 mm surface mount package. The CMD298C4 is ideally suited for EW and communications systems where small size and low power consumption are needed. The device is optimized for 21 GHz and delivers greater than 27 dB of gain with a corresponding noise figure of 1.4 dB and output 1 dB compression point of +8 dBm. The CMD298C4 is a 50 ohm matched design which eliminates the need for external DC blocks and RF port matching.

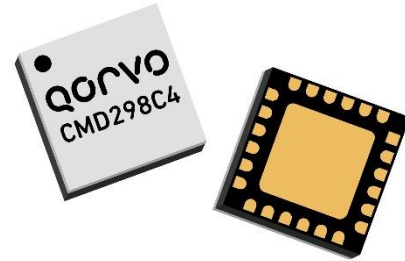

Functional Block Diagram

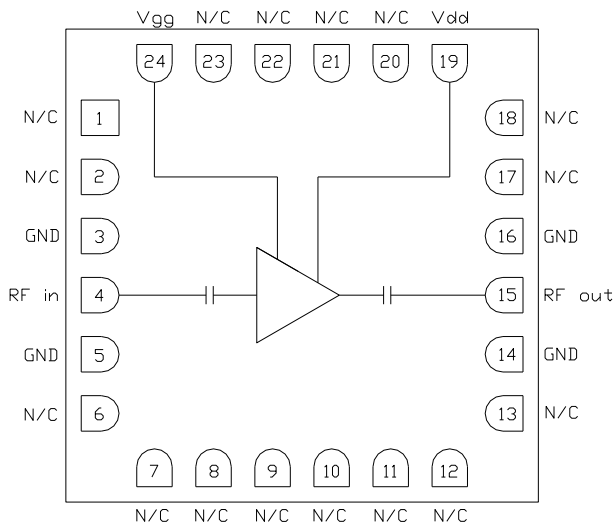

Key Features

- Ultra Low Noise Performance
- High Gain
- All Positive Supply Voltages
- Low Current Consumption
- Pb-Free RoHS Compliant 4x4 QFN Package

Ordering Information

Part No.	Description
CMD298C4	17-25 GHz Low Noise Amplifier, 100 Piece 7" Reel
CMD298C4-EVB	Evaluation Board

Electrical Performance ($V_{dd} = 3.0\text{ V}$, $V_{gg} = 1.5\text{ V}$, $T_A = 25\text{ }^\circ\text{C}$, $F = 21\text{ GHz}$)

Parameter	Min	Typ	Max	Units
Frequency Range		17 - 25		GHz
Gain		27		dB
Noise Figure		1.4		dB
Input Return Loss		10		dB
Output Return Loss		20		dB
Output P1dB		8		dBm
Output IP3		19		dBm
Supply Current		27		mA

Absolute Maximum Ratings

Parameter	Rating
Drain Voltage, V_{dd}	4 V
Gate Voltage, V_{gg}	3.25 V
RF Input Power	+20 dBm
Channel Temperature, T_{ch}	150 °C
Power Dissipation, P_{diss}	499 mW
Thermal Resistance, θ_{JC}	120.26 °C/W
Operating Temperature	-40 to 85 °C
Storage Temperature	-55 to 150 °C

Exceeding any one or combination of the maximum ratings may cause permanent damage to the device.

Recommended Operating Conditions

Parameter	Min	Typ	Max	Units
V_{dd}	1.5	3.0	3.5	V
I_{dd}		27		mA
V_{gg}	0	1.5	3.0	V

Electrical performance is measured at specific test conditions. Electrical specifications are not guaranteed over all recommended operating conditions.

Electrical Specifications ($V_{dd} = 3.0$ V, $V_{gg} = 1.5$ V, $T_A = 25$ °C)

Parameter	Min	Typ	Max	Min	Typ	Max	Units
Frequency Range	17 - 22			22 - 25			GHz
Gain	24	27.5		22	26		dB
Noise Figure		1.5	2		1.4	2	dB
Input Return Loss		10			13		dB
Output Return Loss		10			12		dB
Output P1dB		8			9		dBm
Output IP3		18			20		dBm
Supply Current	19	27	35	19	27	35	mA
Gain Temperature Coefficient		0.02			0.02		dB/°C
Noise Figure Temperature Coefficient		0.007			0.007		dB/°C

Typical Performance

Broadband Performance, $V_{dd} = 3.0\text{ V}$, $V_{gg} = 1.5\text{ V}$, $I_{dd} = 27\text{ mA}$, $T_A = 25\text{ }^\circ\text{C}$

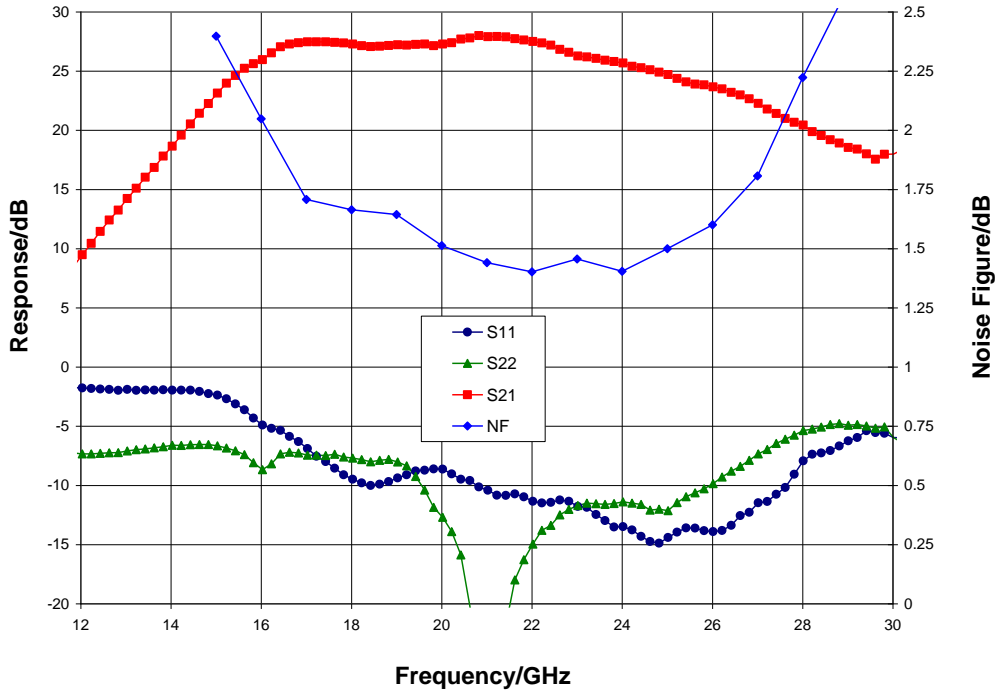

Narrow-band Performance, $V_{dd} = 3.0\text{ V}$, $V_{gg} = 1.5\text{ V}$, $I_{dd} = 27\text{ mA}$, $T_A = 25\text{ }^\circ\text{C}$

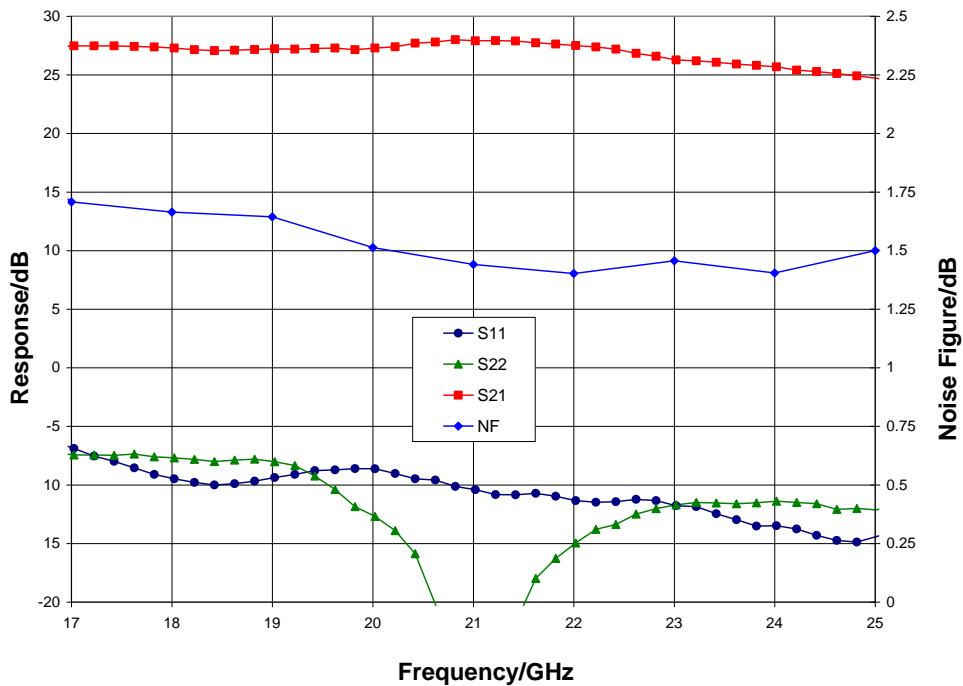

Typical Performance

Gain vs. Temperature, $V_{dd} = 3.0\text{ V}$, $V_{gg} = 1.5\text{ V}$

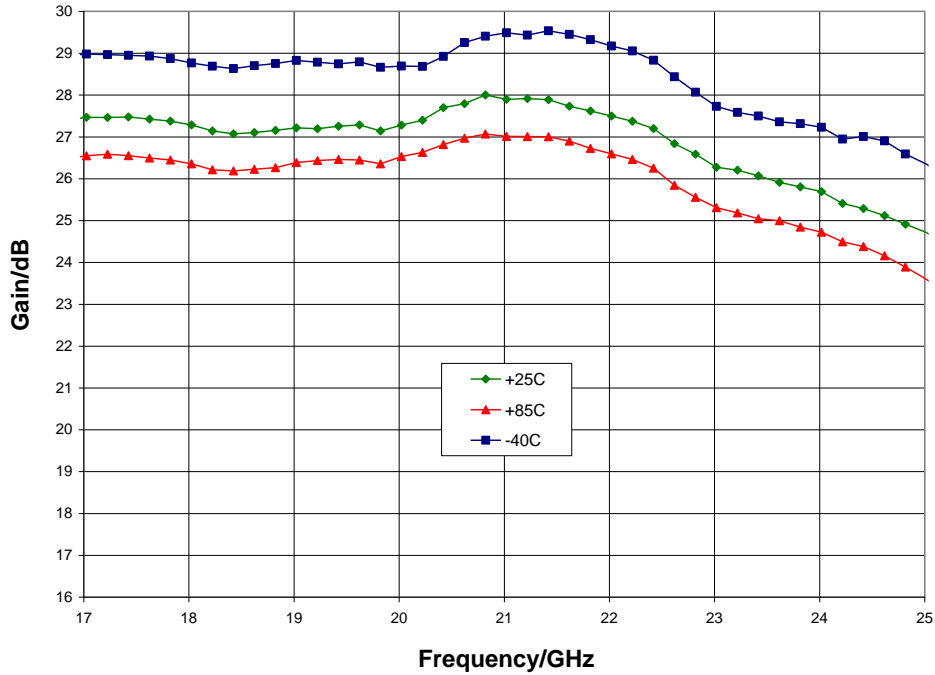

Gain vs. V_{dd} , $V_{gg} = 1.5\text{ V}$, $T_A = 25\text{ }^\circ\text{C}$

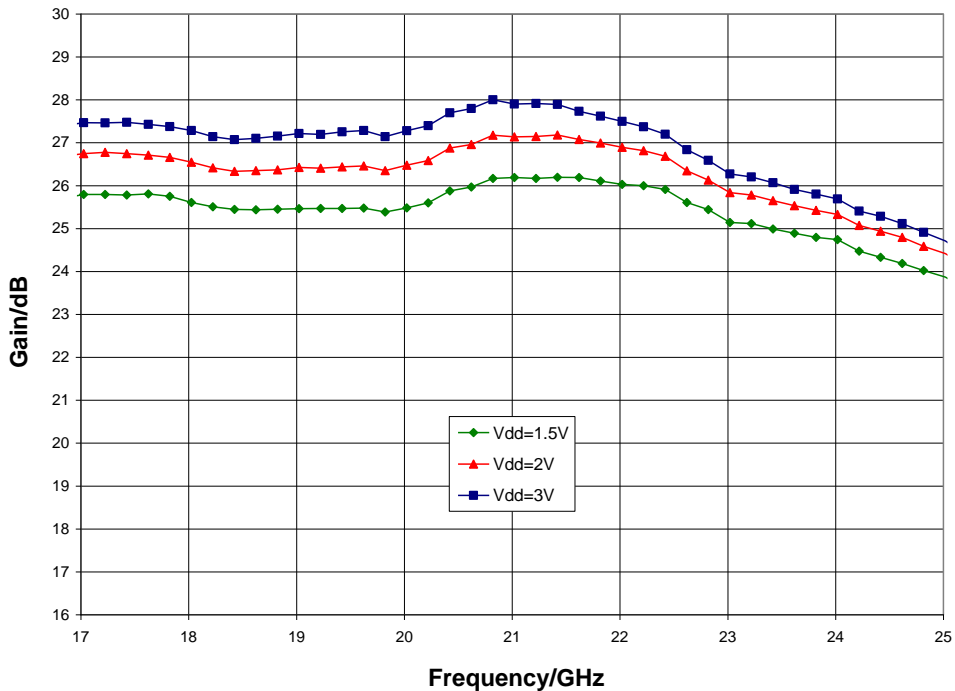

Typical Performance

Noise Figure vs. Temperature, $V_{dd} = 3.0\text{ V}$, $V_{gg} = 1.5\text{ V}$

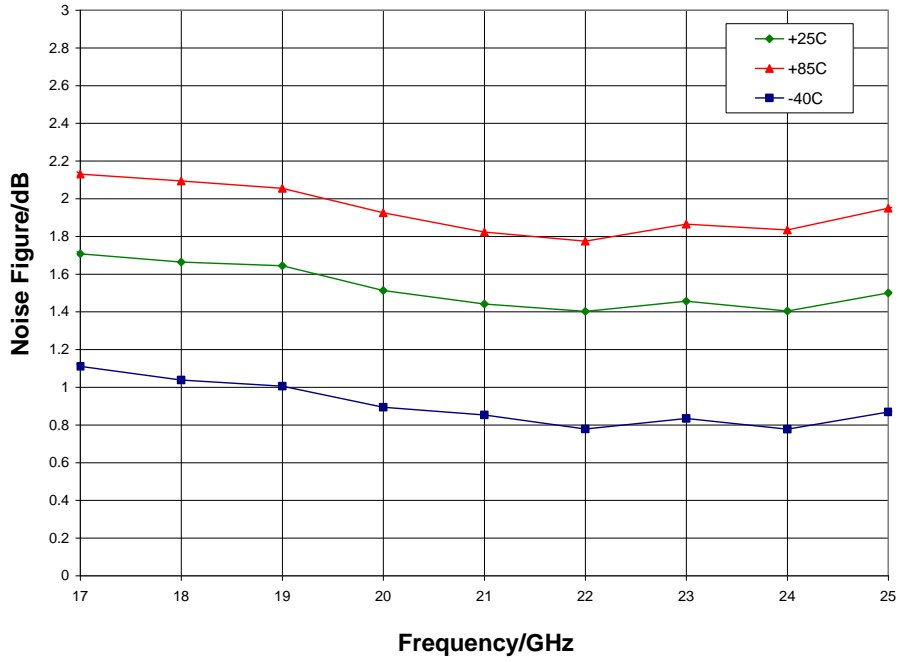

Noise Figure vs. V_{dd} , $V_{gg} = 1.5\text{ V}$, $T_A = 25\text{ }^\circ\text{C}$

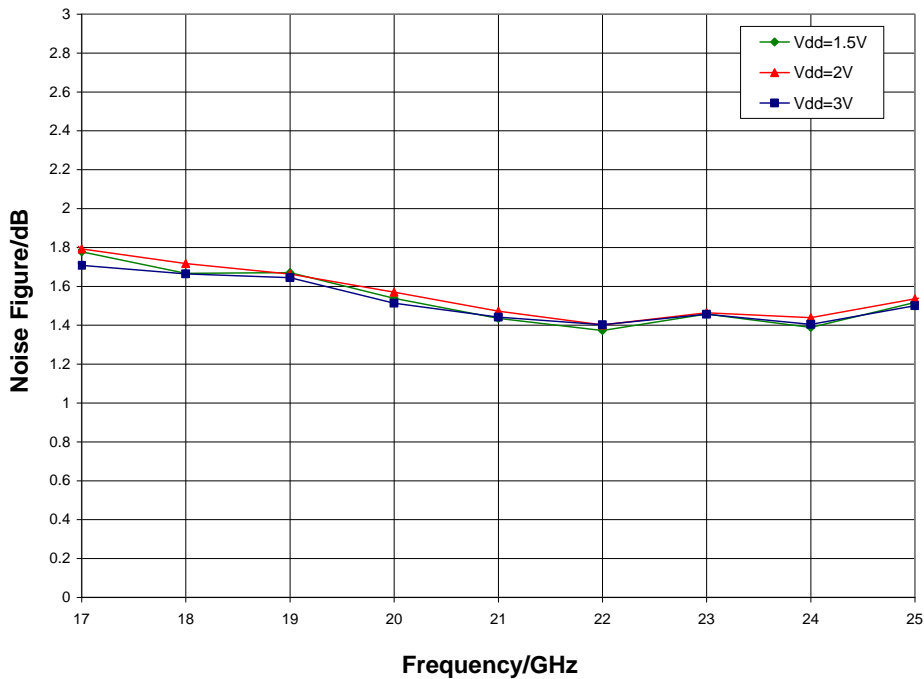

Typical Performance

P1dB vs. Temperature, $V_{dd} = 3.0\text{ V}$, $V_{gg} = 1.5\text{ V}$

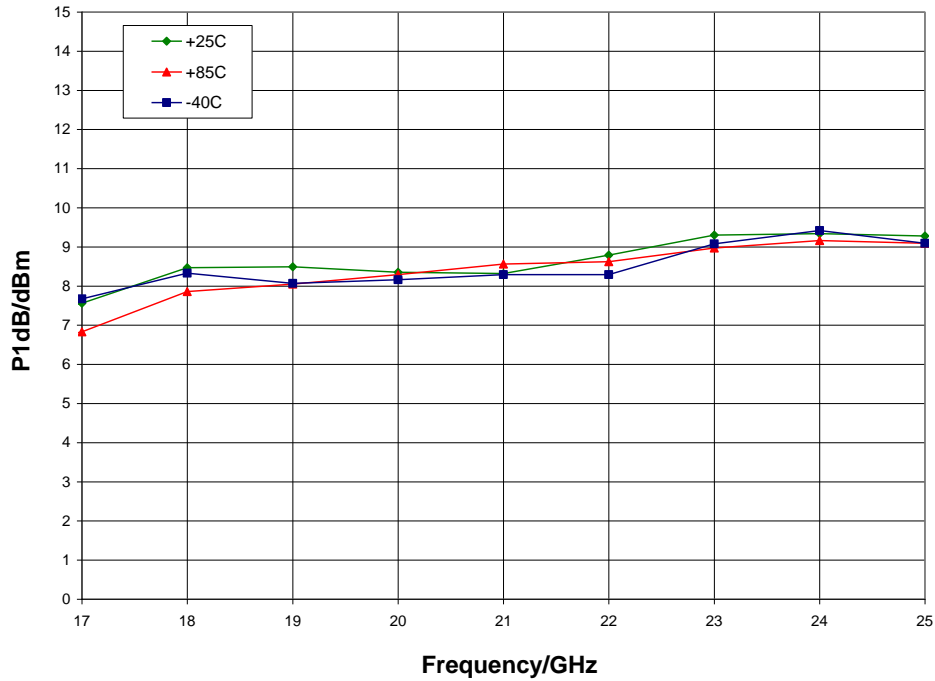

P1dB vs. V_{dd} , $V_{gg} = 1.5\text{ V}$, $T_A = 25\text{ }^\circ\text{C}$

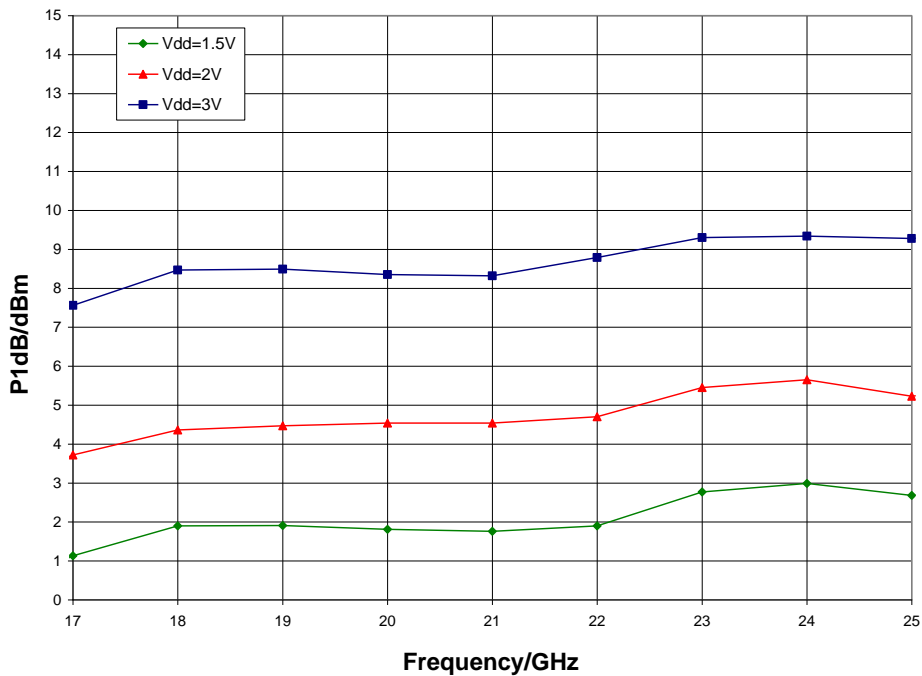

Typical Performance

Psat vs. Temperature, $V_{dd} = 3.0\text{ V}$, $V_{gg} = 1.5\text{ V}$

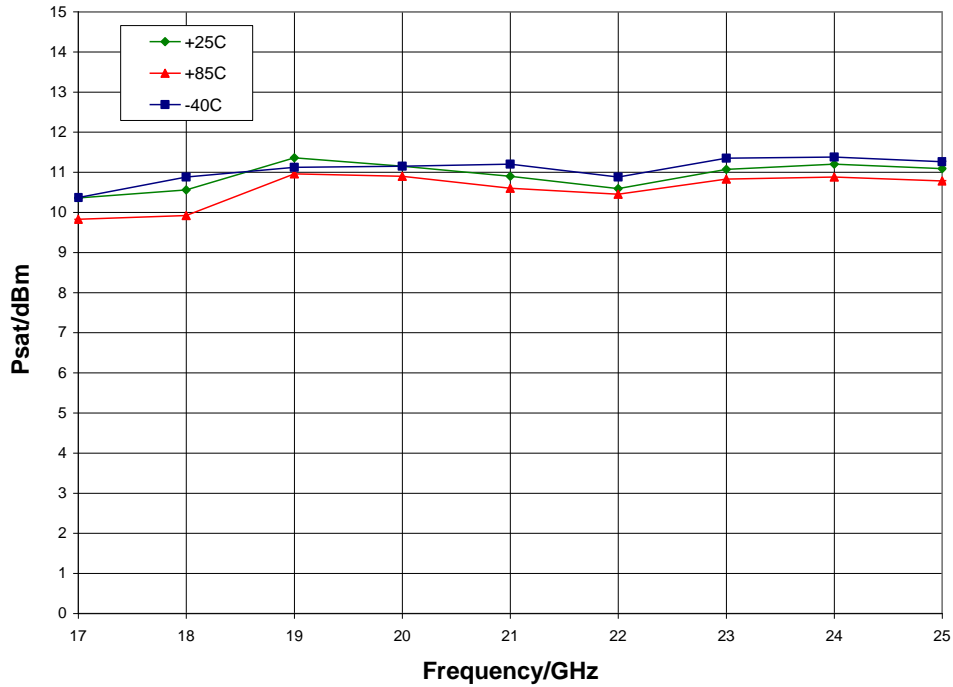

Psat vs. V_{dd} , $V_{gg} = 1.5\text{ V}$, $T_A = 25\text{ }^\circ\text{C}$

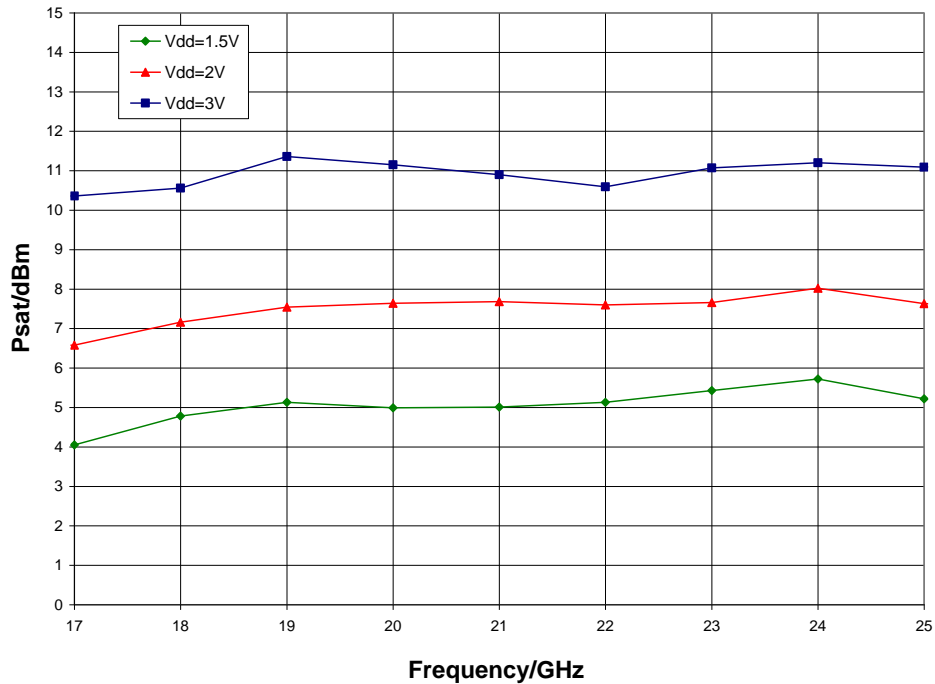

Typical Performance

Output IP3 vs. Temperature, $V_{dd} = 3.0\text{ V}$, $V_{gg} = 1.5\text{ V}$

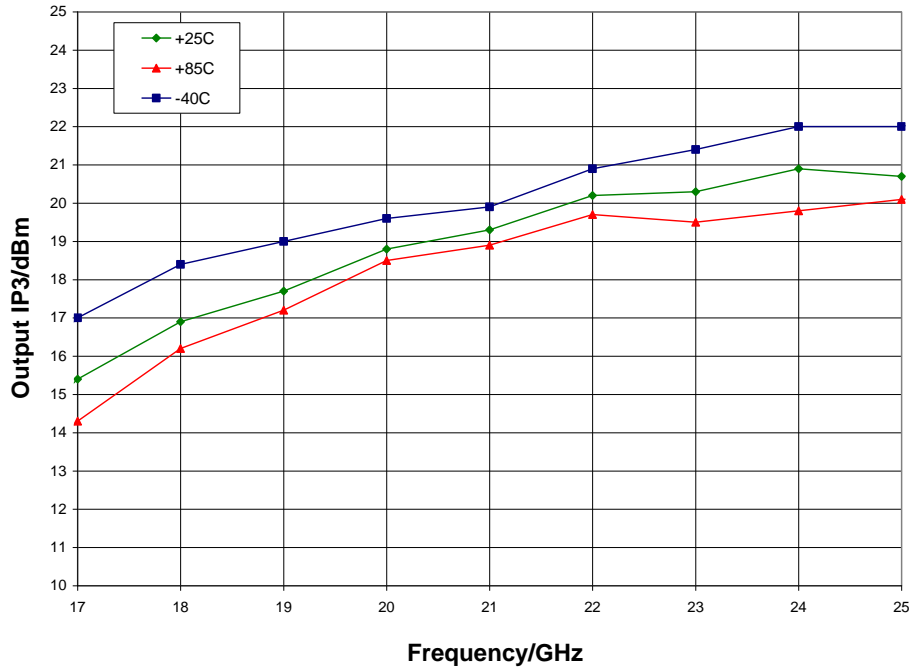

Output IP3 vs. V_{dd} , $V_{gg} = 1.5\text{ V}$, $T_A = 25\text{ °C}$

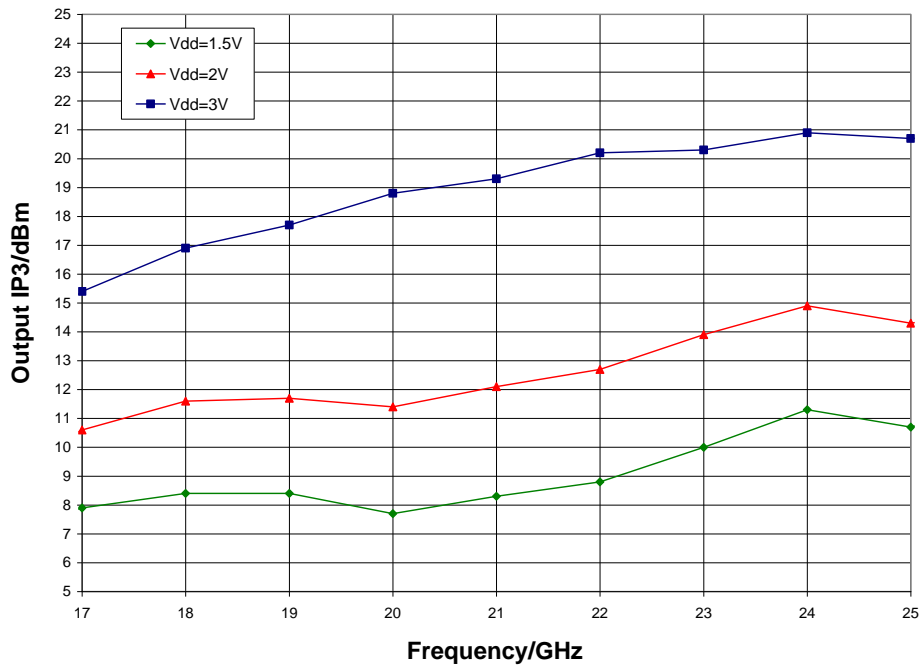

Mechanical Information

Package Information and Dimensions

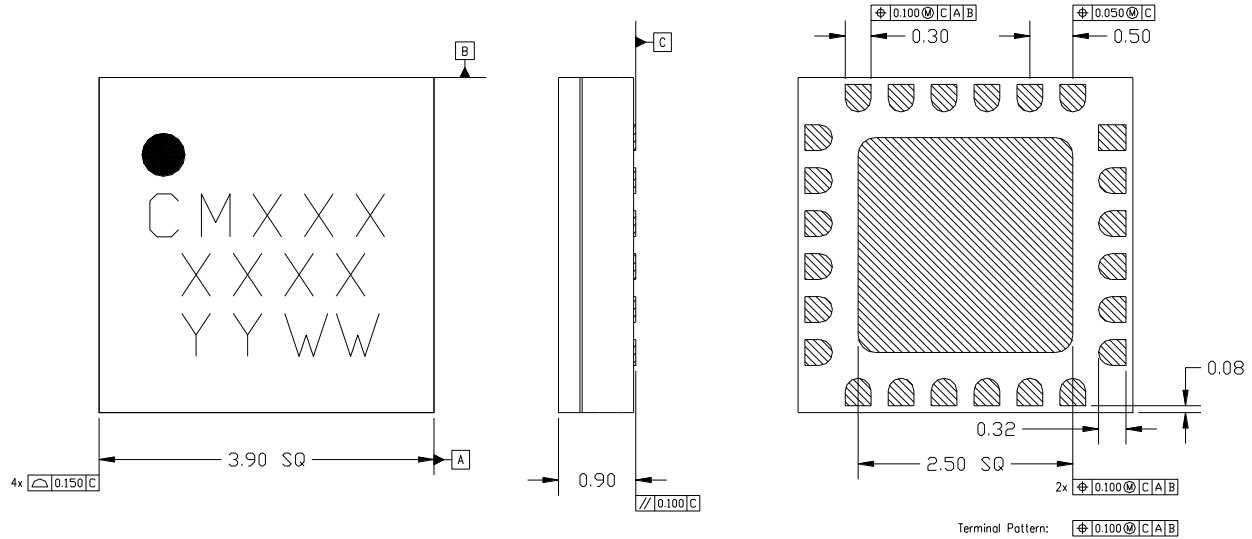

Notes:

1. All dimensions shown in mm.
2. Material: Black alumina
3. Lead finish:
 - 3.1. Ni: 8.89um max 1.27um min
 - 3.2. Pd: 0.17um max, 0.07um min
 - 3.3. Au: 0.254um max, 0.03um min
4. Marking
 - 4.1. Line 1: Part number
 - 4.1.1. Example: CMD298C4 shall be marked as CM298
 - 4.2. Line 2: Lot number
 - 4.3. Line 3: Date code - Last 2 digits of the year of manufacture followed by a 2 digit week code
5. Alternate pin #1 identifier is a single square pad
6. Alternate die paddle may have chamfered corners

Recommended PCB Land Pattern

Qorvo recommends that the user develop the land pattern that will provide the best design for proper solder reflow and device attach for their specific application. Please review Qorvo Application Note AN 105 for a recommended land pattern approach.

Recommended Solder Reflow Profile

Qorvo recommends screen printing with belt furnace reflow to ensure proper solder reflow and device attach. Please review Qorvo Application Note AN 102 for a recommended solder reflow profile.

Pin Description

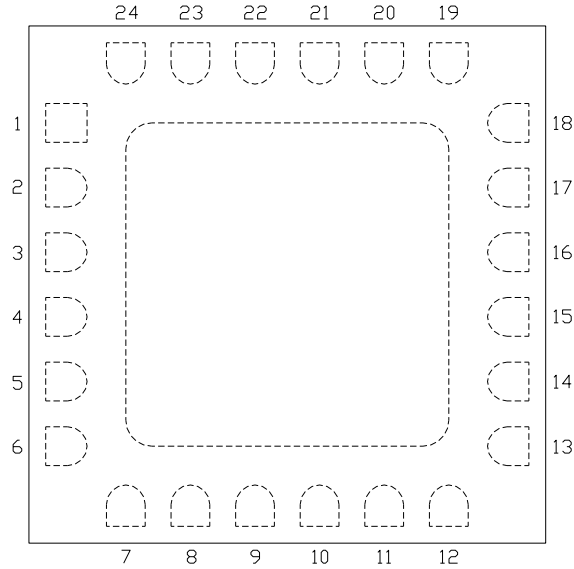

Functional Description

Pin	Function	Description	Schematic
1, 2, 6 - 13, 17, 18, 20 - 23	N/C	No connection required These pins may be connected to RF / DC ground	
3, 5, 14, 16 and die paddle	Ground	Connect to RF / DC ground	
4	RF in	DC blocked and 50 ohm matched	
15	RF out	DC blocked and 50 ohm matched	
19	V _{dd}	Power supply voltage Decoupling and bypass caps required	
24	V _{gg}	Power supply voltage Decoupling and bypass caps required	

Applications Information

Application Circuit

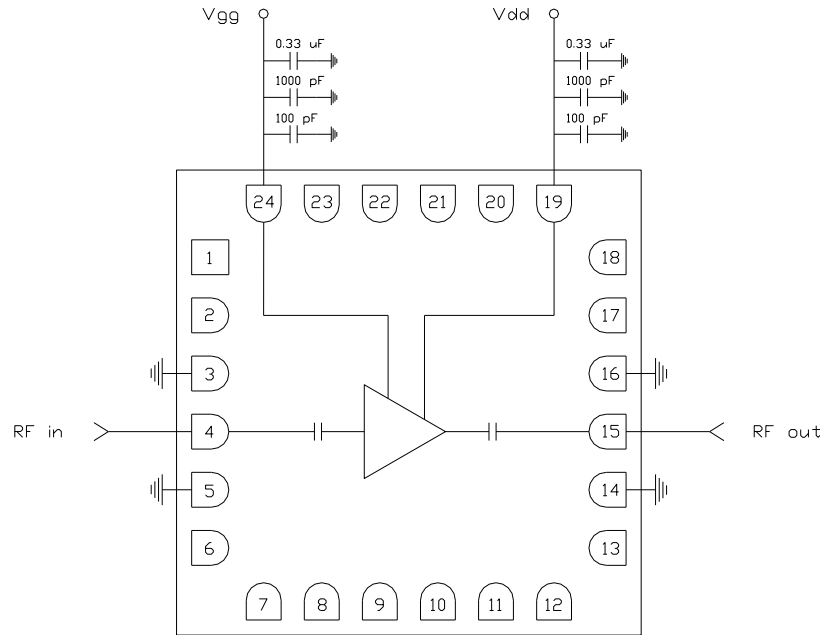

Biasing and Operation

The CMD298C4 is biased with a positive drain supply and positive gate supply. Sequencing of the drain and gate supply is not required. Performance is optimized when the drain voltage is set to +3.0 V, though it may be set to a minimum of +1.5 V and a maximum of +3.5 V. The recommended gate voltage is +1.5 V.

Turn ON procedure:

1. Apply drain voltage V_{dd} and set to +3 V
2. Apply gate voltage V_{gg} and set to +1.5 V

Turn OFF procedure:

1. Turn off gate voltage V_{gg}
2. Turn off drain voltage V_{dd}

Refer to Application Note 103: Amplifier Biasing Techniques for instructions on how to implement a single supply biasing scheme.

RF power can be applied at any time.

Applications Information

Evaluation Board

The circuit board shown has been developed for optimized assembly at Qorvo. A sufficient number of via holes should be used to connect the top and bottom ground planes. As surface mount processes vary, careful process development is recommended.

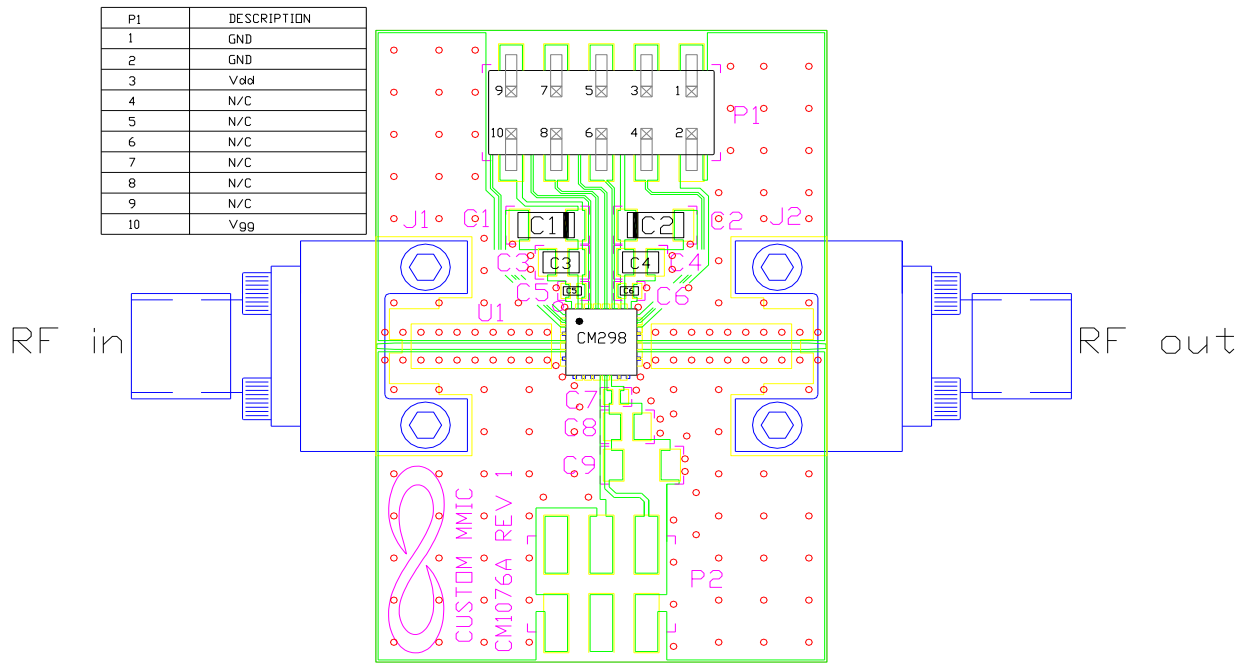

Designator	Value	Description
J1, J2		SMA End Launch Connector
P1		10 Pin Header
C1, C2	0.33 μ F	Capacitor, Tantalum
C3, C4	1000 pF	Capacitor, 0603
C5, C6	100 pF	Capacitor, 0402
U1		CMD298C4 Low Noise Amplifier
PCB		CM1076A Evaluation PCB

GaAs MMIC devices are susceptible to damage from Electrostatic Discharge. Proper precautions should be observed during handling, assembly and test.

Handling Precautions

Parameter	Rating	Standard
ESD – Human Body Model (HBM)	Class 1A	ESDA / JEDEC JS-001-2012
MSL – Moisture Sensitivity Level	Level 1	JEDEC standard IPC/JEDEC J-STD-020



Caution!
ESD-Sensitive Device

RoHS Compliance

This part is compliant with 2011/65/EU RoHS directive (Restrictions on the Use of Certain Hazardous Substances in Electrical and Electronic Equipment) as amended by Directive 2015/863/EU.

This product also has the following attributes:

- Lead Free
- Antimony Free
- TBBP-A (C₁₅H₁₂Br₄O₂) Free
- SVHC Free
- Halogen Free
- PFOS Free

Contact Information

For the latest specifications, additional product information, worldwide sales and distribution locations:

Web: www.qorvo.com

Tel: 1-844-890-8163

Email: customer.support@qorvo.com

Important Notice

The information contained in this Data Sheet and any associated documents (“Data Sheet Information”) is believed to be reliable; however, Qorvo makes no warranties regarding the Data Sheet Information and assumes no responsibility or liability whatsoever for the use of said information. All Data Sheet Information is subject to change without notice. Customers should obtain and verify the latest relevant Data Sheet Information before placing orders for Qorvo® products. Data Sheet Information or the use thereof does not grant, explicitly, implicitly or otherwise any rights or licenses to any third party with respect to patents or any other intellectual property whether with regard to such Data Sheet Information itself or anything described by such information.

DATA SHEET INFORMATION DOES NOT CONSTITUTE A WARRANTY WITH RESPECT TO THE PRODUCTS DESCRIBED HEREIN, AND QORVO HEREBY DISCLAIMS ANY AND ALL WARRANTIES WITH RESPECT TO SUCH PRODUCTS WHETHER EXPRESS OR IMPLIED BY LAW, COURSE OF DEALING, COURSE OF PERFORMANCE, USAGE OF TRADE OR OTHERWISE, INCLUDING THE IMPLIED WARRANTIES OF MERCHANTABILITY AND FITNESS FOR A PARTICULAR PURPOSE. Without limiting the generality of the foregoing, Qorvo® products are not warranted or authorized for use as critical components in medical, life-saving, or life-sustaining applications, or other applications where a failure would reasonably be expected to cause severe personal injury or death. Applications described in the Data Sheet Information are for illustrative purposes only. Customers are responsible for validating that a particular product described in the Data Sheet Information is suitable for use in a particular application.

© 2022 Qorvo US, Inc. All rights reserved. This document is subject to copyright laws in various jurisdictions worldwide and may not be reproduced or distributed, in whole or in part, without the express written consent of Qorvo US, Inc. | QORVO® is a registered trademark of Qorvo US, Inc.