

General Description

The Qorvo QPD1022 is a 10 W (P_{3dB}) discrete GaN on SiC HEMT which operates from DC to 12 GHz. This wideband device is a single stage unmatched power amplifier transistor in an over-molded plastic package. The wide bandwidth of the QPD1022 makes it suitable for many different applications from DC to 12 GHz.

The device is housed in an industry-standard 3 x 3 mm surface mount QFN package.

Lead-free and ROHS compliant

Evaluation boards are available upon request.

Functional Block Diagram

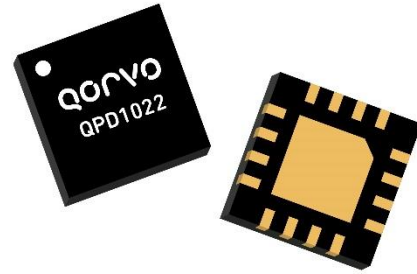
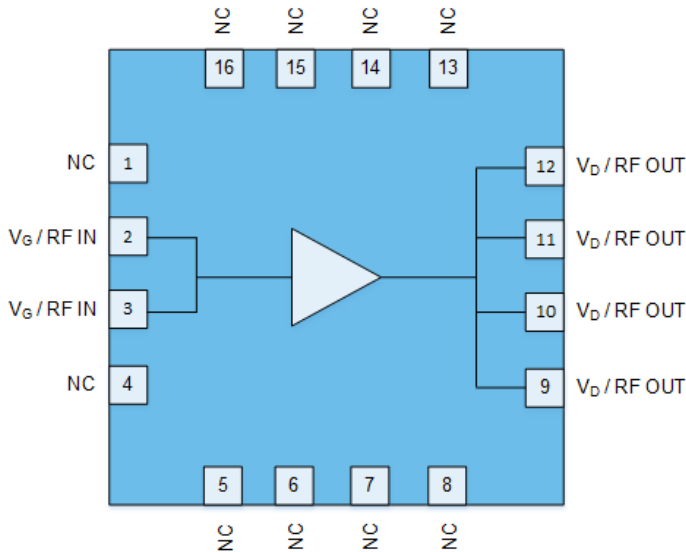

16 Pin QFN (3 x 3 x 0.85 mm)

Product Features¹

- Frequency: DC to 12 GHz
- Output Power (P_{3dB}): 11 W¹
- Linear Gain: 24.0 dB¹
- Typical PAE_{3dB}: 68.8 %¹
- Operating Voltage: 32 V
- Low thermal resistance package
- CW and Pulse capable
- 3 x 3 mm package

Note 1: @ 2 GHz (Loadpull)

Applications

- Military radar
- Civilian radar
- Land mobile and military radio communications
- Test instrumentation
- Wideband or narrowband amplifiers
- Jammers

Ordering Information

Part No.	Description
QPD1022S2	2 Piece Sample Bag
QPD1022SQ	25 Piece Sample Bag
QPD1022SR	100 Piece 7" Reel
QPD1022EVB01	3.1 – 3.5 GHz EVB

Absolute Maximum Ratings^{1,2}

Parameter	Rating	Units
Breakdown Voltage, V_{BDG}	100	V
Gate Voltage Range, V_G	-7 – +2	V
Drain Current, I_D	2.4	A
Gate Current Range, I_G^1	0.9	mA
Power Dissipation, CW, P_{DISS}	17.5	W
RF Input Power at 3.3 GHz, CW, 50 Ω , T = 25 °C	+29	dBm
Mounting Temperature (30 Seconds)	320	°C
Storage Temperature	-65 to +150	°C

Notes:

1. At Channel temperature of 160°C.
2. Operation of this device outside the parameter ranges given above may cause permanent damage.

Recommended Operating Conditions^{1, 2, 3, 4}

Parameter	Min	Typ	Max	Units
Operating Temp. Range	-40	+25	+85	°C
Drain Voltage Range, V_D	+12	+32	+40	V
Drain Bias Current, I_{DQ}	–	50	–	mA
Drain Current, I_D	–	610	–	mA
Gate Voltage, V_G^4	–	-2.8	–	V
Power Dissipation, CW (P_D) ²	–	–	13.8	W
Power Dissipation, Pulsed (P_D) ^{2, 3}	–	–	18.0	W

Notes:

1. Electrical performance is measured under conditions noted in the electrical specifications table. Specifications are not guaranteed over all recommended operating conditions.
2. Back plane of package at 85 °C
3. Pulse Width = 100 us, Duty Cycle = 20%
4. To be adjusted to desired I_{DQ}

Pulsed Characterization – Load Pull Performance – Power Tuned¹

Parameters	Typical Values						Unit
	2	3	4	6	9	10	
Frequency, F	2	3	4	6	9	10	GHz
Linear Gain, G_{LIN}	24.0	21.9	19.7	16.1	12.2	10.7	dB
Output Power at 3dB compression point, P_{3dB}	40.4	40.0	40.3	40.4	40.0	39.9	dBm
Power-Added-Efficiency at 3dB compression point, PAE_{3dB}	58.0	52.8	57.0	54.5	45.0	40.0	%
Gain at 3dB compression point	21.0	18.9	16.7	13.1	9.2	7.7	dB

Notes:

1. Test conditions unless otherwise noted: $V_D = 32\text{ V}$, $I_{DQ} = 50\text{ mA}$, Temp = +25 °C

Pulsed Characterization – Load Pull Performance – Efficiency Tuned¹

Parameters	Typical Values						Unit
	2	3	4	6	9	10	
Frequency	2	3	4	6	9	10	GHz
Linear Gain, G_{LIN}	25.6	23.4	21.3	16.9	12.9	11.9	dB
Output Power at 3dB compression point, P_{3dB}	36.8	39.0	38.3	39.4	39.4	38.7	dBm
Power-Added-Efficiency at 3dB compression point, PAE_{3dB}	68.8	66.	69.4	61.2	50.3	46.3	%
Gain at 3dB compression point, G_{3dB}	22.6	20.4	18.3	13.9	9.9	8.9	dB

Notes:

- 1- Test conditions unless otherwise noted: $V_D = 32\text{ V}$, $I_{DQ} = 50\text{ mA}$, Temp = +25 °C

RF Characterization – 3.1 – 3.5 GHz EVB Performance At 3.3 GHz¹

Parameter	Min	Typ	Max	Units
Linear Gain, G_{LIN}	–	16.3	–	dB
Output Power at 3dB compression point, P_{3dB}	–	39.9	–	dBm
Drain Efficiency at 3dB compression point, $DEFF_{3dB}$	–	58.7	–	%
Gain at 3dB compression point, G_{3dB}	–	13.3	–	dB

Notes:

1. $V_D = 32\text{ V}$, $I_{DQ} = 50\text{ mA}$, Temp = +25 °C, Pulse Width = 100 us, Duty Cycle = 20%

RF Characterization – Mismatch Ruggedness at 3.3 GHz^{1,2}

Symbol	Parameter	dB Compression	Typical
VSWR	Impedance Mismatch Ruggedness	3	10:1

Notes:

1. Test conditions unless otherwise noted: $T_A = 25\text{ °C}$, $V_D = 32\text{ V}$, $I_{DQ} = 50\text{ mA}$
2. Driving input power is determined at pulsed compression under matched condition at EVB output connector.

Thermal and Reliability Information – CW¹

Peak IR Surface Temperature vs. Dissipated Power
 Surface of QFN Base Fixed @ 85°C

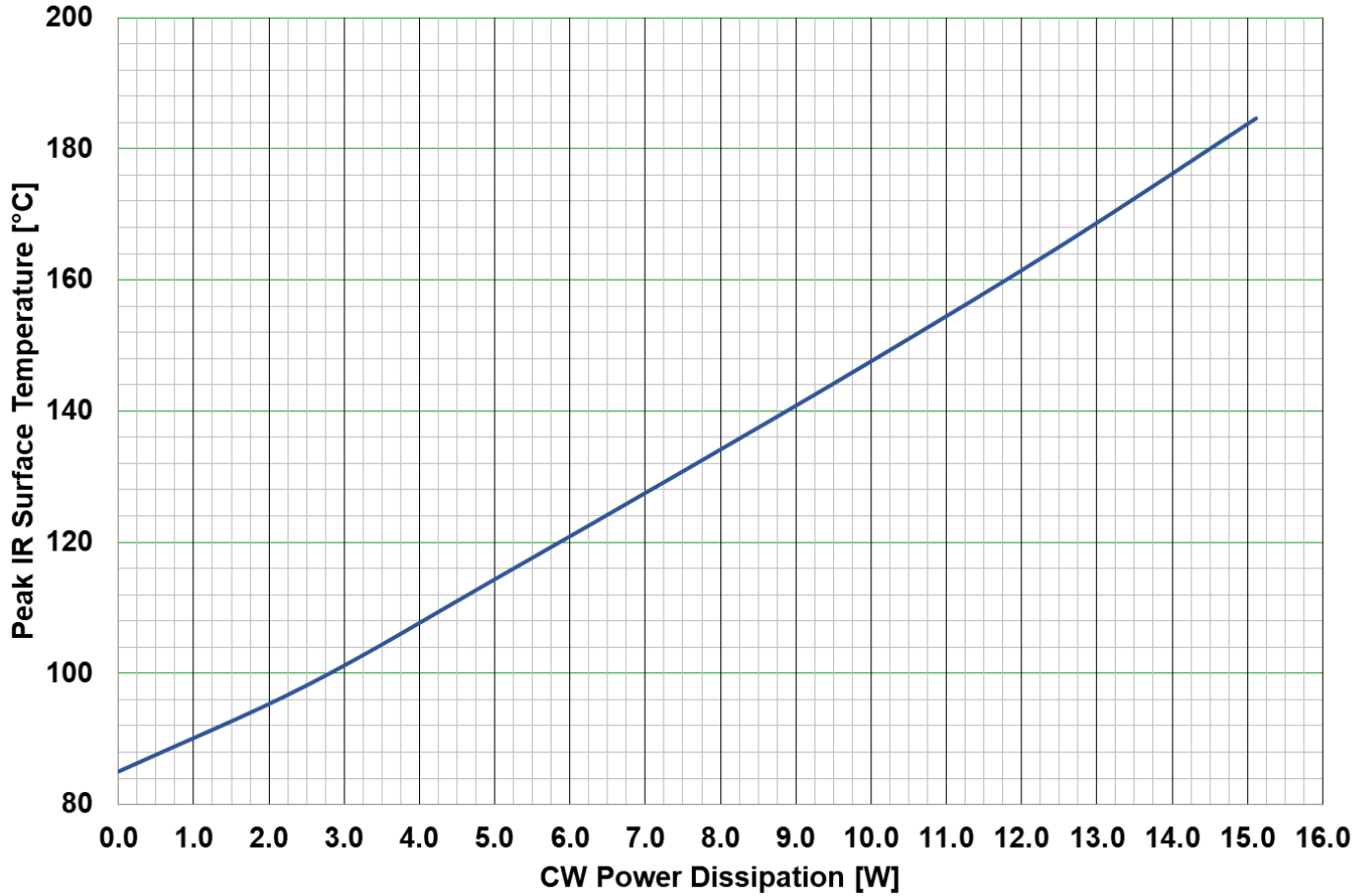

Parameter	Conditions	Values	Units
Thermal Resistance, IR ¹ (θ_{JC})	85 °C back side temperature	6.2	°C/W
Peak IR Surface Temperature ¹ (T_{CH})	7.6 W P _{diss} , CW	132	°C

Notes:

- 1- Refer to the following document: [GaN Device Channel Temperature, Thermal Resistance, and Reliability Estimates](#)

Thermal and Reliability Information – Pulsed¹

Peak IR Surface Temperature vs. Dissipated Power
 Surface of QFN Base Fixed @ 85°C

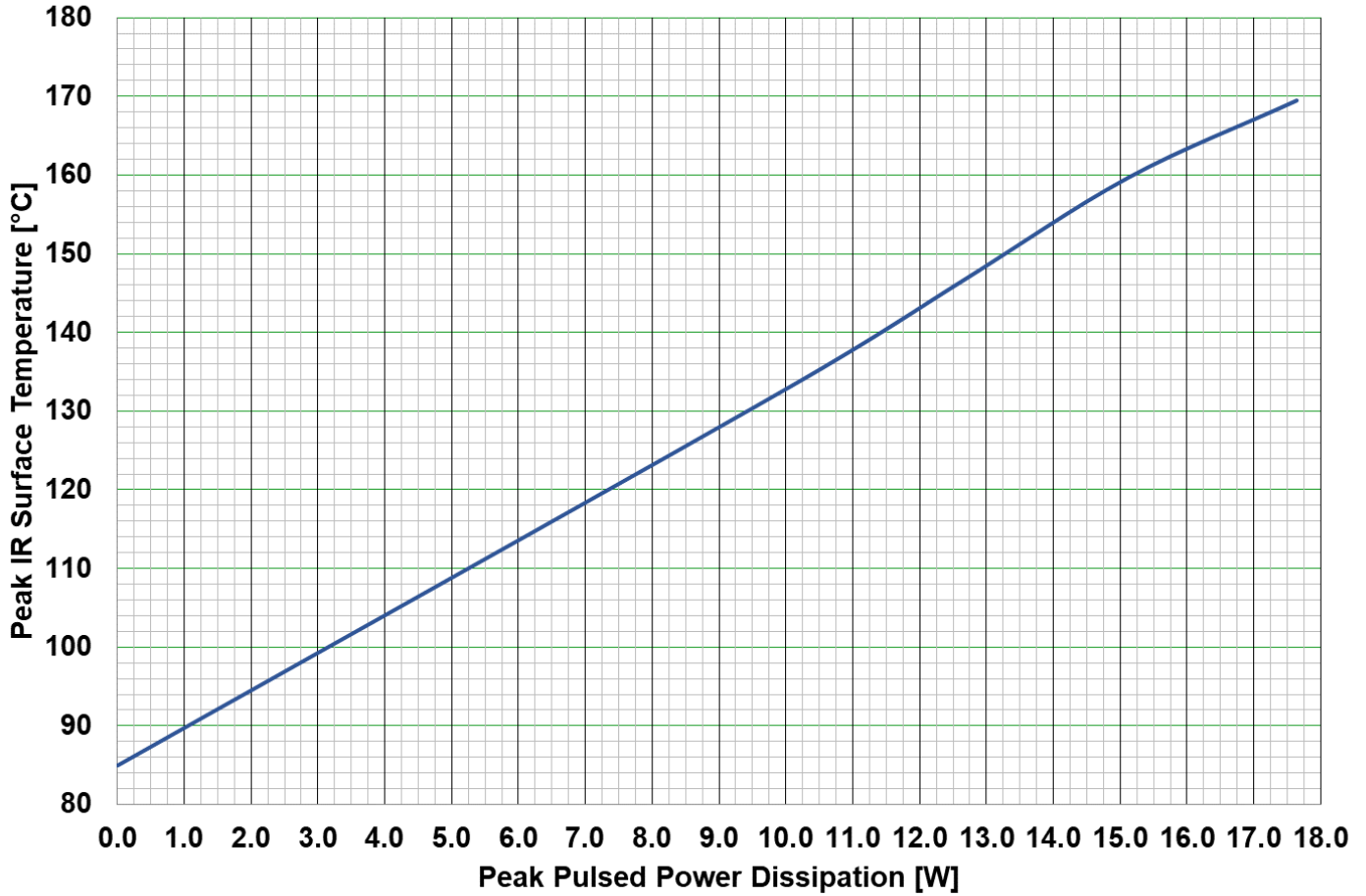

Parameter	Conditions	Values	Units
Thermal Resistance, IR ¹ (θ_{JC})	85 °C back side temperature	4.7	°C/W
Peak IR Surface Temperature ¹ (T_{CH})	7.6 W P _{diss} , 100us PW, 20% Duty cycle	121	°C

Notes:

- 1- Refer to the following document: [GaN Device Channel Temperature, Thermal Resistance, and Reliability Estimates](#)

Load Pull Smith Charts^{1,2}

Notes:

1. $V_d = 32\text{ V}$, $I_{DQ} = 50\text{ mA}$, Pulsed signal with 100 us pulse width and 20 % duty cycle.
2. See page 17 for load pull and source pull reference planes.

2 GHz, Load-pull

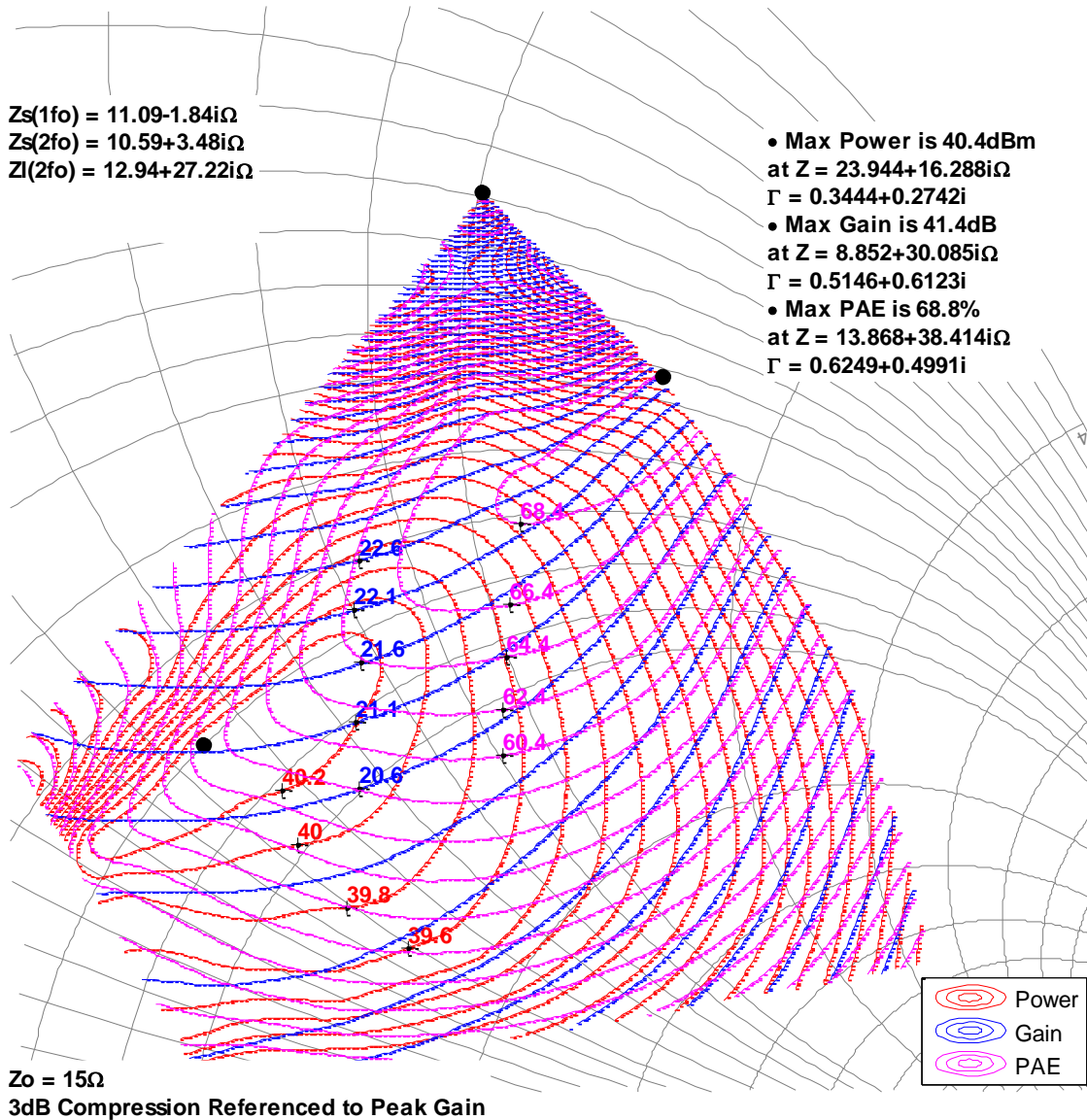

Load Pull Smith Charts^{1,2}

Notes:

1. $V_d = 32\text{ V}$, $I_{DQ} = 50\text{ mA}$, Pulsed signal with 100 us pulse width and 20 % duty cycle.
2. See page 17 for load pull and source pull reference planes.

3 GHz, Load-pull

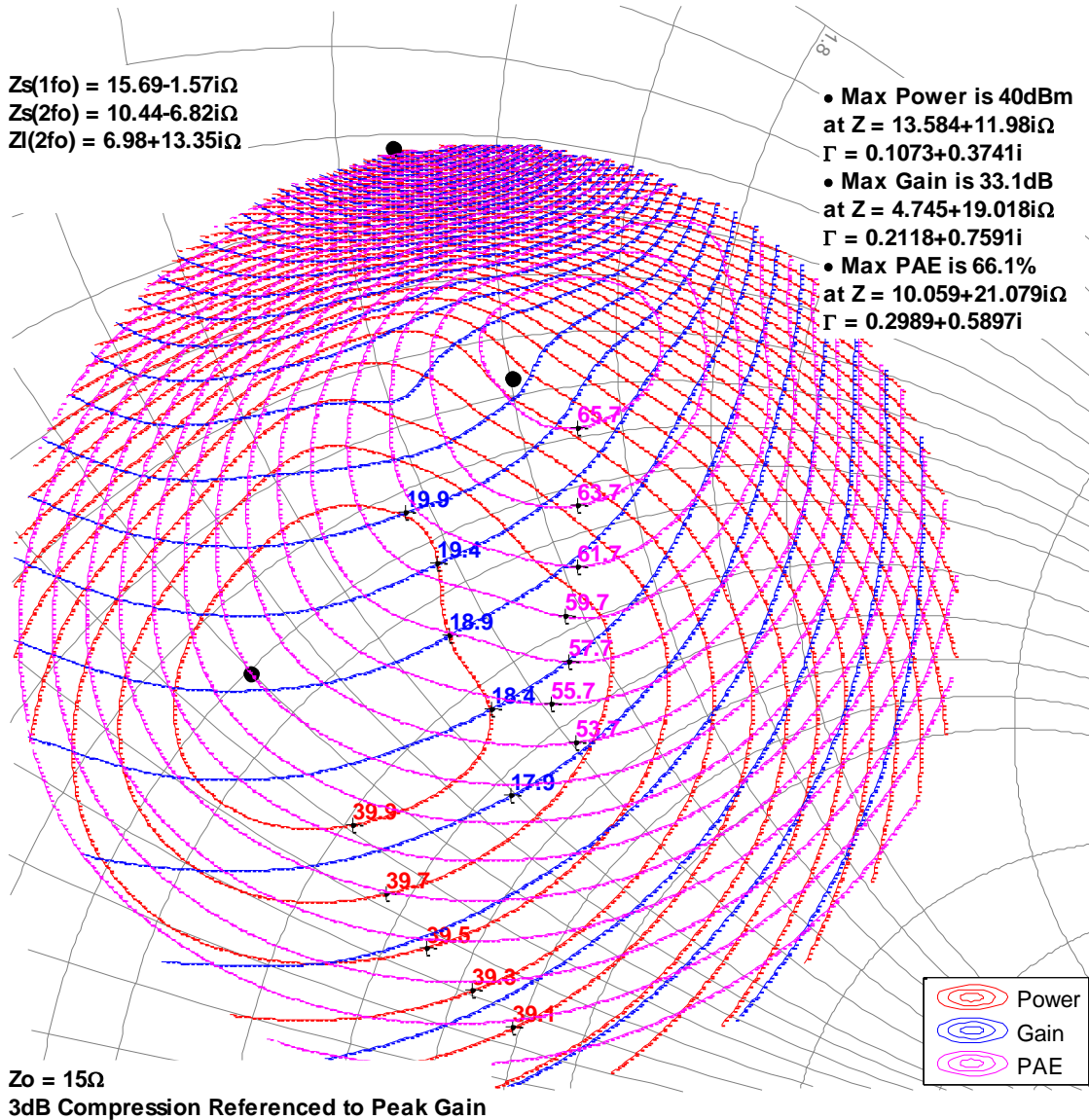

Load Pull Smith Charts^{1,2}

Notes:

1. $V_d = 32\text{ V}$, $I_{DQ} = 50\text{ mA}$, Pulsed signal with 100 us pulse width and 20 % duty cycle.
2. See page 17 for load pull and source pull reference planes.

4 GHz, Load-pull

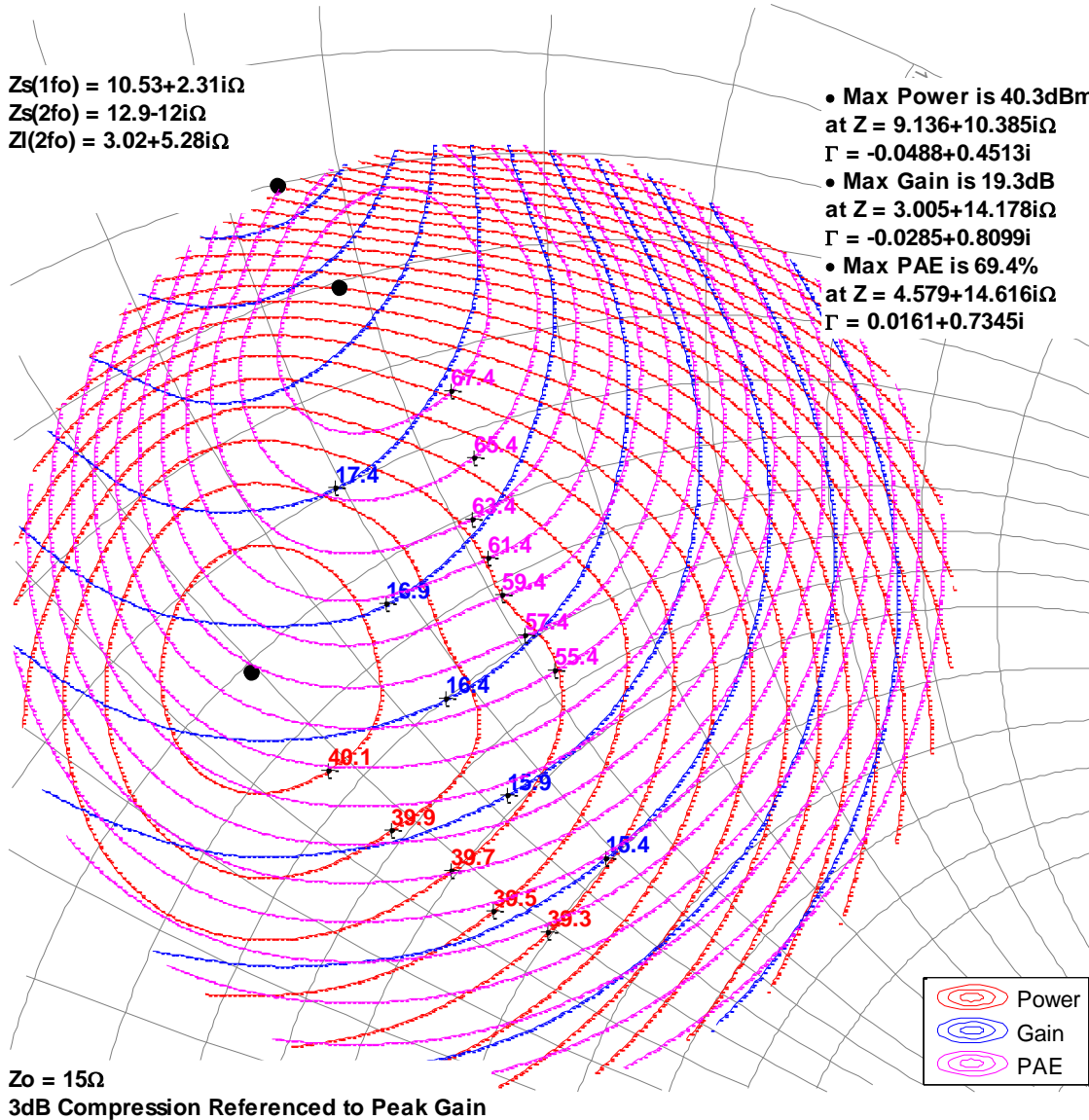

Load Pull Smith Charts^{1,2}

Notes:

1. $V_d = 32\text{ V}$, $I_{DQ} = 50\text{ mA}$, Pulsed signal with 100 us pulse width and 20 % duty cycle.
2. See page 17 for load pull and source pull reference planes.

6 GHz, Load-pull

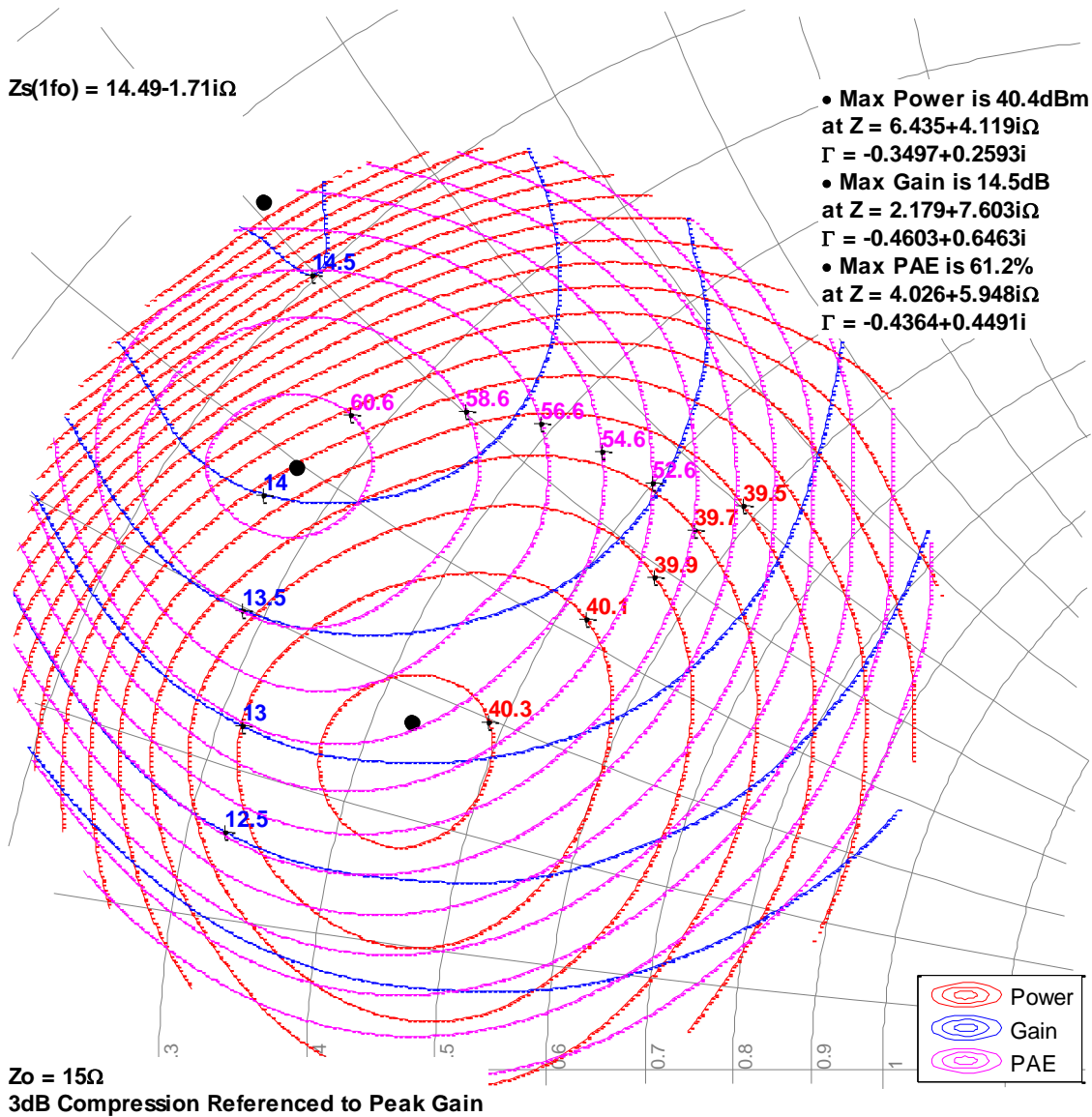

Load Pull Smith Charts^{1,2}

Notes:

1. $V_d = 32\text{ V}$, $I_{DQ} = 50\text{ mA}$, Pulsed signal with 100 us pulse width and 20 % duty cycle.
2. See page 17 for load pull and source pull reference planes.

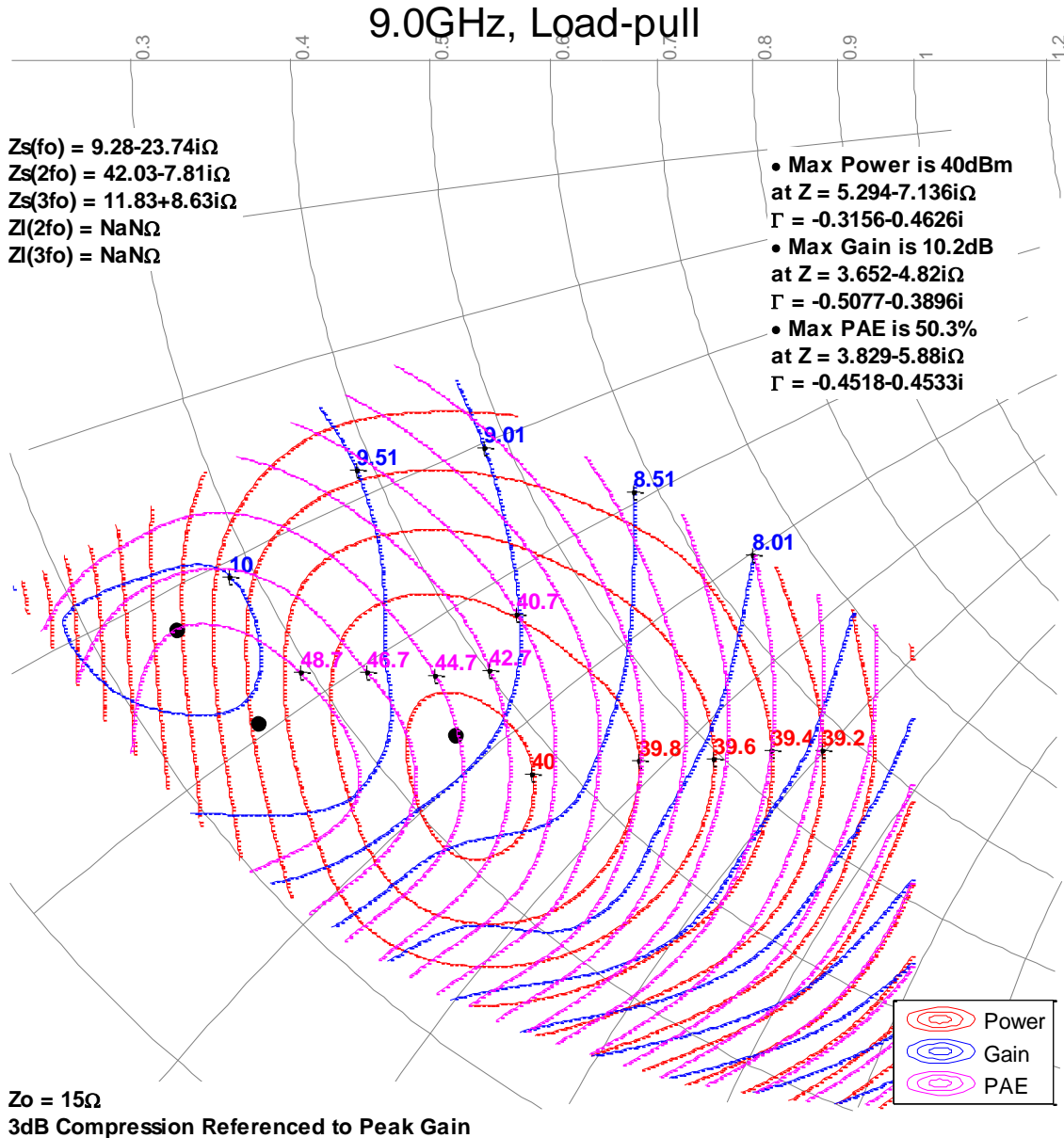

Load Pull Smith Charts^{1,2}

Notes:

1. $V_d = 32\text{ V}$, $I_{DQ} = 50\text{ mA}$, Pulsed signal with 100 us pulse width and 20 % duty cycle.
2. See page 17 for load pull and source pull reference planes.

10.0GHz, Load-pull

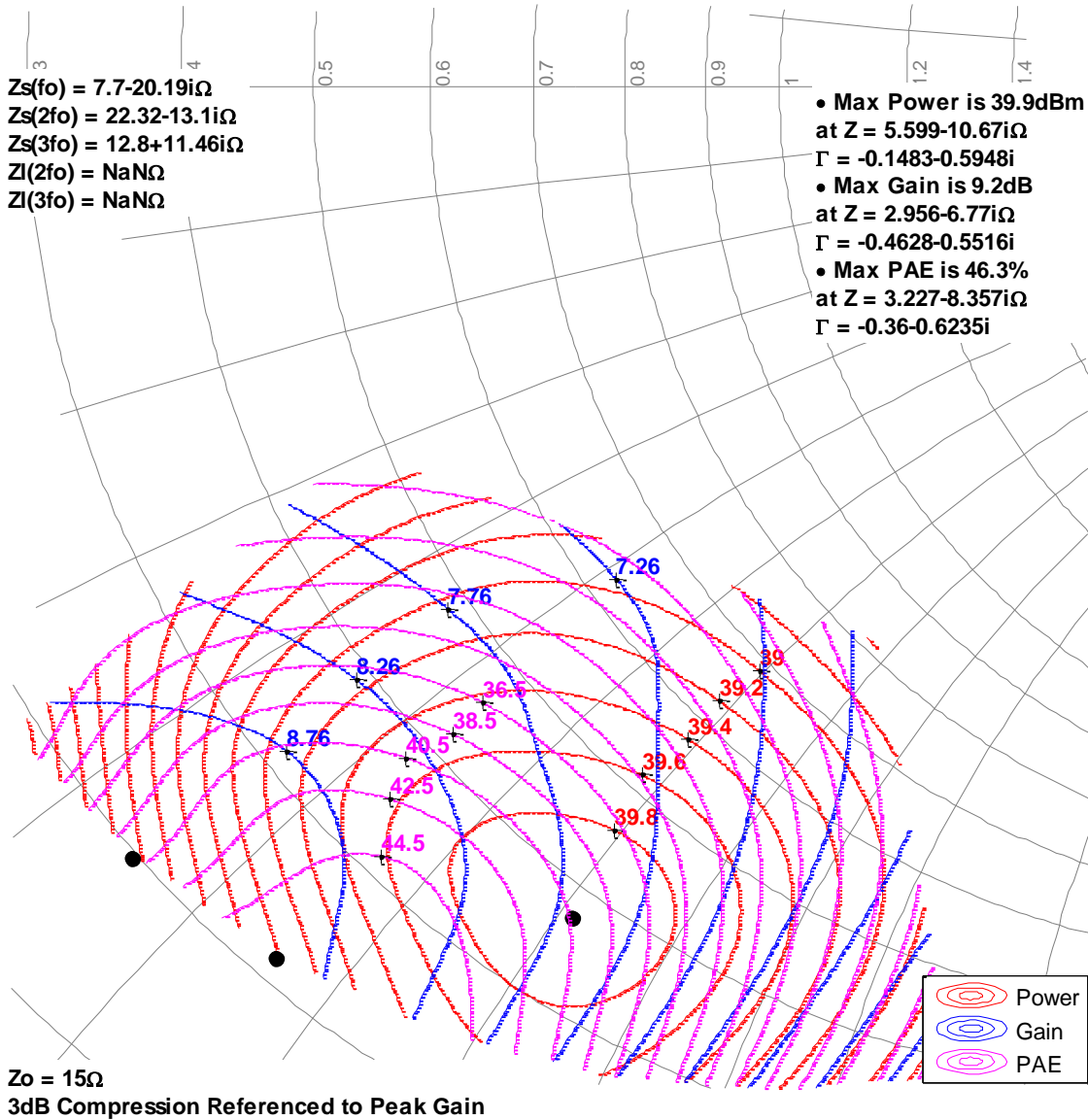

Typical Performance – Load Pull Drive-up^{1, 2}

Notes:

1. Pulsed signal with 100 us pulse width and 20 % duty cycle, $V_d = 32\text{ V}$, $I_{DQ} = 50\text{ mA}$
2. See page 17 for load pull and source pull reference planes where the performance was measured.

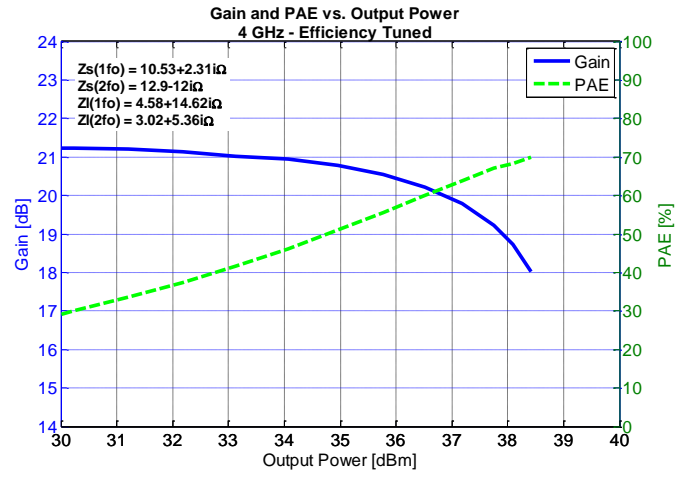
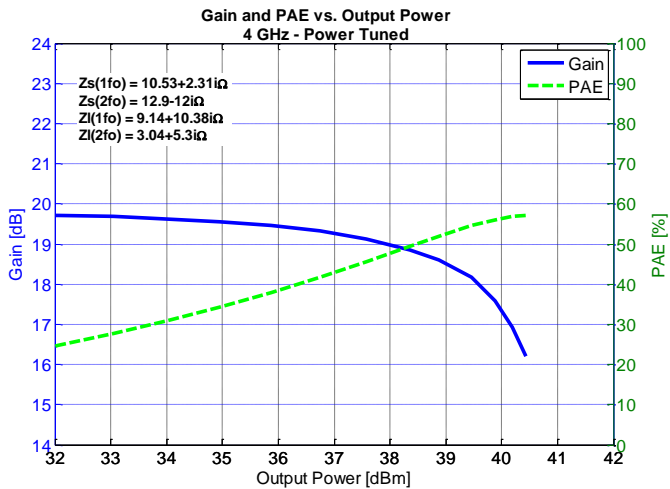
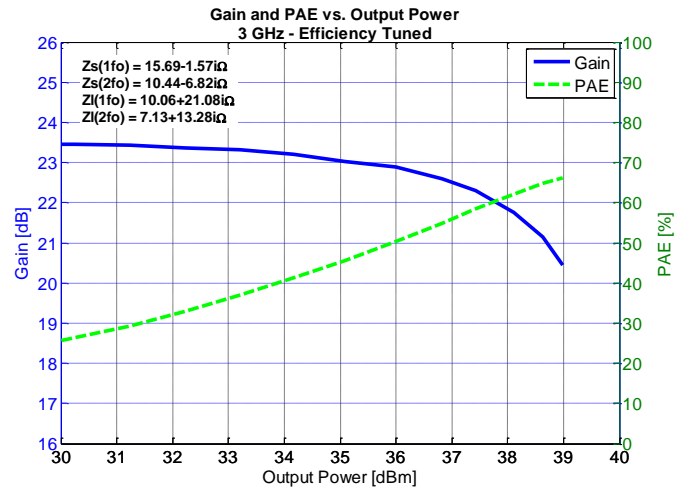
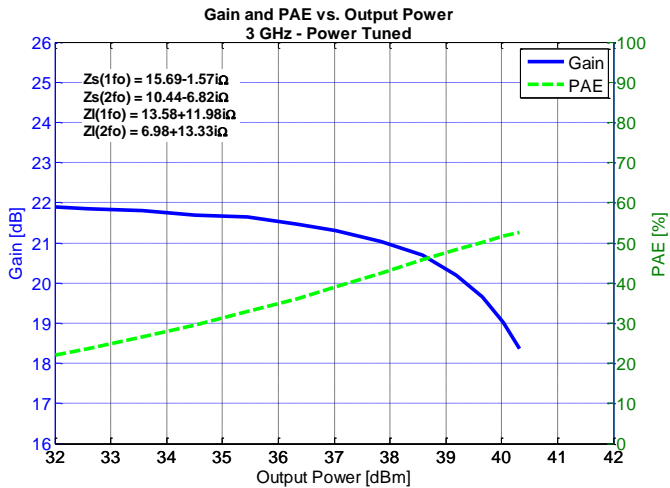
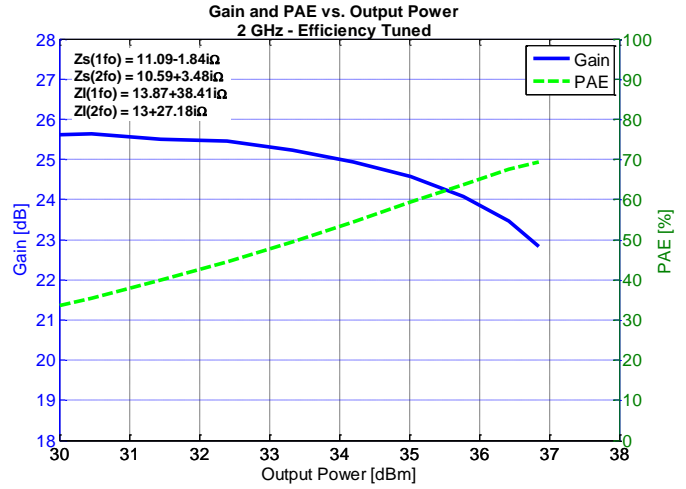
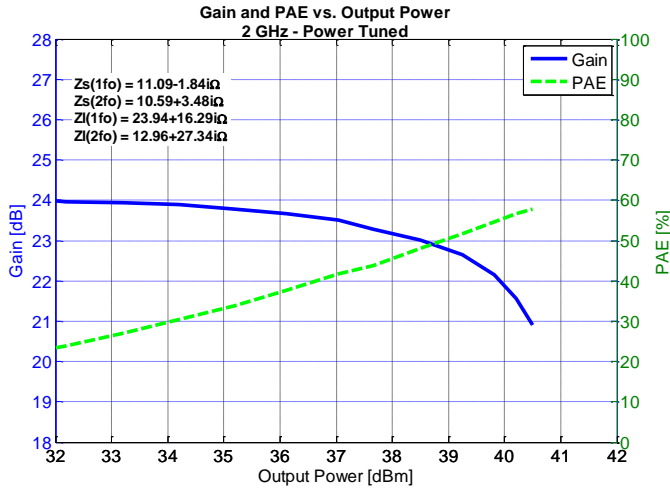

Typical Performance – Load Pull Drive-up^{1, 2}

Notes:

1. Pulsed signal with 100 us pulse width and 20 % duty cycle, $V_d = 32\text{ V}$, $I_{DQ} = 50\text{ mA}$
2. See page 17 for load pull and source pull reference planes where the performance was measured.

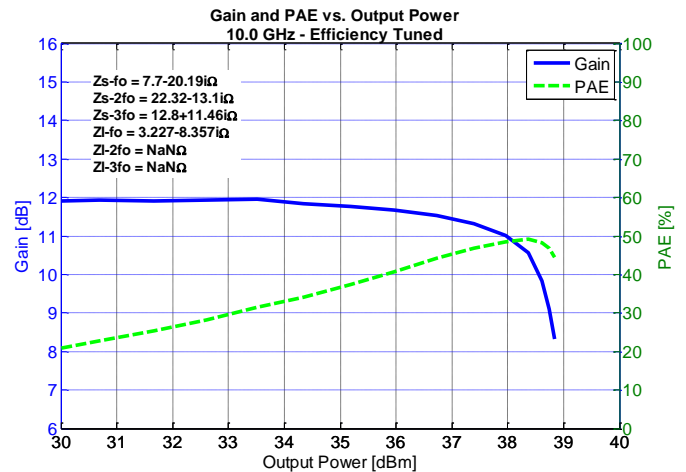
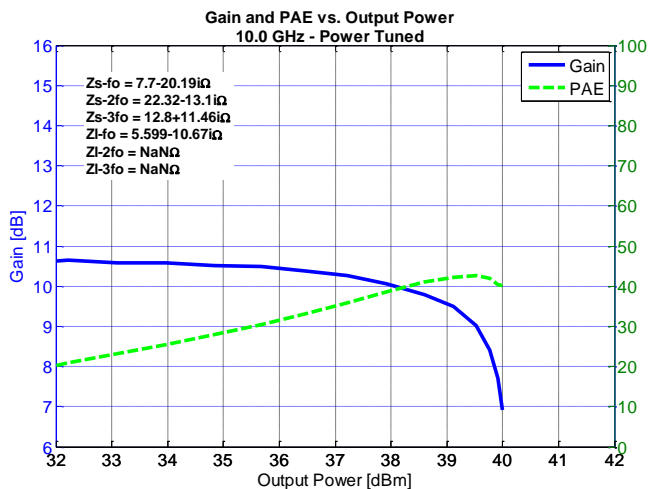
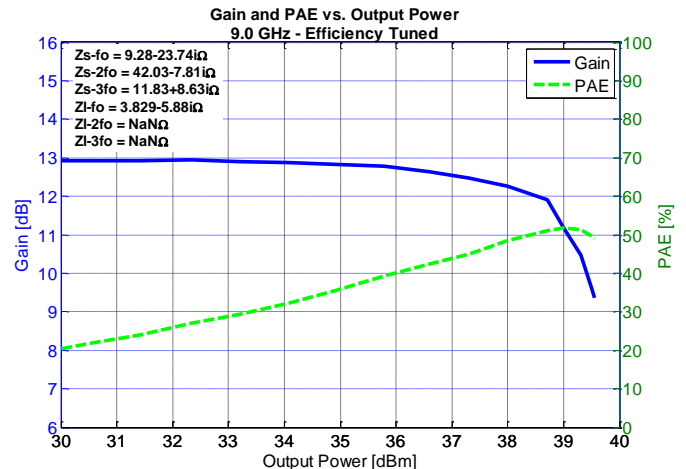
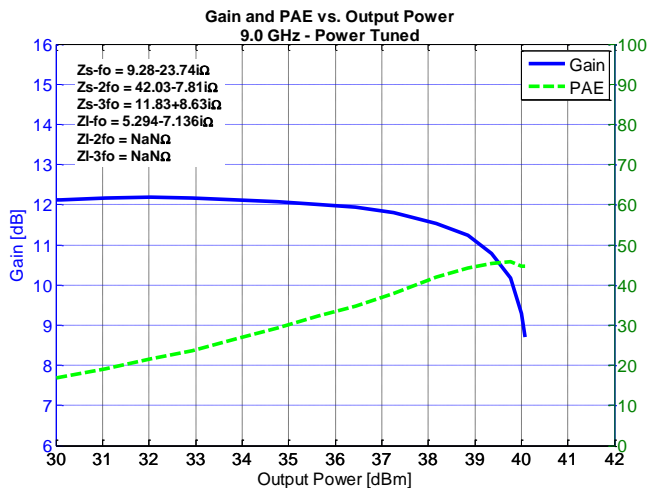
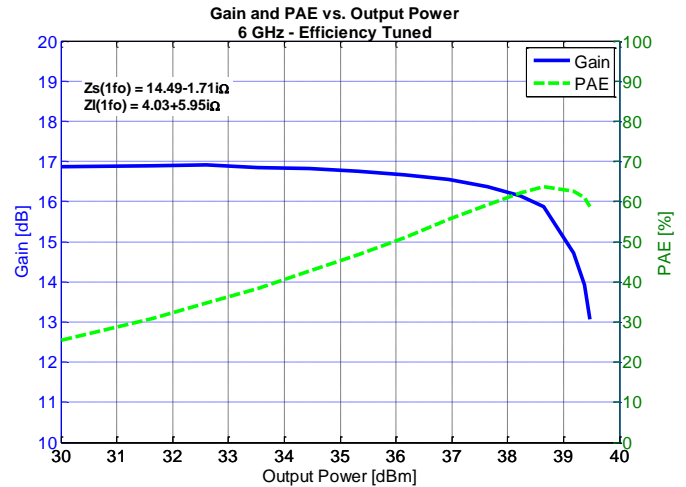
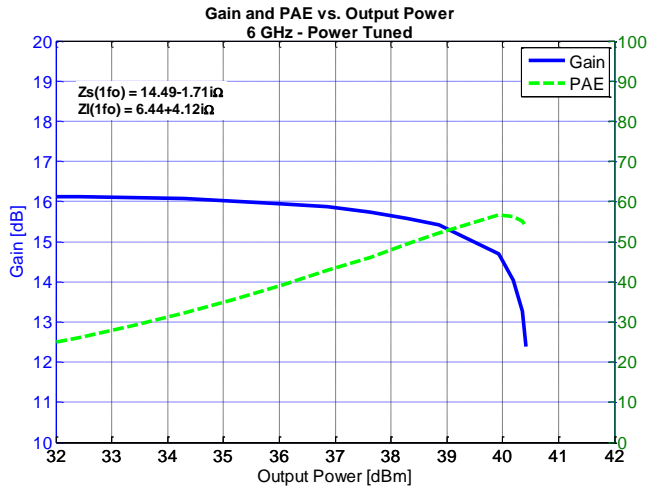

Power Driveup Performance Over Temperatures of 3.1 – 3.5 GHz EVB¹

Notes:

1- $V_d = 32\text{ V}$, $I_{bQ} = 50\text{ mA}$, Pulse Width = 100 us, Duty Cycle = 20 %

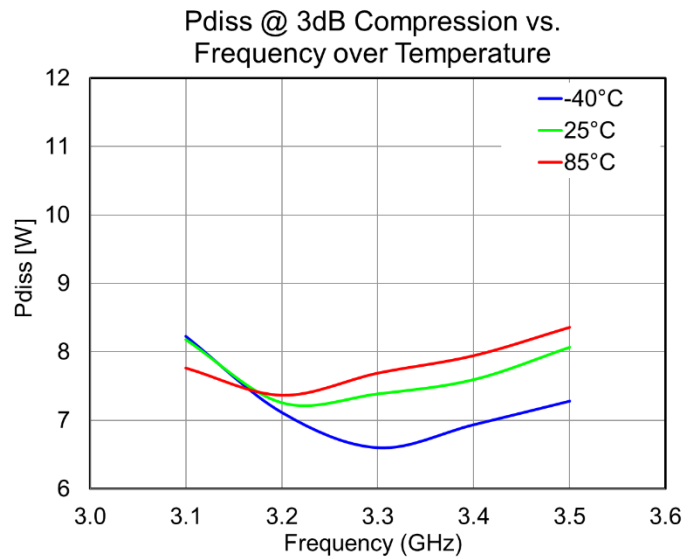
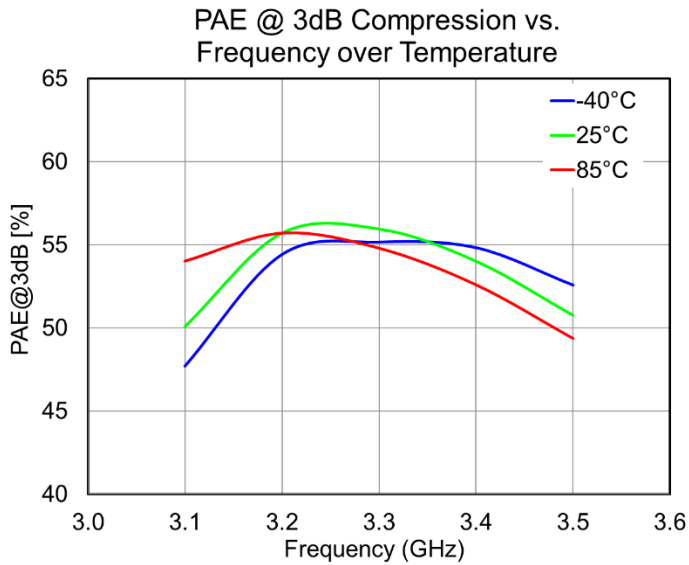
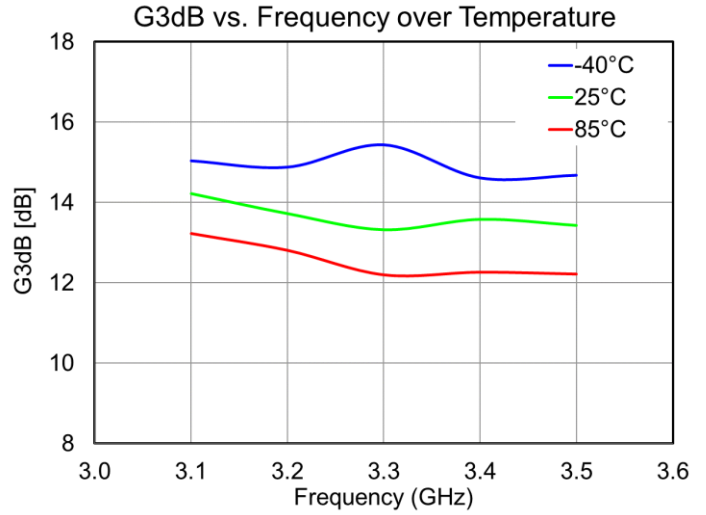
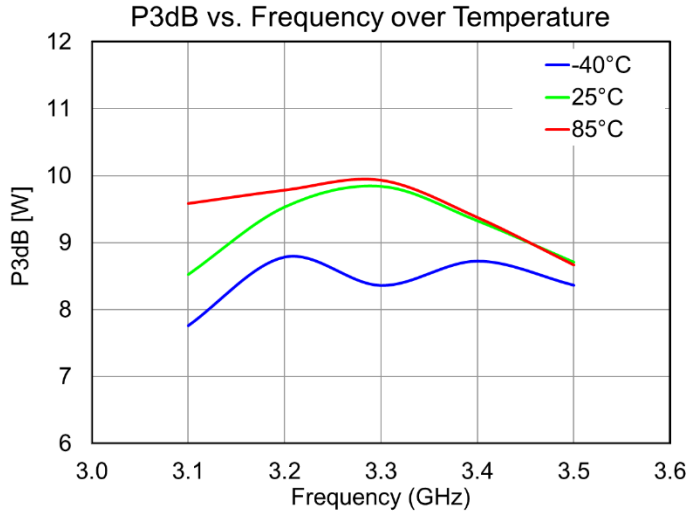

Power Driveup Performance at 25 °C of 3.1 – 3.5 GHz EVB¹

Notes:

1- $V_d = 32\text{ V}$, $I_{bq} = 50\text{ mA}$, Pulse Width = 100 us, Duty Cycle = 20 %

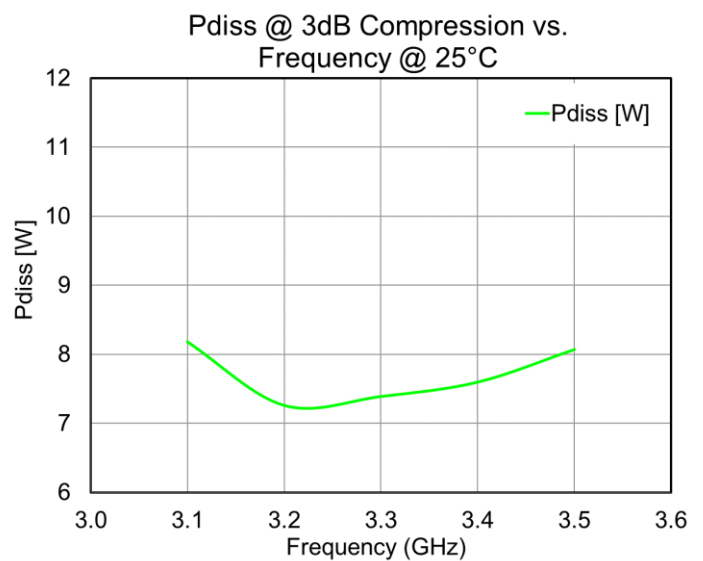
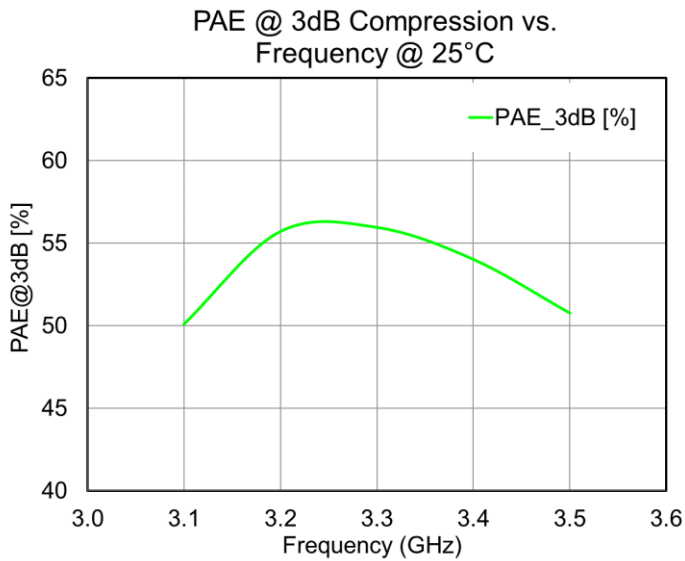
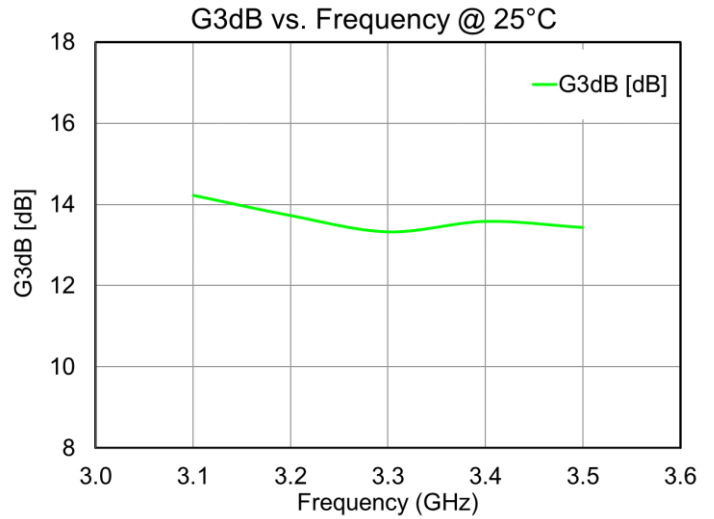
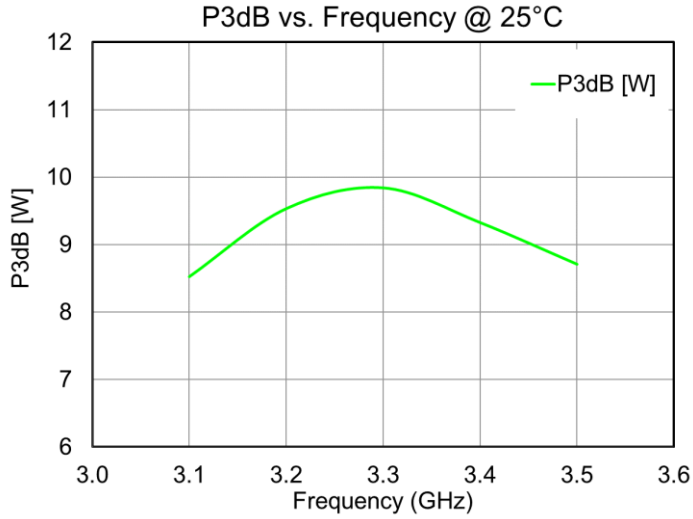

Two-Tone Performance at 25 °C of 3.1 – 3.5 GHz EVB¹

Notes:

- 1- Center Frequency = 3.3 GHz. Tone Separation = 10 MHz.

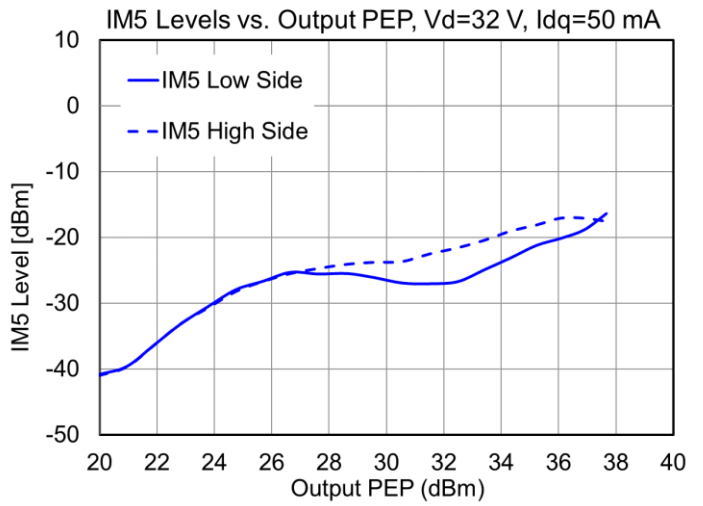
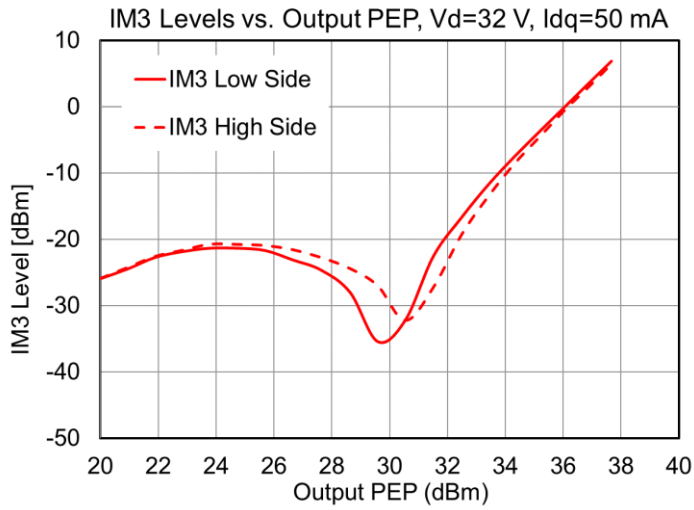

Pin Layout¹

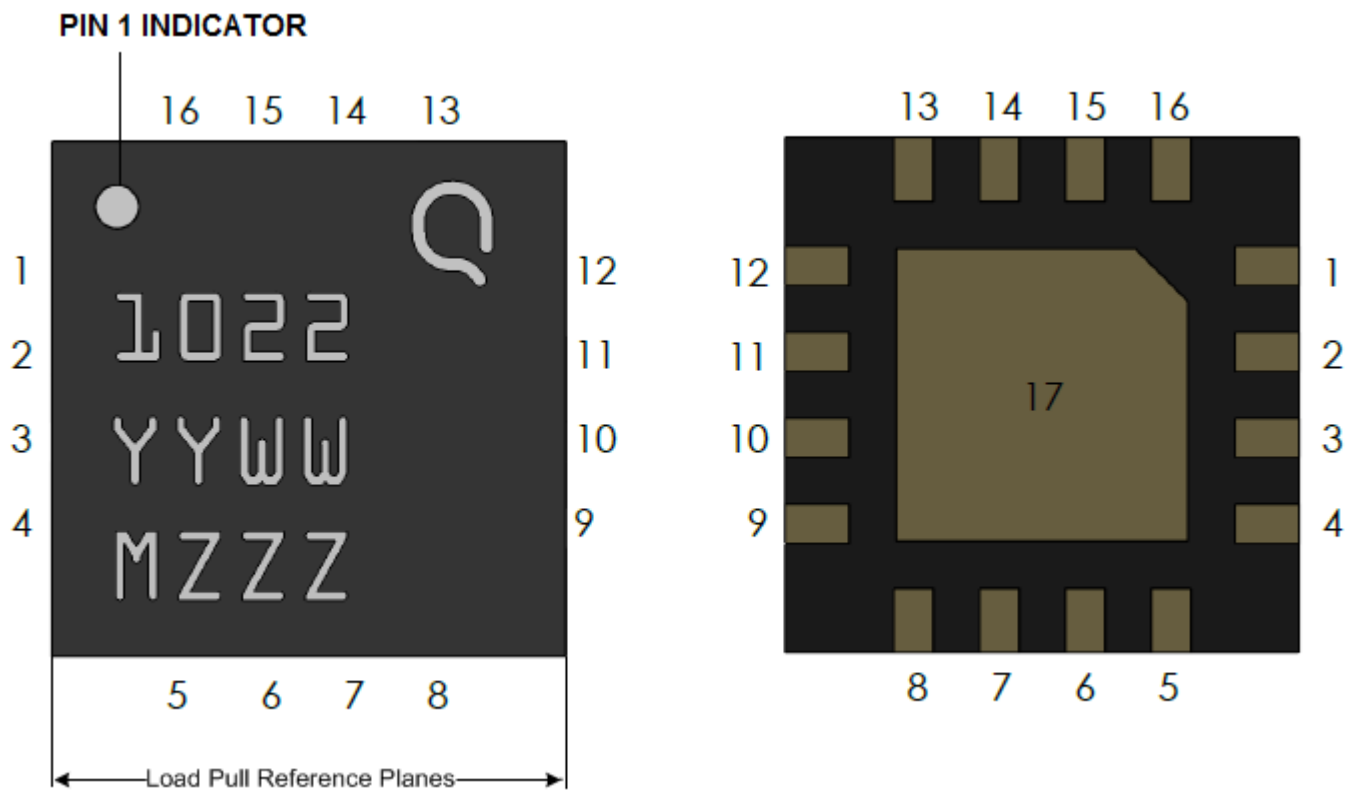

Notes:

1. The QPD1022 will be marked with the "1022" designator and a lot code marked below the part designator. The "YY" represents the last two digits of the calendar year the part was manufactured, the "WW" is the work week of the assembly lot start, the "MZZZ" is the batch ID.

Pin Description

Pin	Symbol	Description
2, 3	VG / RF IN	Gate voltage / RF Input
9 – 12	VD / RF OUT	Drain voltage / RF Output
1, 4, 5 – 8, 13 – 16	NC	Not Connected
17	Back Plane	Source to be connected to ground

Mechanical Drawing¹

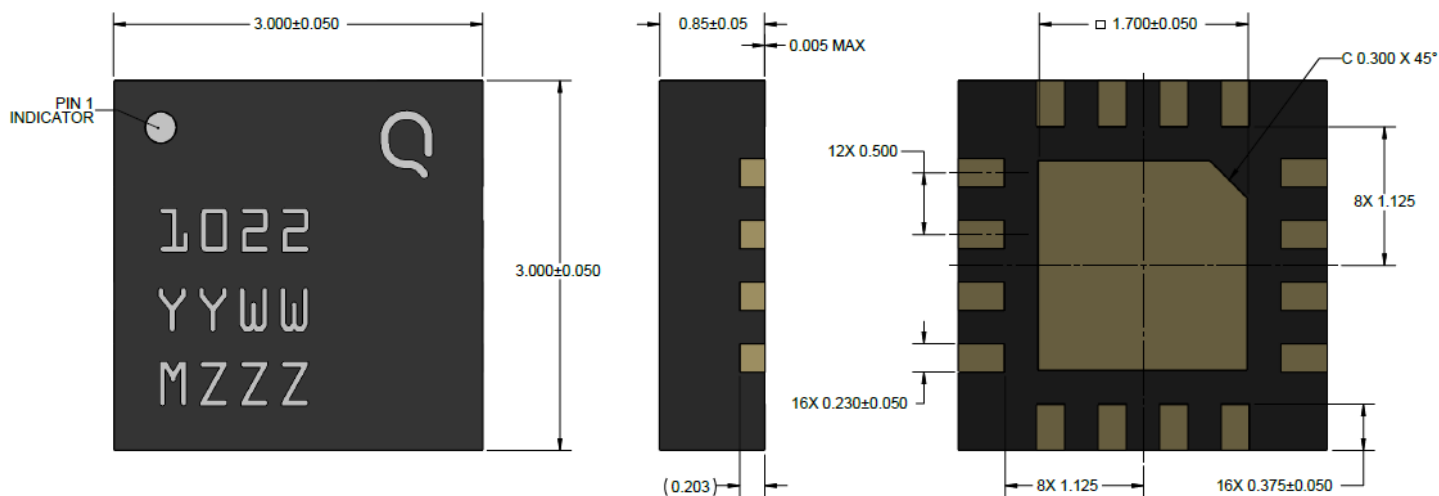

Notes:

1- All dimensions are in mm, otherwise noted. Tolerance is ± 0.050 mm.

Bias-up Procedure	Bias-down Procedure
1. Set V_G to -4 V.	1. Turn off RF signal.
2. Set ID current limit to 100 mA.	2. Turn off VD
3. Apply 32 V VD.	3. Wait 2 seconds to allow drain capacitor to discharge
4. Slowly adjust VG until ID is set to 50 mA.	4. Turn off VG
5. Set ID current limit to 1 A	
6. Apply RF.	

PCB Layout – 3.1 – 3.5 GHz EVB¹

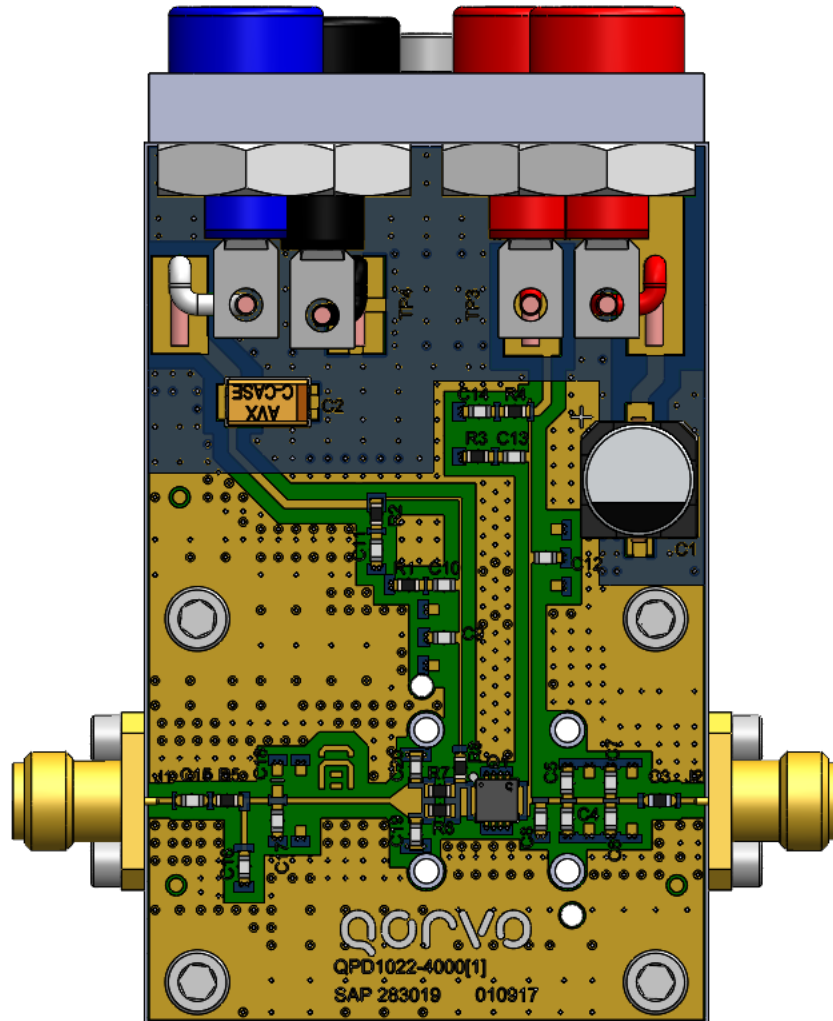

Notes:

- 1- PCB Material is RO4003, 8 mil thick substrate, 1 oz. copper each side.

Bill Of material – 3.1 – 3.5 GHz EVB

Ref Des	Value	Description	Manufacturer	Part Number
C10, C13	100 pF	COG 100V 5% 0603 Capacitor	TDK	C1608C0G2E101JT080AA
C11, C14	1 nF	X7R 100V 10% 0603 Capacitor	AVX	06031C102KAT2A
C6 – C8	1.0 pF	RF NPO 250VDC ± 0.05 pF Capacitor	ATC	600S1R0AT250X
C9, C12	9.1 pF	RF NPO 250VDC ± 0.1 pF Capacitor	ATC	600S9R1BT250X
C16	10 pF	RF NPO 250VDC 1% Capacitor	ATC	600S100FT250X
C17	0.2 pF	RF NPO 250VDC ± 0.05 pF Capacitor	ATC	600S0R3AT250X
C15	0.6 pF	RF NPO 250VDC ± 0.05 pF Capacitor	ATC	600S0R6AT250X
C19 – C20	0.8 pF	RF NPO 250VDC ± 0.05 pF Capacitor	ATC	600S0R8AT250X
C4 – C5	2.2 pF	RF NPO 250VDC ± 0.05 pF Capacitor	ATC	600S2R2AT250X
C3	5.6pF	RF NPO 250VDC ± 0.1 pF Capacitor	ATC	600S5R6BT250X
C1	33 uF	80V 20% SVP Capacitor	Panasonic	EEEFK1K330P
C2	10 uF	16V 10% Tantalum Capacitor	AVX	TPSC106KR0500
J1 – J2	–	SMA Panel Mount 4-hole Jack	Gigalane	PSF-S00-000
R5	0 Ohm	0603 5% Thick Film Resistor	ANY	–
R6 – R7	5.1 Ohm	0603 1% Thick Film Resistor	ANY	–
R8	10 Ohm	0603 1% Thick Film Resistor	ANY	–
R1	22 Ohm	0603 5% Thick Film Resistor	ANY	–
R3	5.6 Ohm	0603 5% Thick Film Resistor	ANY	–
R2, R4	33 Ohm	0603 1% Thick Film Resistor	ANY	–

Recommended Solder Temperature Profile

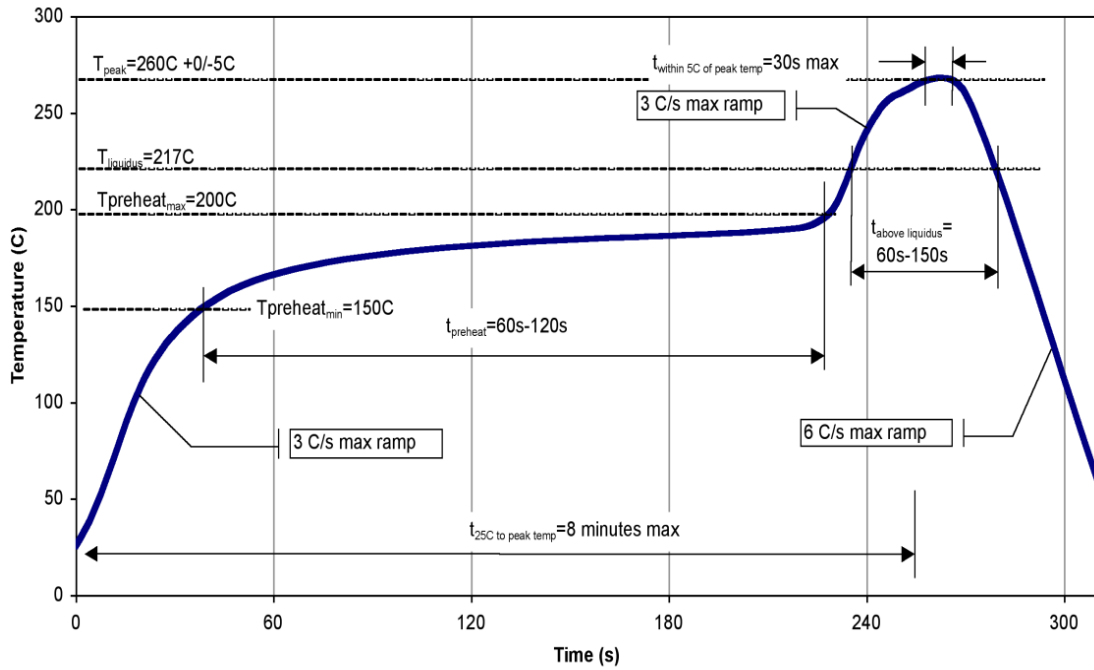

Handling Precautions

Parameter	Rating	Standard
ESD – Human Body Model (HBM)	Class 1A	ANSI / ESDA / JEDEC JS-001
ESD – Charged Device Model (CDM)	Class C3	ANSI / ESDA / JEDEC JS-002
MSL – Moisture Sensitivity Level	MSL3	IPC / JEDEC J-STD-020



Caution!
ESD-Sensitive Device

Solderability

Compatible with both lead-free (260°C max. reflow temp.) and tin/lead (245°C max. reflow temp.) soldering processes. Solder profiles available upon request.

Contact plating: NiPdAu Au thickness is 0.00254µm min.

RoHS Compliance

This part is compliant with 2011/65/EU RoHS directive (Restrictions on the Use of Certain Hazardous Substances in Electrical and Electronic Equipment) as amended by Directive 2015/863/EU.

This product also has the following attributes:

- Lead Free
- Antimony Free
- TBBP-A (C₁₅H₁₂Br₄O₂) Free
- PFOS Free
- SVHC Free

Contact Information

For the latest specifications, additional product information, worldwide sales and distribution locations, and information about Qorvo:

Web: www.Qorvo.com Tel: +1.844.890.8163
 Email: customer.support@qorvo.com

For technical questions and application information: Email: info-products@qorvo.com

Important Notice

The information contained herein is believed to be reliable; however, Qorvo makes no warranties regarding the information contained herein and assumes no responsibility or liability whatsoever for the use of the information contained herein. All information contained herein is subject to change without notice. Customers should obtain and verify the latest relevant information before placing orders for Qorvo products. The information contained herein or any use of such information does not grant, explicitly or implicitly, to any party any patent rights, licenses, or any other intellectual property rights, whether with regard to such information itself or anything described by such information. **THIS INFORMATION DOES NOT CONSTITUTE A WARRANTY WITH RESPECT TO THE PRODUCTS DESCRIBED HEREIN, AND QORVO HEREBY DISCLAIMS ANY AND ALL WARRANTIES WITH RESPECT TO SUCH PRODUCTS WHETHER EXPRESS OR IMPLIED BY LAW, COURSE OF DEALING, COURSE OF PERFORMANCE, USAGE OF TRADE OR OTHERWISE, INCLUDING THE IMPLIED WARRANTIES OF MERCHANTABILITY AND FITNESS FOR A PARTICULAR PURPOSE.**

Without limiting the generality of the foregoing, Qorvo products are not warranted or authorized for use as critical components in medical, life-saving, or life-sustaining applications, or other applications where a failure would reasonably be expected to cause severe personal injury or death.

Copyright 2018 © Qorvo, Inc. | Qorvo is a registered trademark of Qorvo, Inc.

Mouser Electronics

Authorized Distributor

Click to View Pricing, Inventory, Delivery & Lifecycle Information:

[Qorvo:](#)

[QPD1022SR](#) [QPD1022EVB01](#) [QPD1022](#)