

Product Overview

The CMD272P3 is a low loss broadband positive control MMIC DPDT transfer switch housed in a leadless 3x3 mm surface mount package. The CMD272P3 covers DC to 10 GHz and offers a low insertion loss of 1.6 dB and high isolation of 43 dB at 5 GHz. The CMD272P3 operates using complementary control voltage logic lines of 0/+5 V.

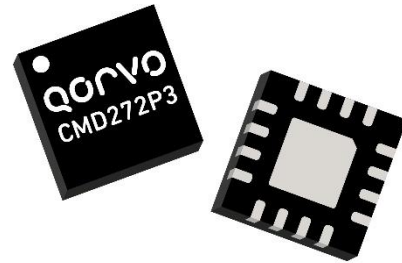

Functional Block Diagram

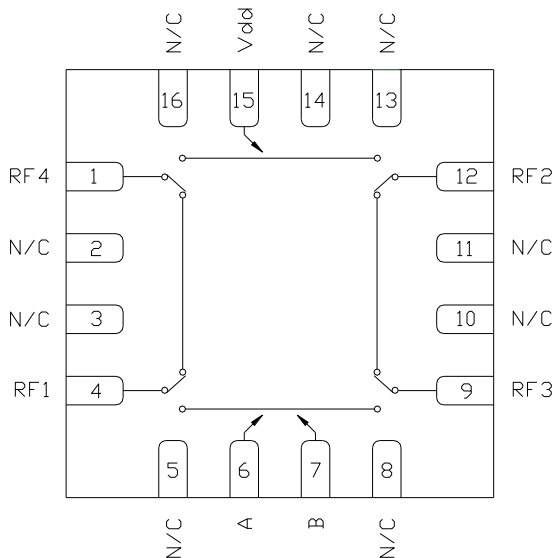

Key Features

- Low Loss Broadband Performance
- High Isolation
- Non-Reflective Design
- Pb-Free RoHs Compliant 3x3 SMT Package

Ordering Information

Part No.	Description
CMD272P3	100 Piece 7" Reel
CMD272P3-EVB	1 Piece Bag

Electrical Performance ($V_{ctl} = 0/+5\text{ V}$, $V_{dd} = +5\text{ V}$, $T_A = 25^\circ\text{ C}$, $F = 5\text{ GHz}$)

Parameter	Min	Typ	Max	Units
Frequency Range		DC - 10		GHz
Insertion Loss		1.6		dB
Isolation		43		dB
Return Loss		13		dB
Input P0.1dB		25		dBm
Input IP3		38		dBm
Switching Speed		10		ns

Absolute Maximum Ratings

Parameter	Rating
RF Input Power	+27 dBm
Bias Voltage (V_{dd})	+7.0V
Control Voltage Range (A, B)	-0.5V to $V_{dd} + 1V$
Channel Temperature, T_{ch}	150° C
Thermal Resistance, Q_{JC}	34.5° C/W
Operating Temperature	-40 to 85° C
Storage Temperature	-55 to 150° C

Exceeding any one or combination of the maximum ratings may cause permanent damage to the device.

Bias Voltage & Current

V_{dd} Range = +5.0V ± 10%		
V_{dd} (V)	I_{dd} (Typ) (uA)	I_{dd} (Max) (uA)
+5	5	10

TTL/CMOS Control Voltages

State	Bias Condition
Low	0V to +0.2V @ 1 uA Typ
High	$V_{dd} \pm 0.2V$ @ 1 uA Typ

Truth Table

Control Input					
A	B	RF4 to RF2	RF1 to RF3	RF4 to RF1	RF2 to RF3
Low	High	On	On	Off	Off
High	Low	Off	Off	On	On

Electrical Specifications ($V_{ctl} = 0/+5 V$, $V_{dd} = +5 V$ $T_A = 25^\circ C$)

Parameter	Min	Typ	Max	Min	Typ	Max	Min	Typ	Max	Units
Frequency Range	DC - 4			DC - 8			DC - 10			GHz
Insertion Loss		1.2	1.8		1.5	2.1		1.6	2.4	dB
Isolation	37	44		32	40		28	35		dB
Return Loss		15			13			11		dB
Input P0.1dB		24			24			24		dBm
Input IP3		38			38			38		dBm
Switching Speed		10			10			10		ns

Typical Performance

Insertion Loss vs. Temperature

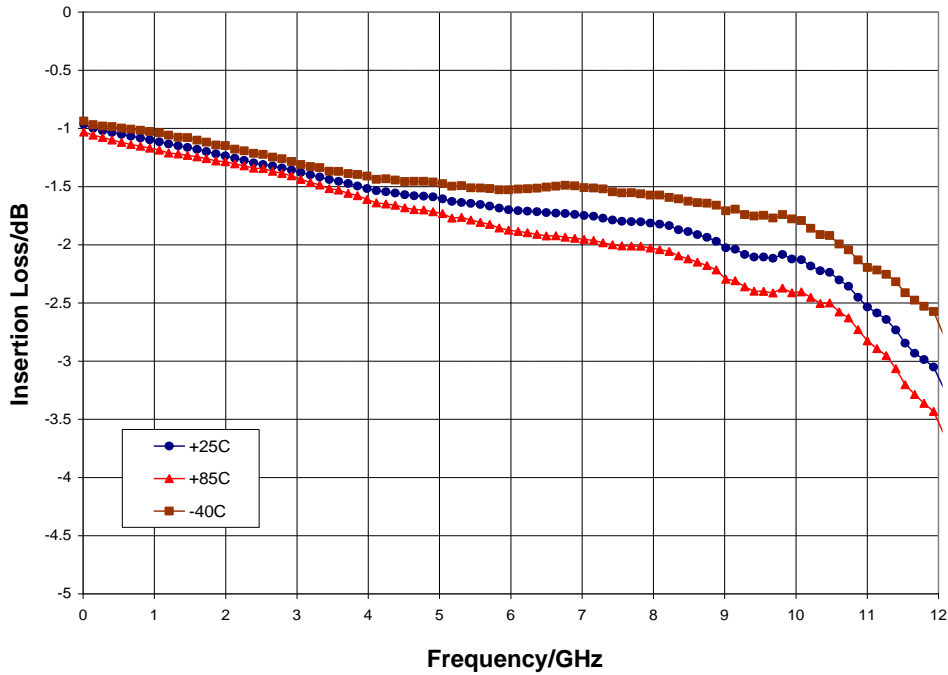

Return Loss

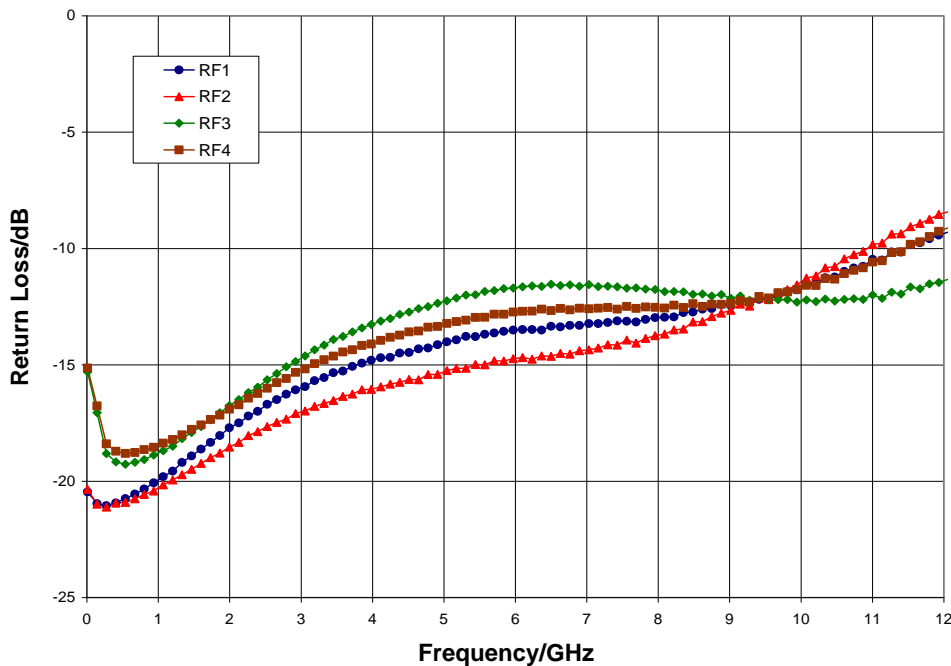

Typical Performance

Isolation

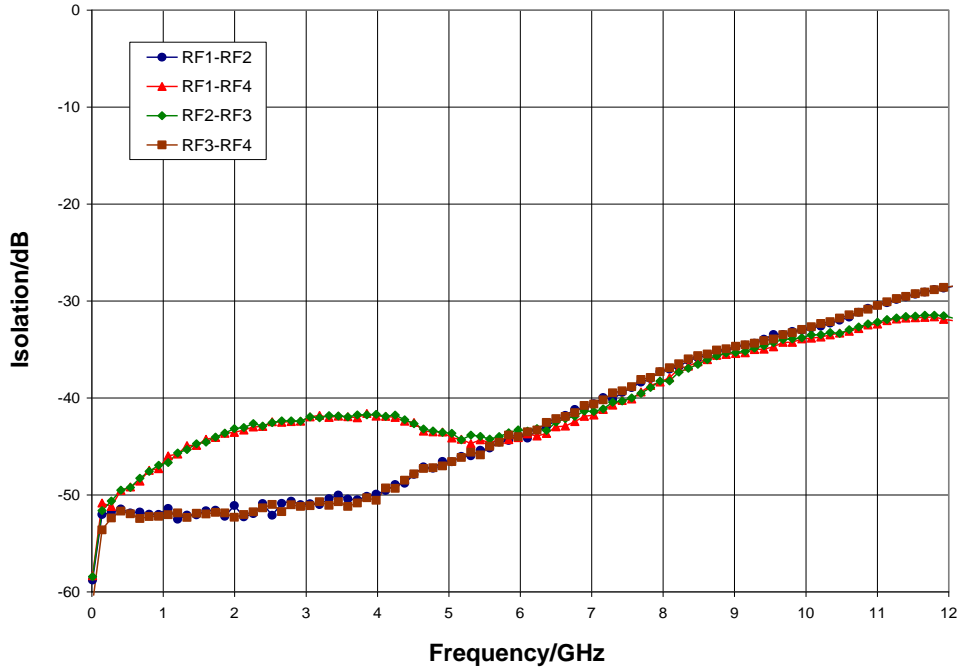

Input P0.1dB Compression Point vs. Temperature

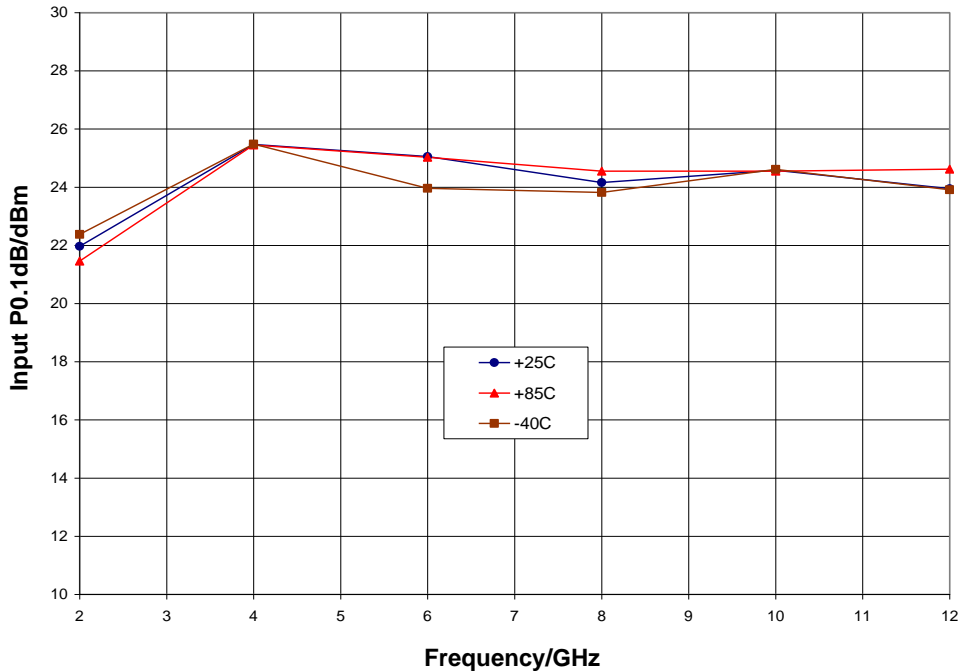

Typical Performance

Input Third Order Intercept Point vs. Temperature

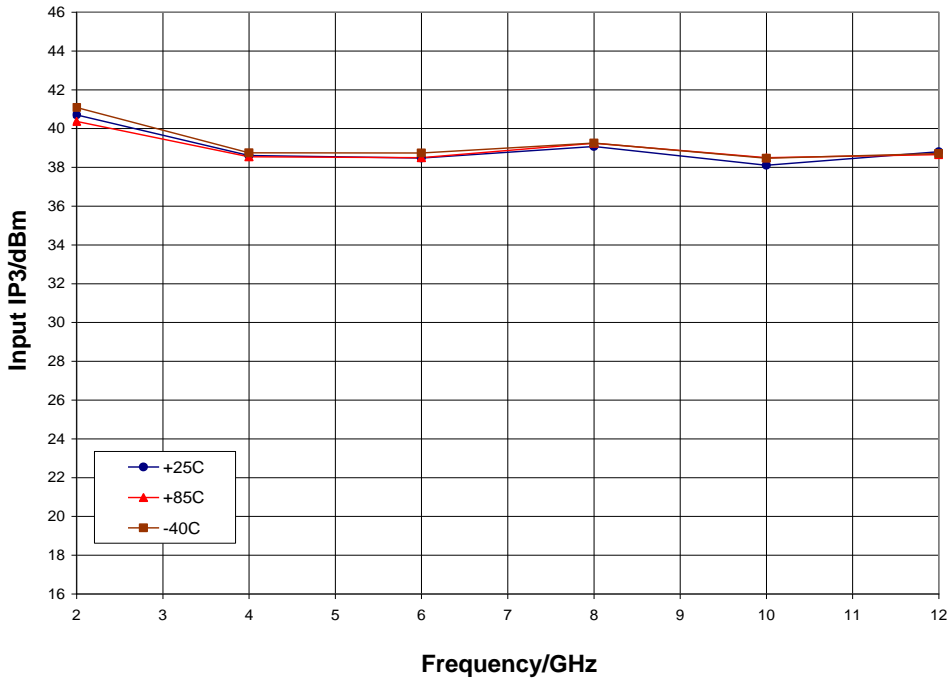

Mechanical Information

Package Information and Dimensions

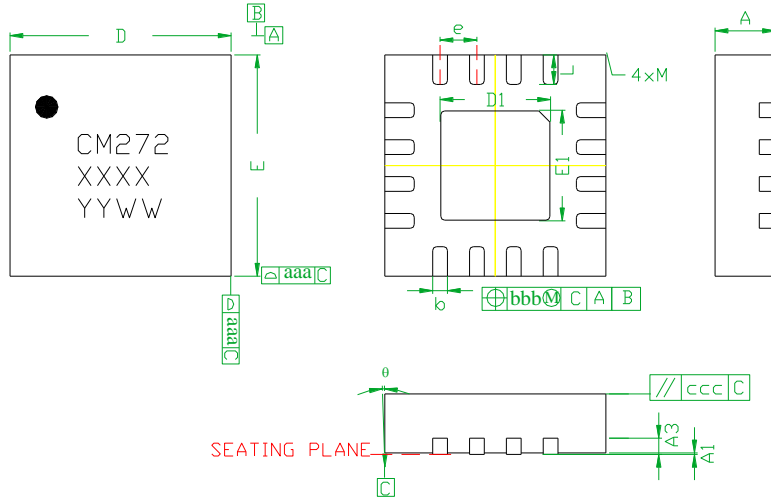

SYMBOLS	DIMENSIONS IN MILLIMETERS		
	MIN	NOM	MAX
A	0.80	0.90	1.00
A1	0	0.02	0.05
A3	---	0.25REF.	---
b	0.18	0.23	0.30
D	2.85	3.00	3.15
D1	---	1.5BSC	---
E	2.85	3.00	3.15
E1	---	1.5BSC	---
e	---	0.50BSC	---
L	0.30	0.40	0.50
θ	0	---	12
aaa	---	0.25	---
bbb	---	0.10	---
ccc	---	0.10	---
M	---	---	0.05

Notes:

1. Dimensions are in millimeters
2. RoHs compliant mold compound
3. Lead frame material: Copper alloy
4. Lead finish: 100% matte Sn
5. Indicated dimension/tolerance applies to leads and exposed pads

Recommended PCB Land Pattern

Qorvo recommends that the user develop the land pattern that will provide the best design for proper solder reflow and device attach for their specific application. Please review Qorvo Application Note AN 105 for a recommended land pattern approach.

Recommended Solder Reflow Profile

Qorvo recommends screen printing with belt furnace reflow to ensure proper solder reflow and device attach. Please review Qorvo Application Note AN 102 for a recommended solder reflow profile.

Pin Description

Pin Diagram

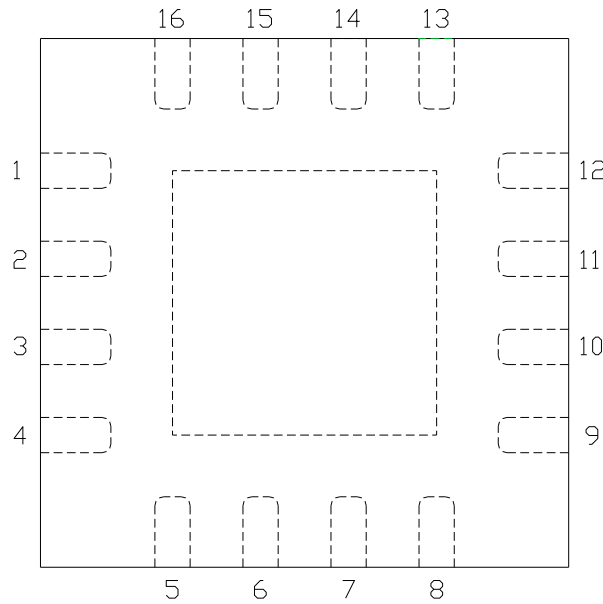

Functional Description

Pin	Function	Description	Schematic
1, 4, 9, 12	RF4, RF1, RF3, RF2	These pins are DC coupled and matched to 50 ohm Blocking capacitors are required	
15	V _{dd}	Power supply voltage	
6	CTLA	See truth table and control voltage table	
7	CTLB	See truth table and control voltage table	
2, 3, 5, 8, 10, 11, 13, 14, 16	N/C	No connection required These pins may be connected to RF / DC ground	
Die paddle	Ground	Connect to RF / DC ground	

Applications Information

Evaluation Board

The circuit board shown has been developed for optimized assembly at Qorvo. A sufficient number of via holes should be used to connect the top and bottom ground planes. As surface mount processes vary, careful process development is recommended.

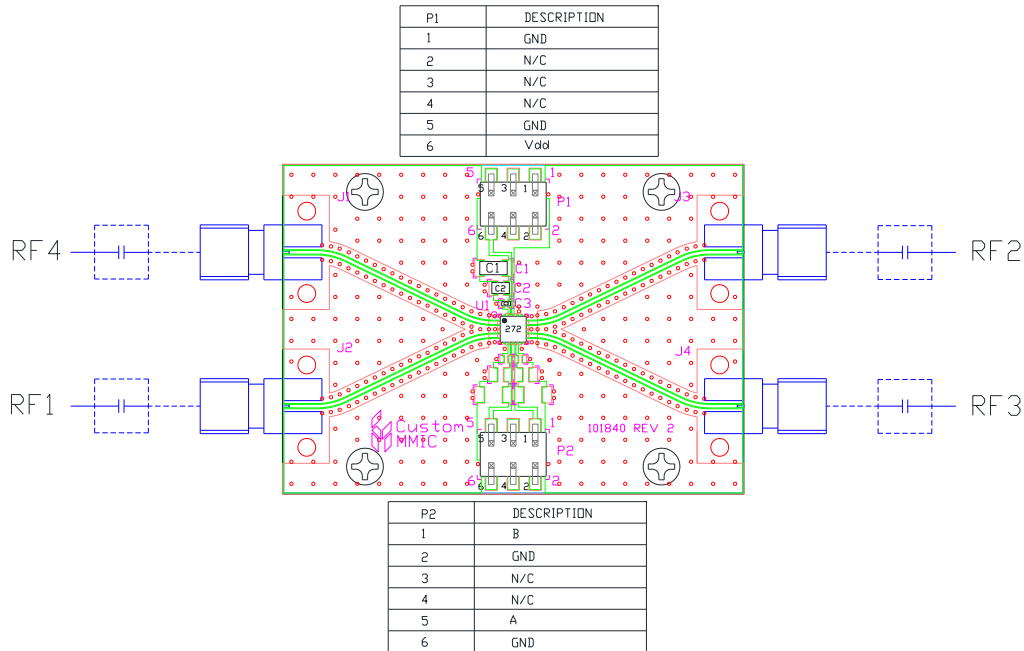

Bill of Material

Designator	Value	Description
J1 - J4		SMA End Launch Connector
P1, P2		6 Pin Header
C1	0.33 μ F	Capacitor, Tantalum
C2	1000 pF	Capacitor, 0603
C3	100 pF	Capacitor, 0402
U1		CMD272P3 DPDT Transfer Switch
PCB		101840 Evaluation PCB

GaAs MMIC devices are susceptible to damage from Electrostatic Discharge. Proper precautions should be observed during handling, assembly and test.

Handling Precautions

Parameter	Rating	Standard
ESD – Human Body Model (HBM)	Class 1A	ESDA / JEDEC JS-001-2012
MSL – Moisture Sensitivity Level	Level 1	JEDEC standard IPC/JEDEC J-STD-020



Caution!
 ESD-Sensitive Device

RoHS Compliance

This part is compliant with 2011/65/EU RoHS directive (Restrictions on the Use of Certain Hazardous Substances in Electrical and Electronic Equipment) as amended by Directive 2015/863/EU.

This product also has the following attributes:

- Lead Free
- Antimony Free
- TBBP-A (C₁₅H₁₂Br₄O₂) Free
- SVHC Free
- Halogen Free
- PFOS Free

Contact Information

For the latest specifications, additional product information, worldwide sales and distribution locations:

Web: www.gorvo.com

Tel: 1-844-890-8163

Email: customer.support@gorvo.com

Important Notice

The information contained in this Data Sheet and any associated documents (“Data Sheet Information”) is believed to be reliable; however, Qorvo makes no warranties regarding the Data Sheet Information and assumes no responsibility or liability whatsoever for the use of said information. All Data Sheet Information is subject to change without notice. Customers should obtain and verify the latest relevant Data Sheet Information before placing orders for Qorvo® products. Data Sheet Information or the use thereof does not grant, explicitly, implicitly or otherwise any rights or licenses to any third party with respect to patents or any other intellectual property whether with regard to such Data Sheet Information itself or anything described by such information.

DATA SHEET INFORMATION DOES NOT CONSTITUTE A WARRANTY WITH RESPECT TO THE PRODUCTS DESCRIBED HEREIN, AND QORVO HEREBY DISCLAIMS ANY AND ALL WARRANTIES WITH RESPECT TO SUCH PRODUCTS WHETHER EXPRESS OR IMPLIED BY LAW, COURSE OF DEALING, COURSE OF PERFORMANCE, USAGE OF TRADE OR OTHERWISE, INCLUDING THE IMPLIED WARRANTIES OF MERCHANTABILITY AND FITNESS FOR A PARTICULAR PURPOSE. Without limiting the generality of the foregoing, Qorvo® products are not warranted or authorized for use as critical components in medical, life-saving, or life-sustaining applications, or other applications where a failure would reasonably be expected to cause severe personal injury or death. Applications described in the Data Sheet Information are for illustrative purposes only. Customers are responsible for validating that a particular product described in the Data Sheet Information is suitable for use in a particular application.

© 2022 Qorvo US, Inc. All rights reserved. This document is subject to copyright laws in various jurisdictions worldwide and may not be reproduced or distributed, in whole or in part, without the express written consent of Qorvo US, Inc. | QORVO® is a registered trademark of Qorvo US, Inc.