



# QPA2609D

7 – 14 GHz Low Noise Amplifier

## Product Overview

Qorvo's QPA2609D is a high-performance, low noise MMIC amplifier fabricated on Qorvo's production 90 nm pHEMT process (QPHT09). Covering 7 – 14 GHz, the QPA2609D provides 27 dB small signal gain and 1.1 dB noise figure. With a compact size of 2.37 x 0.97 mm, the amplifier can deliver 20dBm of saturated power with P1dB of 18 dBm. In addition, the device can provide low IMD3 level of -50 dBc at Pout = 0 dBm/tone.

The QPA2609D is matched to 50 ohms with integrated DC blocking caps on both I/O ports for easy handling and simple system integration.

The high performance of the QPA2609D makes it ideal for satellite and point to point communication systems.



## Key Features

- Frequency Range: 7 – 14 GHz
- Noise Figure: 1.1 dB (typical)
- Small Signal Gain: 27 dB (typical)
- P1dB: 18 dBm (typical)
- IMD3: -50 dBc (typical) (Pout=0 dBm/tone)
- Bias: VD = 3.5 V, IDQ = 120 mA, VG = -0.46 V (typical)
- Die Dimensions: 2.37 x 0.97 x 0.10 mm

## Applications

- Satellite Communications
- Point-to-Point Communications
- Radar

## Functional Block Diagram

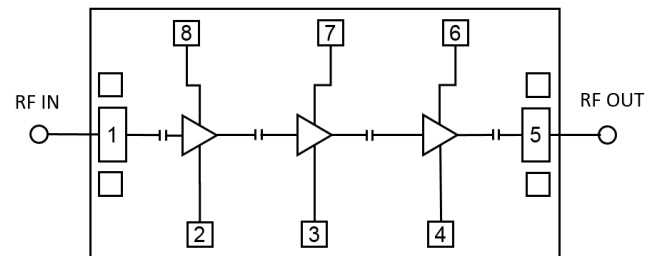

## Ordering Information

Part No.	Description
QPA2609D	7 – 14 GHz Low Noise Amplifier
QPA2609S	Space Inspected Version, Contact Sales
QPA2609DEVB1	QPA2609D Evaluation Board

## Absolute Maximum Ratings

Parameter	Rating	Units
Drain Voltage ( $V_D$ )	4.5	V
Drain Current ( $I_{D1}/I_{D2}/I_{D3}$ )	96/115/192	mA
Gate Voltage Range ( $V_G$ )	-1.3 to 0	V
Gate Current ( $I_{G1}/I_{G2}/I_{G3}$ at 125 °C)	5.0/5.0/6.6	mA
RF Input Power (50 $\Omega$ , 85 °C)	20	dBm
Channel Temperature, $T_{CH}$	175	°C
Mounting Temperature (30 seconds)	320	°C
Storage Temperature	-55 to 150	°C

Exceeding any one or a combination of the Absolute Maximum Rating conditions may cause permanent damage to the device. Extended application of Absolute Maximum Rating conditions to the device may reduce device reliability.

## Recommended Operating Conditions

Parameter	Value	Units
Drain Voltage	3.5	V
Drain Current (quiescent, $I_{DQ}$ )	120	mA
Drain Current ( $I_D$ , Low noise / $P_{SAT}$ )	120 / 175	mA
Gate Voltage (typical)	-0.46	V
Operating Temperature Range	-40 to 85	°C

Electrical specifications are measured at specified test conditions. Specifications are not guaranteed over all recommended operating conditions.

## Electrical Specifications

Test conditions unless otherwise noted:  $V_D = +3.5V$ ,  $I_{DQ} = 120$  mA, Temp. = +25 °C. Data de-embedded to MMIC bond wires.

Parameter	Min	Typ	Max	Units
Operating Frequency	7		14	GHz
Small Signal Gain		27		dB
Noise Figure		1.1		dB
1-dB Compression Point		18		dBm
Input Return Loss		14.0		dB
Output Return Loss		13.0		dB
3 <sup>RD</sup> Order Intermodulation Level ( $P_{OUT} = 0$ dBm / Tone)		-50		dBc
Output TOI ( $P_{out} = 0$ dBm / tone)		25.0		dBm
Gain (S21) Temperature Coefficient		-0.013		dB/°C

**Performance Plots – Small Signal**

Test conditions unless otherwise noted:  $V_D = +3.5V$ ,  $I_{DQ} = 120\text{ mA}$ , Temp. =  $+25\text{ }^\circ\text{C}$ . Data de-embedded to MMIC bond wires.

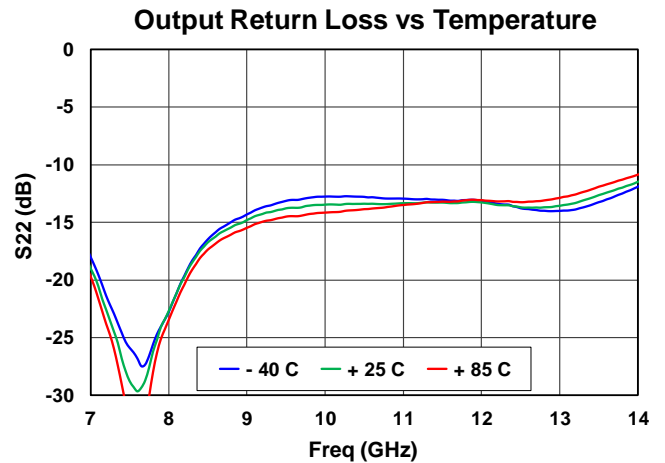
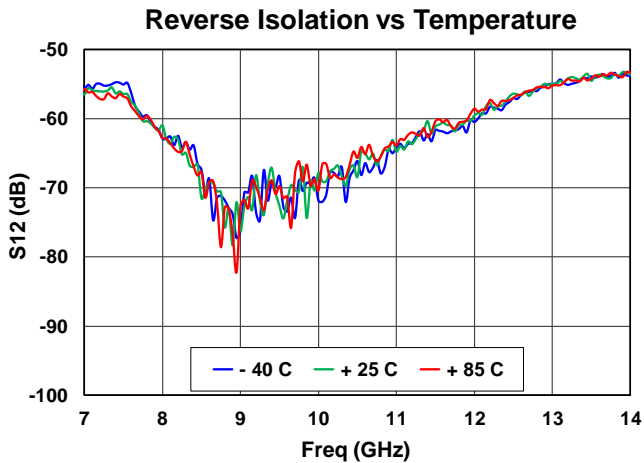
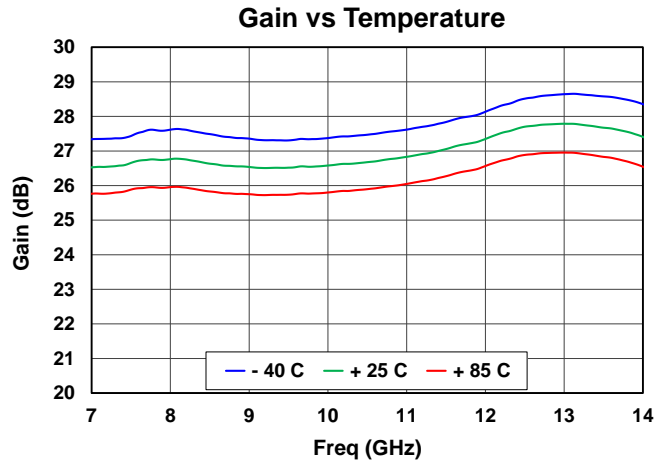
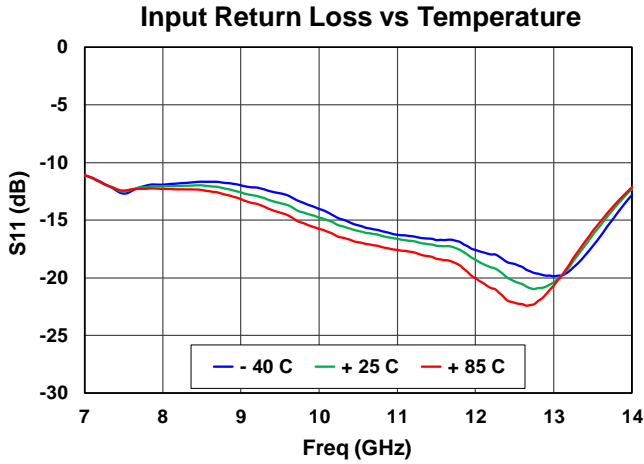

## Performance Plots – Small Signal

Test conditions unless otherwise noted:  $V_D = +3.5V$ ,  $I_{DQ} = 120\text{ mA}$ , Temp. =  $+25\text{ }^\circ\text{C}$ . Data de-embedded to MMIC bond wires.

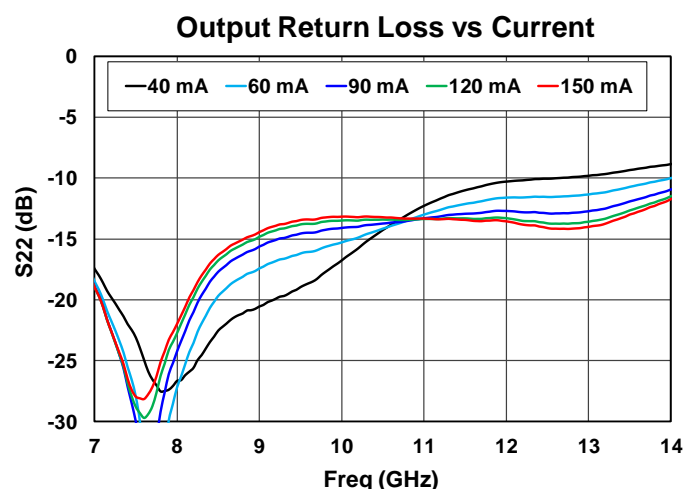
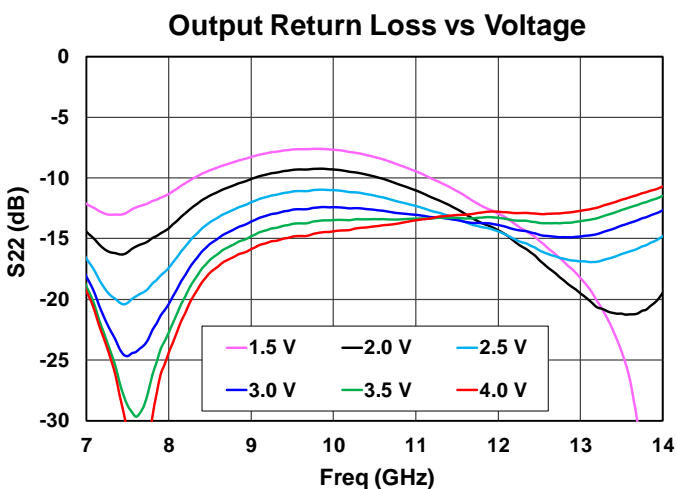
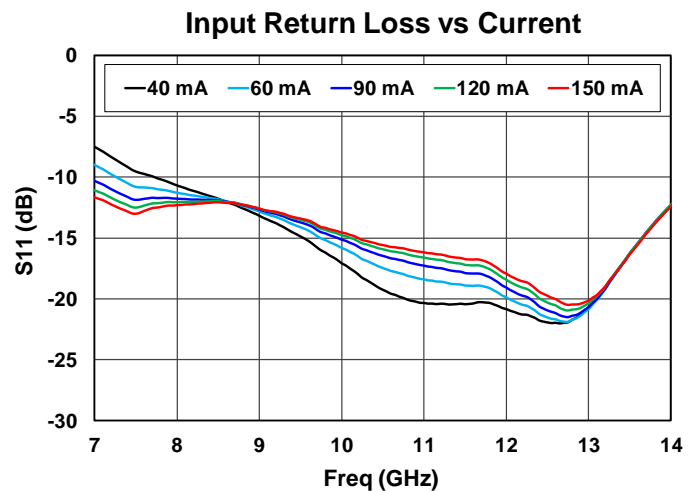
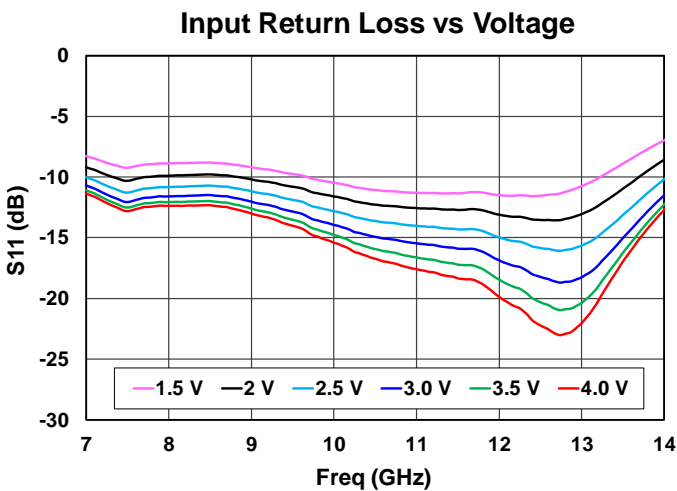
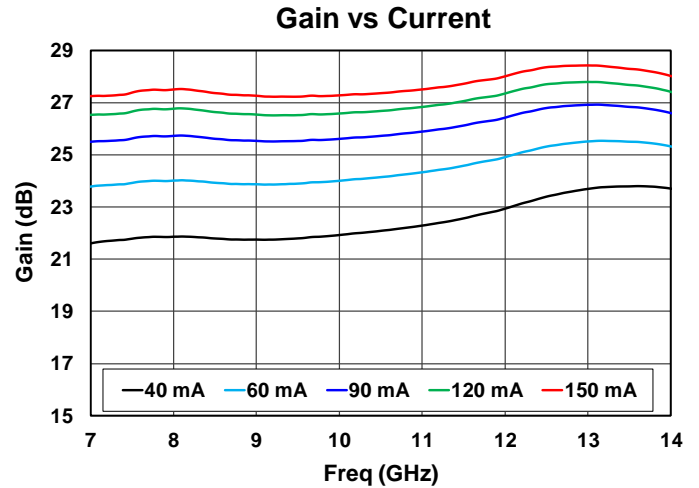
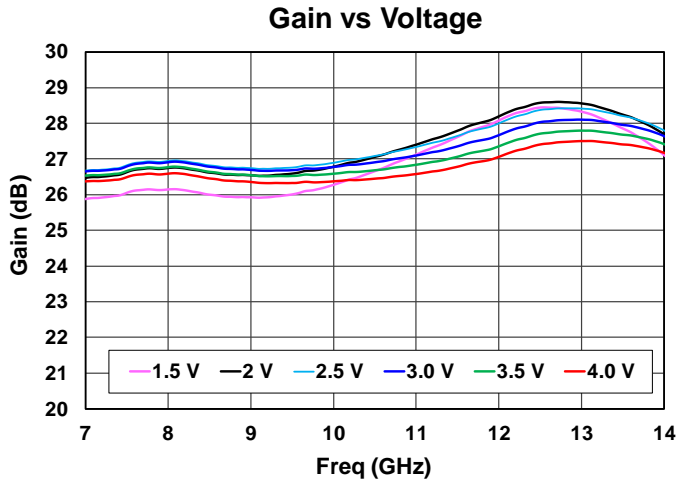

Performance Plots – Noise Figure

Test conditions unless otherwise noted:  $V_D = +3.5V$ ,  $I_{DQ} = 120\text{ mA}$ , Temp. =  $+25\text{ }^\circ\text{C}$ . Data de-embedded to MMIC bond wires.

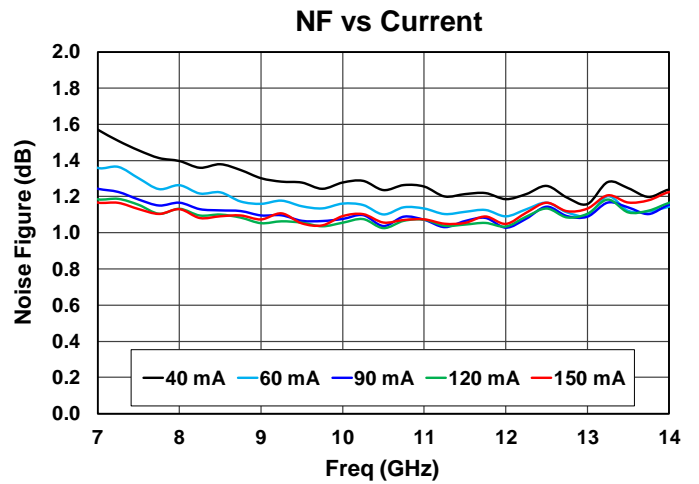
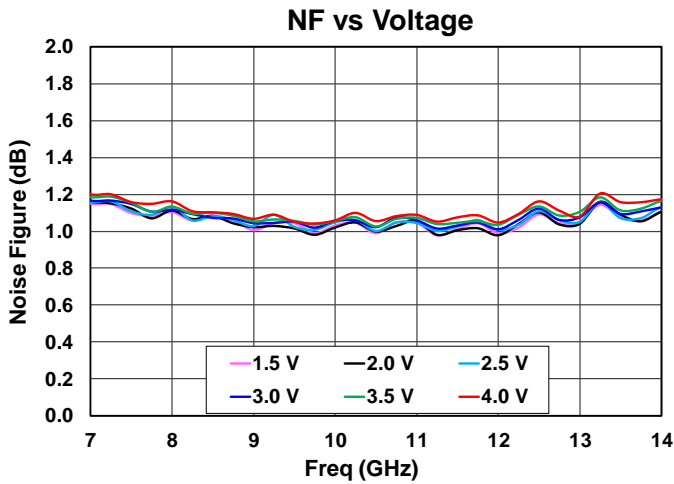
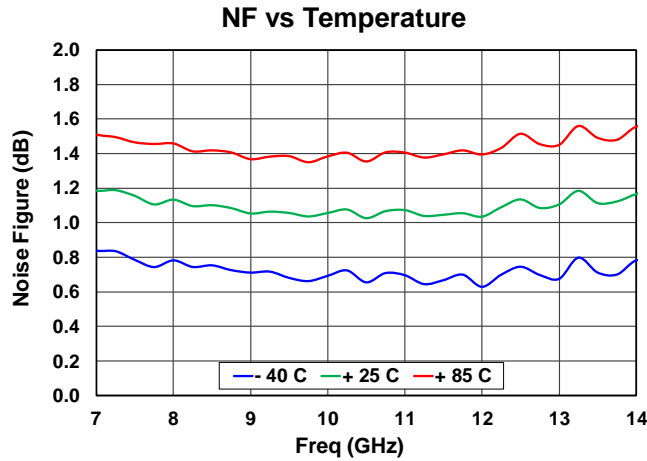

## Performance Plots – Large Signal

Test conditions unless otherwise noted:  $V_D = +3.5V$ ,  $I_{DQ} = 120\text{ mA}$ , Temp. =  $+25\text{ }^\circ\text{C}$ . Data de-embedded to MMIC bond wires.

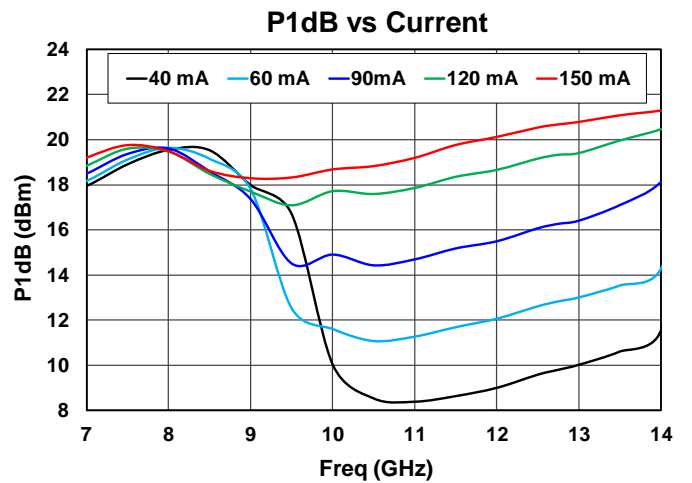
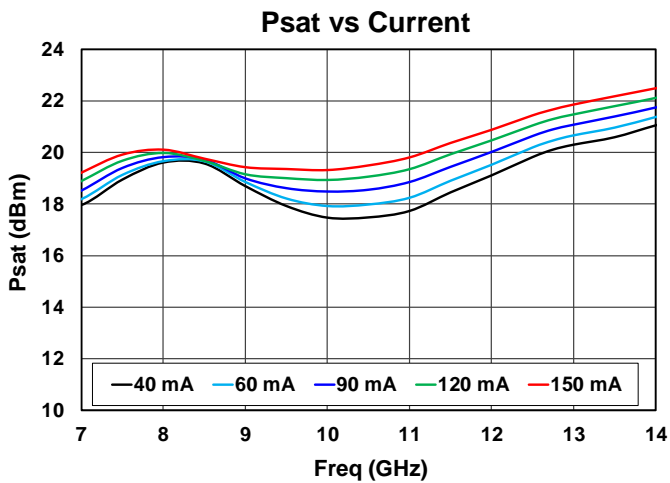
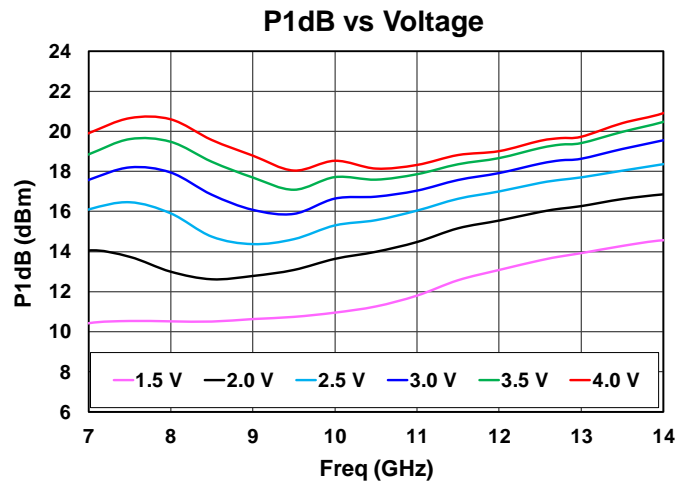
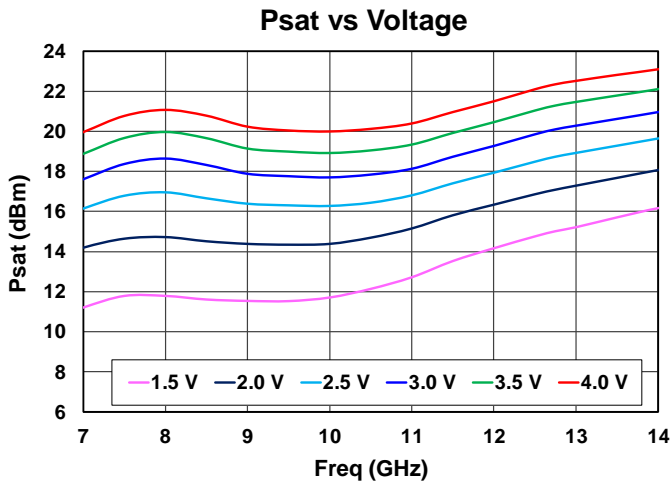
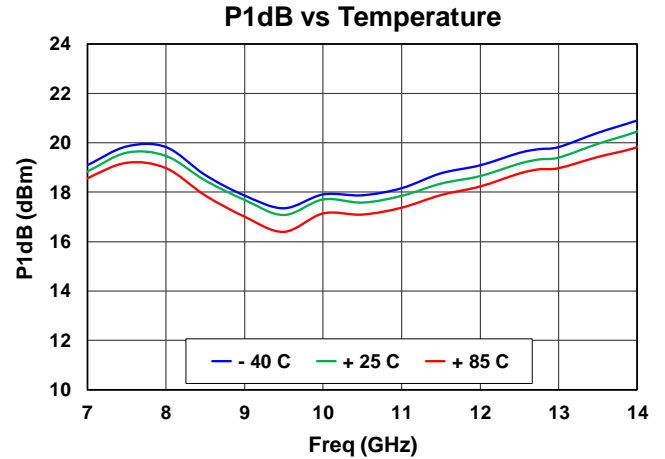
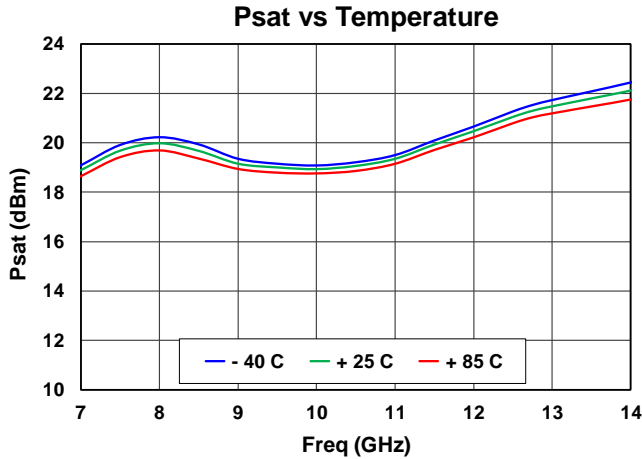

Performance Plots – Large Signal

Test conditions unless otherwise noted:  $V_D = +3.5V$ ,  $I_{DQ} = 120\text{ mA}$ , Temp. =  $+25\text{ }^\circ\text{C}$ . Data de-embedded to MMIC bond wires.

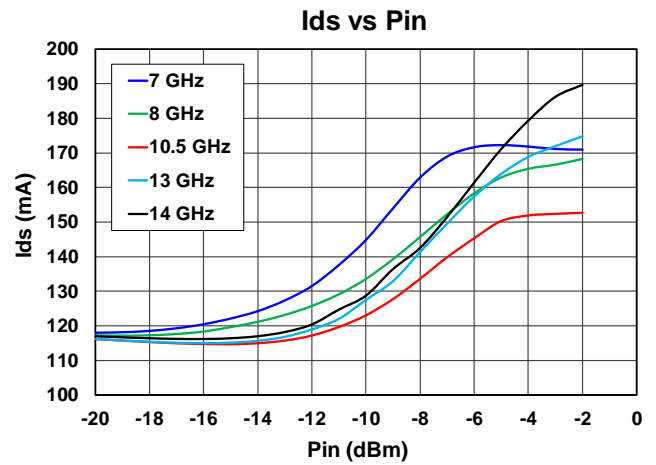
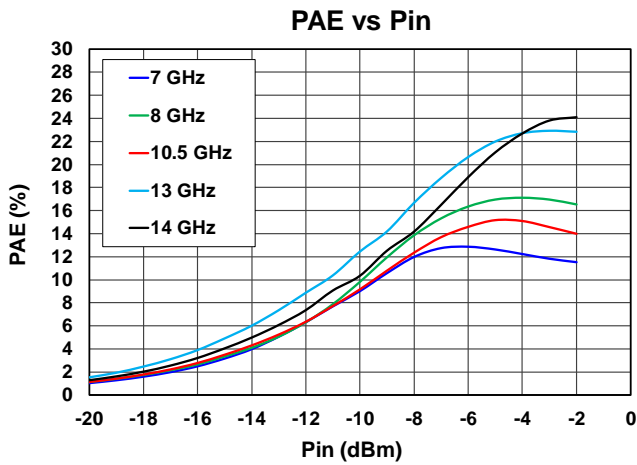
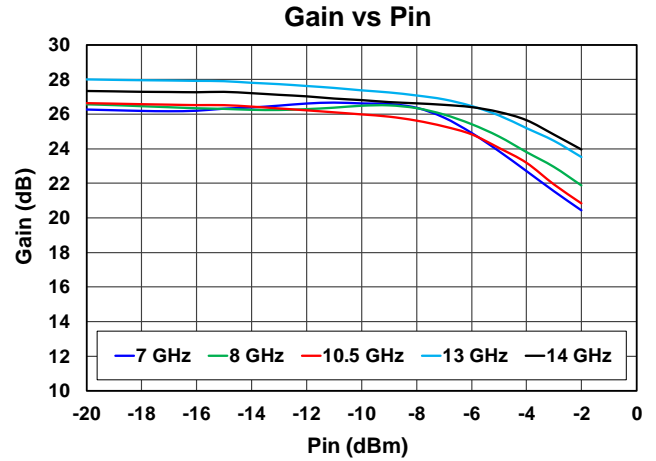
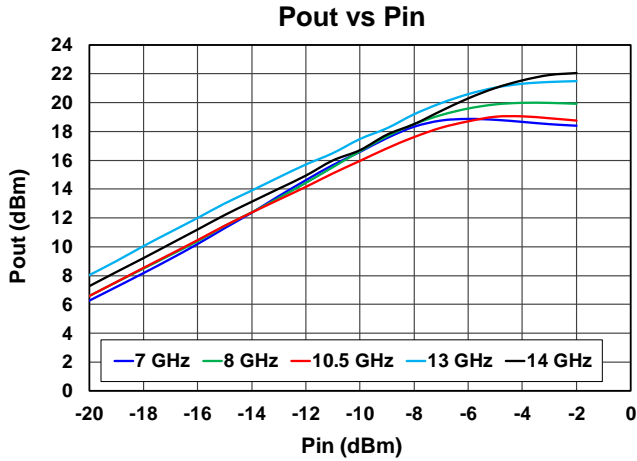

Performance Plots – Linearity

Test conditions unless otherwise noted:  $V_D = +3.5V$ ,  $I_{DQ} = 120\text{ mA}$ ,  $\Delta f = 11\text{ MHz}$ ,  $25\text{ }^\circ\text{C}$ . Data de-embedded to MMIC bond wires.

TOI vs Temperature

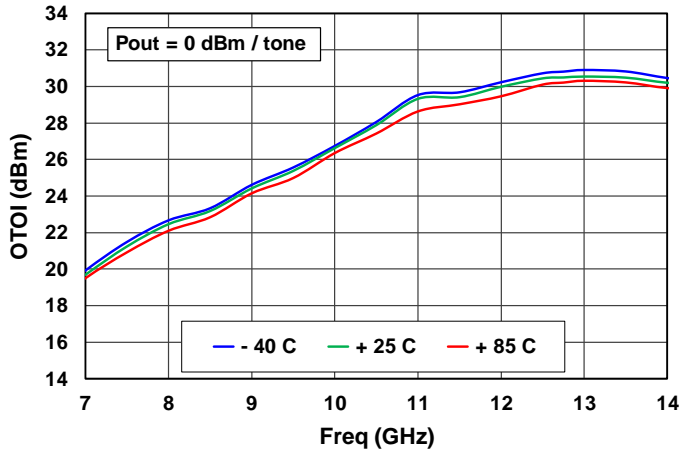

TOI vs Temperature

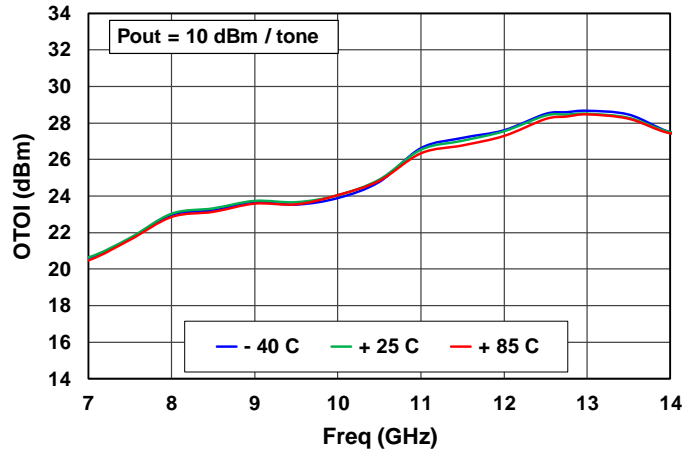

TOI vs Voltage

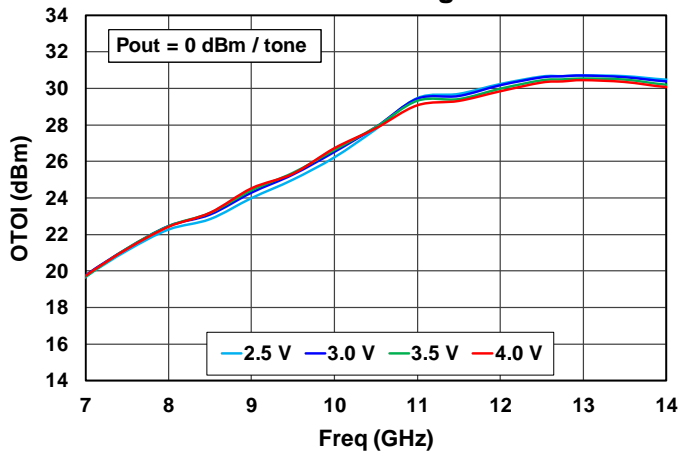

TOI vs Current

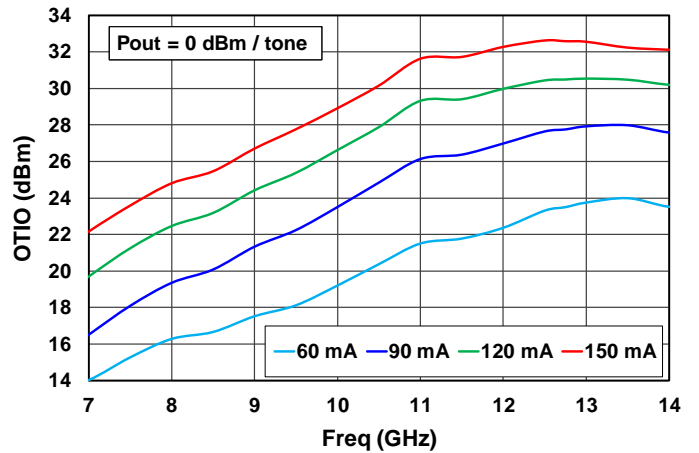



Performance Plots – Linearity

Test conditions unless otherwise noted:  $V_D = +3.5V$ ,  $I_{DQ} = 120\text{ mA}$ ,  $\Delta f = 11\text{ MHz}$ ,  $25\text{ }^\circ\text{C}$ . Data de-embedded to MMIC bond wires.

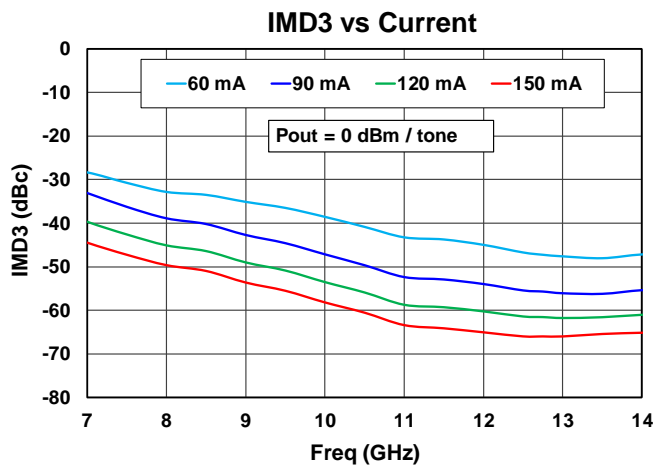
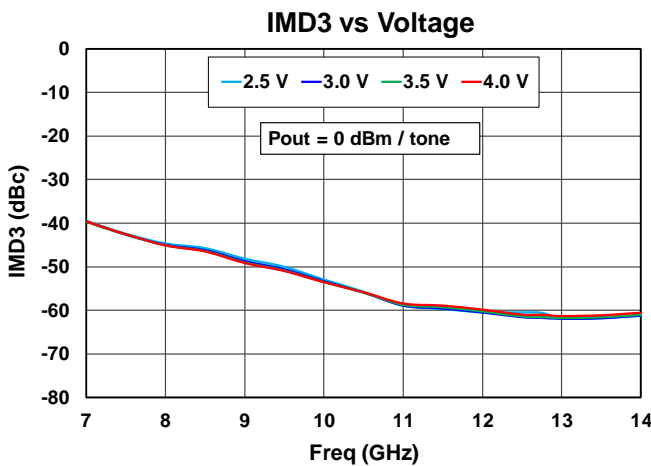
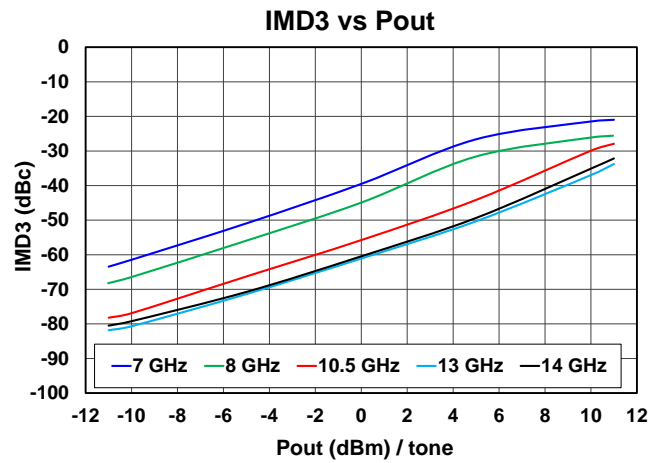
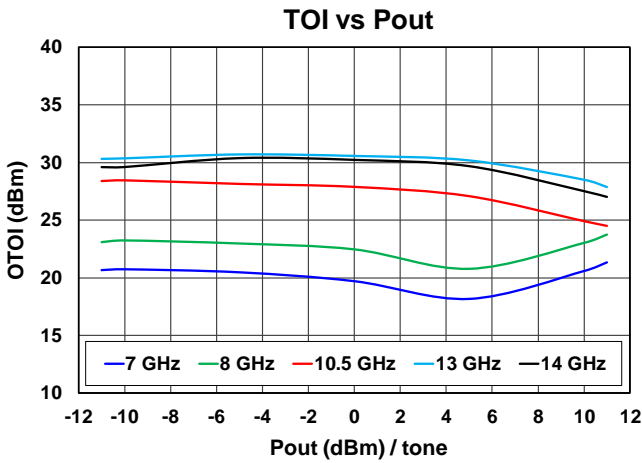
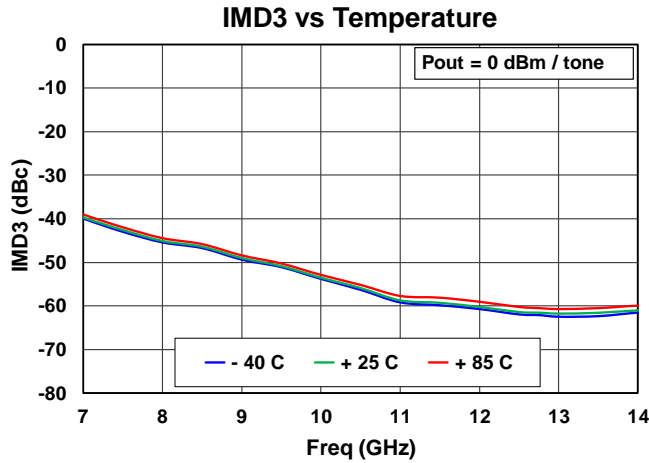

Performance Plots – Linearity

Test conditions unless otherwise noted:  $V_D = +3.5V$ ,  $I_{DQ} = 120\text{ mA}$ ,  $\Delta f = 11\text{ MHz}$ ,  $25\text{ }^\circ\text{C}$ . Data de-embedded to MMIC bond wires.

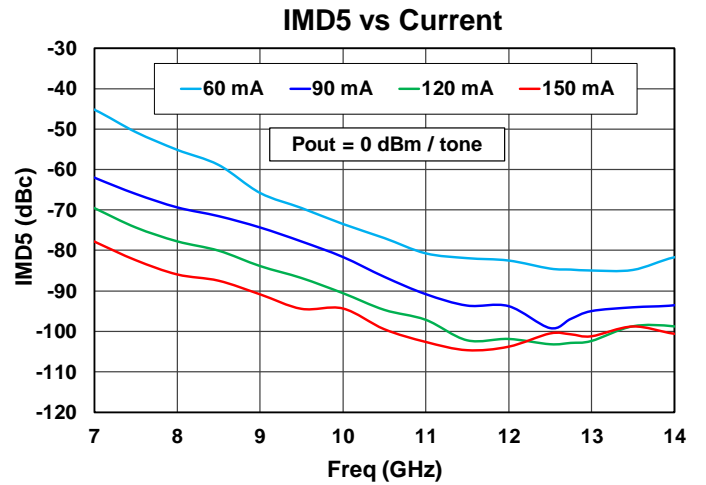
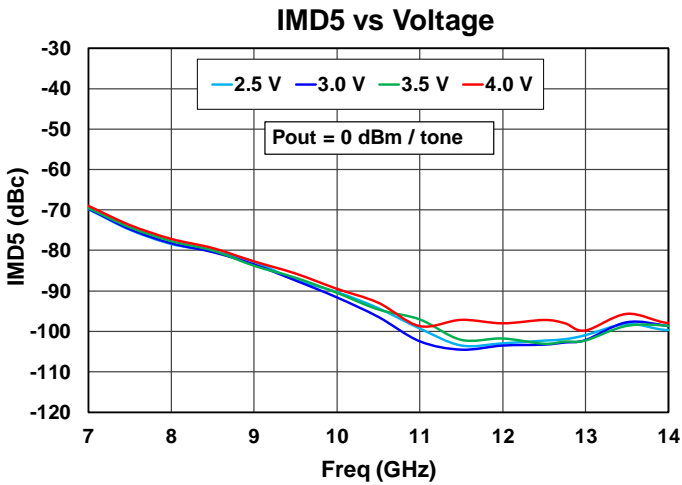
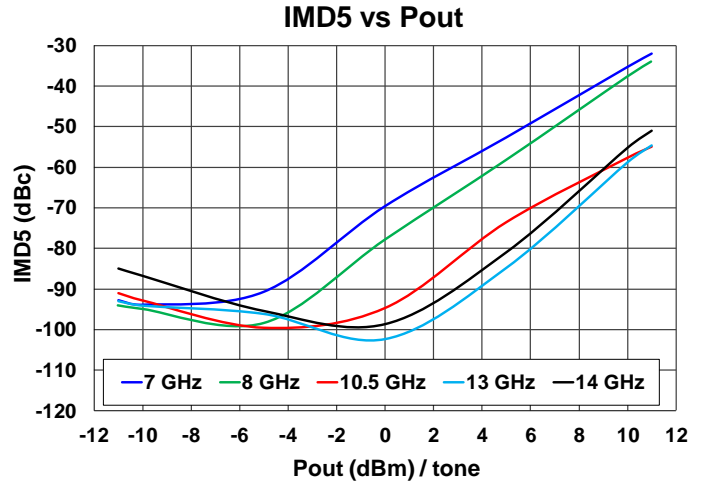
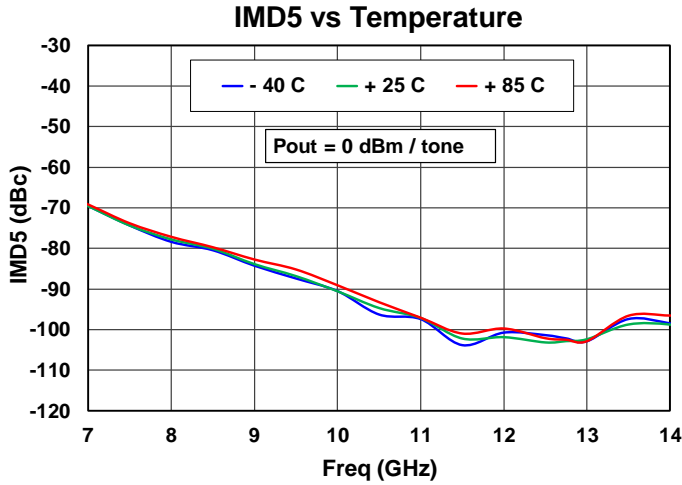

Mechanical Drawing and Bond Pad Description

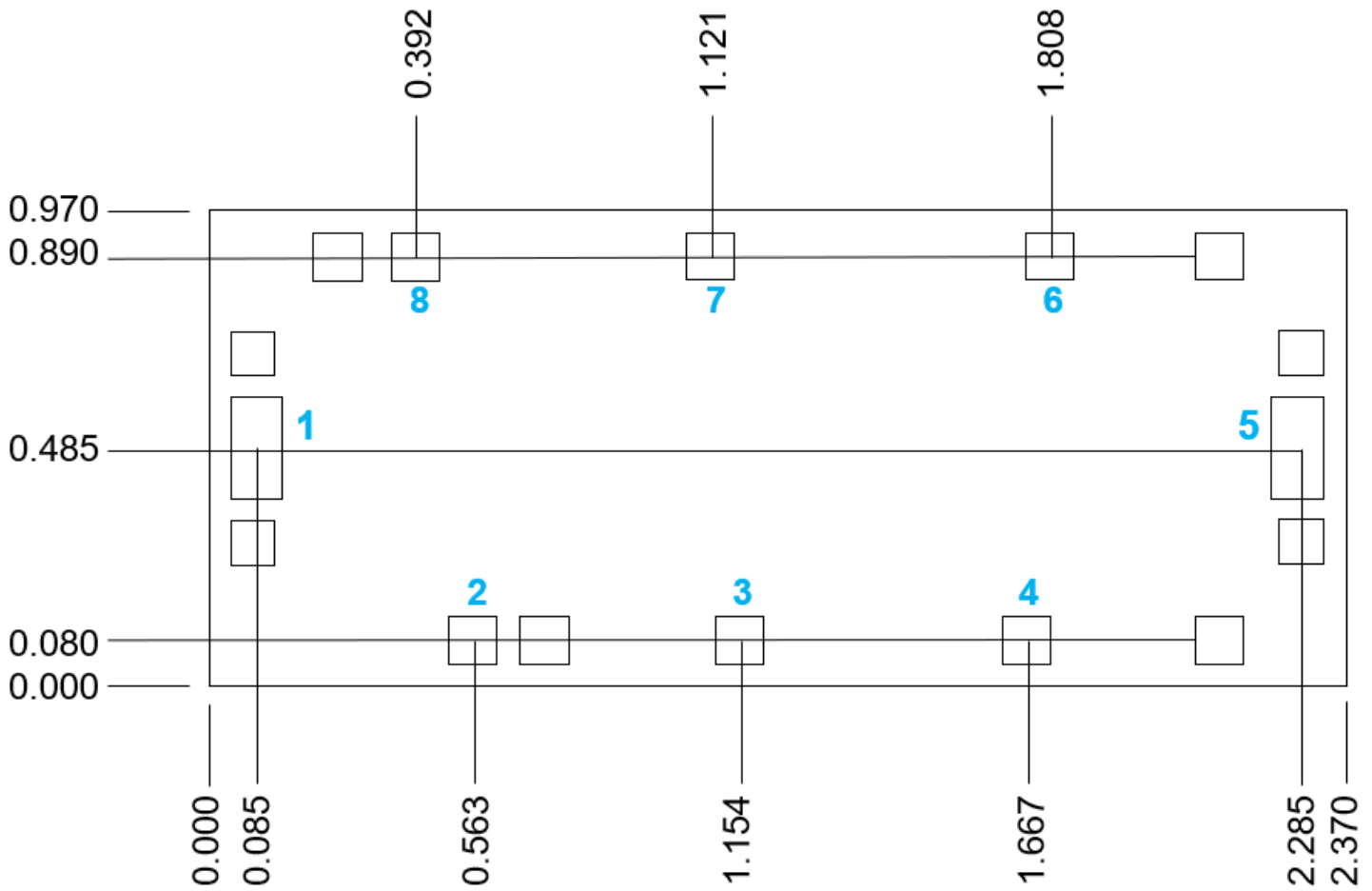

Unit: millimeters  
Die x, y size tolerance: +/- 0.010, die thickness: 0.10  
Chip edge to bond pad dimensions are shown to center of pad. Ground is backside of die

Pad No.	Label	Pad Size (um)	Description
1	RF Input	91 x 197	Matched to 50 ohms, DC blocked
2	VG1	82 x 82	Gate Voltage; bias network is required (VG can be tied together at PCB)
3	VG2	82 x 82	Gate Voltage; bias network is required (VG can be tied together at PCB)
4	VG3	82 x 82	Gate Voltage; bias network is required (VG can be tied together at PCB)
5	RF Output	91 x 197	Matched to 50 ohms, DC blocked
6	VD3	82 x 82	Drain Voltage; bias network is required (VD can be tied together at PCB)
7	VD2	82 x 82	Drain Voltage; bias network is required (VD can be tied together at PCB)
8	VD1	82 x 82	Drain Voltage; bias network is required (VD can be tied together at PCB)

## Assembly Notes

---

### Component placement and adhesive attachment assembly notes:

- Vacuum pencils and/or vacuum collets are the preferred method of pick up.
- Air bridges must be avoided during placement.
- The force impact is critical during auto placement.
- Organic attachment (i.e., conductive epoxy) can be used in low-power applications.
- Curing should be done in a convection oven; proper exhaust is a safety concern.

### Reflow process assembly notes:

- Use AuSn (80/20) solder and limit exposure to temperatures above 300°C to 3-4 minutes, maximum.
- Conductive epoxy die attach is recommended for PCB mounting.
- Bonding pads plating: Au.
- An alloy station or conveyor furnace with reducing atmosphere should be used.
- Do not use any kind of flux.
- Coefficient of thermal expansion matching is critical for long-term reliability.
- Devices must be stored in a dry nitrogen atmosphere.

### Interconnect process assembly notes:

- Thermosonic ball bonding is the preferred interconnect technique.
- Force, time, and ultrasonics are critical parameters.
- Aluminum wire should not be used.
- Devices with small pad sizes should be bonded with 0.0007-inch wire.

Evaluation Board and BOM

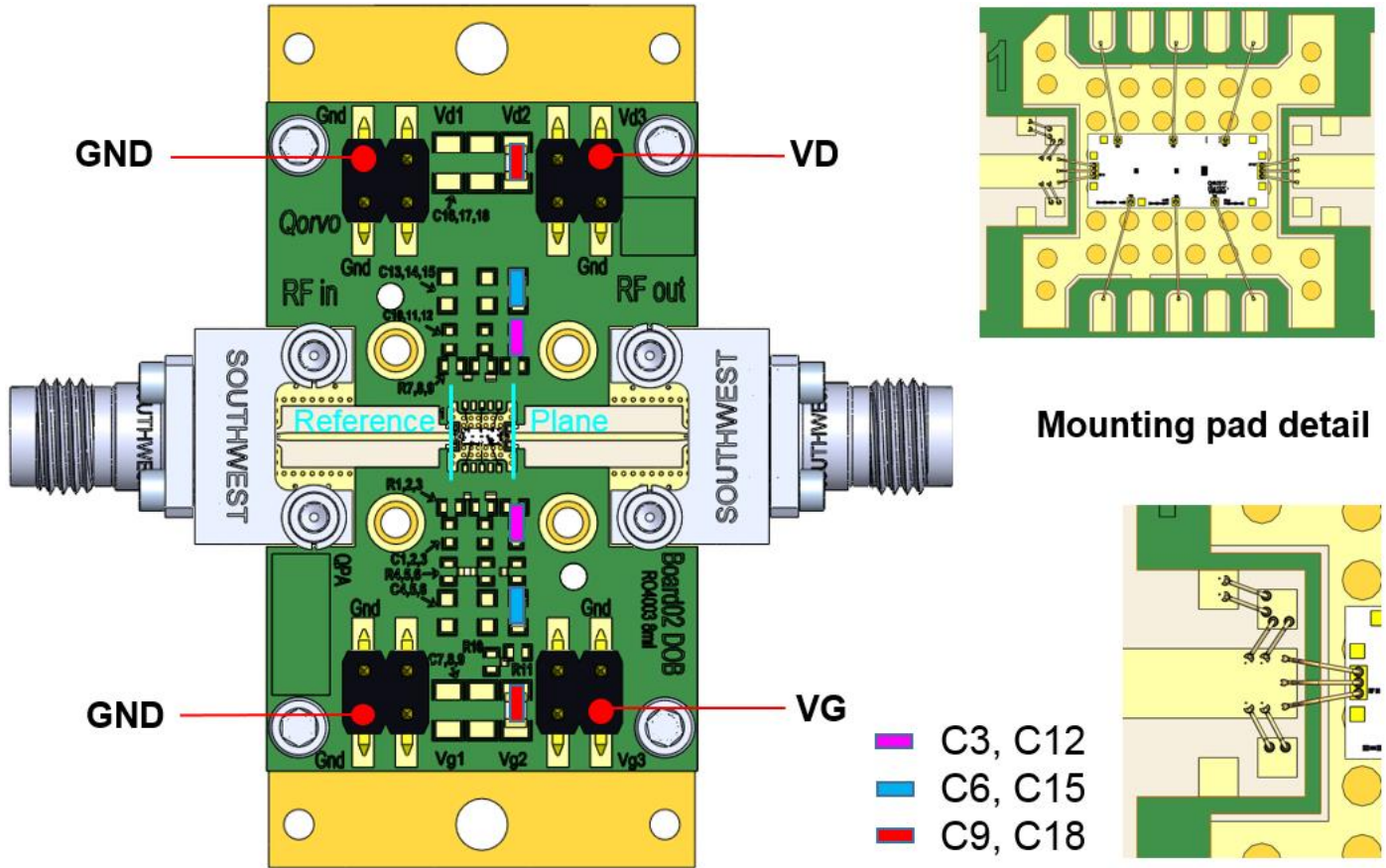

RF Layer is 0.008" thick Rogers Corp. RO4003C ( $\epsilon_r = 3.35$ ). Metal layers are 0.5 oz. copper. The microstrip line at the connector interface is optimized for the Southwest Microwave end launch connector 1092-01A-5. PCB level tuning at input side is recommended for optimal performance.

Bill of Material – Evaluation Board

Ref. Des.	Value	Description	Manuf.	Part Number
C3, C12	0.01 uF	CAP 0.01UF +/-10% 50V 0402 X7R ROHS	Various	
C6, C15	1.0 uF	CAP 1.0UF +/-10% 16V 0603 X7R ROHS	Various	
C9, C18	10 uF	CAP CER 10UF 10V X7R 10% 0805 TDK ROHS	Various	
RF IN, RF OUT	2.92 mm	2.92 MM END LAUNCH CONNECTOR	Southwest Microwave	1092-01A-5

## Application Circuit and Biasing Sequence

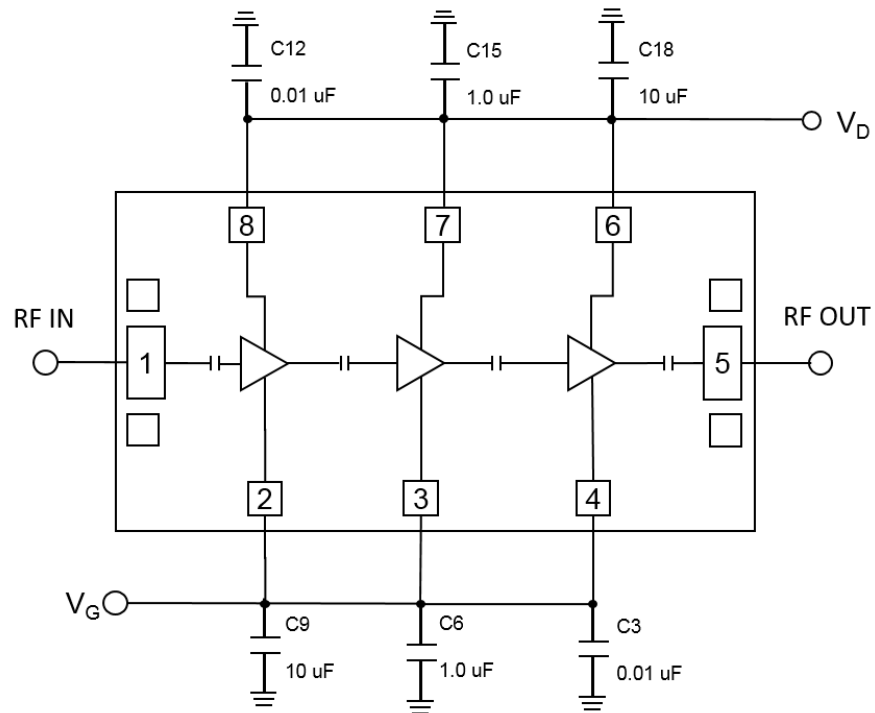

**Notes:**

1. Can use separate gate and drain for individual stage controls.

### Bias-up Procedure

1. Set  $I_D$  limit to 220 mA,  $I_G$  limit to 10 mA
2. Set  $V_G$  to  $-1.3$  V
3. Set  $V_D$  +3.5 V
4. Adjust  $V_G$  more positive until  $I_{DQ} = 120$ mA  
( $V_G \approx -0.46$  V Typical)
5. Apply RF signal

### Bias-down Procedure

1. Turn off RF signal
2. Reduce  $V_G$  to  $-1.3$  V. Ensure  $I_{DQ} \approx 0$ mA
3. Set  $V_D$  to 0V
4. Turn off  $V_D$  supply
5. Turn off  $V_G$  supply

## Thermal and Reliability Information

Parameter	Test Conditions	Value	Units
Thermal Resistance ( $\theta_{JC}$ ) <sup>(1)</sup>	$T_{base} = 85^{\circ}\text{C}$ , $V_D = 3.5\text{ V}$ , $I_{DQ} = 120\text{ mA}$ Quiescent/Small Signal operation, $P_{DISS} = 0.42\text{ W}$	65.0	$^{\circ}\text{C}/\text{W}$
Channel Temperature, $T_{CH}$ (Under RF)		112.3	$^{\circ}\text{C}$
Median Lifetime ( $T_M$ )		4.0E07	Hrs

Notes:

1. Die mounted to 40 mil CuMo carrier plate with AuSn eutectic. Thermal resistance measured at back of carrier plate.

## Median Lifetime

Test Conditions:  $V_D = +4\text{ V}$   
Failure Criteria is 10% reduction in  $I_{D\_MAX}$

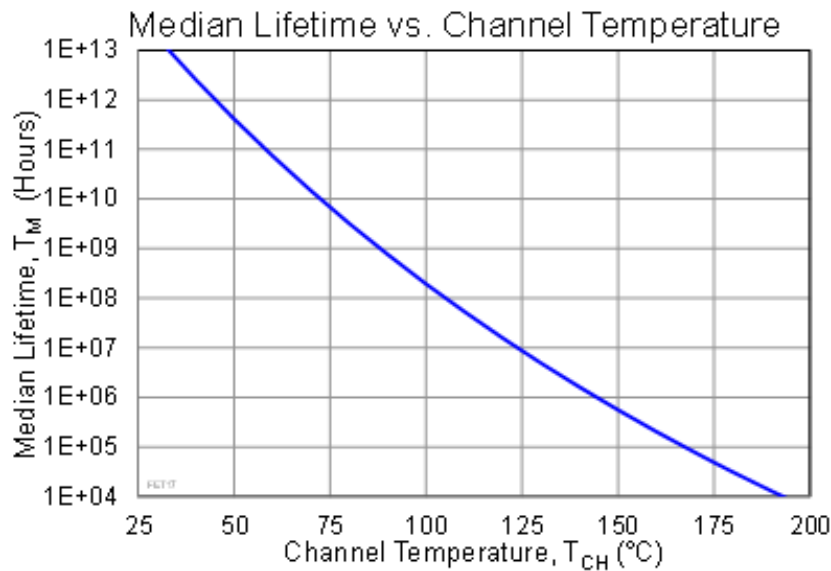

**Handling Precautions**

Parameter	Rating	Standard
ESD – Human Body Model (HBM)	1A	ESDA / JEDEC JS-001-2012



Caution!  
 ESD-Sensitive Device

**RoHS Compliance**

This part is compliant with 2011/65/EU RoHS directive (Restrictions on the Use of Certain Hazardous Substances in Electrical and Electronic Equipment) as amended by Directive 2015/863/EU.

This product also has the following attributes:

- Lead Free
- Halogen Free (Chlorine, Bromine)
- Antimony Free
- TBBP-A (C<sub>15</sub>H<sub>12</sub>Br<sub>4</sub>O<sub>2</sub>) Free
- PFOS Free
- SVHC Free

**Contact Information**

For the latest specifications, additional product information, worldwide sales and distribution locations:

**Tel: 1-844-890-8163**

**Web: [www.qorvo.com](http://www.qorvo.com)**

**Email: [customer.support@qorvo.com](mailto:customer.support@qorvo.com)**

**Important Notice**

The information contained in this Data Sheet and any associated documents (“Data Sheet Information”) is believed to be reliable; however, Qorvo makes no warranties regarding the Data Sheet Information and assumes no responsibility or liability whatsoever for the use of said information. All Data Sheet Information is subject to change without notice. Customers should obtain and verify the latest relevant Data Sheet Information before placing orders for Qorvo® products. Data Sheet Information or the use thereof does not grant, explicitly, implicitly or otherwise any rights or licenses to any third party with respect to patents or any other intellectual property whether with regard to such Data Sheet Information itself or anything described by such information.

DATA SHEET INFORMATION DOES NOT CONSTITUTE A WARRANTY WITH RESPECT TO THE PRODUCTS DESCRIBED HEREIN, AND QORVO HEREBY DISCLAIMS ANY AND ALL WARRANTIES WITH RESPECT TO SUCH PRODUCTS WHETHER EXPRESS OR IMPLIED BY LAW, COURSE OF DEALING, COURSE OF PERFORMANCE, USAGE OF TRADE OR OTHERWISE, INCLUDING THE IMPLIED WARRANTIES OF MERCHANTABILITY AND FITNESS FOR A PARTICULAR PURPOSE. Without limiting the generality of the foregoing, Qorvo® products are not warranted or authorized for use as critical components in medical, life-saving, or life-sustaining applications, or other applications where a failure would reasonably be expected to cause severe personal injury or death. Applications described in the Data Sheet Information are for illustrative purposes only. Customers are responsible for validating that a particular product described in the Data Sheet Information is suitable for use in a particular application.

© 2022 Qorvo US, Inc. All rights reserved. This document is subject to copyright laws in various jurisdictions worldwide and may not be reproduced or distributed, in whole or in part, without the express written consent of Qorvo US, Inc. | QORVO® is a registered trademark of Qorvo US, Inc.