

Product Overview

Qorvo's CMD235 is a broadband MMIC SP5T switch in die form. The CMD235 covers DC to 18 GHz and offer low insertion loss of 2.2 dB and high isolation of 30 to 50 dB (depending on port) at 10 GHz. The switch also includes an on board binary decoder circuit which reduces the number of required logic control lines from five to three. The CMD235 operates using voltage control logic lines of 0/5 V and consumes minimal DC current.

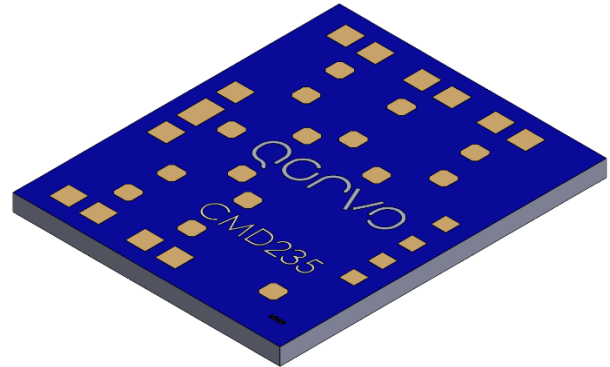

Functional Block Diagram

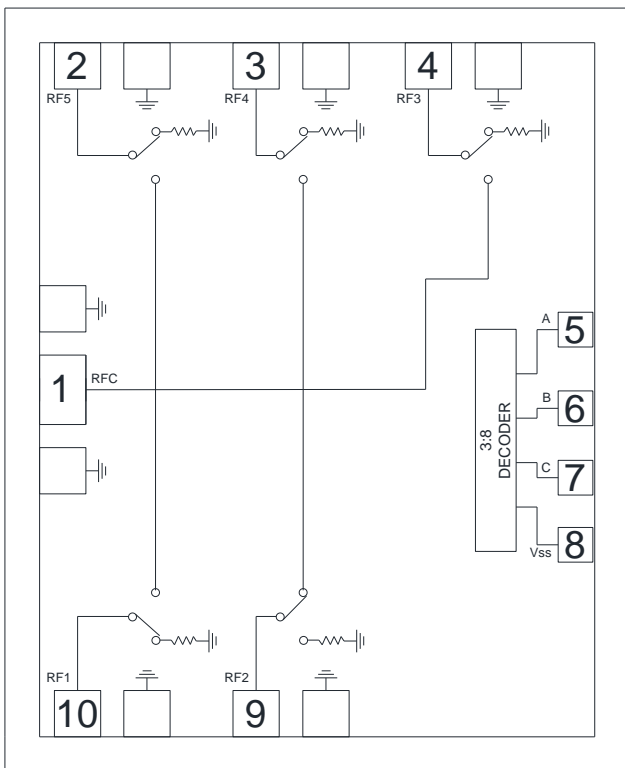

Key Features

- Broadband design: DC to 18 GHz
- Low insertion loss of 2.2 dB at 10 GHz
- High isolation of 30 to 50 dB at 10 GHz
- Non-reflective design
- Integrated 3:8 TTL decoder
- All OFF state included

Performance is typical across frequency. Please reference electrical specification table and data plots for more details.

Applications

- Multiplexing
- Signal routing
- Signal termination
- Antenna array

Ordering Information

Part No.	Description
CMD235	Gel Pack Qty=50

Absolute Maximum Ratings

Parameter	Rating
RF input power, CW, 25 °C	+27 dBm
Bias Voltage (Vss)	-7 V
Control Voltage Range (A, B, C)	+0.5 V to -7.5 V
Channel Temperature, Tch	150 °C
Operating Temperature	-55 to 85 °C
Storage Temperature	-55 to 150 °C

Exceeding any one or a combination of the Absolute Maximum Rating conditions may cause permanent damage to the device. Extended application of Absolute Maximum Rating conditions to the device may reduce device reliability.

Recommended Operating Conditions

Parameter	Min	Typ.	Max	Units
LOW logic voltage level	-1		0	V
LOW logic current		1		mA
HIGH logic voltage level	-7		-3	V
HIGH logic current		1		uA
Bias Voltage, Vss		-5		V
Bias Current, Iss		7	14	mA
Temperature Range	-55	+25	+85	°C

Electrical specifications are measured at specified test conditions. Specifications are not guaranteed over all recommended operating conditions.

Electrical Specifications

Test conditions unless otherwise noted: 25 °C, Frequency = 10 GHz, Vss = -5 V, V_{CTL} (A, B, C) = 0/-5 V

Parameter	Min	Typ.	Max	Units
Frequency Range	DC	–	18	GHz
Insertion Loss	Frequency = DC – 6 GHz	1.7		dB
	Frequency = DC – 15 GHz	2.8		dB
	Frequency = DC – 18 GHz	3.4		dB
RFC-RFx Isolation	Frequency = DC – 6 GHz	38		dB
	Frequency = DC – 15 GHz	35		dB
	Frequency = DC – 18 GHz	34		dB
Return Loss – ON State Common Port (RFC)	Frequency = DC – 6 GHz	12		dB
	Frequency = DC – 15 GHz	10		dB
	Frequency = DC – 18 GHz	12		dB
Return Loss – OFF State Switched State (RFx)	Frequency = DC – 6 GHz	12		dB
	Frequency = DC – 15 GHz	14		dB
	Frequency = DC – 18 GHz	15		dB
Input P0.1dB		18		dBm
Input IP3		36		dBm
Switching Speed		60		ns

Truth Table

Control Voltage Input			Signal Path State
A	B	C	RFC to:
High	High	High	RF1
Low	High	High	RF2
High	Low	High	RF3
Low	Low	High	RF4
High	High	Low	RF5
Low	Low	Low	All OFF*

LOW = 0 to -1 V @ 1 mA (typical)

HIGH = -3 V to -7 V @ 1 uA (typical)

* RFC is reflective in All OFF state

Typical Performance

Insertion Loss vs. Frequency

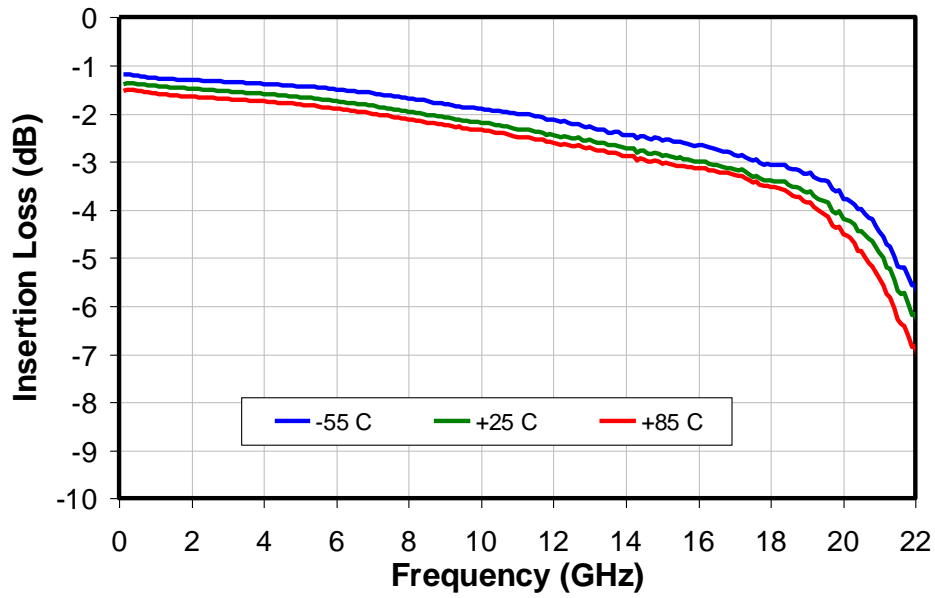

Return Loss vs. Frequency

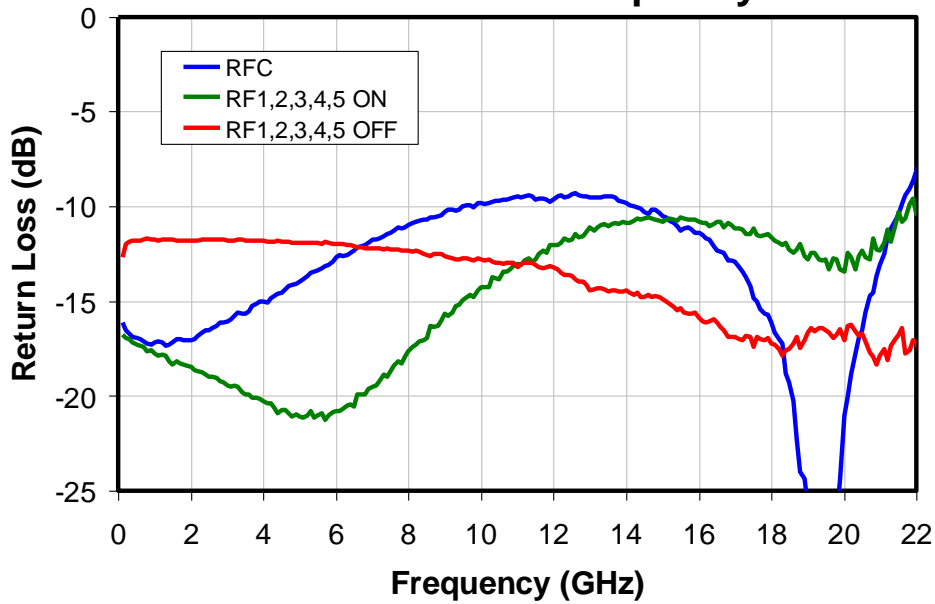

Typical Performance – RFC to RF1/RF2/RF3/RF4/RF5 Isolation

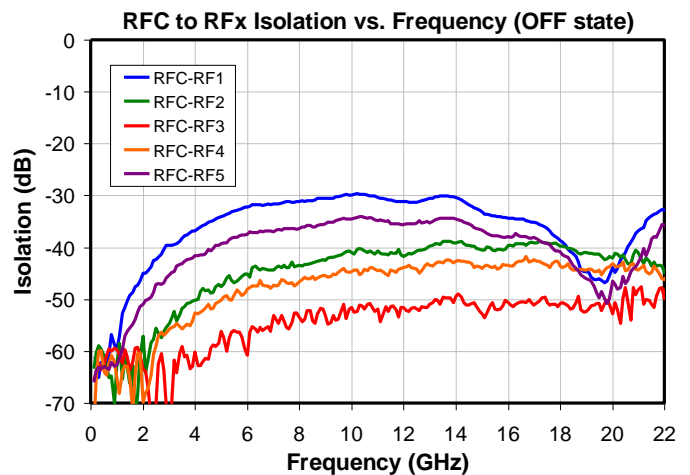
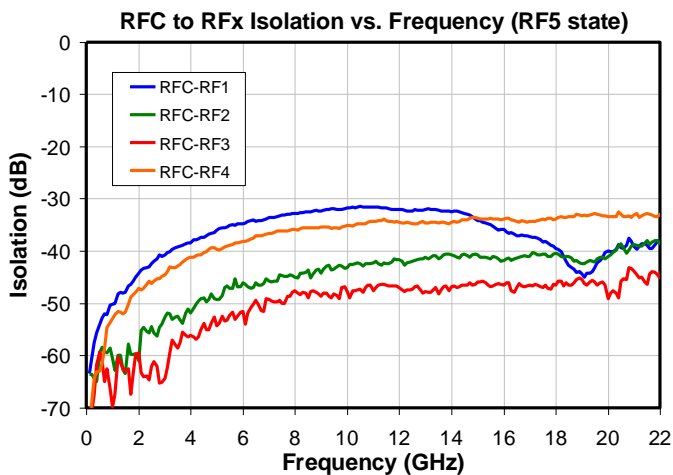
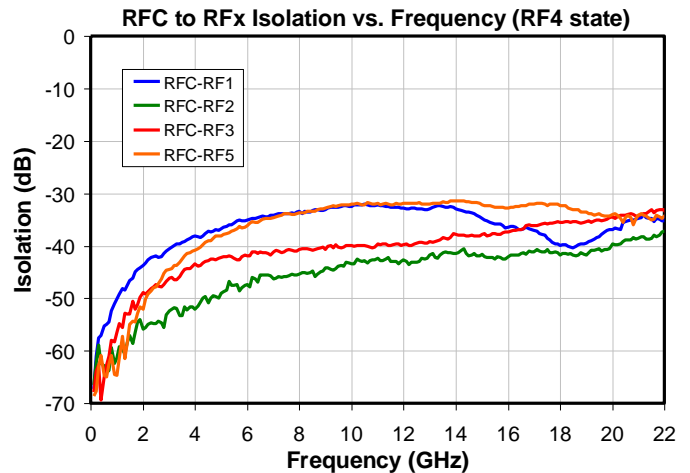
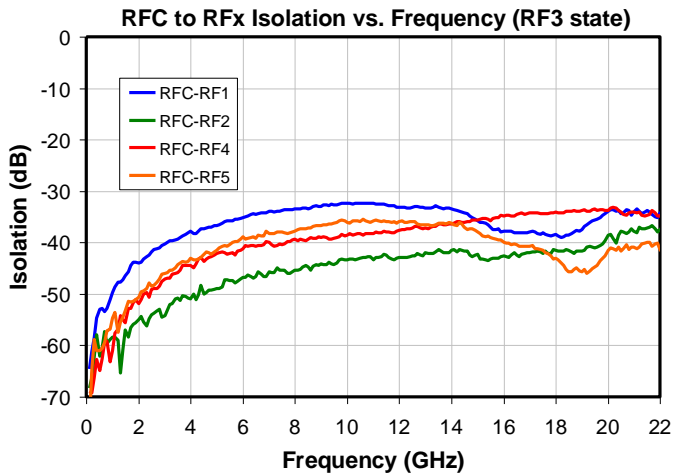
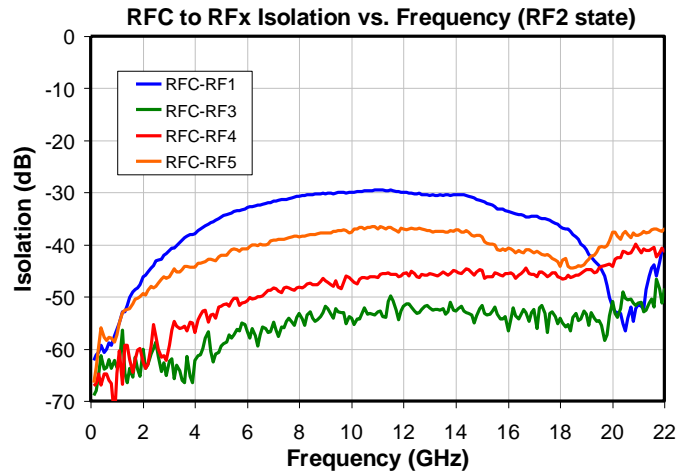
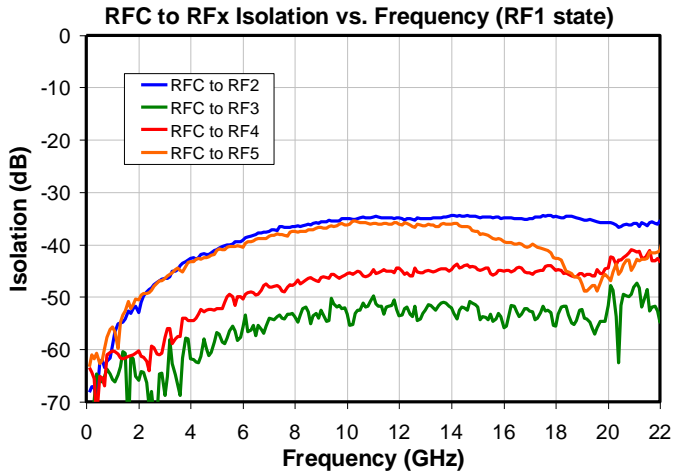

Typical Performance – Isolation between Ports RFx and RFy

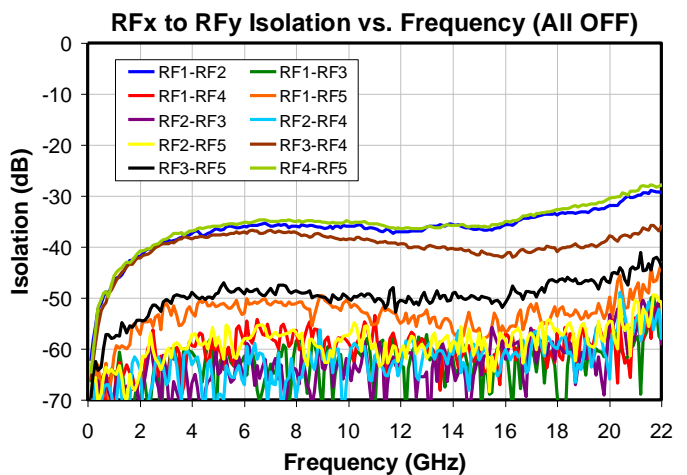
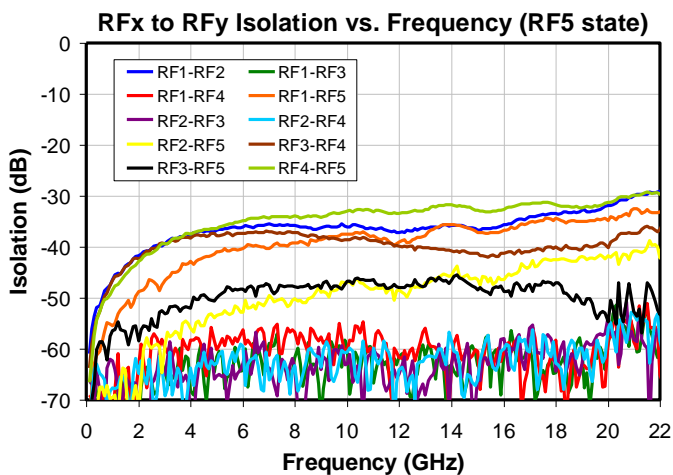
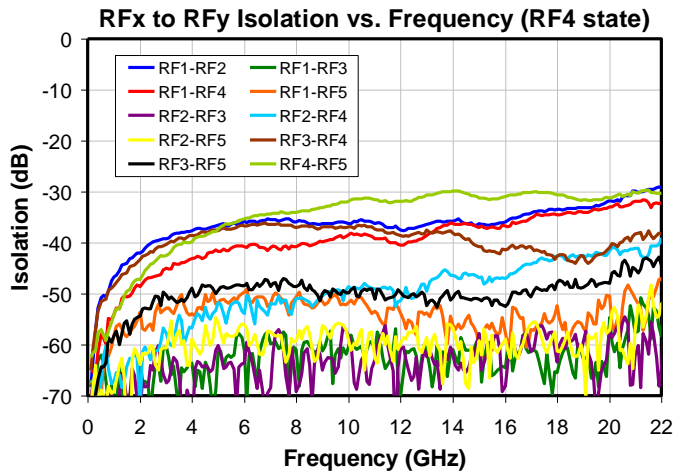
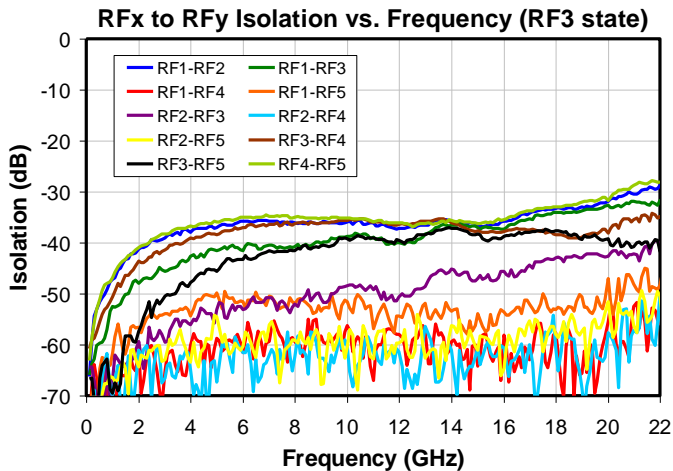
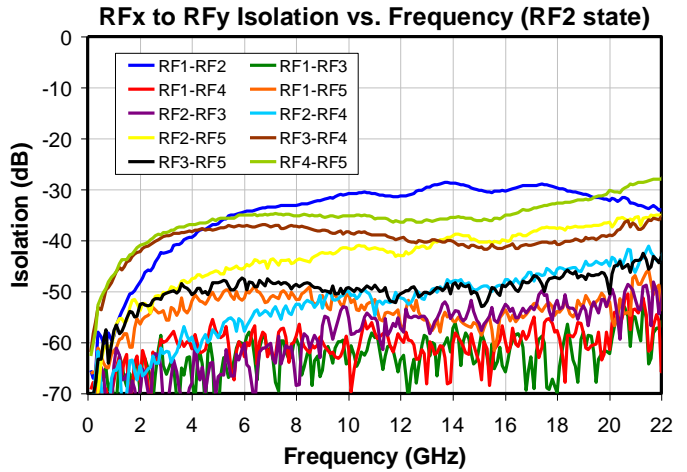
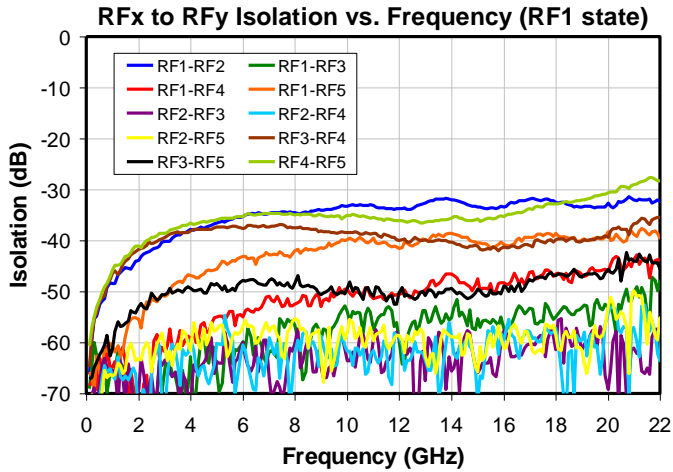

Typical Performance

Input P0.1dB vs. Frequency

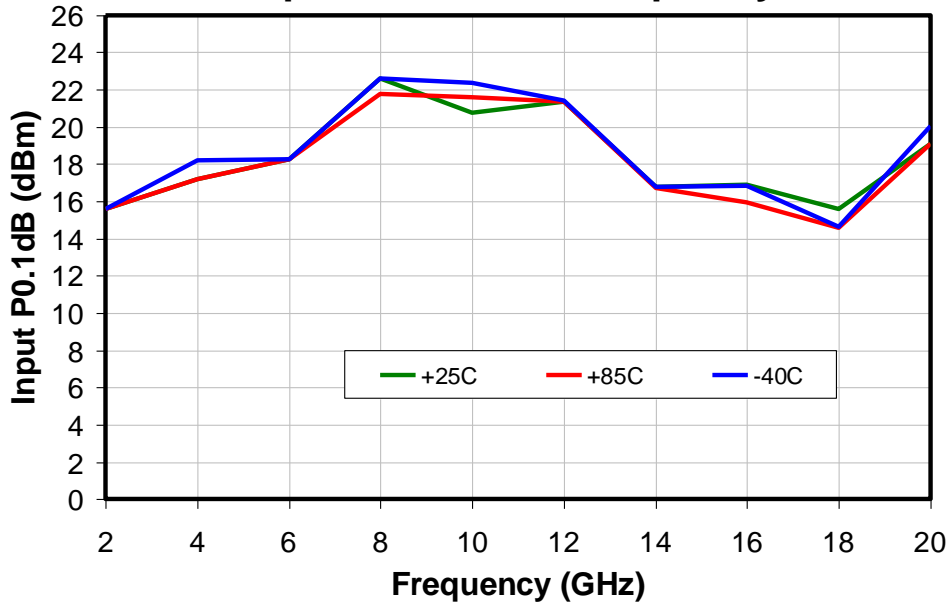

Input IP3 vs. Frequency

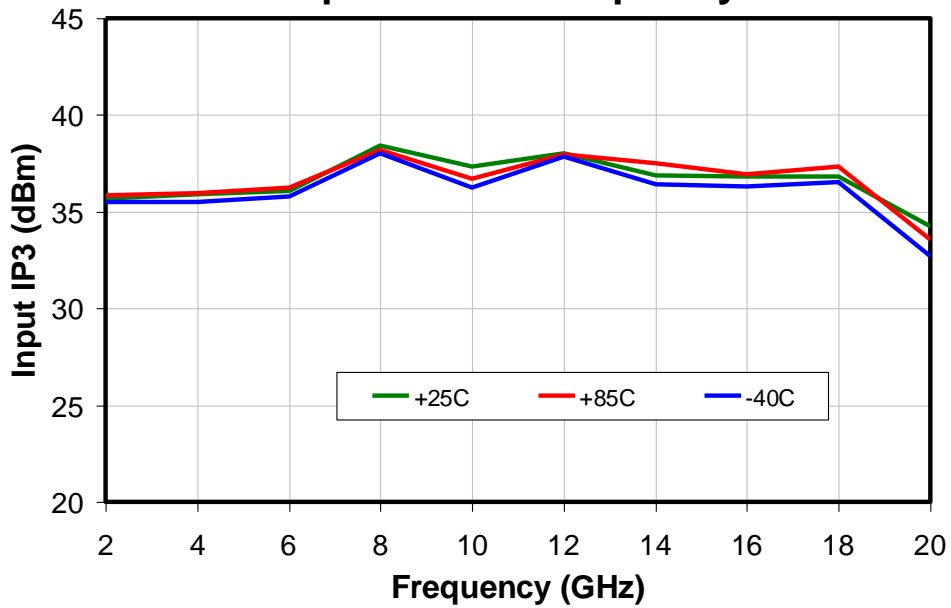

Thermal and Reliability Information

Parameter	Test Conditions	Value	Units
Thermal Resistance (θ_{JC}) ⁽¹⁾ (insertion loss path)	$T_{BASE} = 85\text{ }^{\circ}\text{C}$, $V_{SS} = -5\text{ V}$, $V_{CTL} = 0/-5\text{ V}$, CW, Frequency = 2 GHz, $P_{IN} = 20\text{ dBm}$ (0.1 W), Insertion Loss = 2 dB, $P_{OUT} = 18\text{ dBm}$ (0.063 W), $P_{DISS} = 0.037\text{ W}$	81.9	$^{\circ}\text{C/W}$
Thermal Resistance (θ_{JC}) ⁽¹⁾ (terminated path)		531.12	$^{\circ}\text{C/W}$
Channel Temperature (T_{CH}) ⁽¹⁾		93.2	$^{\circ}\text{C}$
Median Lifetime (T_M)		1E13	Hrs

Notes:

1. Measured to the back of the die.

Median Lifetime, Channel Temperature & Power Dissipation

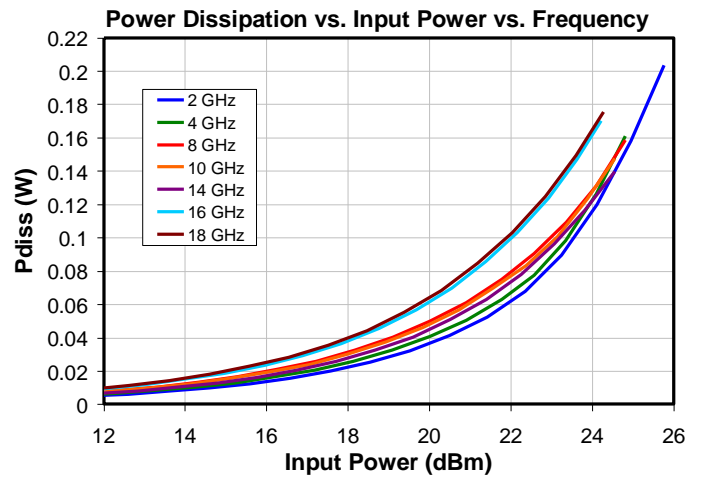
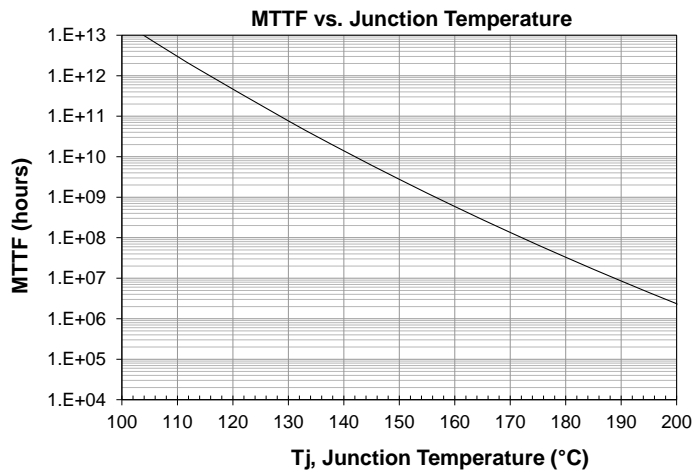

Mechanical Information

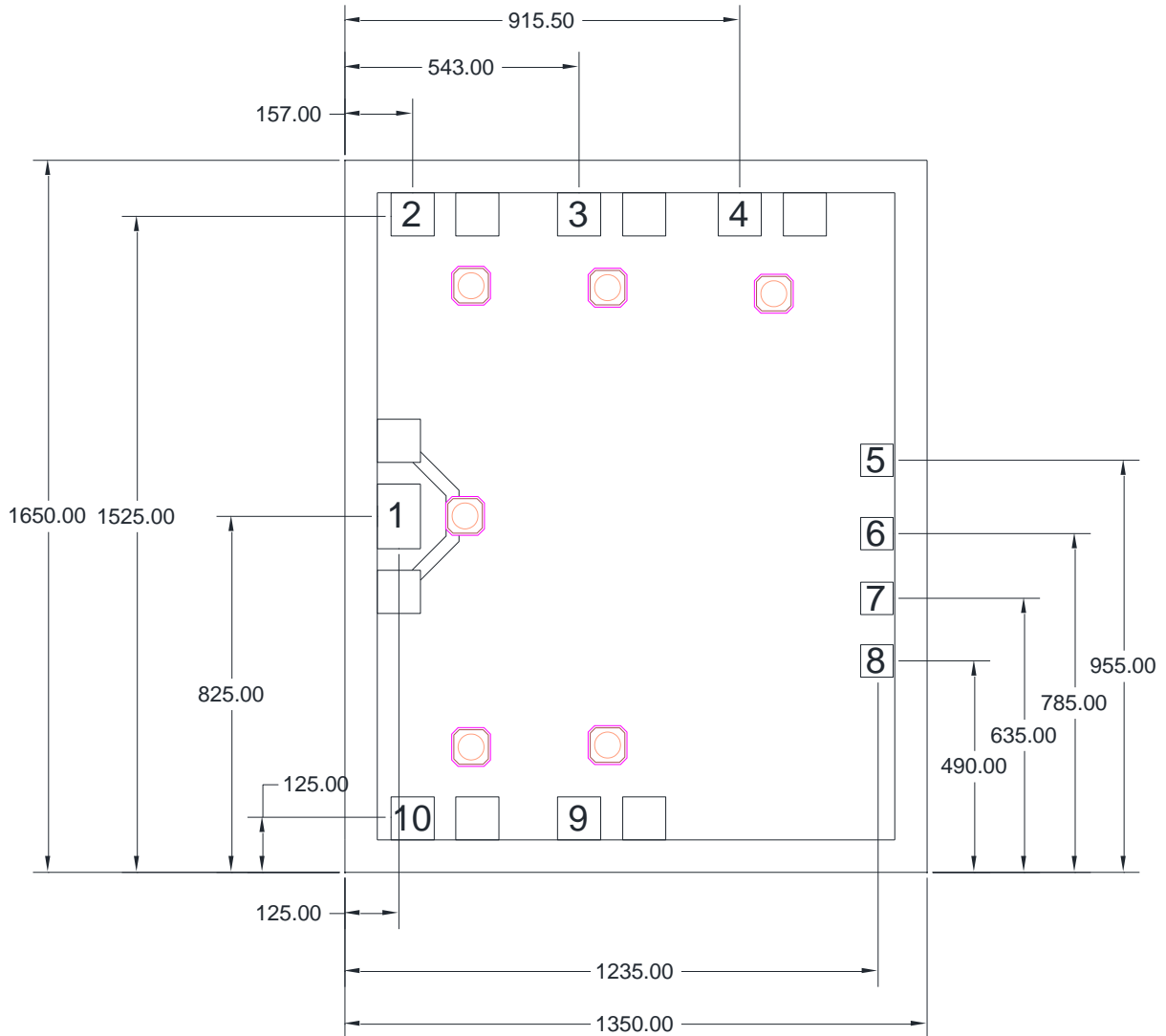

Notes:

1. All dimensions in microns.
2. No connection required for unlabeled grounds
3. Backside is RF and DC ground.
4. Backside and bond pad metal: Gold.
5. Die is 85 um thick.
6. Bond pad (1) is 100 x 150 um, bond pads (2-4, 9, 10) are 100 x 100 um, and bond pads (5-8) are 75 x 75 um.

Pin Diagram

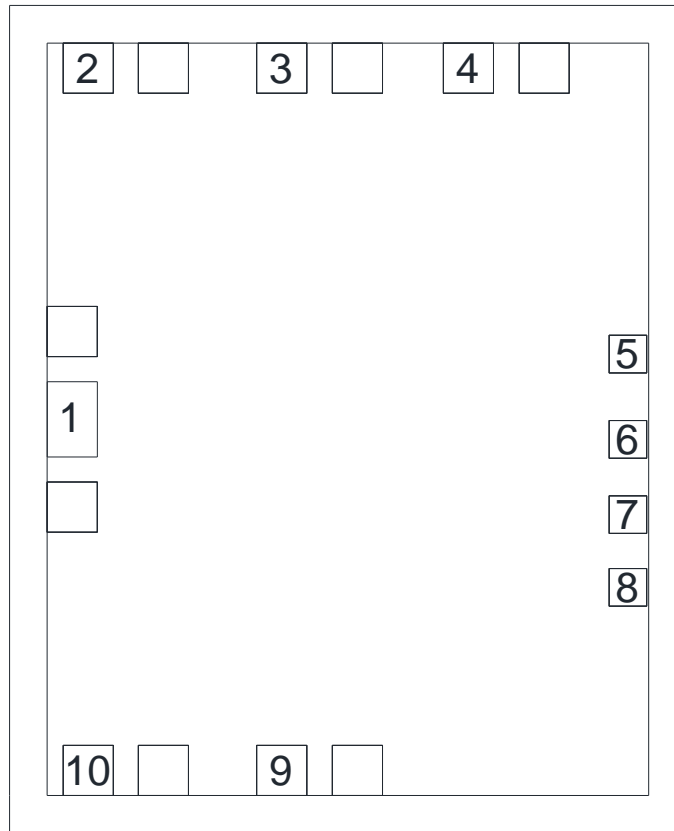

Bond Pad Description

Pad No.	Symbol	Pad Size (um)	Description
1	RFC	100 x 150	This pin is DC coupled and matched to 50 Ohms. Blocking capacitor is required if RF line potential is not equal to 0 V.
2-4, 9, 10	RF5, RF4, RF3, RF2, RF1	100 x 100	These pins are DC coupled and matched to 50 Ohms. Blocking capacitor is required if RF line potential is not equal to 0 V.
5-8	A, B, C	75 x 75	Logic state control pads. See truth table and control voltage table.
8	Vss	75 x 75	Power supply voltage
Backside	Ground		Connect to RF / DC ground

Assembly Guidelines

The backside of the CMD235 is RF ground. Die attach should be accomplished with electrically and thermally conductive epoxy only. Eutectic attach is not recommended. Standard assembly procedures should be followed for high frequency devices. The top surface of the semiconductor should be made planar to the adjacent RF transmission lines.

RF connections should be made as short as possible to reduce the inductive effect of the bond wire. Use of a 0.8 mil thermosonic wedge bonding is highly recommended as the loop height will be minimized.

The semiconductor is 100 μm thick and should be handled by the sides of the die or with a custom collet. Do not make contact directly with the die surface as this will damage the monolithic circuitry. Handle with care.

Assembly Diagram

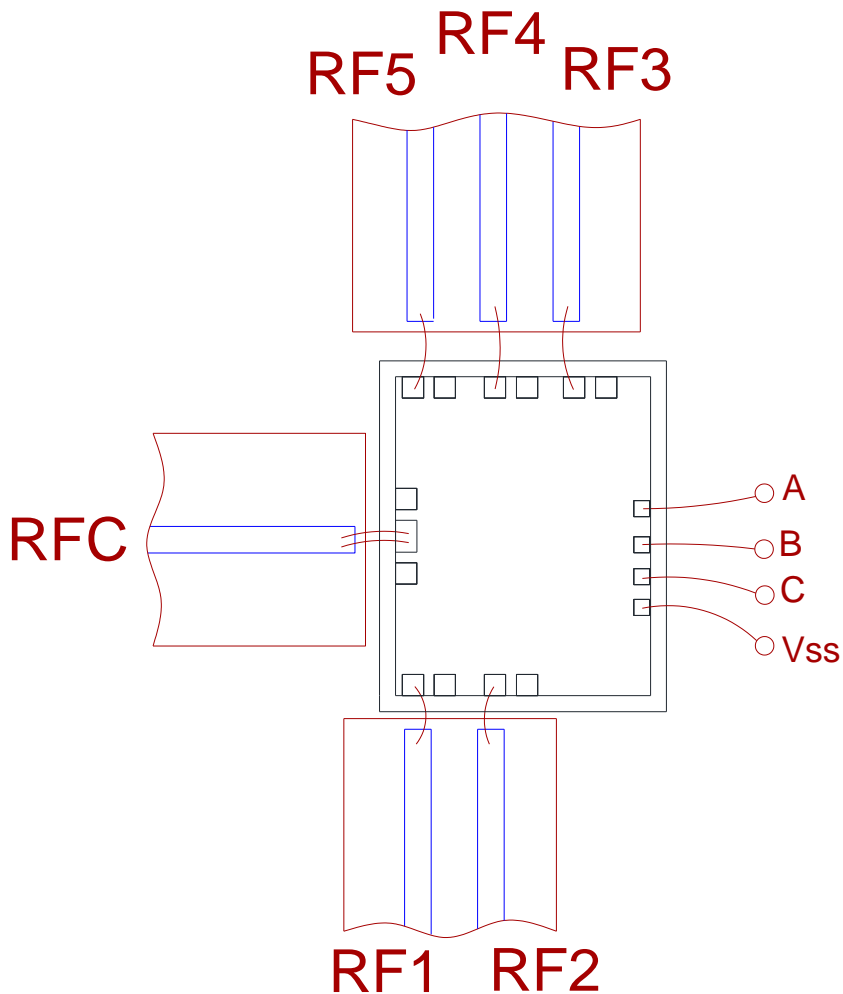

Handling Precautions

Parameter	Rating	Standard
ESD – Human Body Model (HBM)	Class 1A	ESDA / JEDEC JS-001-2012
MSL – Convection Reflow 235 °C	N/A	JEDEC standard IPC/JEDEC J-STD-020



Caution!
ESD-Sensitive Device

RoHS Compliance

This part is compliant with 2011/65/EU RoHS directive (Restrictions on the Use of Certain Hazardous Substances in Electrical and Electronic Equipment) as amended by Directive 2015/863/EU.

This product also has the following attributes:

- Lead Free
- Halogen Free (Chlorine, Bromine)
- Antimony Free
- TBBP-A (C₁₅H₁₂Br₄O₂) Free
- PFOS Free
- SVHC Free

Contact Information

For the latest specifications, additional product information, worldwide sales and distribution locations:

Web: www.qorvo.com

Tel: 1-844-890-8163

Email: customer.support@qorvo.com

Important Notice

The information contained herein is believed to be reliable; however, Qorvo makes no warranties regarding the information contained herein and assumes no responsibility or liability whatsoever for the use of the information contained herein. All information contained herein is subject to change without notice. Customers should obtain and verify the latest relevant information before placing orders for Qorvo products. The information contained herein or any use of such information does not grant, explicitly or implicitly, to any party any patent rights, licenses, or any other intellectual property rights, whether with regard to such information itself or anything described by such information. **THIS INFORMATION DOES NOT CONSTITUTE A WARRANTY WITH RESPECT TO THE PRODUCTS DESCRIBED HEREIN, AND QORVO HEREBY DISCLAIMS ANY AND ALL WARRANTIES WITH RESPECT TO SUCH PRODUCTS WHETHER EXPRESS OR IMPLIED BY LAW, COURSE OF DEALING, COURSE OF PERFORMANCE, USAGE OF TRADE OR OTHERWISE, INCLUDING THE IMPLIED WARRANTIES OF MERCHANTABILITY AND FITNESS FOR A PARTICULAR PURPOSE.**

Without limiting the generality of the foregoing, Qorvo products are not warranted or authorized for use as critical components in medical, life-saving, or life-sustaining applications, or other applications where a failure would reasonably be expected to cause severe personal injury or death.

Copyright 2020 © Qorvo, Inc. | Qorvo is a registered trademark of Qorvo, Inc.