

Product Overview

Qorvo’s QPM1017 is a packaged, high-power C-band amplifier module, fabricated on Qorvo’s production 0.15 μm GaN on SiC process (QGaN15). Covering 5.7 – 7 GHz, the QPM1017 provides 100 W of saturated output power with 18 dB of large signal gain while achieving > 35% power-added efficiency. For satellite communications applications, QPM1017 provides 40 W linear power with 25 dBc third order intermodulation distortion products.

The QPM1017 is packaged in a 10-lead 19.05 x 19.05 mm bolt-down package with a Cu base for superior thermal management. It can support a variety of operating conditions to best support system requirements.

To simplify system integration, QPM1017 is fully matched to 50 ohms. Input port is DC grounded for improved ESD performance, output port is AC coupled with integrated DC blocking capacitor.

The QPM1017 is ideal for supporting communications and radar applications in both commercial and military markets

RoHS compliant

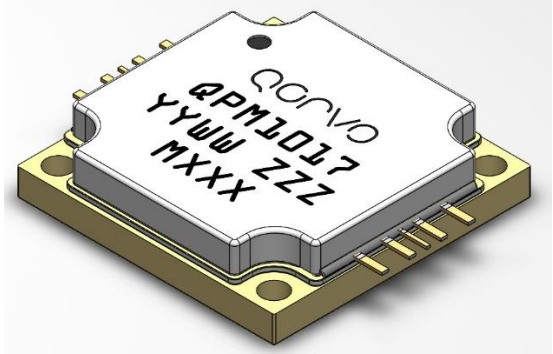

Key Features

- Frequency Range: 5.7 – 7 GHz
- P_{SAT} ($P_{IN} = 32$ dBm): 50 dBm
- PAE ($P_{IN} = 32$ dBm): > 35 %
- Power Gain ($P_{IN} = 32$ dBm): 18 dB
- IM3 ($P_{OUT}/Tone = 43$ dBm): -25 dBc
- Small Signal Gain: > 24 dB
- Bias: $V_D = +24$ V, $I_{DQ} = 3.4$ A, $V_G = -2.5$ V typ.
- Dimensions: 19.05 x 19.05 x 4.5 mm

Performance is typical across frequency. Please reference electrical specification table and data plots for more details.

Functional Block Diagram

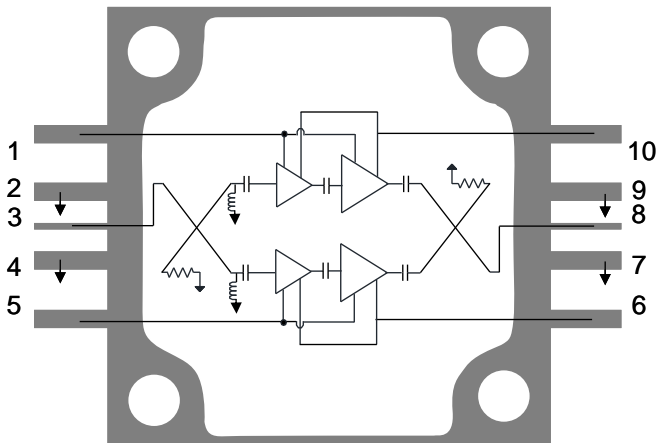

Applications

- C-Band Radar
- Satellite Communications

Ordering Information

Part No.	Description
QPM1017	5.7 – 7 GHz 100 W GaN Power Amplifier Module (10 pcs. pack)
QPM1017S2	Samples (2 pcs. pack)
QPM1017EVB	Evaluation Board for QPM1017

Absolute Maximum Ratings

Parameter	Value / Range
Drain Voltage (V_D)	29.5 V
Gate Voltage Range (V_G)	-6 V to 0 V
Drain Current (I_D)	20 A
Gate Current (I_G)	See plot page 18
Power Dissipation (P_{DISS}), 85 °C	Pulsed, 360 W CW, 200 W
Input Power (P_{IN}), Pulsed, 50 Ω , $V_D = 24$ V, $I_{DQ} = 3.4$ A, $T_{BASE} = 85$ °C,	36 dBm
Input Power (P_{IN}), Pulsed, 3:1 VSWR, $V_D = 24$ V, $I_{DQ} = 3.4$ A, $T_{BASE} = 85$ °C	36 dBm
Mounting Temperature	Refer to Assembly Notes, page 22
Storage Temperature	-55 to +150 °C

Operation of this device outside the parameter ranges given above may cause permanent damage. These are stress ratings only, and functional operation of the device at these conditions is not implied.

Recommended Operating Conditions

Parameter	Min	Typ.	Max	Units
Drain Voltage (V_D)		+24	+24	V
Drain Current, Quiescent (I_{DQ})		3.4		A
Drain Current, RF (I_{D_Drive})	See chart page 4, 7			A
Gate Voltage Typ. Range (V_G)	-2 to -2.9			V
Gate Current, RF (I_{G_Drive})	See chart page 4, 7			mA
Operating Temp. Range (T_{BASE})	-40		+85	°C

Electrical specifications are measured at specified test conditions. Specifications are not guaranteed over all recommended operating conditions.

Electrical Specifications

Parameter	Conditions ^{(1) (2)}	Min	Typ.	Max	Units
Operational Frequency Range		5.7		7	GHz
Output Power at Saturation, P_{SAT}	$P_{IN} = +32$ dBm, Pulsed		50		dBm
Power Added Efficiency, PAE	$P_{IN} = +32$ dBm, Pulsed		35		%
Large Signal Gain	$P_{IN} = +32$ dBm, Pulsed		18		dB
Small Signal Gain, S_{21}	CW		24		dB
Input Return Loss, IRL	CW		18		dB
Output Return Loss, ORL	CW		20		dB
3 RD Intermodulation Products, IM3	$P_{OUT}/Tone = 43$ dBm; Freq. = 5.7, 6.4, 7 GHz; $\Delta f = 5$ MHz, CW		-25		dBc
5 TH Intermodulation Products, IM5	$P_{OUT}/Tone = 43$ dBm; Freq. = 35 GHz; $\Delta f = 5$ MHz, CW		-35		dBc
P_{SAT} Temperature Coefficient	$T_{DIFF} = -40$ °C to +85 °C; $P_{IN} = +26$ dBm, Pulsed		-0.007		dBm/°C
S_{21} Temperature Coefficient	$T_{DIFF} = -40$ °C to +85 °C, CW		-0.065		dB/°C
Gate Leakage, I_G	$V_D = +10$ V, $V_G = -4$ V, no RF	-70.4		0.01	mA

Notes:

- Test conditions unless otherwise noted: Pulsed $V_D = +24$ V, $I_{DQ} = 3.4$ A, $V_G = -2.5$ V +/- typical, DC = 20%, PW = 150 us, $T_{BASE} = +25$ °C, $Z_0 = 50$ Ω
- T_{BASE} is back side of QPM1017

Performance Plots – Large Signal

Test conditions, unless otherwise noted: **Pulsed** $V_D = 24\text{ V}$, $I_{DQ} = 3.4\text{ A}$, Duty Cycle = 20%, $PW = 150\text{ }\mu\text{s}$, $P_{IN} = 32\text{ dBm}$, $T_{BASE} = +25\text{ }^\circ\text{C}$

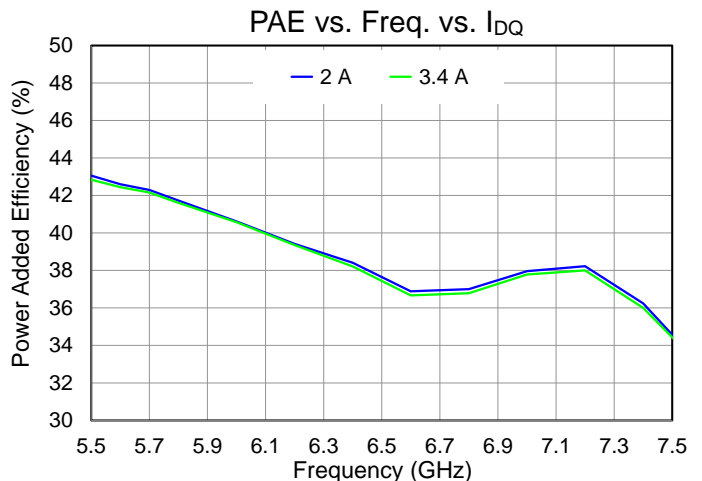
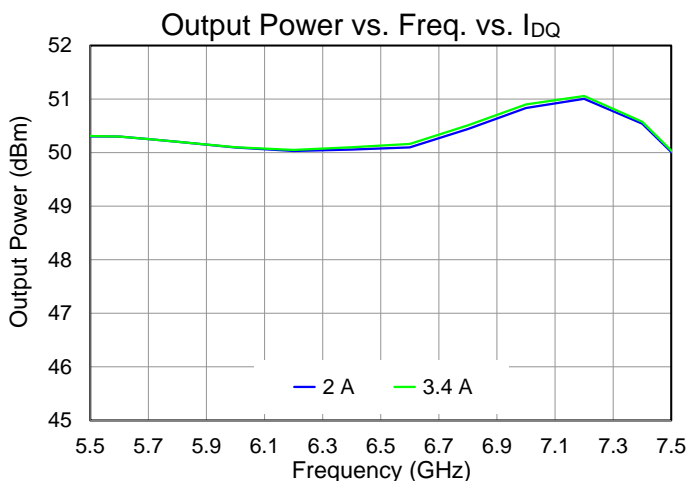
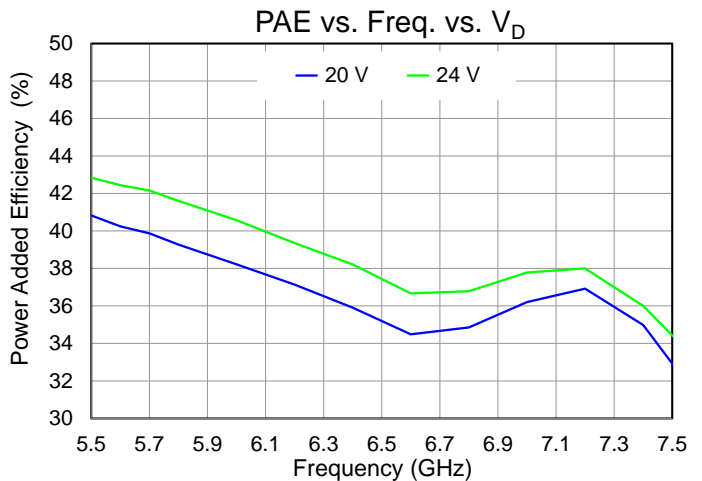
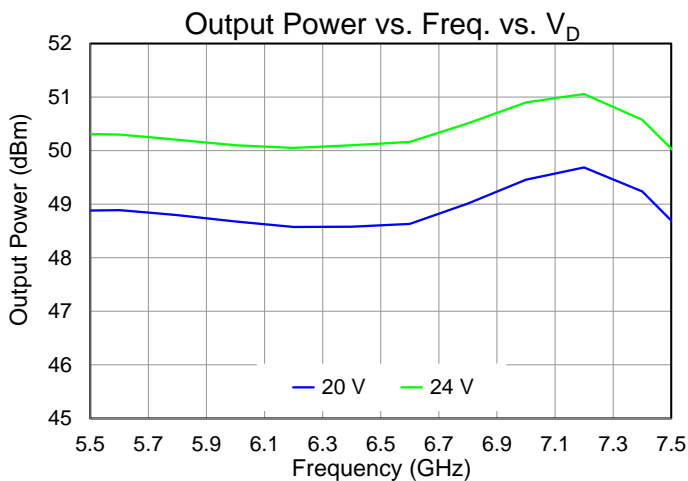
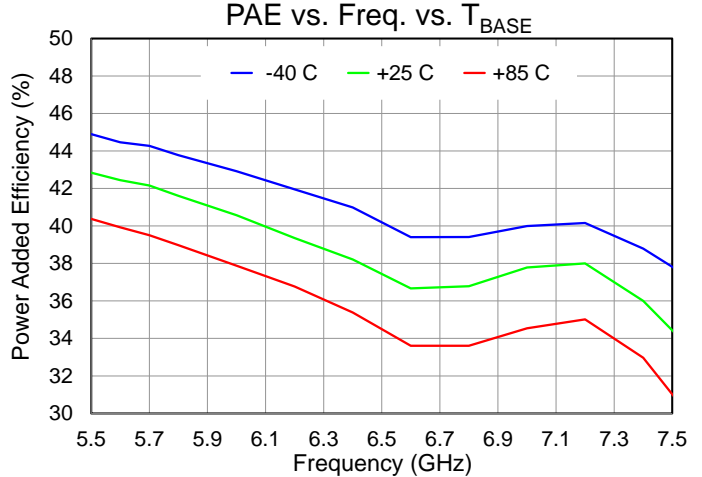
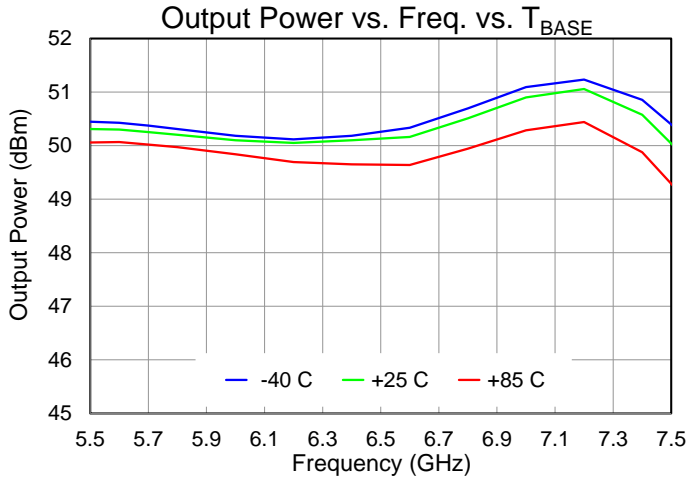

Performance Plots – Large Signal

Test conditions, unless otherwise noted: **Pulsed** $V_D = 24\text{ V}$, $I_{DQ} = 3.4\text{ A}$, Duty Cycle = 20%, $PW = 150\text{ us}$, $P_{IN} = 32\text{ dBm}$, $T_{BASE} = +25\text{ }^\circ\text{C}$

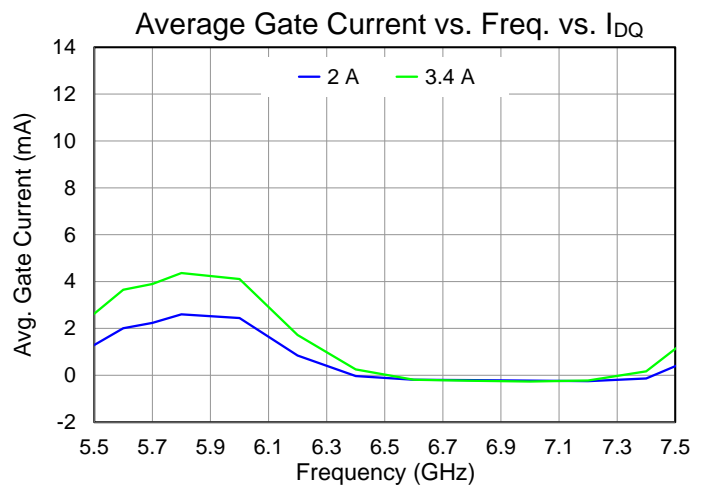
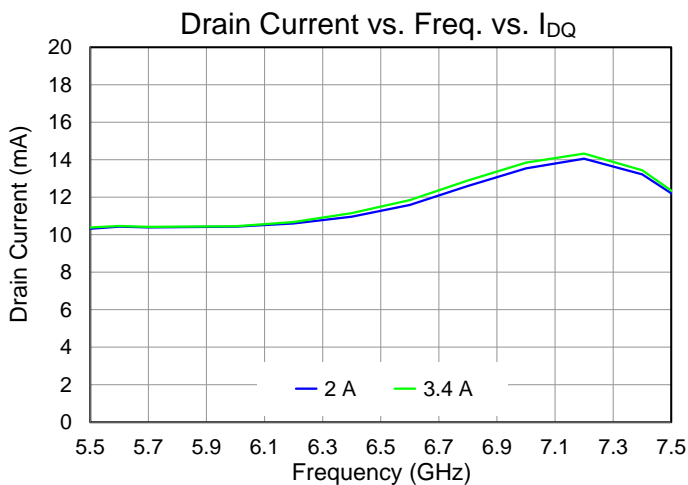
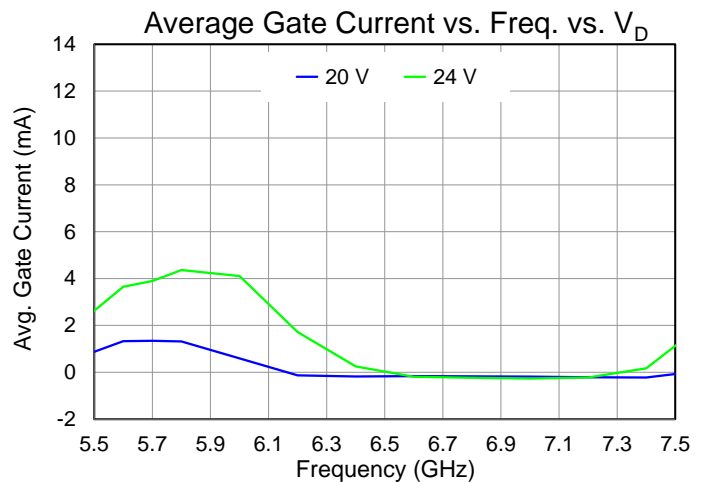
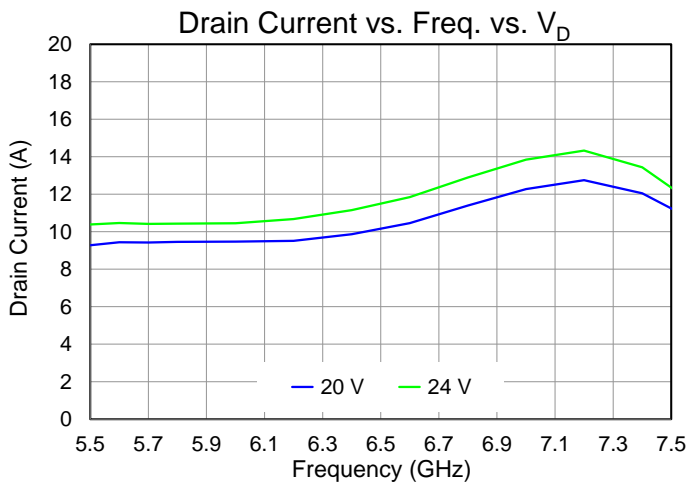
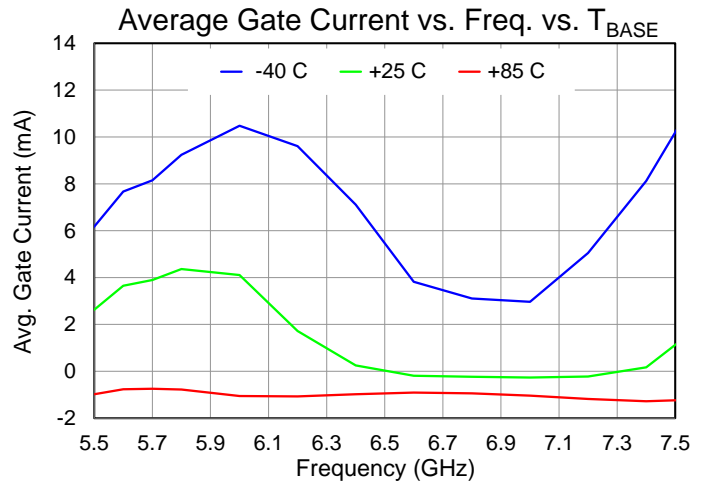
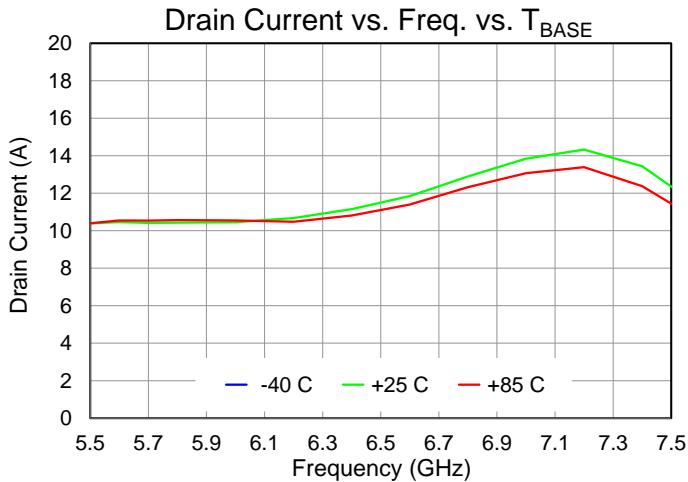

Performance Plots – Large Signal

Test conditions, unless otherwise noted: Pulsed $V_D = 24\text{ V}$, $I_{DQ} = 3.4\text{ A}$, Duty Cycle = 20%, $P_{IN} = 32\text{ dBm}$, $T_{BASE} = +25\text{ }^\circ\text{C}$

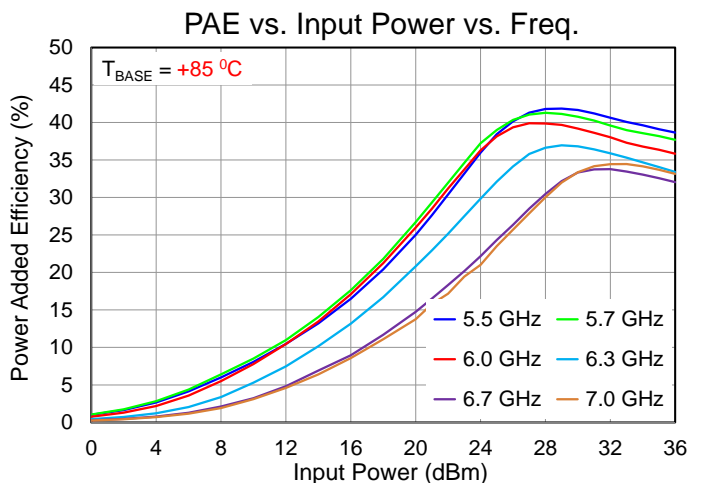
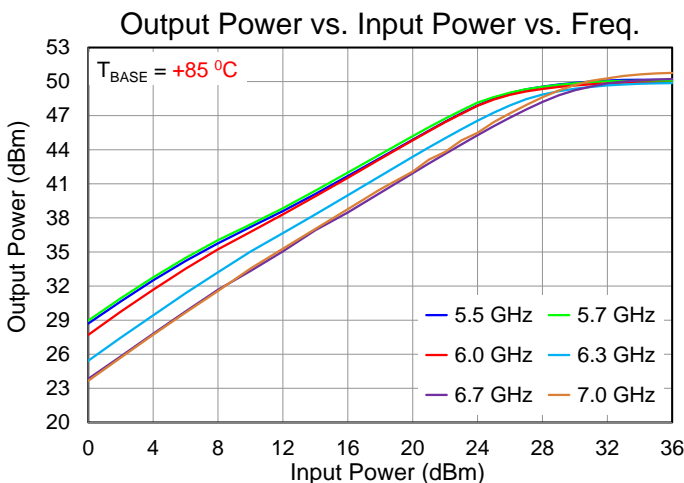
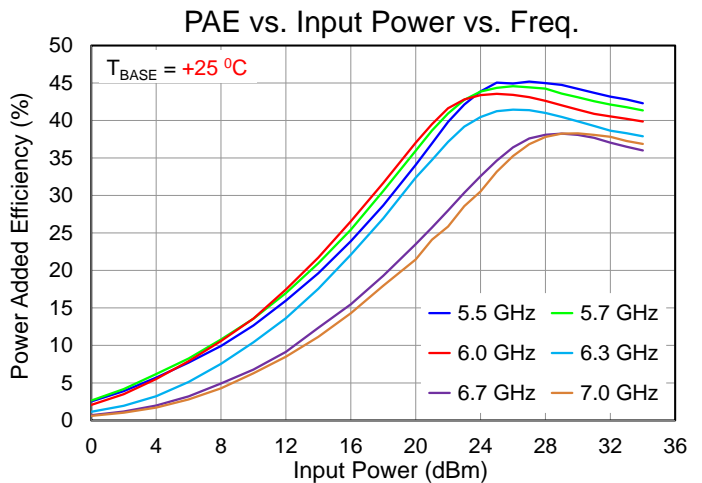
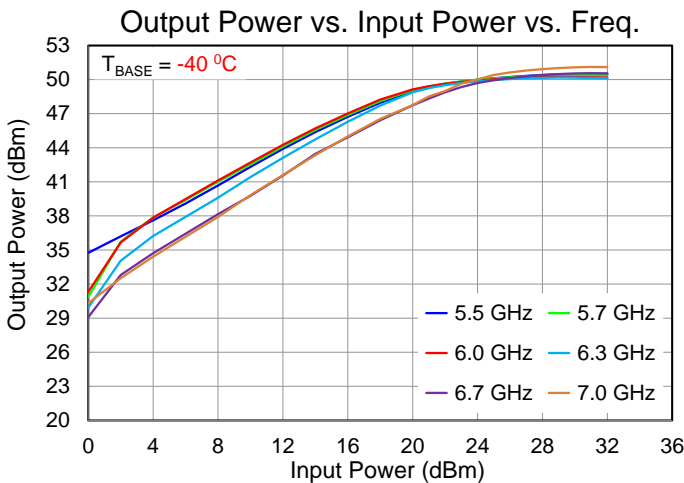
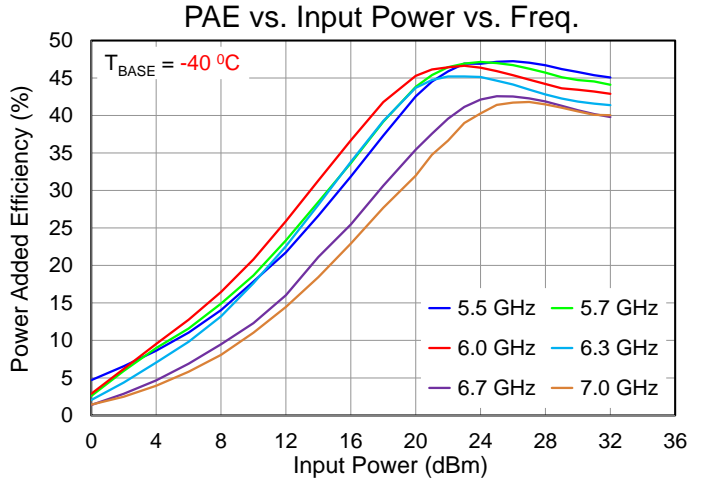
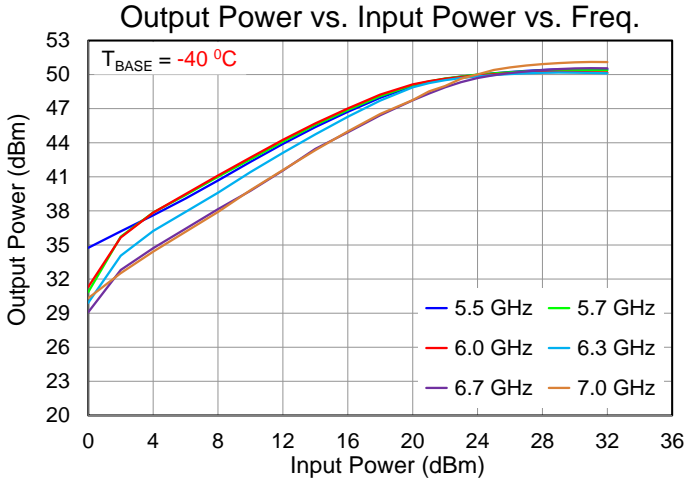

Performance Plots – Large Signal

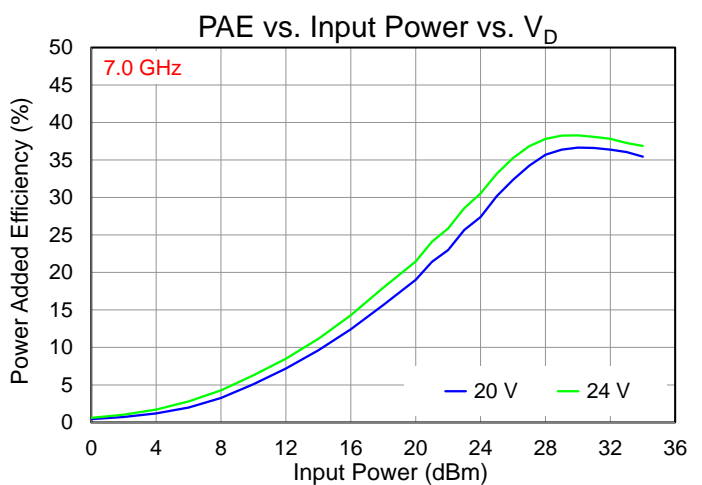
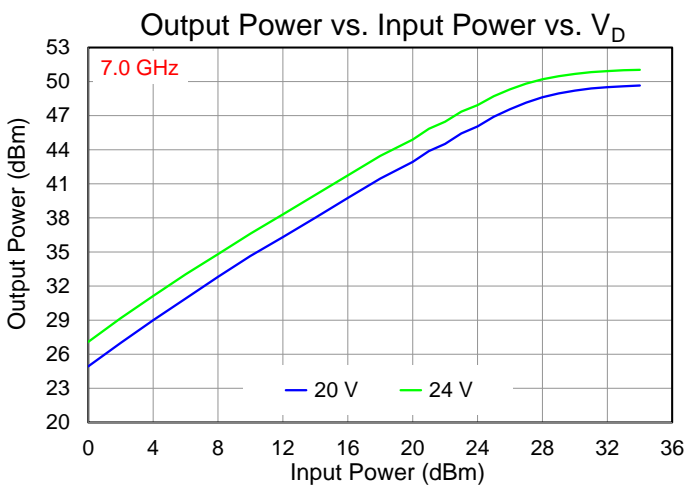
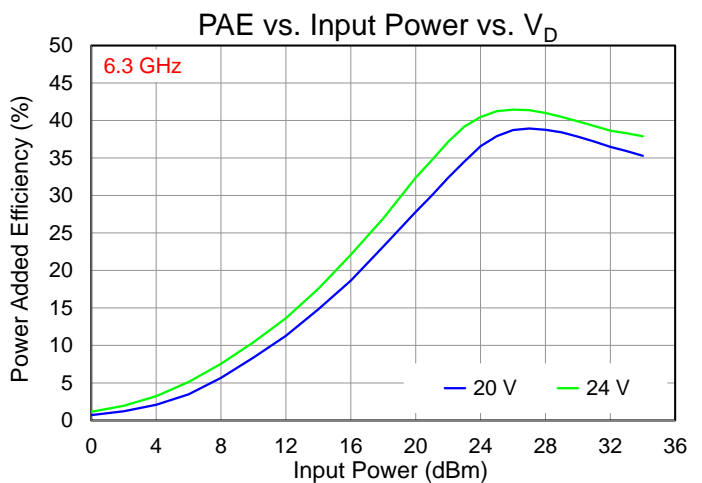
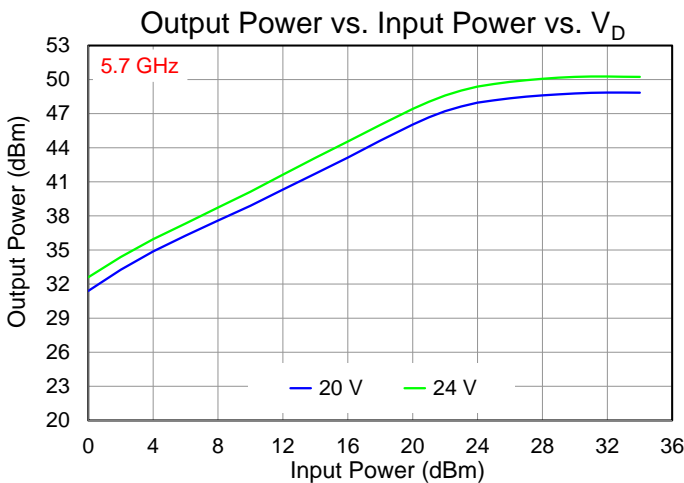
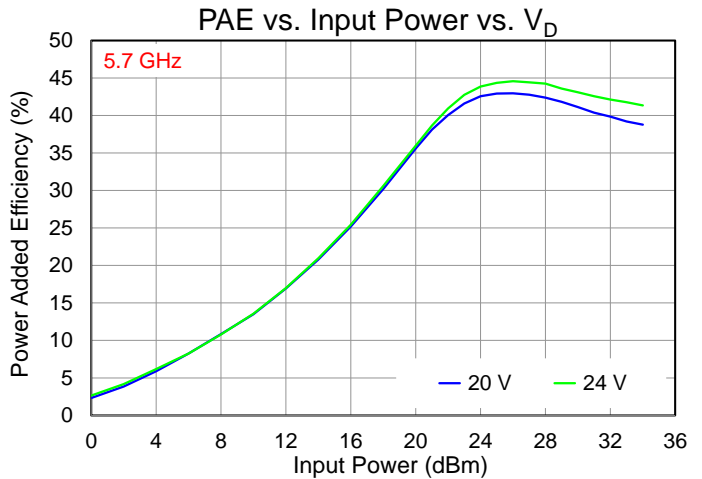
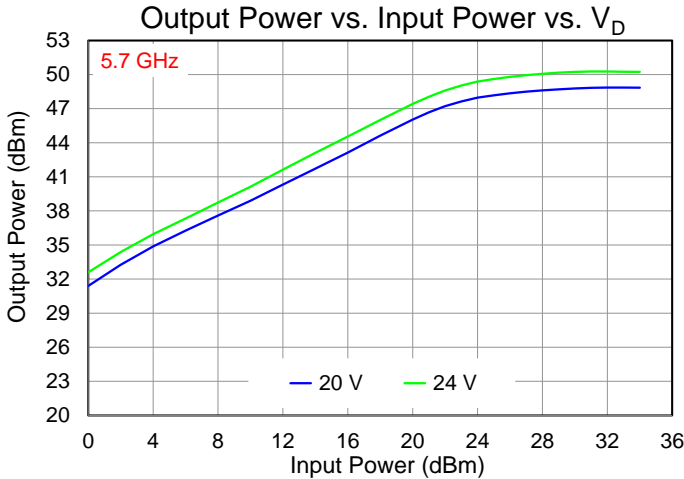
 Test conditions, unless otherwise noted: **Pulsed** $V_D = 24\text{ V}$, $I_{DQ} = 3.4\text{ A}$, Duty Cycle = 20%, $P_{IN} = 32\text{ dBm}$, $T_{BASE} = +25\text{ }^\circ\text{C}$

Performance Plots – Large Signal

Test conditions, unless otherwise noted: Pulsed $V_D = 24\text{ V}$, $I_{DQ} = 3.4\text{ A}$, Duty Cycle = 20%, $P_{IN} = 32\text{ dBm}$, $T_{BASE} = +25\text{ }^\circ\text{C}$

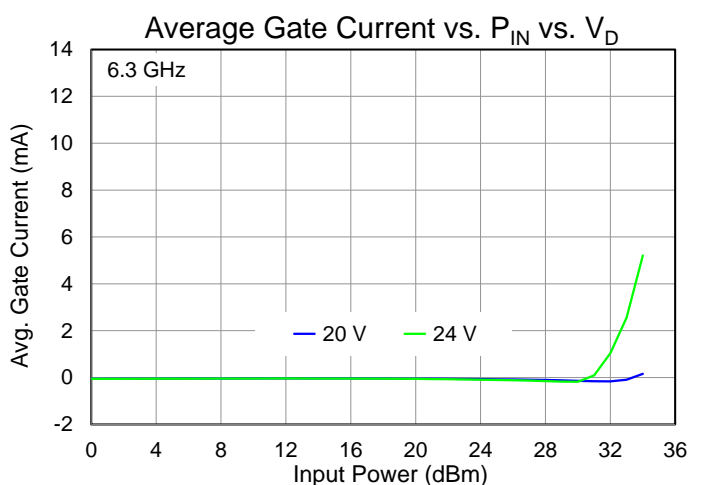
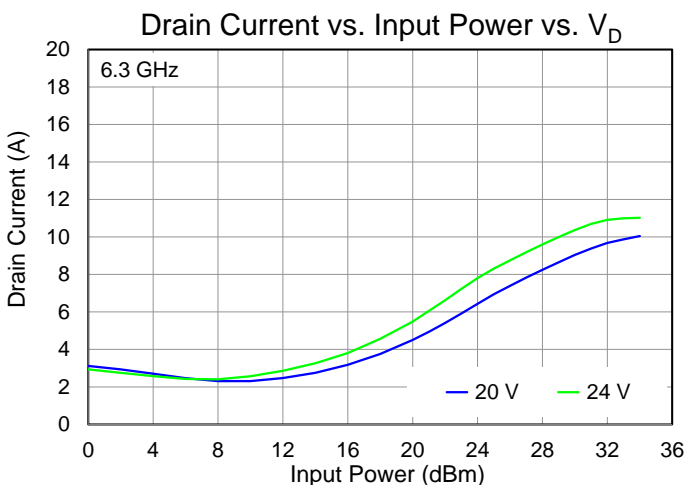
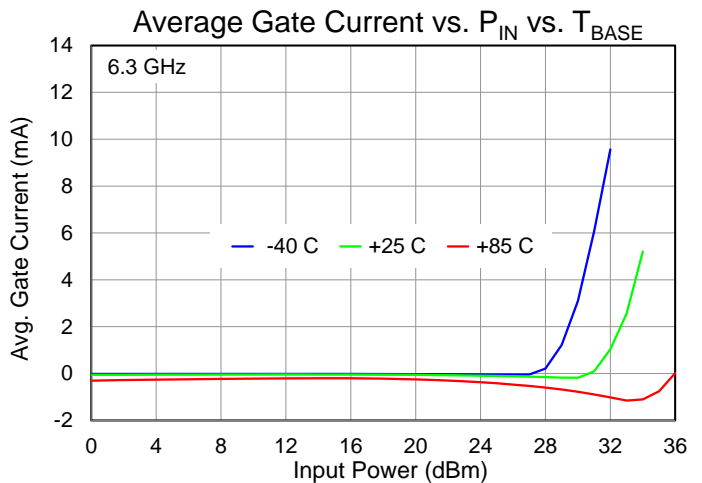
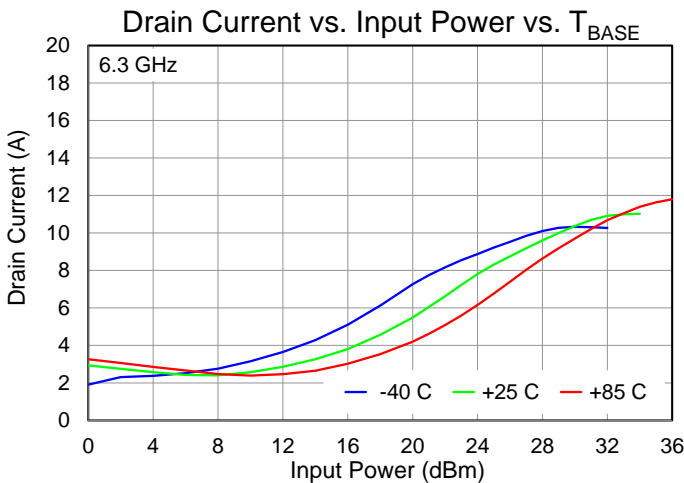
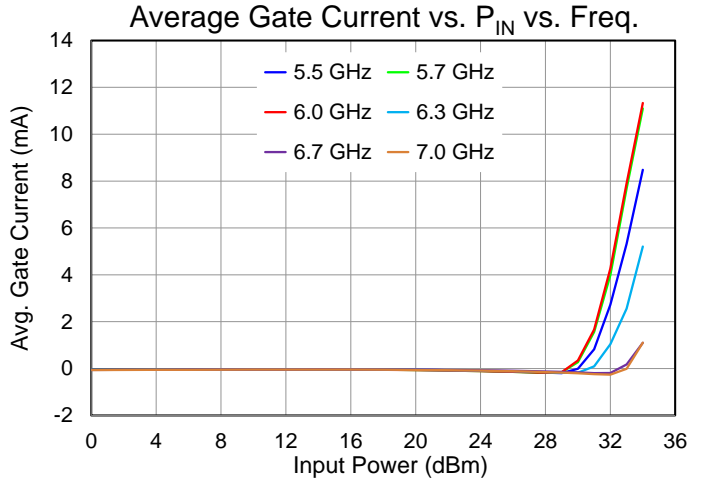
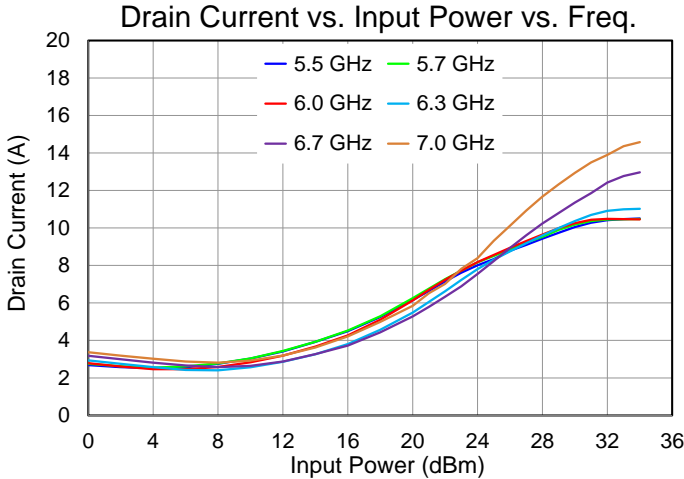

Performance Plots – Large Signal

Test conditions, unless otherwise noted: Pulsed $V_D = 24\text{ V}$, $I_{DQ} = 3.4\text{ A}$, Duty Cycle = 20%, $PW = 150\text{ }\mu\text{s}$, $P_{IN} = 32\text{ dBm}$, $T_{BASE} = +25\text{ }^\circ\text{C}$

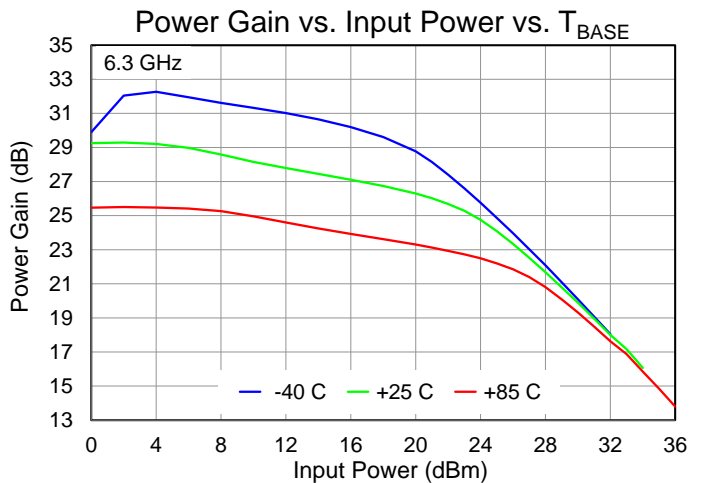
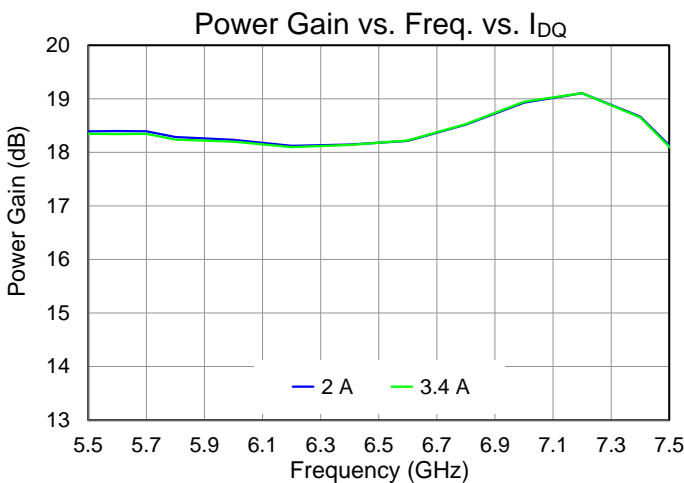
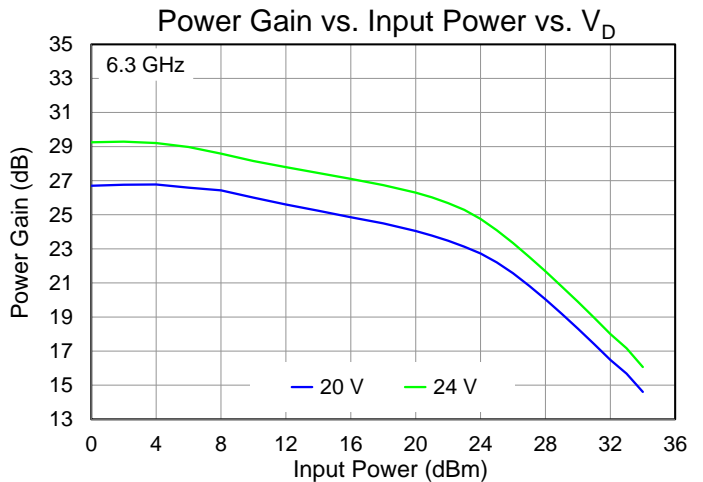
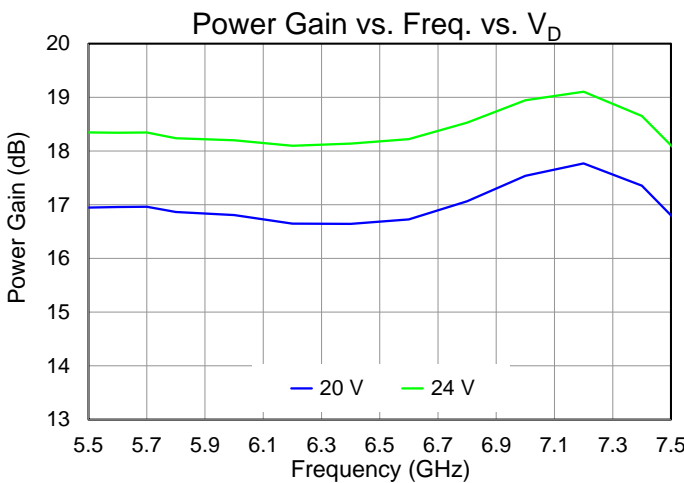
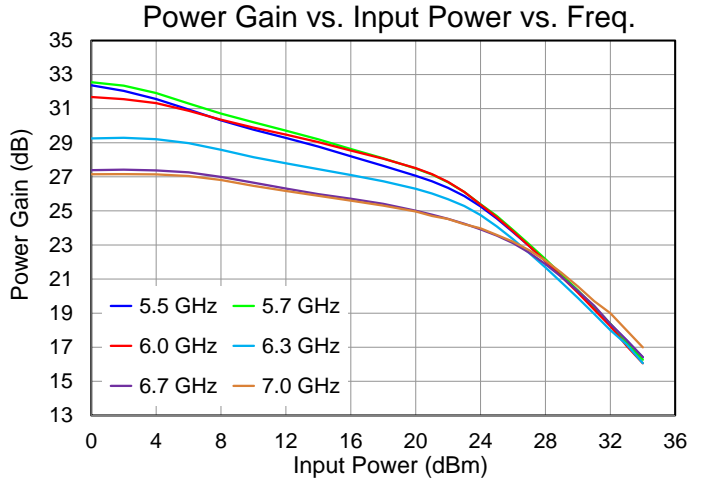
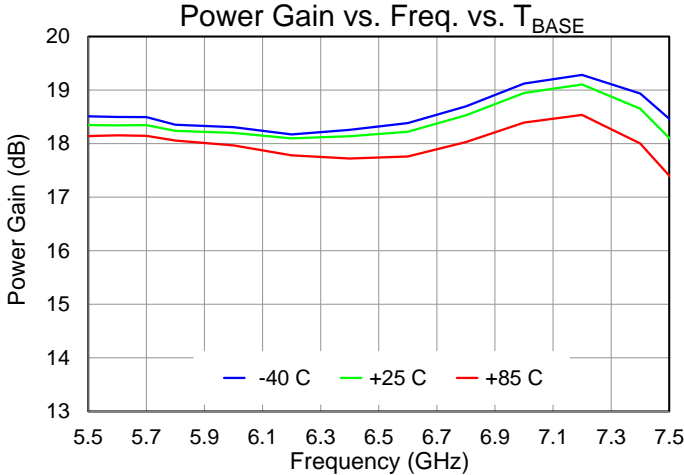

Performance Plots – Large Signal

Test conditions, unless otherwise noted: CW $V_D = 24\text{ V}$, $I_{DQ} = 3.4\text{ A}$, Tone Spacing = 5 MHz, $T_{BASE} = +25\text{ }^\circ\text{C}$, with/without 10uF at drain (C9, C12)

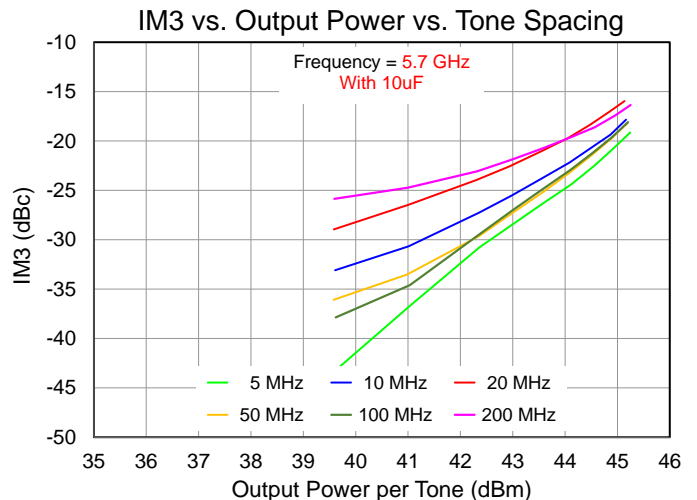
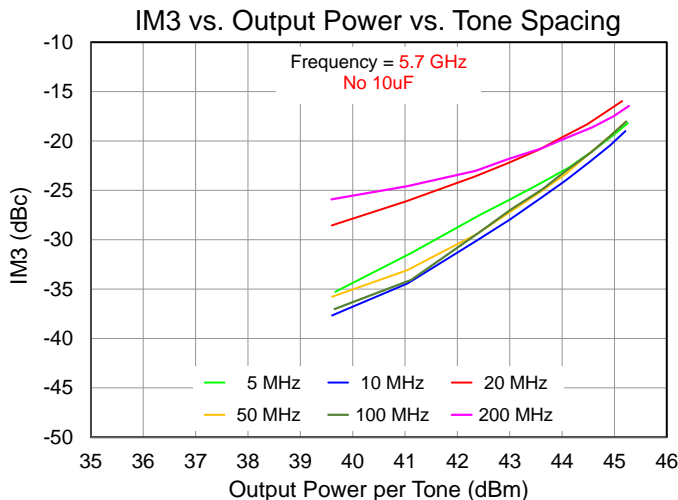
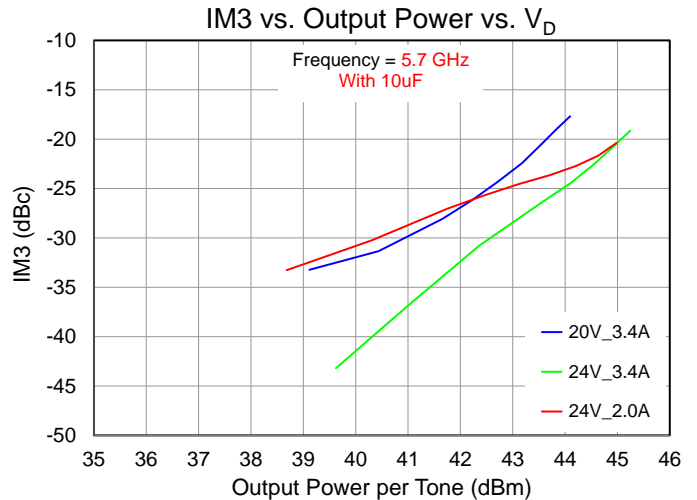
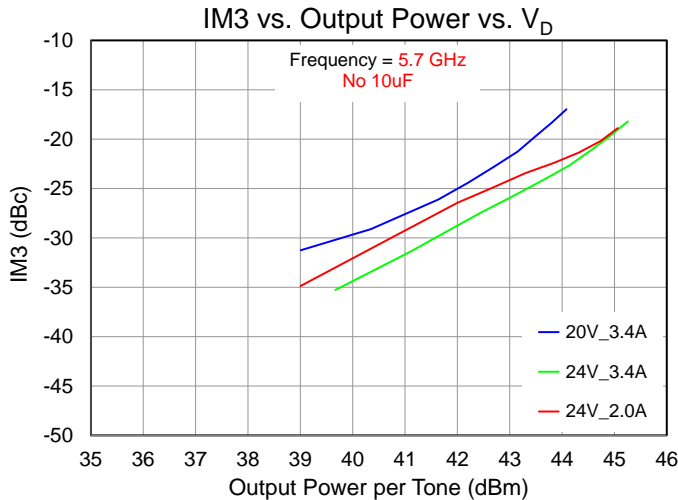
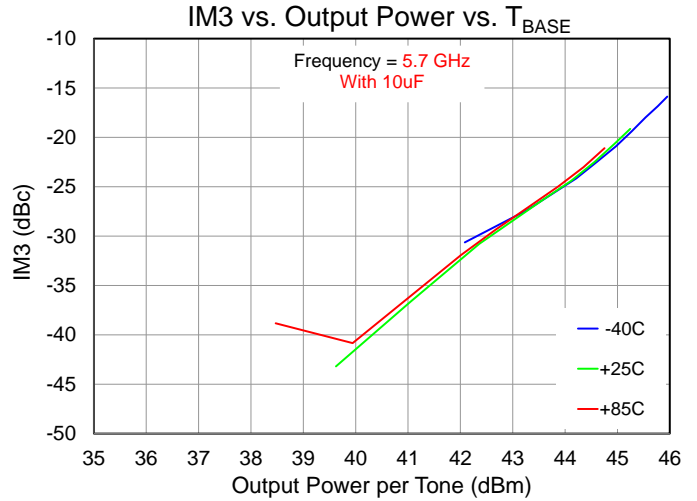
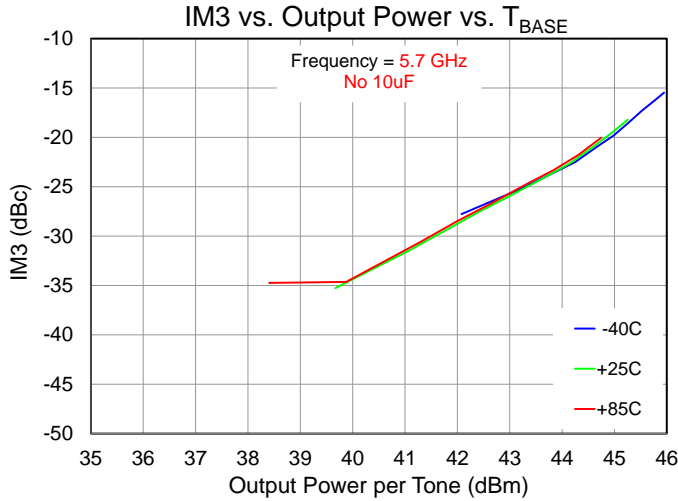

Performance Plots – Large Signal

Test conditions, unless otherwise noted: CW $V_D = 24\text{ V}$, $I_{DQ} = 3.4\text{ A}$, Tone Spacing = 5 MHz, $T_{BASE} = +25\text{ }^\circ\text{C}$, with/without 10uF at drain (C9, C12)

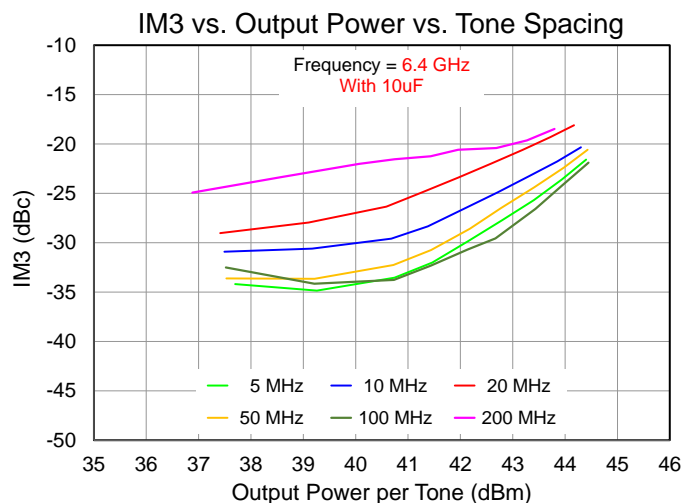
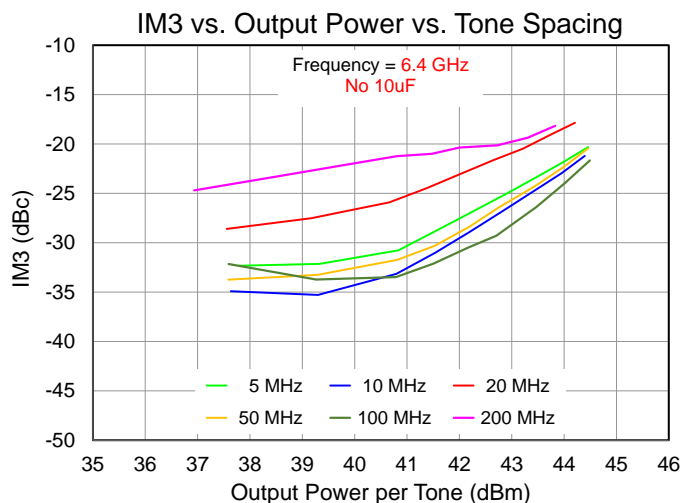
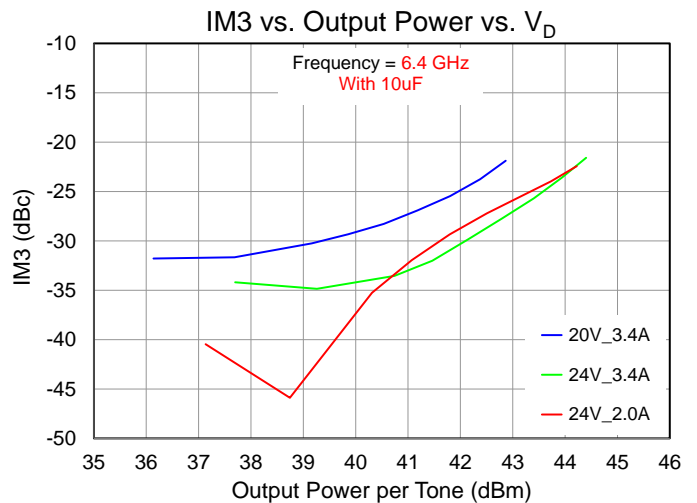
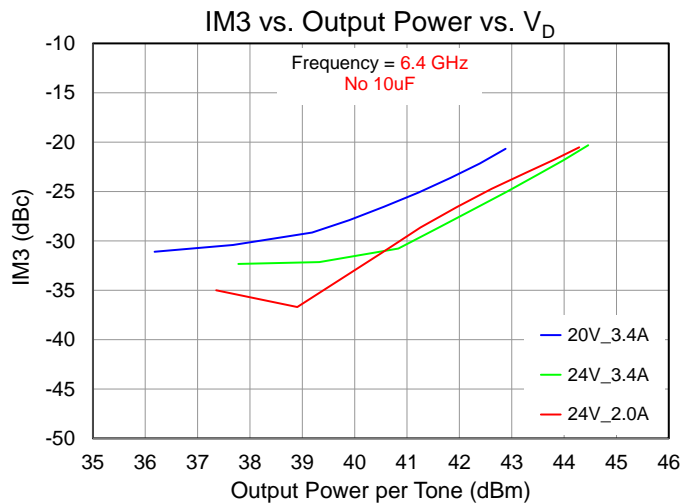
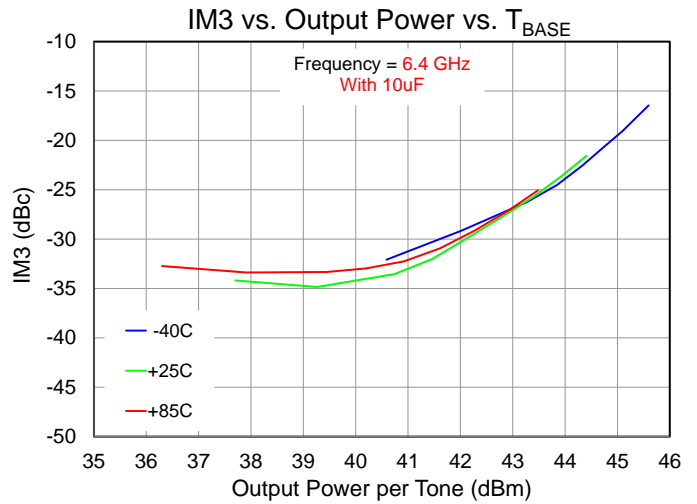
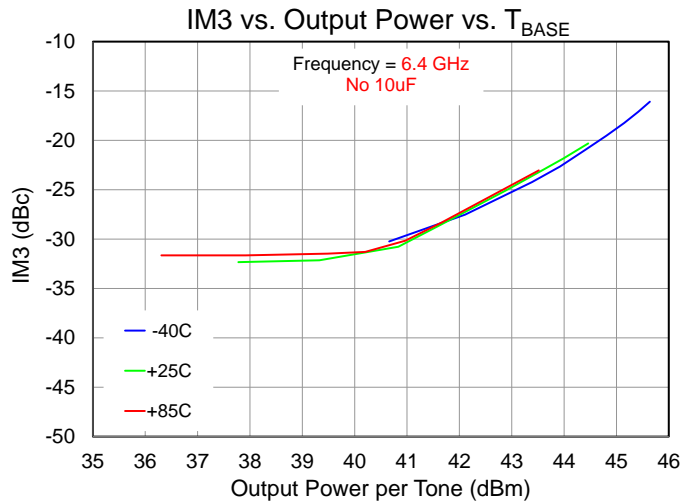

Performance Plots – Large Signal

Test conditions, unless otherwise noted: CW $V_D = 24\text{ V}$, $I_{DQ} = 3.4\text{ A}$, Tone Spacing = 5 MHz, $T_{BASE} = +25\text{ }^\circ\text{C}$, with/without 10uF at drain (C9, C12)

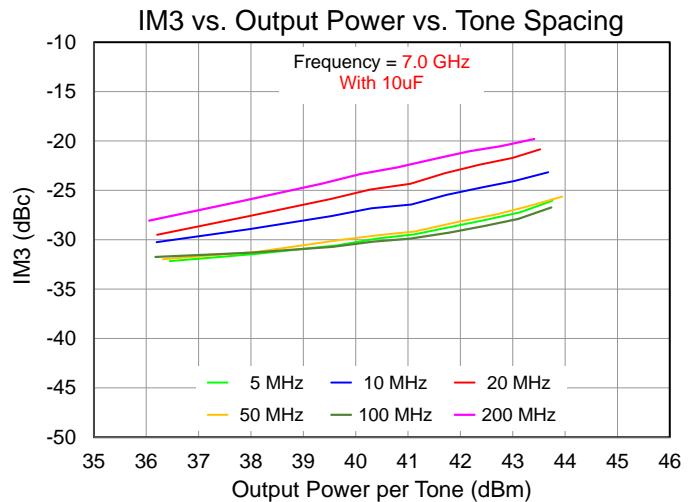
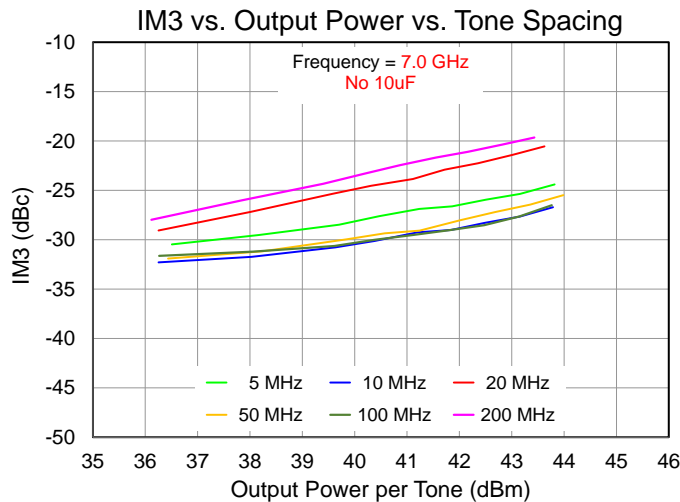
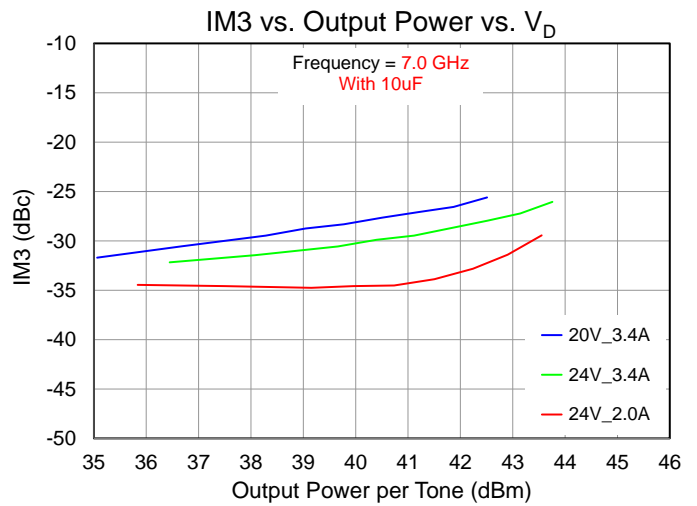
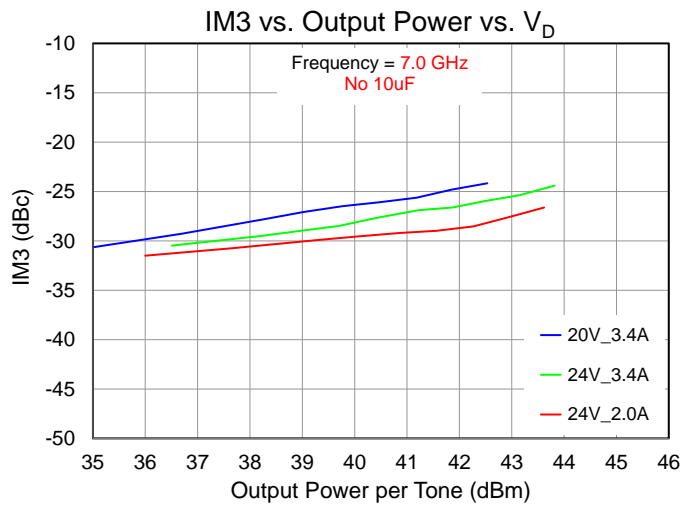
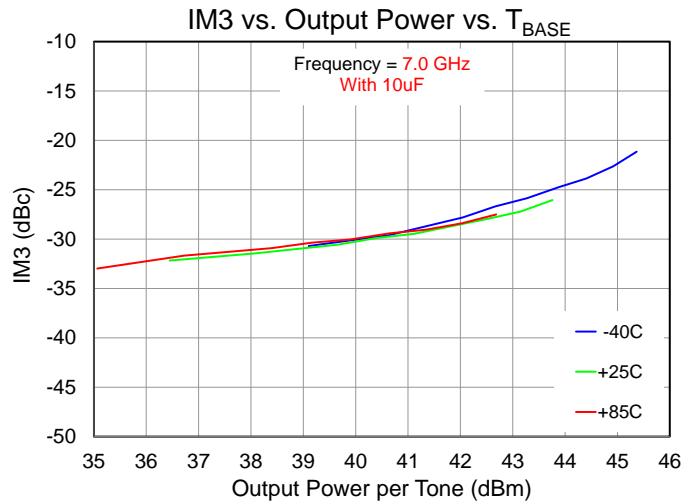
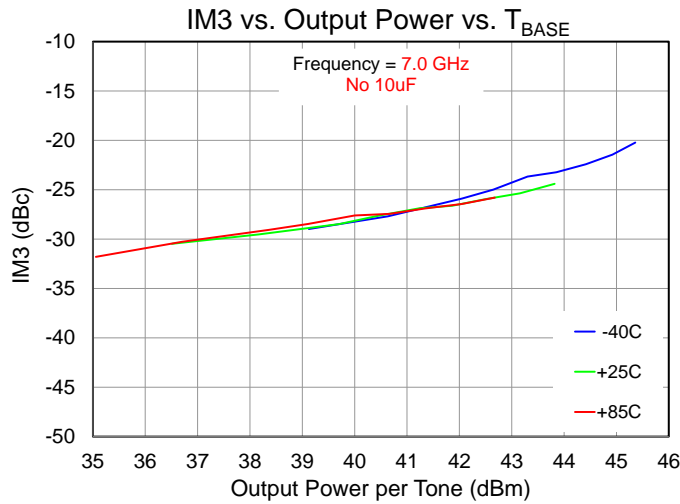

Performance Plots – Linearity

Test conditions, unless otherwise noted: CW $V_D = 24\text{ V}$, $I_{DQ} = 3.4\text{ A}$, Tone Spacing = 5 MHz, $T_{BASE} = +25\text{ }^\circ\text{C}$, with/without 10uF at drain (C9, C12)

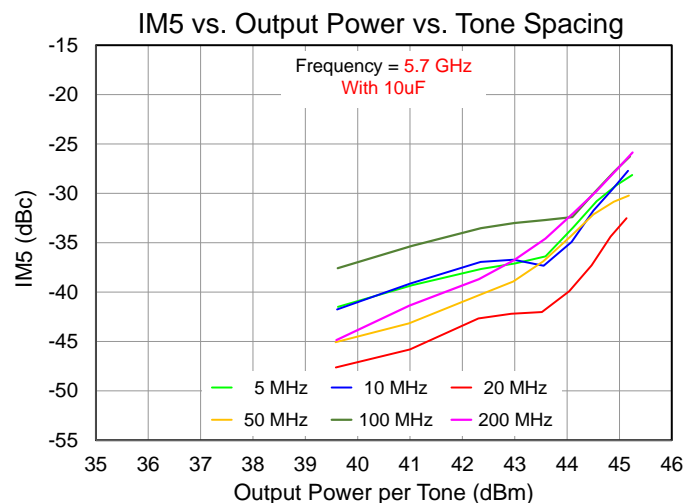
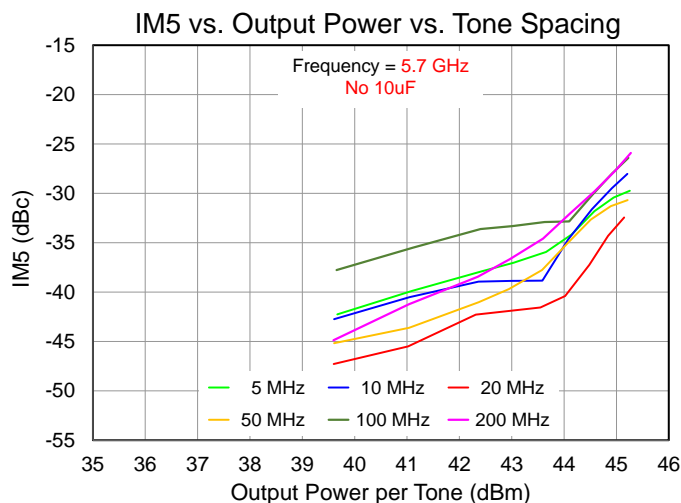
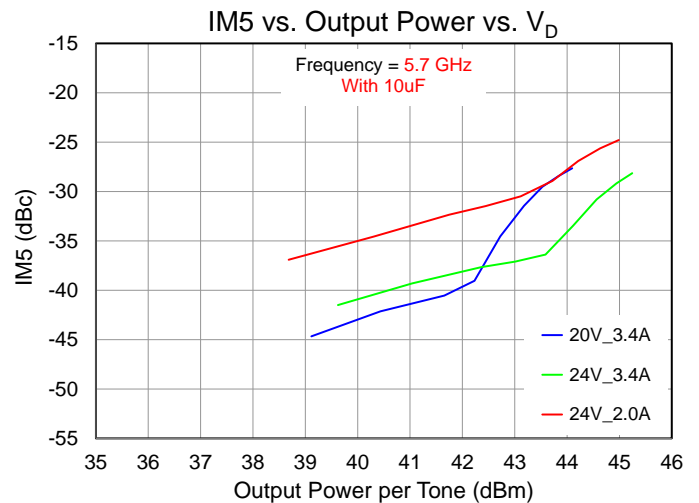
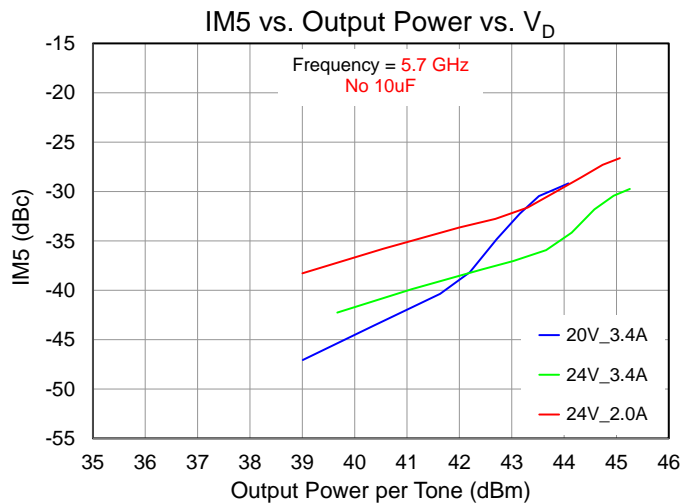
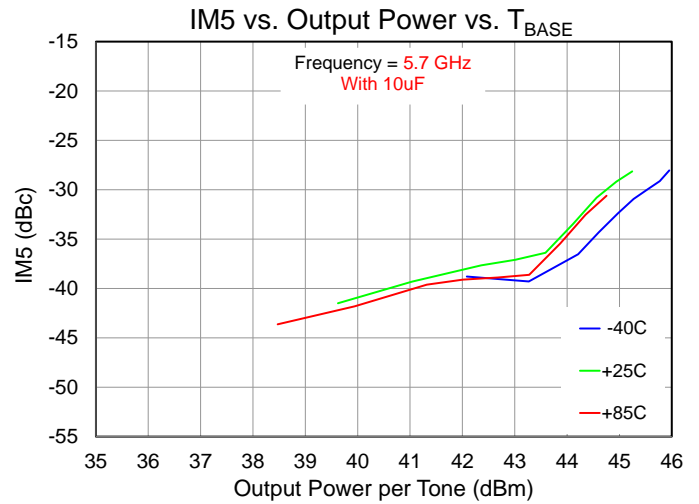
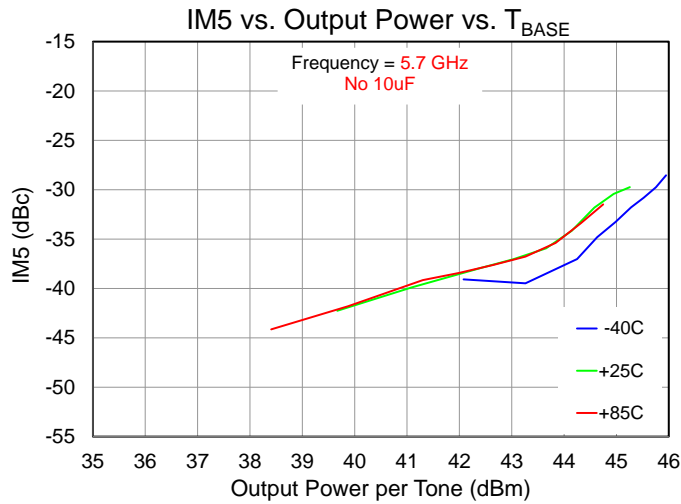

Performance Plots – Linearity

Test conditions, unless otherwise noted: CW $V_D = 24\text{ V}$, $I_{DQ} = 3.4\text{ A}$, Tone Spacing = 5 MHz, $T_{BASE} = +25\text{ }^\circ\text{C}$, with/without 10uF at drain (C9, C12)

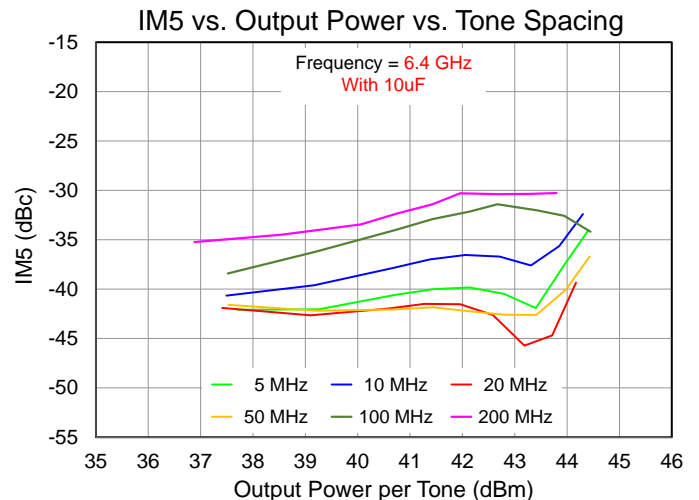
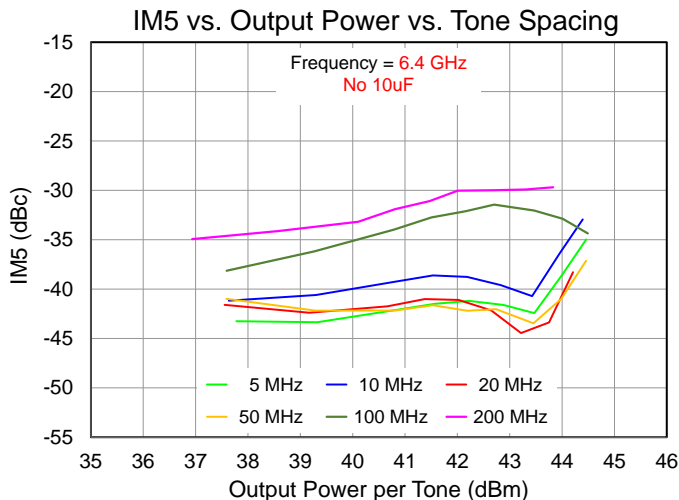
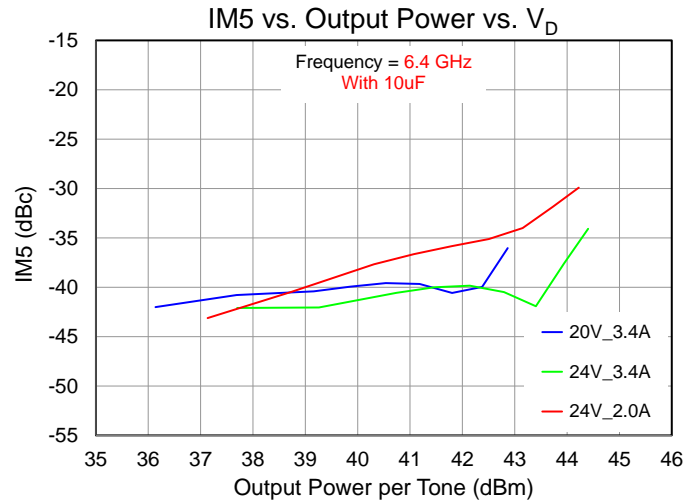
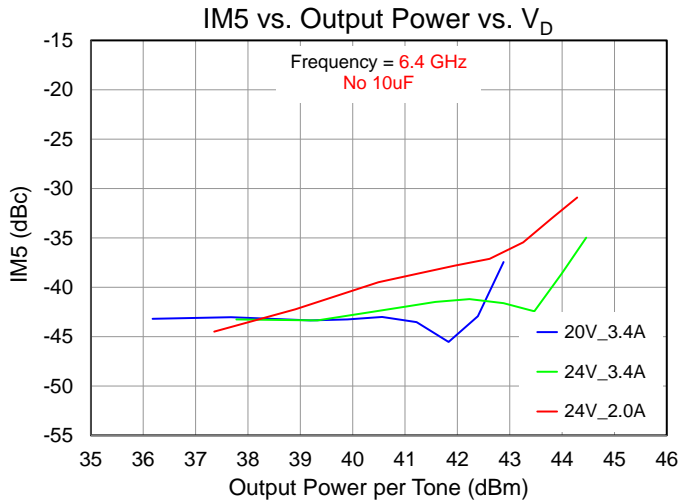
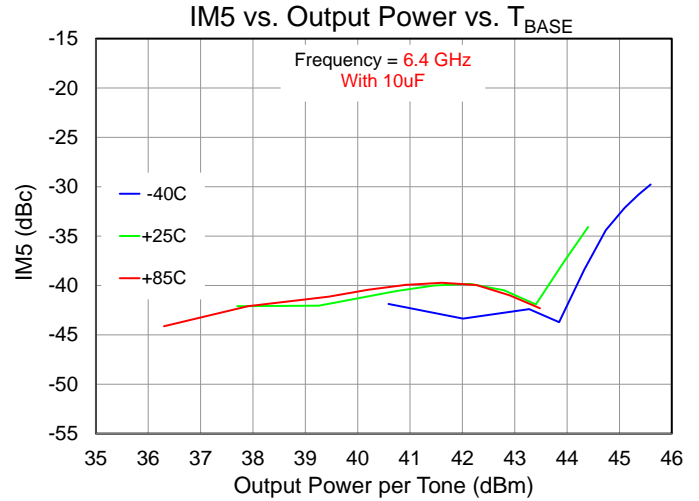
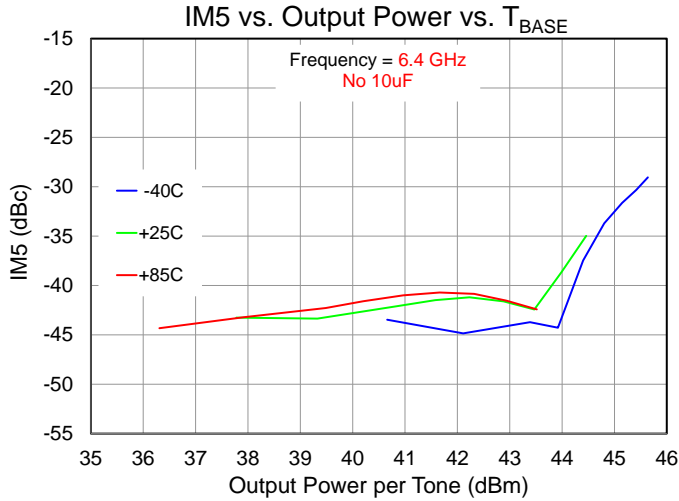

Performance Plots – Linearity

Test conditions, unless otherwise noted: CW $V_D = 24\text{ V}$, $I_{DQ} = 3.4\text{ A}$, Tone Spacing = 5 MHz, $T_{BASE} = +25\text{ }^\circ\text{C}$, with/without 10uF at drain (C9, C12)

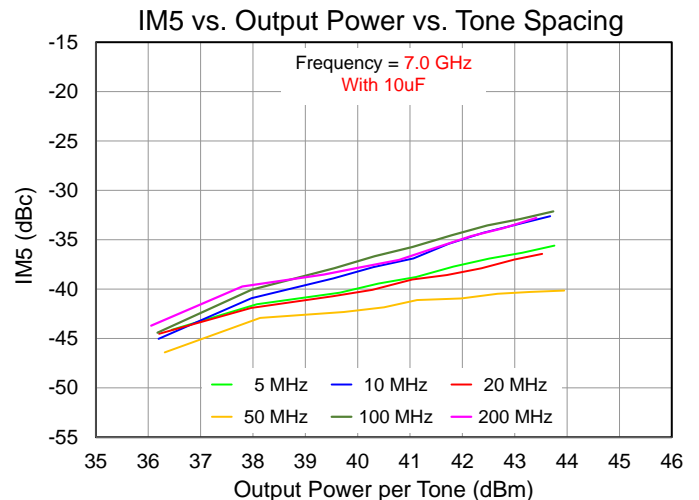
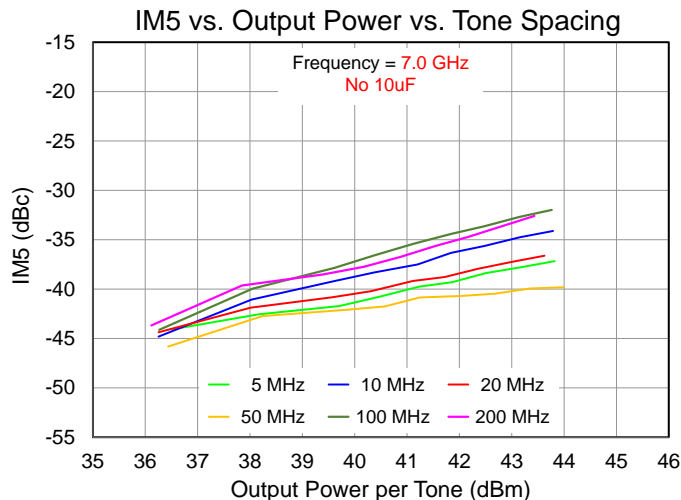
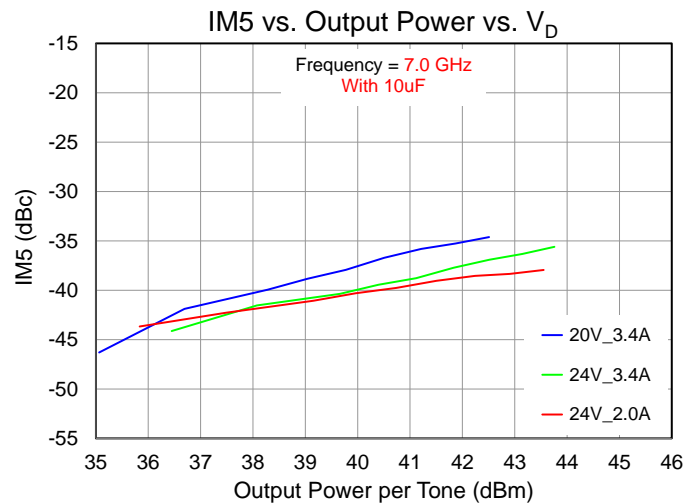
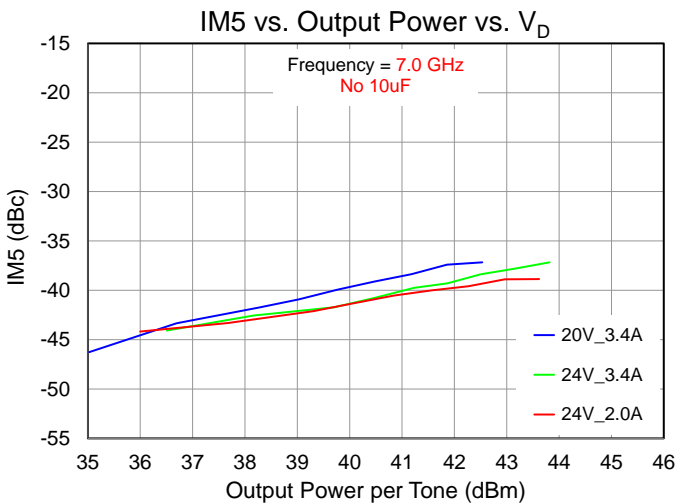
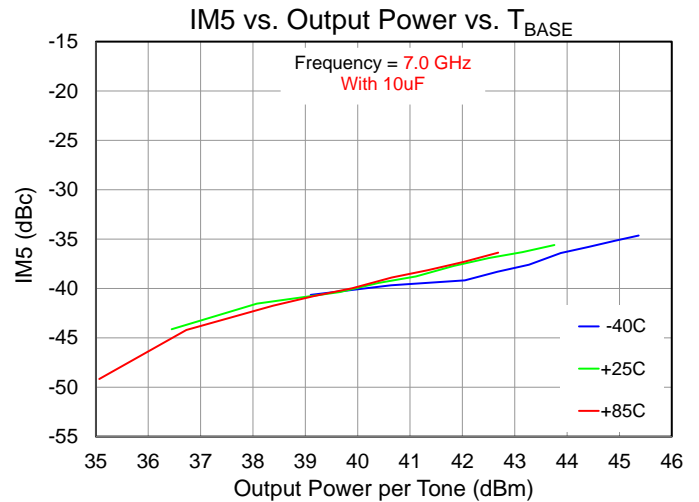
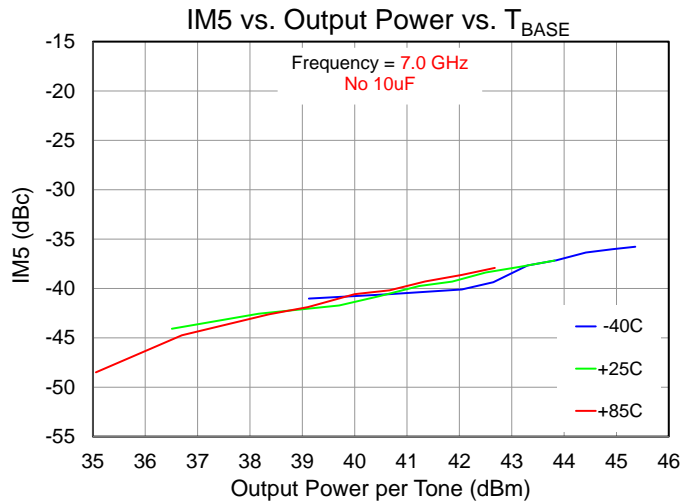

Performance Plots – Harmonics

Test conditions, unless otherwise noted: Pulsed $V_D = 24\text{ V}$, $I_{DQ} = 3.4\text{ A}$, Duty Cycle = 20%, $PW = 150\text{ }\mu\text{s}$, $T_{BASE} = +25\text{ }^\circ\text{C}$

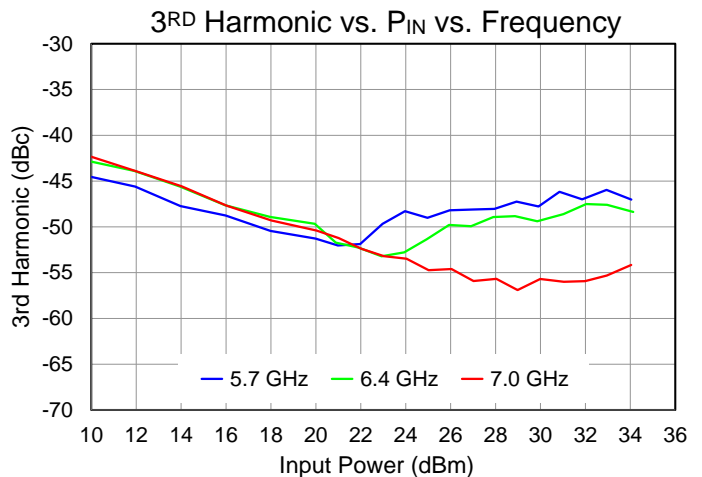
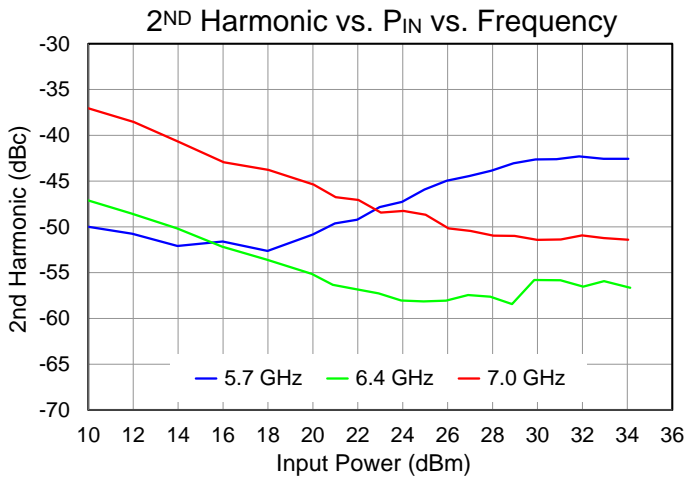
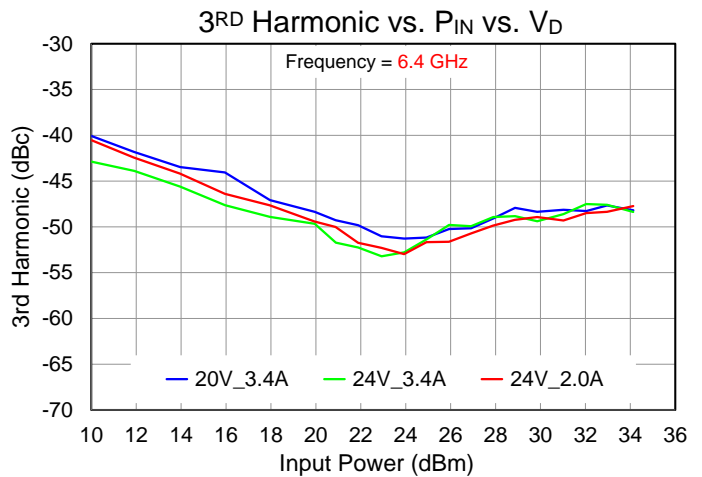
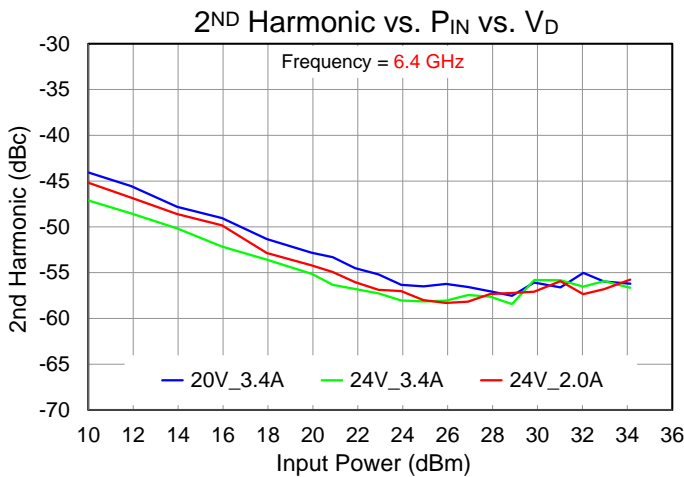
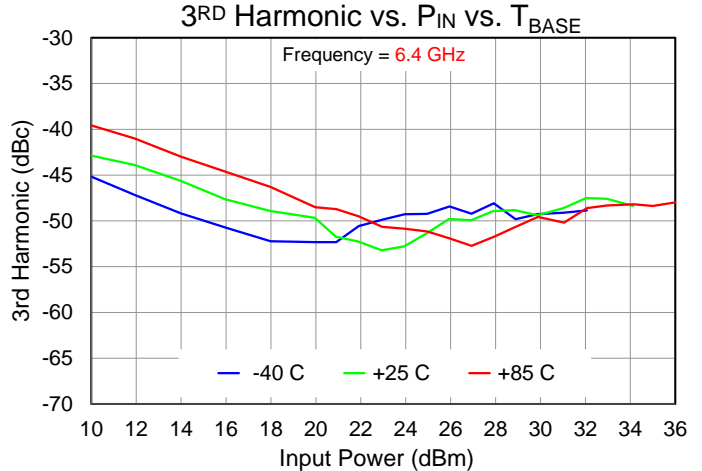
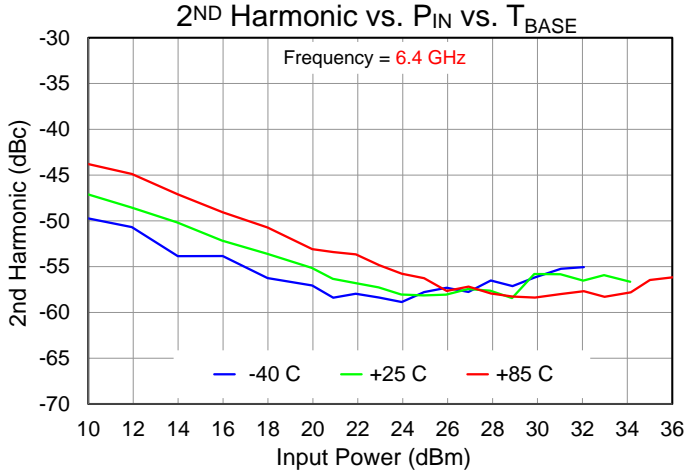

Performance Plots – Small Signal

Test conditions, unless otherwise noted: CW $V_D = 24$ V, $I_{DQ} = 3.4$ A, $T_{BASE} = +25$ °C

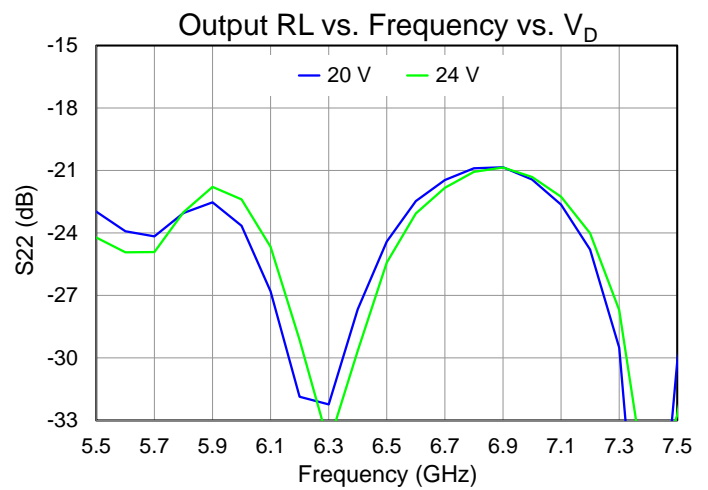
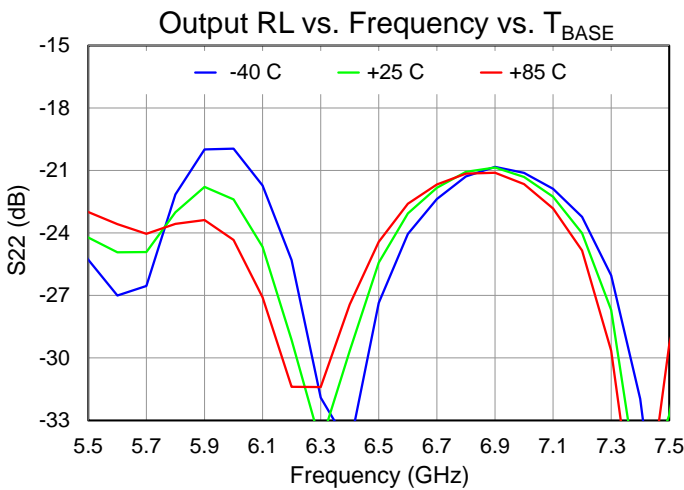
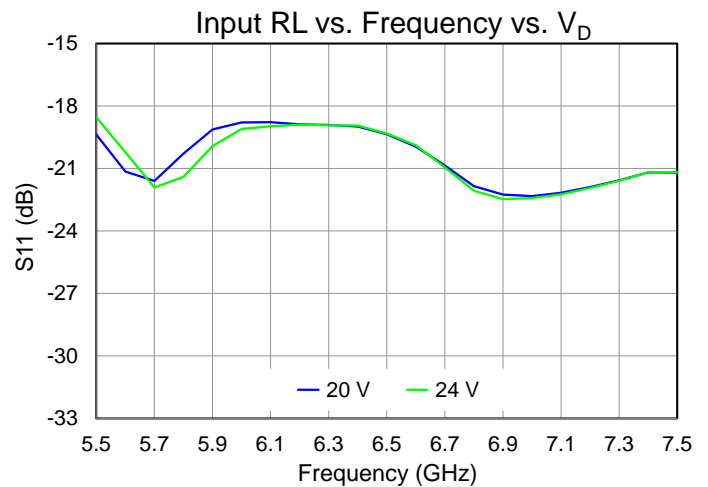
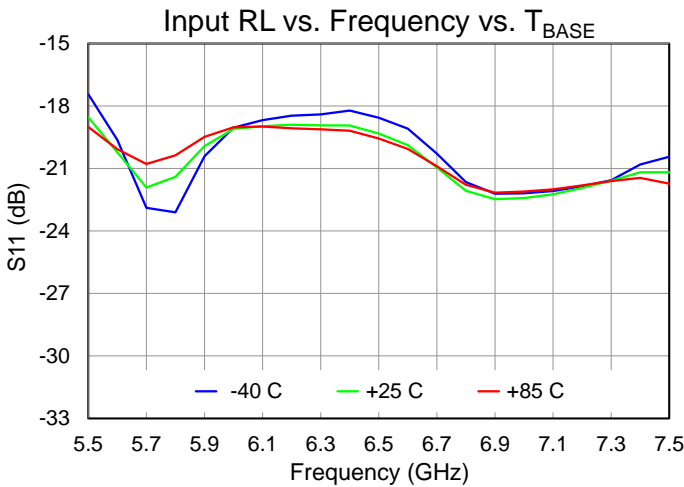
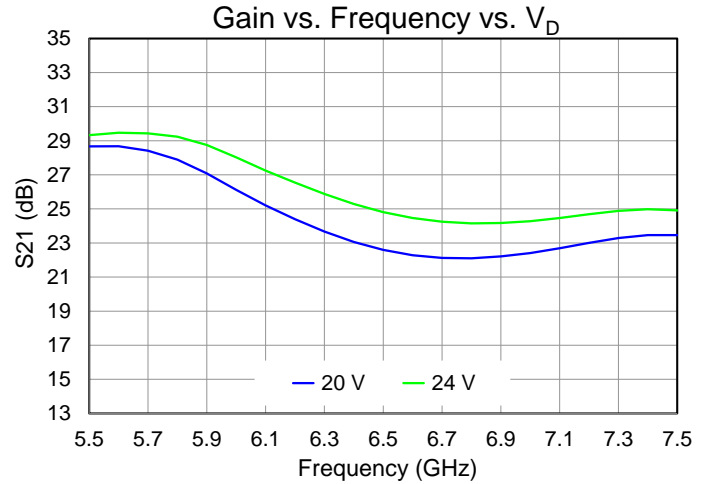
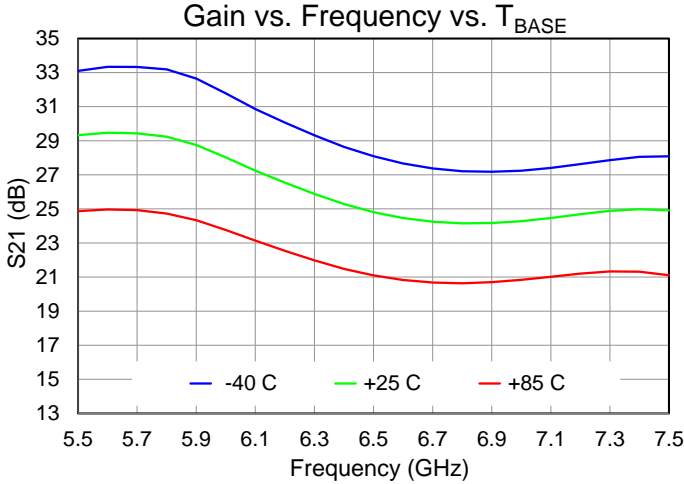

Performance Plots – Small Signal

Test conditions, unless otherwise noted: CW $V_D = 24$ V, $I_{DQ} = 3.4$ A, $T_{BASE} = +25$ °C

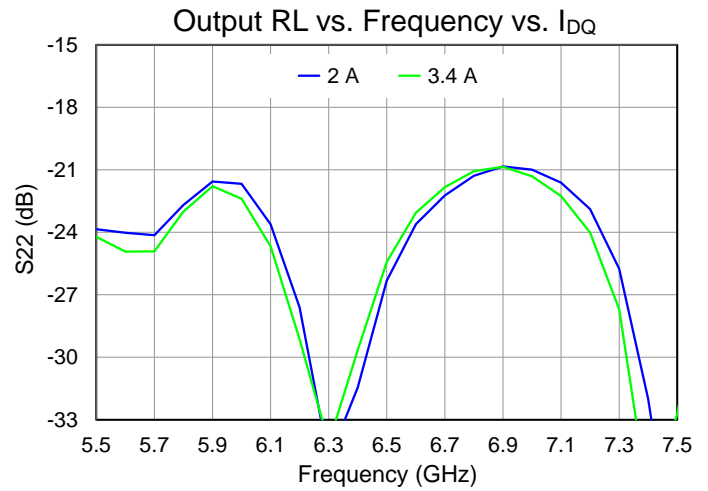
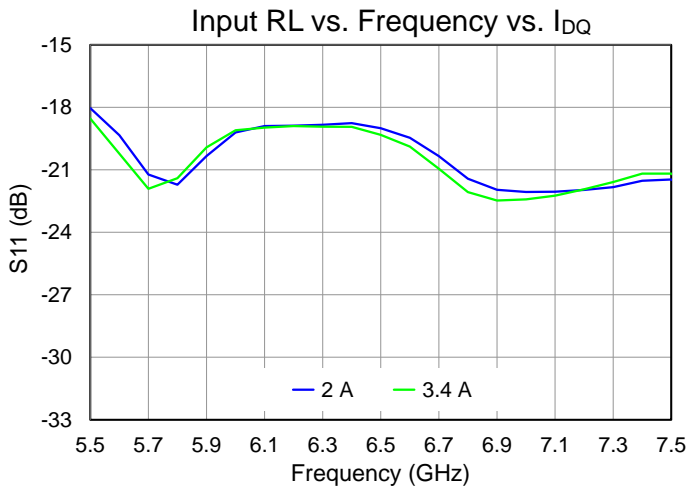
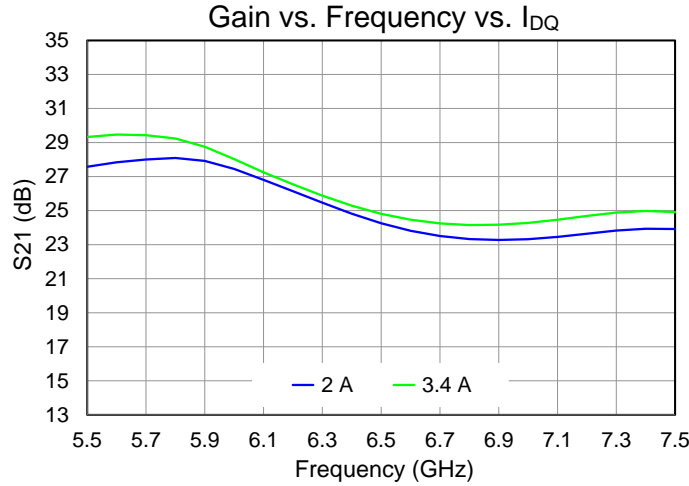

Thermal and Reliability Information

Parameter	Test Conditions	Value	Units
Thermal Resistance, θ_{JC} ⁽¹⁾	Quiescent	0.40	°C/W
Channel Temperature, T_{CH} ⁽²⁾	$T_{base} = 85\text{ °C}$, $V_D = 24\text{ V}$, $I_{DQ} = 3.4\text{ A}$ $P_{DISS} = 81.6\text{ W}$	118	°C
Thermal Resistance, θ_{JC} ⁽¹⁾	Pulsed , $T_{base} = 85\text{ °C}$, $V_D = 24\text{ V}$, $I_{DQ} = 3.4\text{ A}$, Freq = 7 GHz, $I_{D_Drive} = 13\text{ A}$, DC = 20%, PW = 150 us, $P_{IN} = 32\text{ dBm}$, $P_{OUT,SAT} = 50.3\text{ dBm}$	0.25	°C/W
Channel Temperature, T_{CH} ⁽²⁾	$P_{DISS} = 206\text{ W}$	137	°C
Thermal Resistance, θ_{JC} ⁽¹⁾	CW , $T_{base} = 85\text{ °C}$, $V_D = 24\text{ V}$, $I_{DQ} = 3.4\text{ A}$, Freq = 7 GHz, $I_{D_Drive} = 9\text{ A}$, $P_{IN} = 28\text{ dBm}$, $P_{OUT} = 46\text{ dBm}$	0.43	°C/W
Channel Temperature, T_{CH} ⁽²⁾	$P_{DISS} = 177\text{ W}$	161	°C

Notes:

1. Thermal resistance determined to the back of package (85 °C)
2. Channel temperature indicated is an IR scan equivalent temperature. Thermal resistance is calculated using this value. Additional information can be found in the Qorvo Applications Note “GaN Device TCHMAX Theta-JC and Reliability Estimates,” located here <https://www.qorvo.com/products/d/da006480>

Dissipated Power and Maximum Gate Current

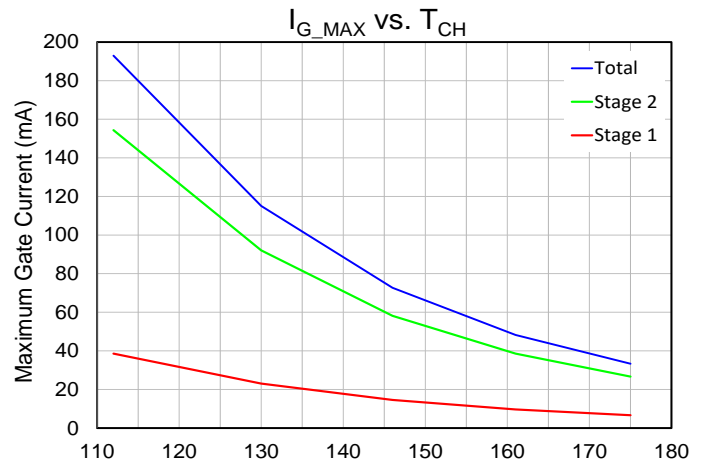
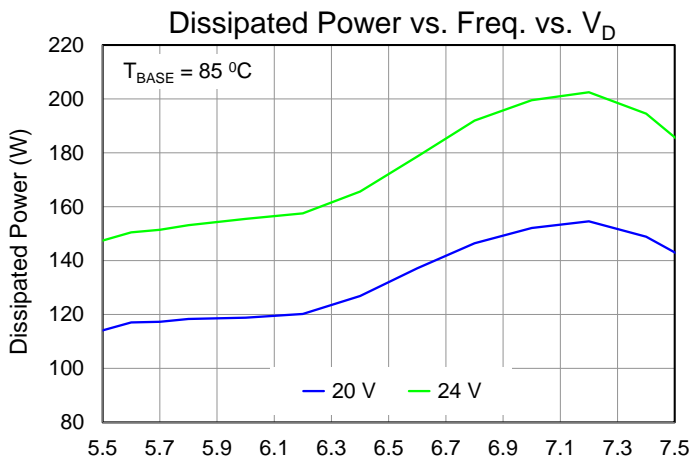

Test conditions, unless otherwise noted: Pulsed, $V_D = 24\text{ V}$, $I_{DQ} = 3.4\text{ A}$, $P_{IN} = +32\text{ dBm}$, $T_{BASE} = +85\text{ °C}$

Applications Information

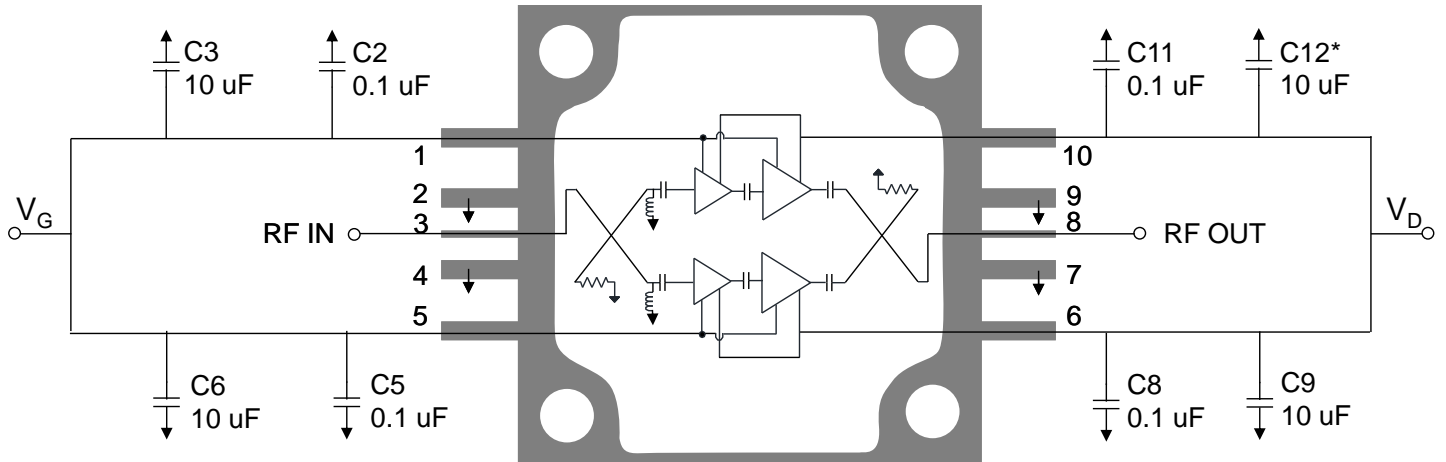

*C9, *C12: optional, to optimize linearity depending tone spacing, not populated on Qorvo's EVB, see performances on page 9 – 14

Bias-Up Procedure

1. Set I_D limit to 200 mA, I_G limit to 18 A
2. Set V_G to -5.0 V
3. Set V_D +24 V
4. Adjust V_G more positive until $I_{DQ} = 3.4$ A ($V_G \approx -2.5V \pm$ typical)
5. Apply RF signal

Bias-Down Procedure

1. Reduce V_G to -5.0 V. Ensure $I_{DQ} \sim 0$ mA
2. Set V_D to 0 V
4. Turn off RF signal
5. Turn off V_D supply
6. Turn off V_G supply

Evaluation Board (EVB) Layout Assembly

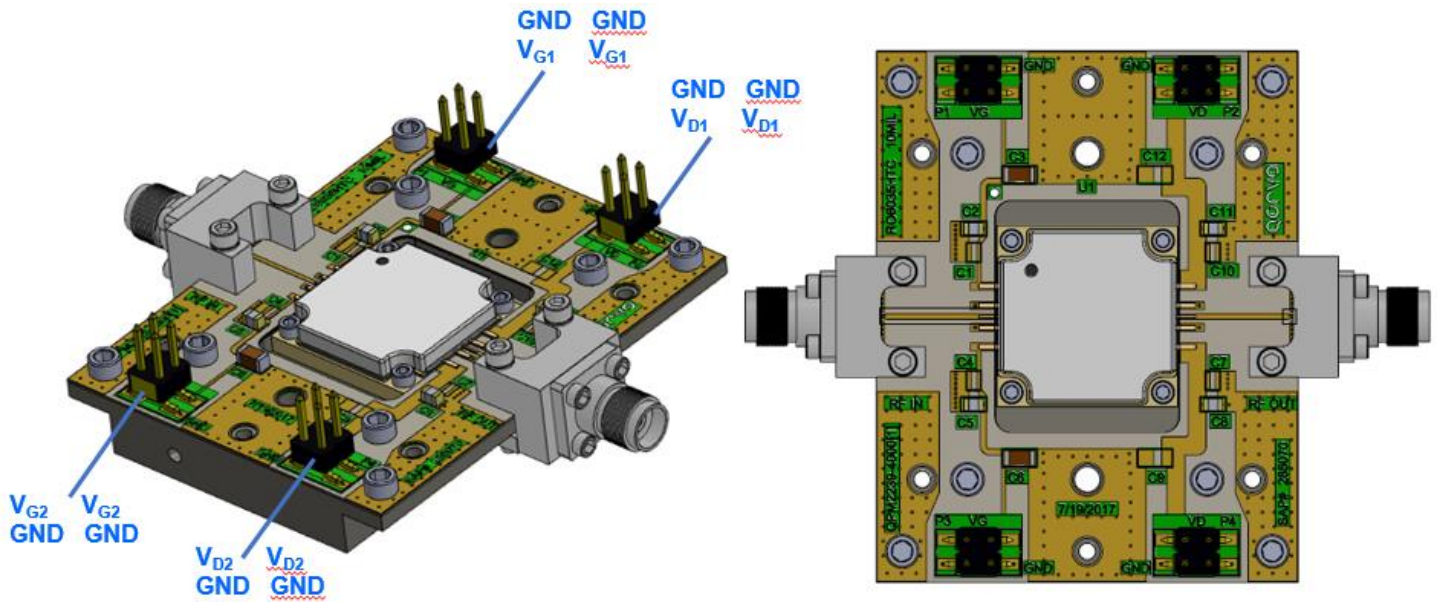

Bill of Materials

Reference Des.	Value	Description	Manuf.	Part Number
U1	-	100W C-Band GaN Power Amplifier Module	Qorvo	QPM1017
C2, C5, C8, C11	0.1 uF	CAP, 0.1uF, ±10%, 50V, X7R, 0805	Various	
C3, C6	10 uF	CAP, 10uF, 20%, 50V, 20%, X5R, 1206	Various	
C9, C12	10 uF	CAP, 10uF, 20%, 50V, 20%, X5R, 1206 Optional, to optimize linearity depending tone spacing, see page 19 for recommendation, not populated on Qorvo EVB.	Various	
H1, H2, H3, H4	-	CONN, HDR, 4 POS, 2 RAW, SMD, Au	Various	
J1, J2	-	Connector, Female, End Launch, 1092-02A-5	Southwest Microwave	1092-02A-5
S1 – S8	-	Screw, Cap, Socket Head, 2-56X1/8"	Various	
S9 – S12	-	Screw, Cap, Socket Head, 0-80X3/32"	Various	
PCB	-	PCB, Rogers 6035 10mils, 1oz Ni/Au plating 2 sides	Various	Custom
H-Block	-	H-Block, Copper C110, 1.744x 2.201 x 0.275T	Various	Custom
Solder	-	Paste, solder, Syntech, Sn62/Pb36/Ag2	Inventec Performance Chemicals USA	Syntech, SN62, T3, 90.5, 250J
Epoxy	-	Epoxy, Ablebond 84-1LMI 3cc	Henkel Corporation	84-1LMI
Thermal Compound	-	CHEM, Thermal Compound, Silver 5GR	Artic Silver	Artic Silver 5 AS5-3.5G

Mechanical Information

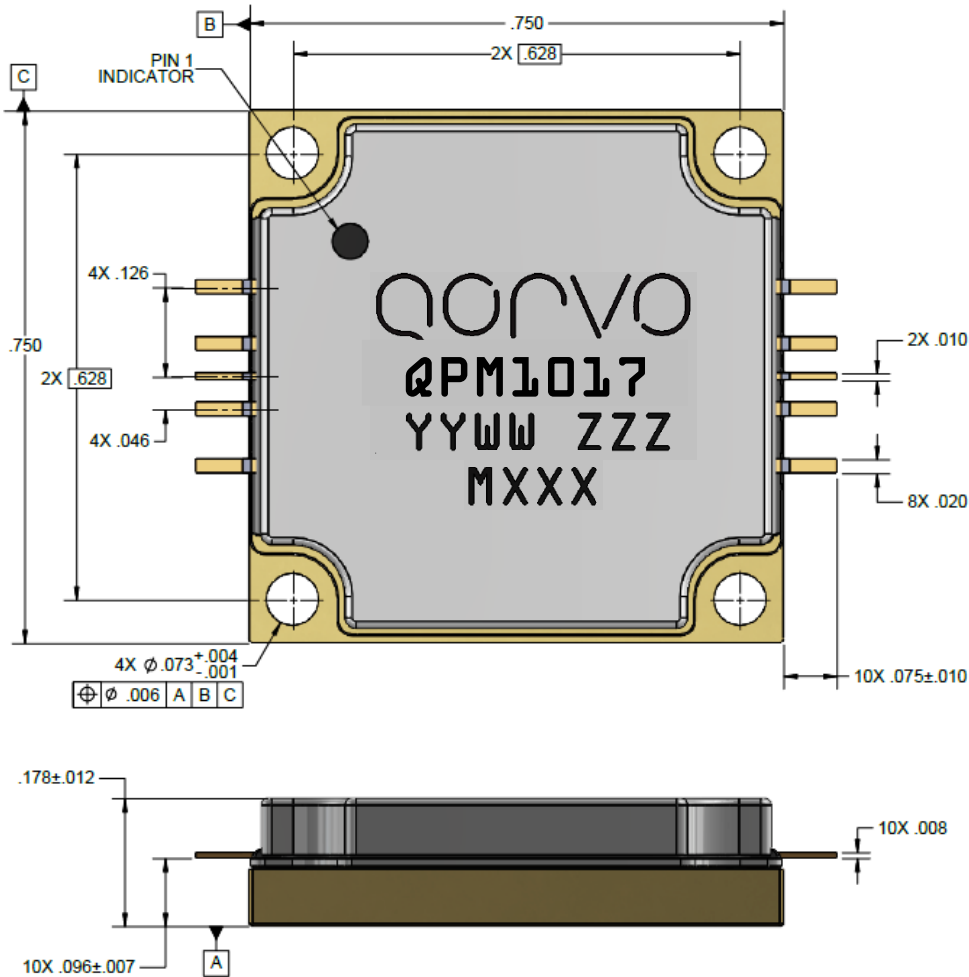

NOTES:

1. MATERIALS
 PACKAGE BASE: COPPER
 LEADS: ALLOY 194
 LID: PLASTIC
 FINISH: GOLD
2. PART IS EPOXY SEALED
3. UNITS: INCHES
4. TOLERANCES (UNLESS NOTED):
 .XX = $\pm .01$
 .XXX = $\pm .005$
5. MARKINGS
 PART NUMBER: QPM1017
 WORK YEAR: YY
 WORK WEEK: WW
 SERIAL NUMBER: ZZZ
 BATCH ID: MXXX

Pin Description

Pin No.	Symbol	Description
1	V _{G1}	Gate voltage Amp 1. External bypassing required; refer to page 19 for recommendation
2, 4, 7, 9	Ground	Must be grounded to PCB
3	RF _{IN}	RF Input. Matched to 50 Ω, DC blocked, DC shorted to ground
5	V _{G2}	Gate voltage Amp 2. External bypassing required; refer to page 19 for recommendation
6	V _{D2}	Drain voltage Amp 2. External bypassing required; refer to page 19 for recommendation
8	RF _{OUT}	RF Output. Matched to 50 Ω, DC blocked
10	V _{D1}	Drain voltage Amp 1. External bypassing required; refer to page 19 for recommendation

Assembly Notes

1. Carefully clean the PC board and package leads with alcohol. Allow it to dry fully.
2. To improve the thermal and RF performance, Qorvo recommends attaching a heat sink to the bottom of the PCB and apply thermal compound (Arctic Silver 5 recommended) or 4 mil indium shim between the heat sink and the package.
3. (The following is for *information only*. There are many variables in a second level assembly that Qorvo does not control, so Qorvo does not recommend an absolute torque value.) Use screws to attach the component to the heat sink. A suggested torque value is 16 in-oz. for a 0-80 screw. Start with screws finger tight, then torque to 8 in-oz., then torque to final value. Use the following tightening pattern:

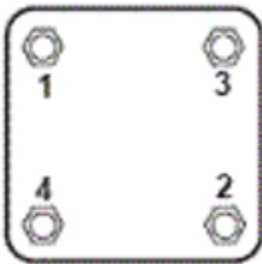

4. The component leads should be manually soldered. Apply a low residue solder alloy meeting J-STD-001 (ROL0, ROL1 or equivalent) with a liquidus temperature below 220 °C to each pin of the QPM1017. The use of low residue/no-clean flux (ROL0, ROL1) is recommended. Adding flux during hand soldering of the component leads with localized spot cleaning is acceptable. Soldering irons meeting the requirements of J-STD-001, Appendix A are acceptable. The packaged part should not be subjected to conventional SMT automated solder reflow processes.

Solderability

The component leads should be manually soldered, and the package cannot be subjected to conventional reflow processes. The use of no-clean solder to avoid washing after soldering is recommended.

Handling Precautions

Parameter	Rating	Standard
ESD – Human Body Model (HBM)	1A	ANSI/ESD/JEDEC JS-001
ESD – Charged Device Model (CDM)	C2a	ANSI/ESD/JEDEC JS-002
MSL – Moisture Sensitivity Level	N/A	Blank, null, no content



Caution!

ESD-Sensitive Device

RoHS Compliance

This part is compliant with 2011/65/EU RoHS directive (Restrictions on the Use of Certain Hazardous Substances in Electrical and Electronic Equipment) as amended by Directive 2015/863/EU.

This product also has the following attributes:

- Product uses RoHS Exemption 7c-I to meet RoHS Compliance requirements
- Halogen Free (Chlorine, Bromine)
- Antimony Free
- TBBP-A (C₁₅H₁₂Br₄O₂) Free
- PFOS Free
- SVHC Free

Contact Information

For the latest specifications, additional product information, worldwide sales and distribution locations:

Web: www.qorvo.com

Tel: 1-844-890-8163

Email: customer.support@qorvo.com

Important Notice

The information contained herein is believed to be reliable; however, Qorvo makes no warranties regarding the information contained herein and assumes no responsibility or liability whatsoever for the use of the information contained herein. All information contained herein is subject to change without notice. Customers should obtain and verify the latest relevant information before placing orders for Qorvo products. The information contained herein or any use of such information does not grant, explicitly or implicitly, to any party any patent rights, licenses, or any other intellectual property rights, whether with regard to such information itself or anything described by such information. **THIS INFORMATION DOES NOT CONSTITUTE A WARRANTY WITH RESPECT TO THE PRODUCTS DESCRIBED HEREIN, AND QORVO HEREBY DISCLAIMS ANY AND ALL WARRANTIES WITH RESPECT TO SUCH PRODUCTS WHETHER EXPRESS OR IMPLIED BY LAW, COURSE OF DEALING, COURSE OF PERFORMANCE, USAGE OF TRADE OR OTHERWISE, INCLUDING THE IMPLIED WARRANTIES OF MERCHANTABILITY AND FITNESS FOR A PARTICULAR PURPOSE.**

Without limiting the generality of the foregoing, Qorvo products are not warranted or authorized for use as critical components in medical, life-saving, or life-sustaining applications, or other applications where a failure would reasonably be expected to cause severe personal injury or death.

Copyright 2022 © Qorvo, Inc. | Qorvo is a registered trademark of Qorvo, Inc.