

Product Description

The QPF4006 is a multi-function Gallium Nitride MMIC front-end module targeted for 39 GHz phased array 5G base stations and terminals. The device combines a low noise high linearity LNA, a low insertion-loss high-isolation TR switch, and a high-gain high-efficiency multi-stage PA.

The QPF4006 operates from 37 GHz to 40.5 GHz range. The receive path (LNA+TR SW) is designed to provide 18dB of gain and a noise figure less than 4.5 dB. The transmit path (PA+SW) provides 23 dB of small signal gain and a saturated output power of 2 W.

The compact 4.5 mm x 4.0 mm surface mount package configuration is designed to meet the tight lattice spacing requirements for phased array applications.

The QPF4006 is fabricated on Qorvo's 0.15um GaN on SiC process. It is housed in an air-cavity laminate package with an embedded copper heat slug. The copper slug, coupled with a low thermal resistance die-attach process, allows the QPF4006 to operate at the extreme case temperatures needed in phased array applications.

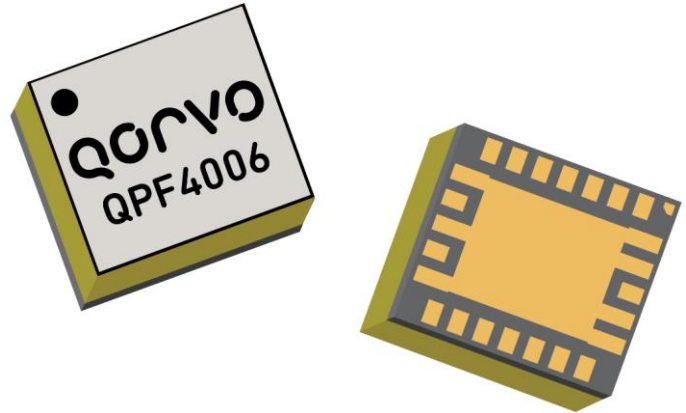

Product Features

- Frequency Range: 37 – 40.5 GHz
- RX Noise Figure: 4.2 dB
- RX Small Signal Gain: 18 dB
- RX Saturated Power: 17 dBm
- RX TOI : 20 dBm @ - 5 dBm Pin / tone
- TX Small Signal Gain: 23 dB
- TX Saturated Power: 33 dBm
- TX TOI: 42 dBm @ 24 dBm Pout / tone
- TX ACPR: 32dBc @ 24dBm average Pout²
- TX Linearity: 4% EVM @ 24 dBm average Pout²
- TX PAE: 7% @ 24 dBm average Pout.
- Package Dimensions: 4.5 x 4.0 x 1.8 mm

1. Performance is typical at room temperature.
2. OFDM, 400 MHz modulation bandwidth, 64QAM.

Functional Block Diagram

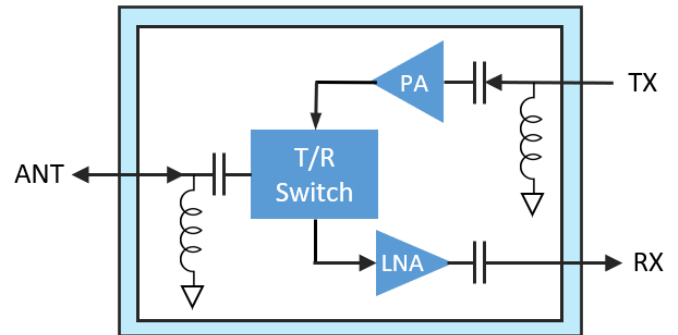

Applications

- 5G Wireless Base stations and terminals
- Point to Point Communications

Part No.	Description
QPF4006TR7	Tape and Reel, 7", Qty 250
QPF4006EVB03	QPF4006 Evaluation Board, Qty 1

Absolute Maximum Ratings

Parameter	Value
Drain Voltage (TXVD, RXVD)	28 V
Drain Current (TXID3+TXID12)	800 mA
Drain Current (RXID)	60 mA
Gate Voltage (RXVG, TXVG3, TXVG12)	0 to -5 V
Gate Current (RXIG, TXIG3, TXIG12)	20 mA
Switch Control Voltage (TXSW, RXSW)	0 to 28 V
Switch Control Current	20 mA
RF Input Power (All RF ports, 85 °C)	30 dBm
Channel Temperature, T _{CH}	225 °C
Mounting Temperature (30 seconds)	260 °C
Storage Temperature	-55 to 150 °C

Operation of this device outside the parameter ranges given above may cause permanent damage. These are stress ratings only, and functional operation of the device at these conditions is not implied. Extended application of Absolute Maximum Rating conditions to the device may reduce device reliability.

Normal Operating Conditions

Parameter	Value
Drain Voltage	20 V
Drain Current (TXIDQ12 / TXIDQ3)	135 mA / 24 mA *
Drain Current (RX, IDQ)	15 mA
Gate Voltage (TXVG12/TXVG3)	-2 V / -2.4 V
Gate Voltage (RXVG)	-2 V
Control Voltage (TXSW, RXSW)	TXSW = 0 V, RXSW = 20V (RX on, TX off) TXSW = 20 V, RXSW = 0V (RX off, TX on)
Operating Temperature Range	-40 to 95 °C

Gate voltage shown are typical, can be adjusted to set required drain current. Electrical specifications are measured at specified test conditions. Specifications are not guaranteed over all recommended operating conditions.

* Other current settings: 45 / 60 mA = 105 mA; 90 / 120 mA = 210 mA; 135 / 180 mA = 315 mA (gate controls combined together).

Electrical Specifications RX

Test conditions, unless otherwise noted: VD = 20 V, IDQ = 15 mA. Data de-embedded to device reference planes, 25 °C

Parameter	Min	Typical	Max	Units
Frequency	37		40.5	GHz
Small Signal Gain (37 – 39 GHz)	12	18		dB
Small Signal Gain (40 – 40.5 GHz)	13	18		dB
Noise Figure		4.2		dB
Saturated Output Power		17		dBm
Input Return Loss		12		dB
Output Return Loss		15		dB
Output TOI, @ -5 dBm Pin / tone, 10 MHz tone spacing		20		dBm
Gain Temperature Coefficient		-0.056		dB/°C

Electrical Specifications TX

Test conditions unless otherwise noted: VD = 20 V, TXIDQ12 / TXIDQ3 = 135mA / 24 mA
Data de-embedded to device reference planes, 25 °C

Parameter	Min	Typical	Max	Units
Frequency	37		40.5	GHz
Small Signal Gain (37 GHz)	14	23		dB
Small Signal Gain (38 - 39 GHz)	12	23		dB
Small Signal Gain (40 - 40.5 GHz)	10	23		dB
Saturated Output Power		33		dBm
Input Return Loss		12		dB
Output Return Loss		13		dB
Output TOI, @ 24dBm Pout / tone, 10 MHz tone spacing		42		dBm
ACPR (24 dBm average power, OFDM, 400MHz, 64QAM)		-32		dBc
EVM (24 dBm average power, OFDM, 400MHz, 64QAM)		4		%
PAE at average output power (24dBm)		7		%
Gain Temperature Coefficient		-0.112		dB/°C

Performance Plots, Small Signal, Receive Path

Test Conditions unless otherwise stated: RXVD = 20 V, RXIDQ = 15 mA, Data de-embedded to device reference planes, 25C

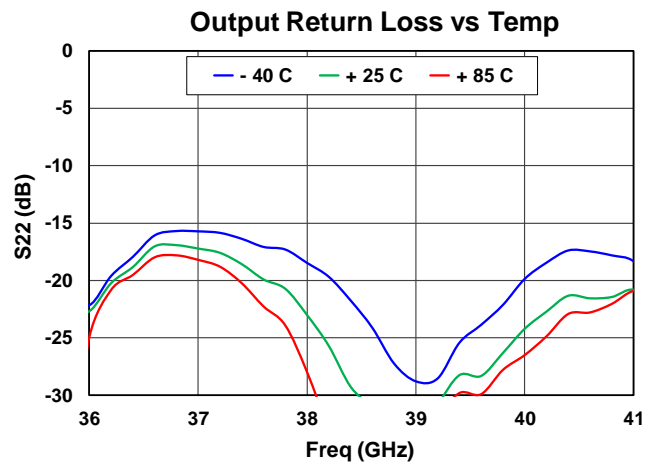
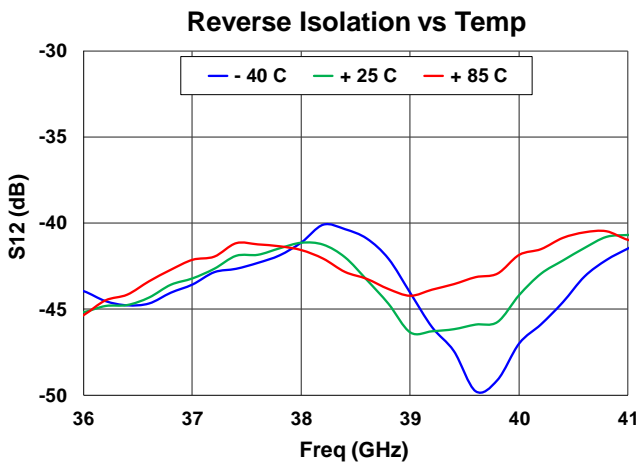
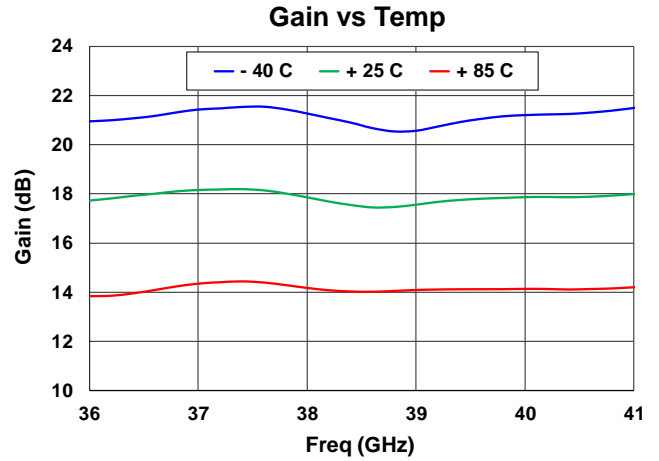
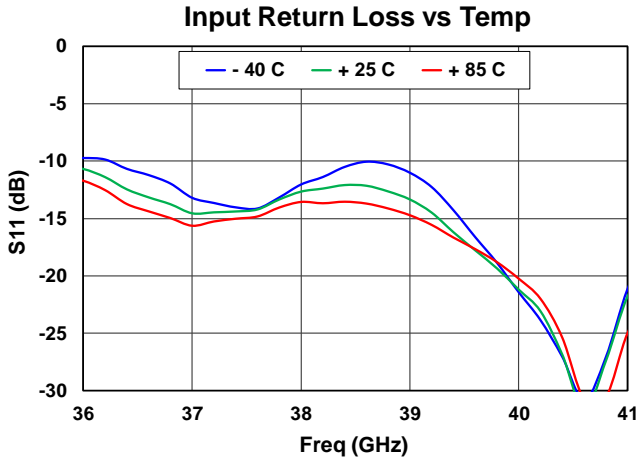

Performance Plots, Small Signal, Receive Path

Test Conditions unless otherwise stated: RXVD = 20 V, RXIDQ = 15 mA, Data de-embedded to device reference planes, 25 C

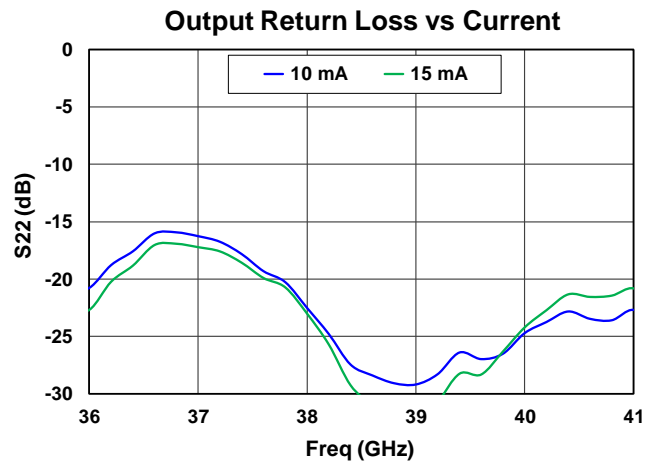
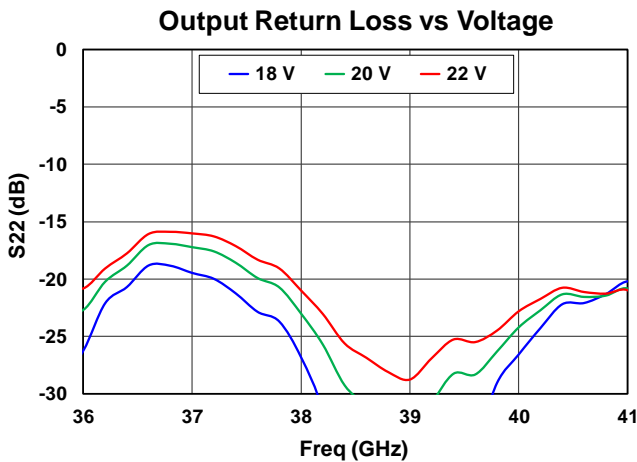
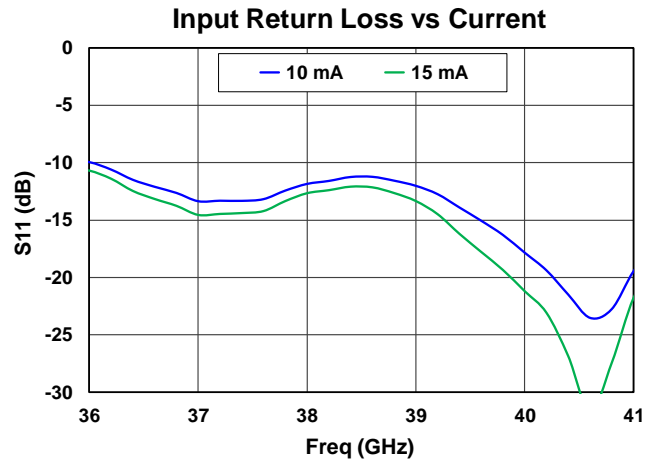
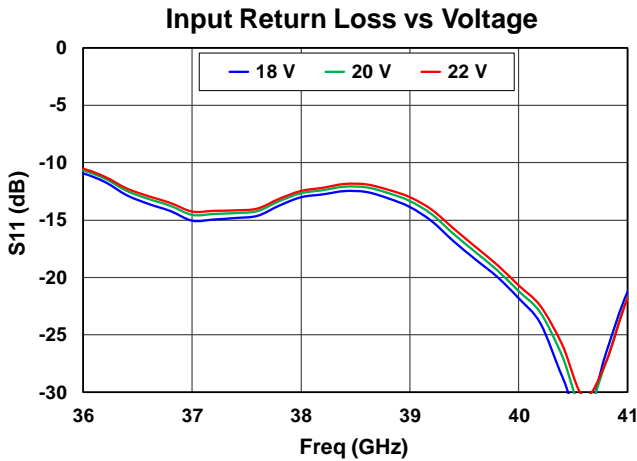
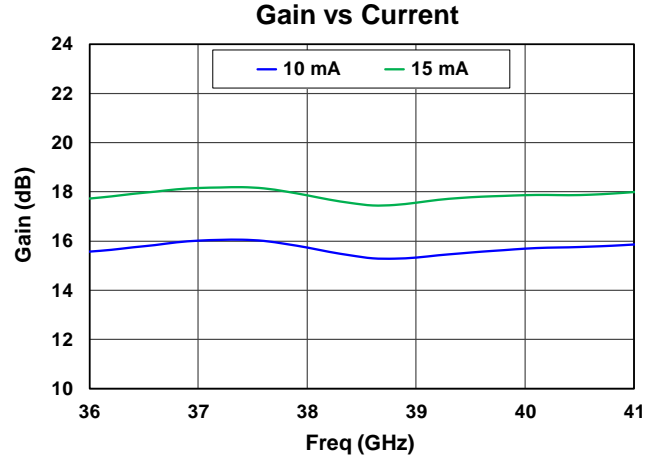
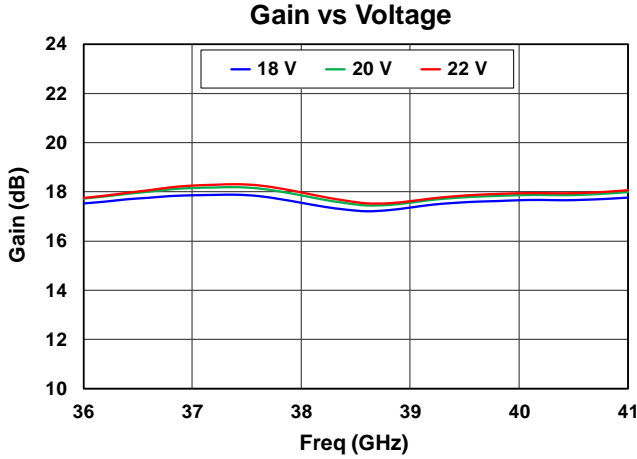

Performance Plots, Noise Figure, Receive Path

Test Conditions unless otherwise stated: RXVD = 20 V, RXIDQ = 15 mA, Data de-embedded to device reference planes, 25 C

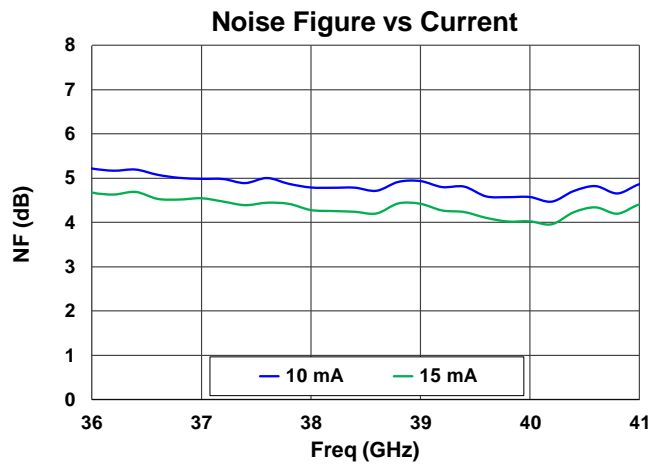
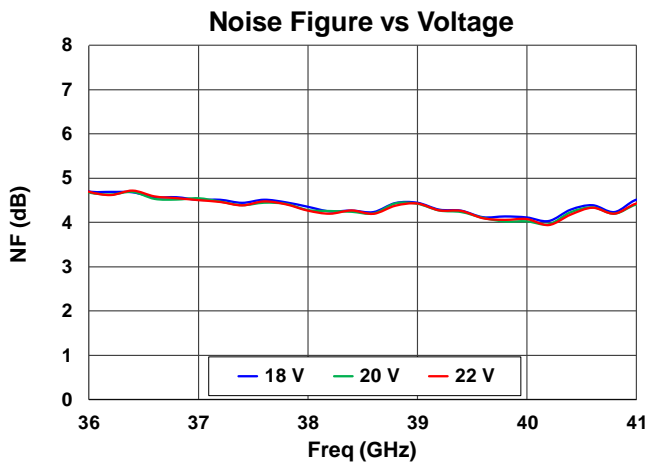
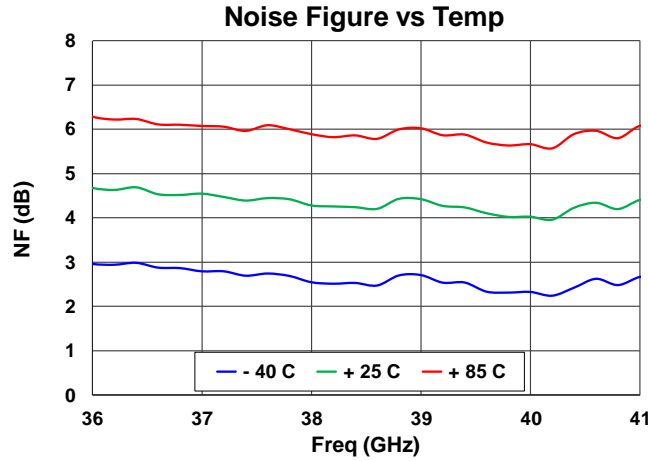

Performance Plots, Large Signal, Receive Path

Test Conditions unless otherwise stated: RXVD = 20 V, RXIDQ = 15 mA, CW. Data de-embedded to device reference planes, 25 C

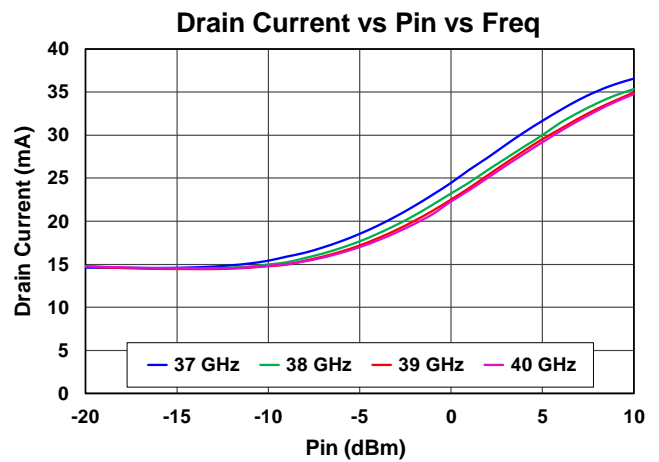
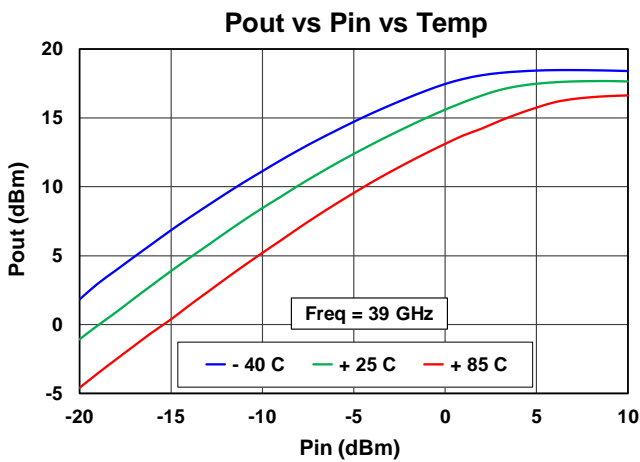
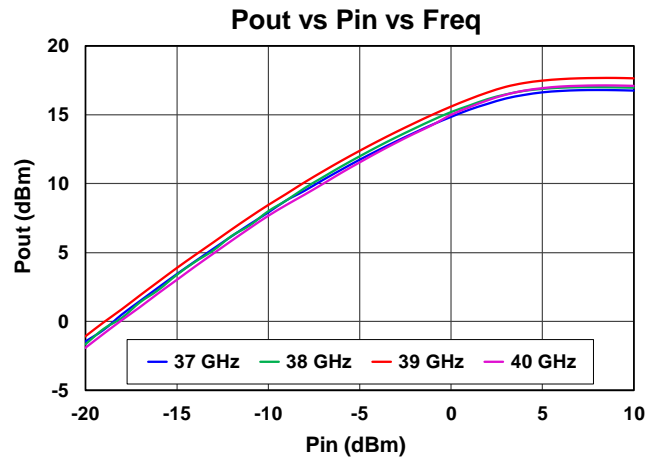
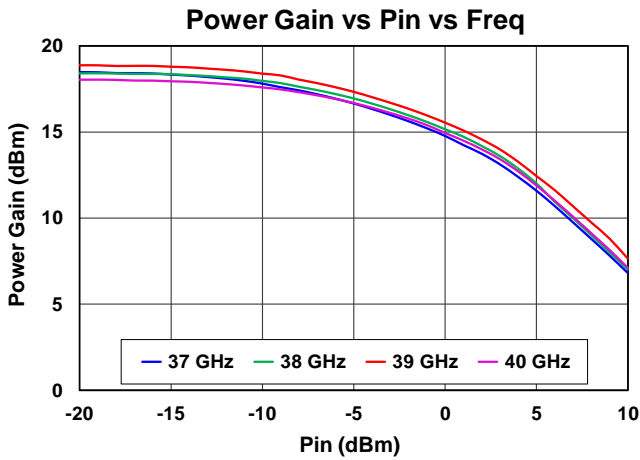
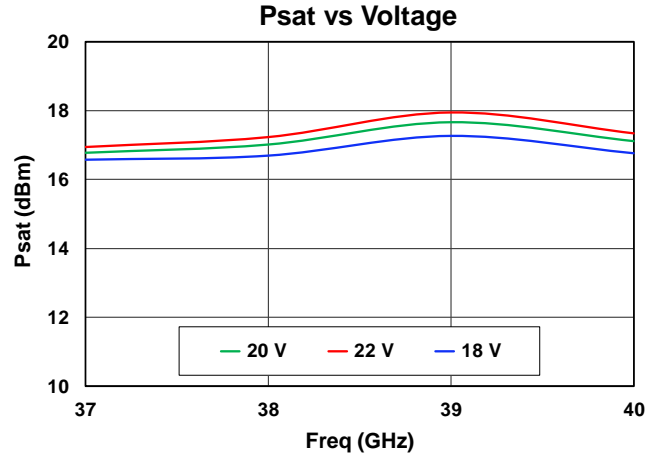
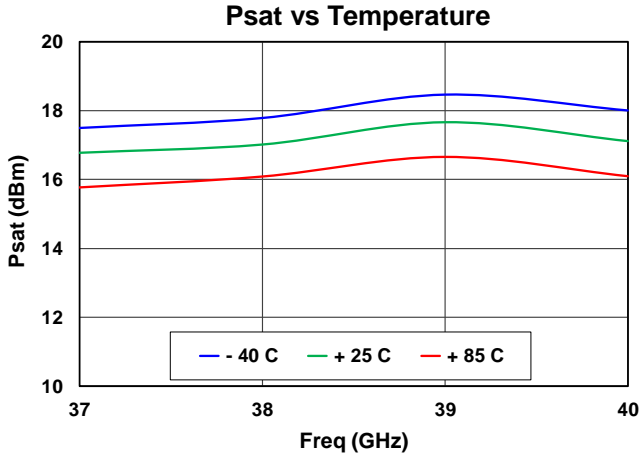

Performance Plots, Linearity, Receive Path

Test Conditions unless otherwise stated: RXVD = 20 V, RXIDQ = 15 mA, Tone spacing: 10 MHz
Data de-embedded to device reference planes, 25 C

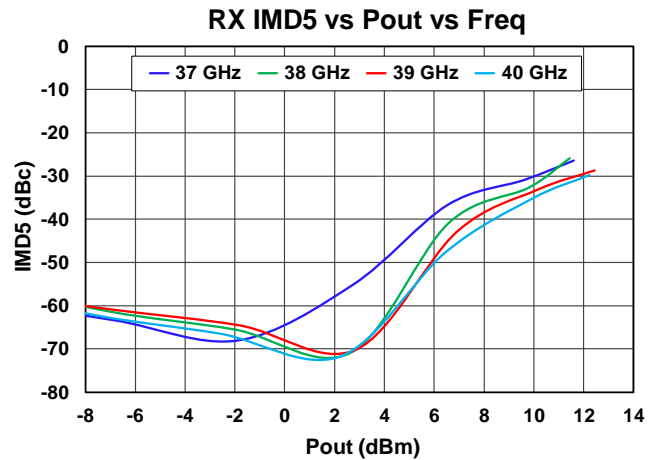
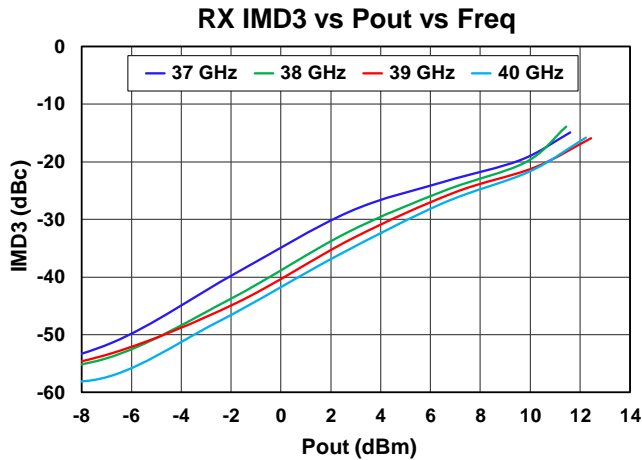
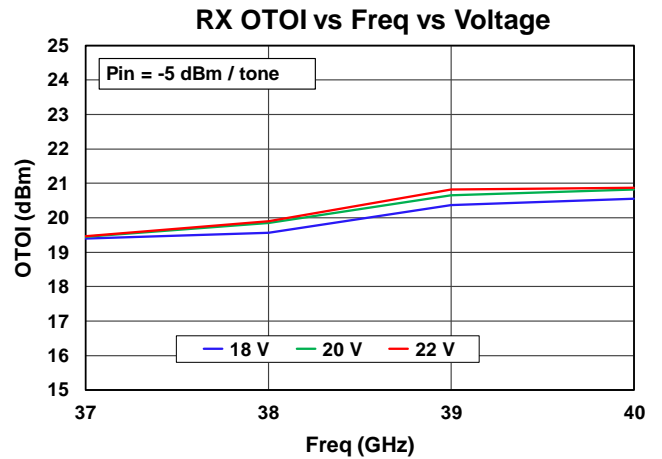
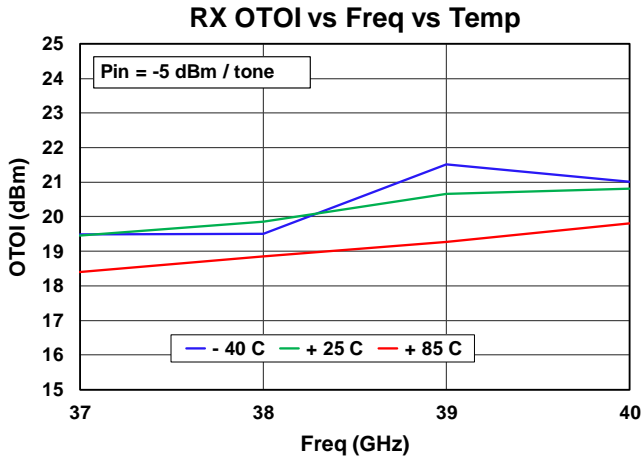

Performance Plots, Small Signal, Transmit Path

Test Conditions unless otherwise stated: TXVD = 20 V, TXIDQ12 = 135 mA, TXIDQ3 = 24 mA
 Data de-embedded to device reference planes

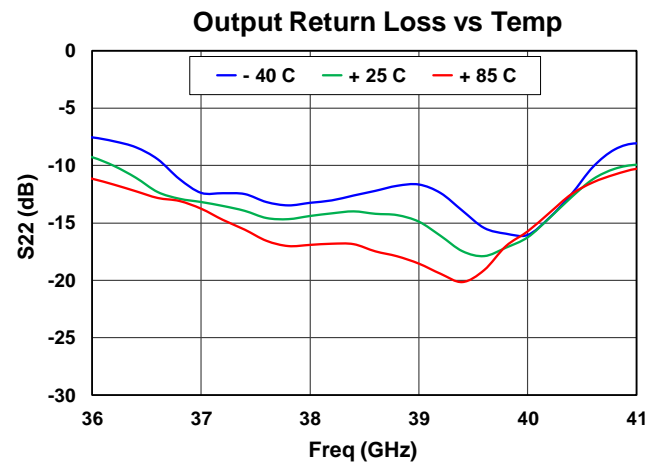
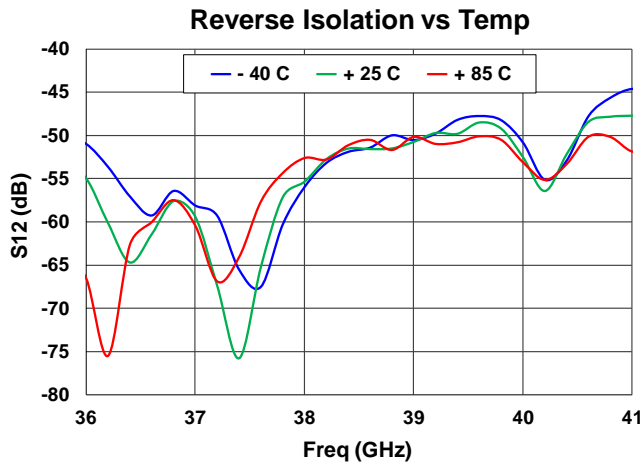
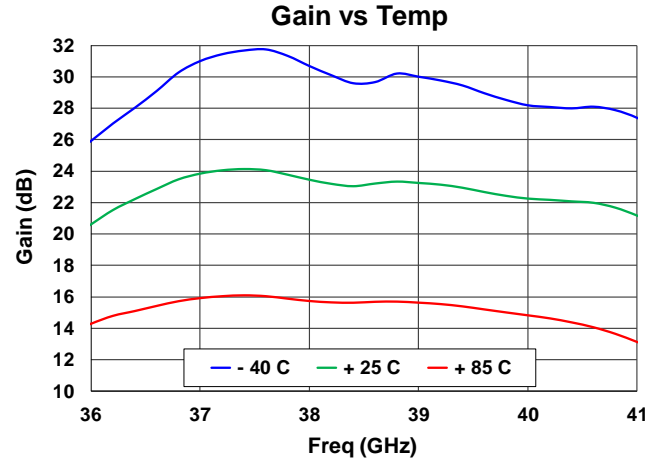
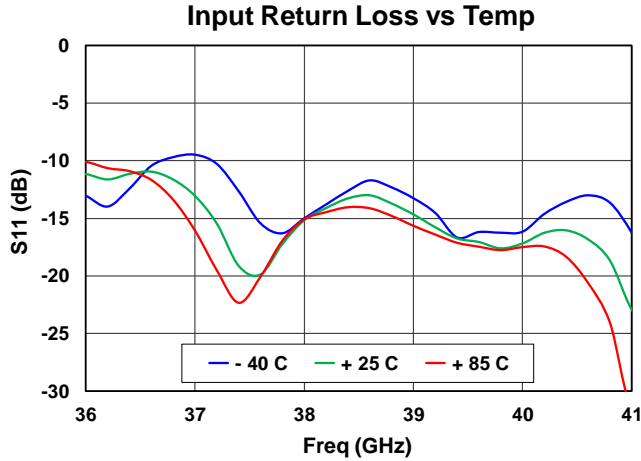

Performance Plots, Small Signal, Transmit Path

Test Conditions unless otherwise stated: TXVD = 20 V, TXIDQ12 = 135 mA, TXIDQ3 = 24 mA
 Data de-embedded to device reference planes, 25 C

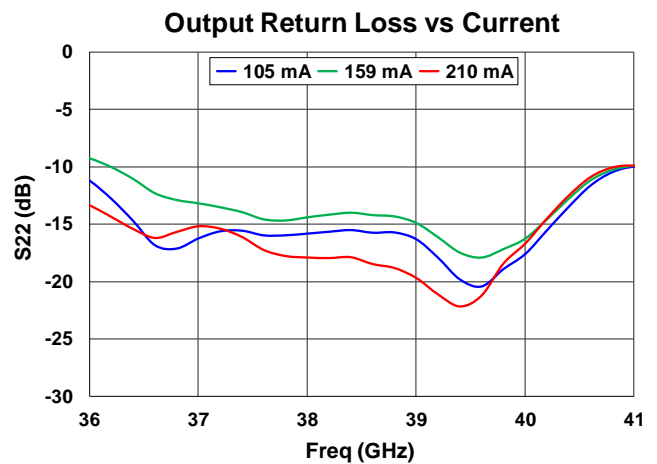
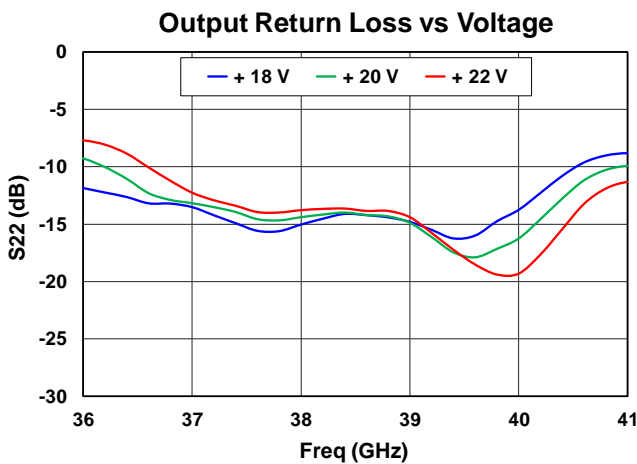
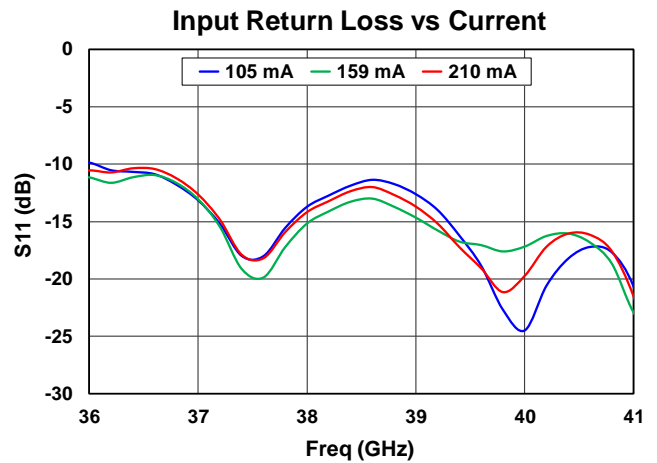
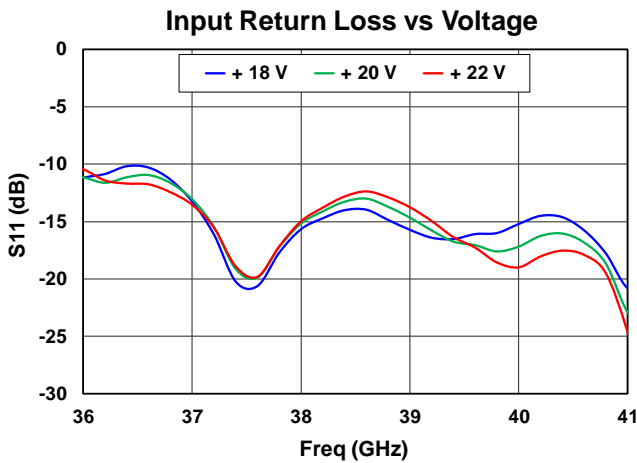
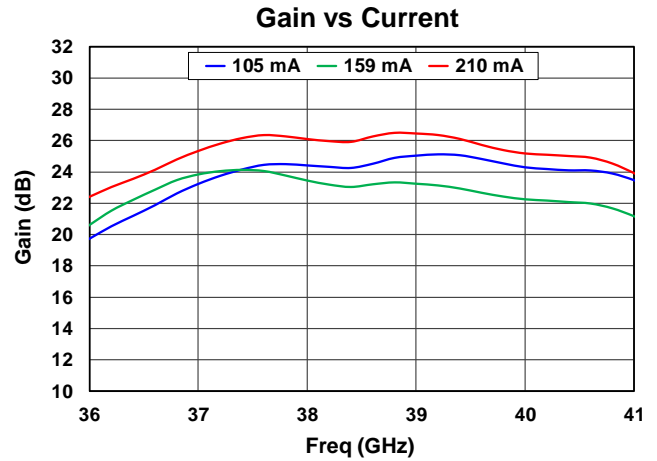
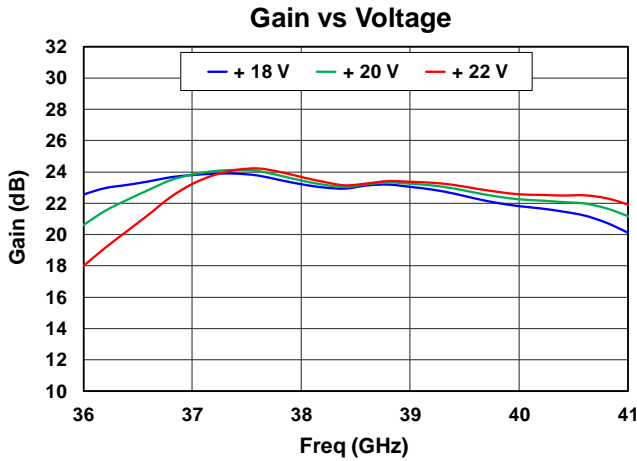

Performance Plots, Large Signal, Transmit Path

Test Conditions unless otherwise stated: TXVD = 20 V, TXIDQ12 = 135 mA, TXIDQ3 = 24 mA, Pulse Mode: PW = 100 uS, DC = 10%
 Data de-embedded to device reference planes, 25 C

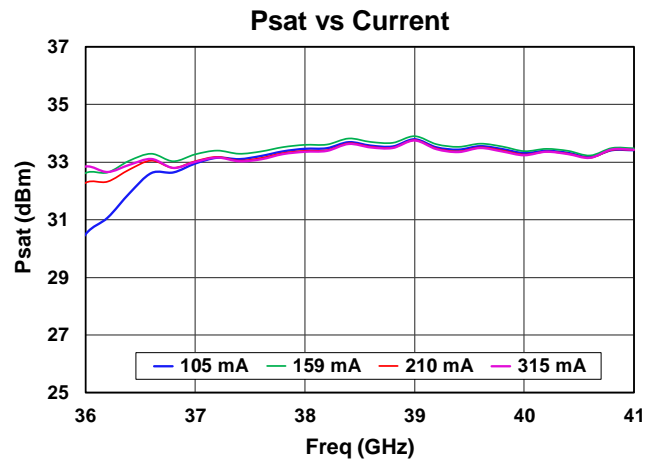
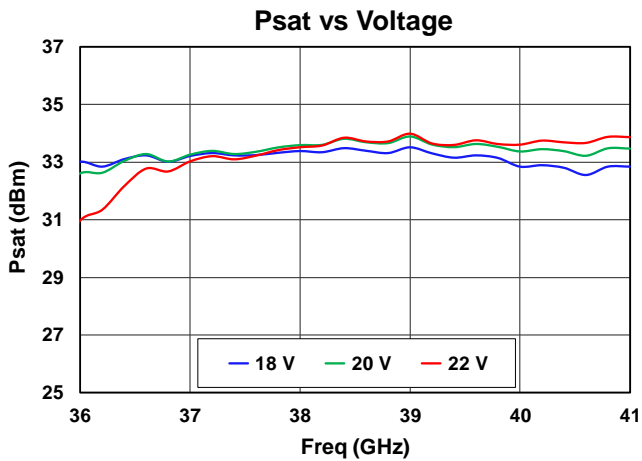
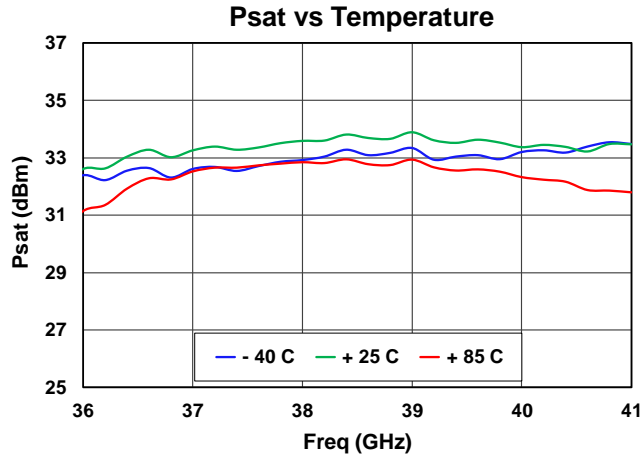

Performance Plots, Large Signal, Transmit Path

Test Conditions unless otherwise stated: TXVD = 20 V, TXIDQ12 = 135 mA, TXIDQ3 = 24 mA, Pulse Mode: PW = 100 uS, DC = 10%
 Data de-embedded to device reference planes. 25C

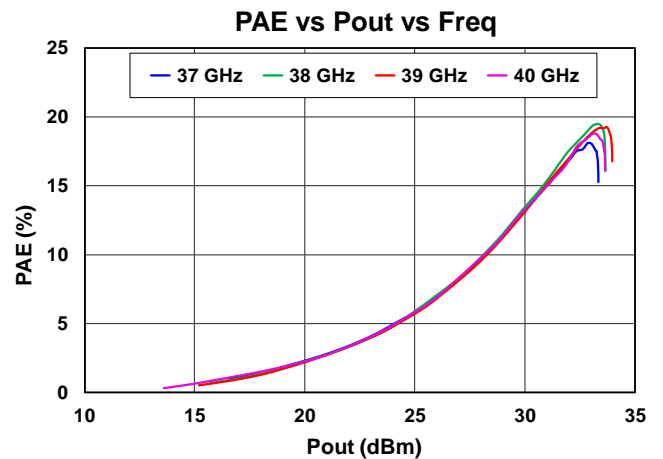
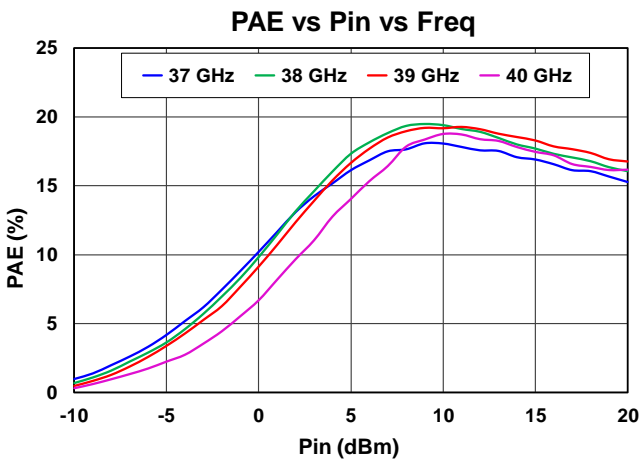
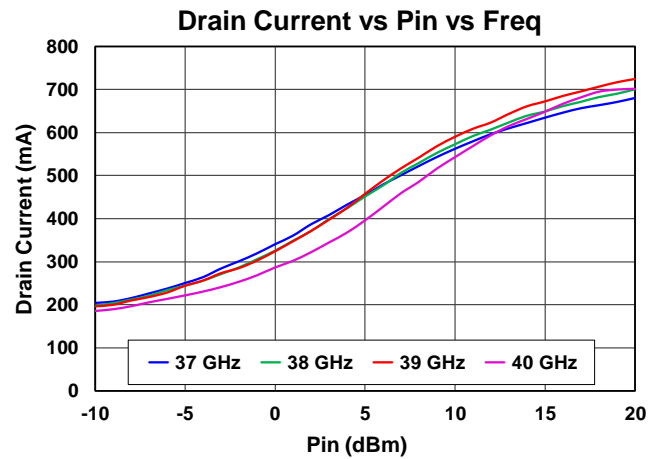
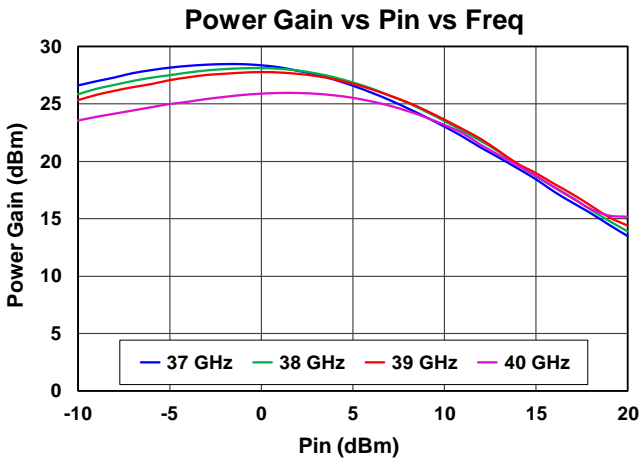
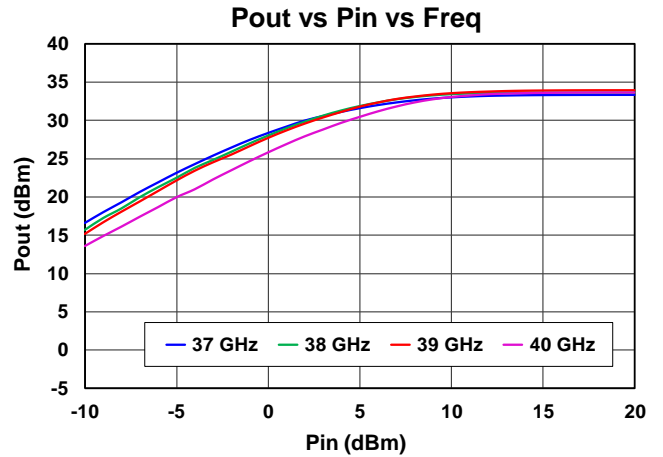
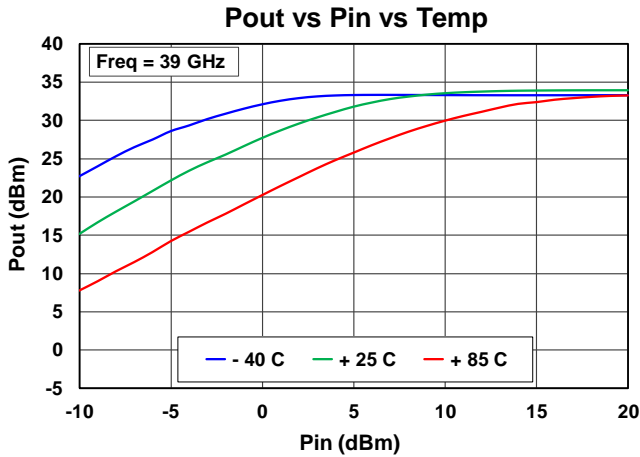

Performance Plots, Linearity, Transmit Path

Test Conditions unless otherwise stated: TXVD = 20 V, TXIDQ12 = 135 mA, TXIDQ3 = 24 mA, Tone Spacing = 10 MHz
 Data de-embedded to device reference planes, 25 C

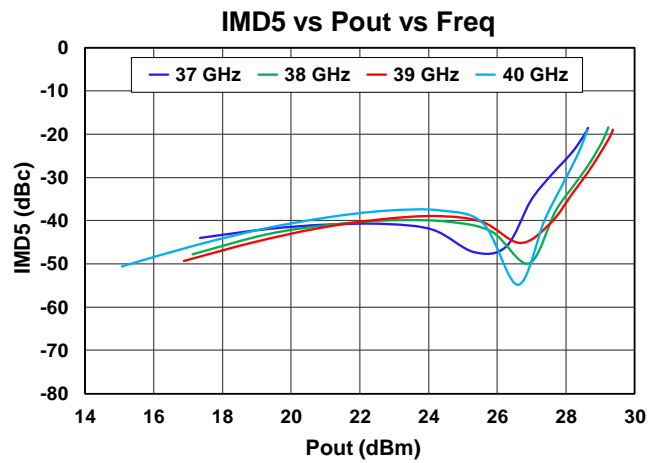
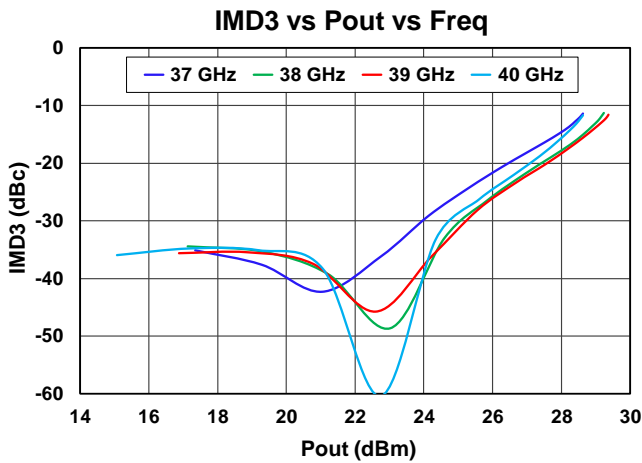
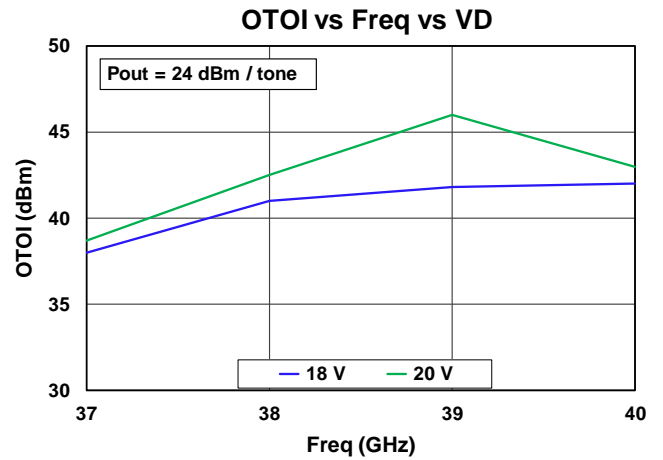
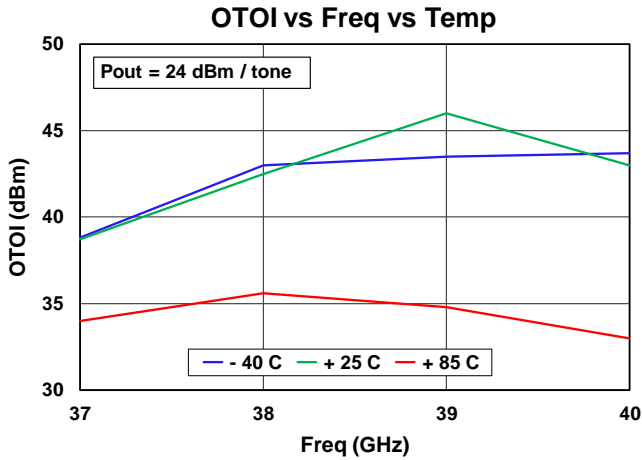

Performance Plots, Modulated Signal, Transmit Path

Test Conditions unless otherwise stated: TXVD = 20 V, TXIDQ12 = 135 mA, TXIDQ3 = 24 mA, Source: 400 MHz OFDM, 64 QAM
Data de-embedded to device reference planes, 25 C

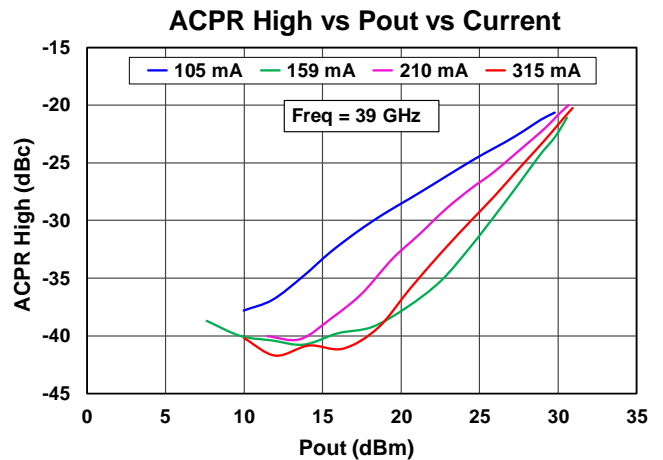
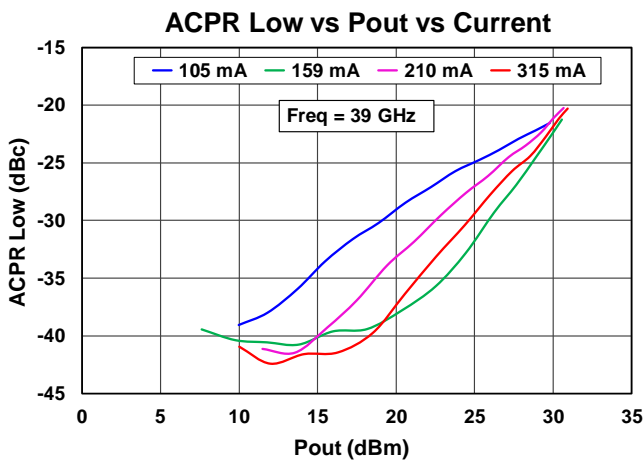
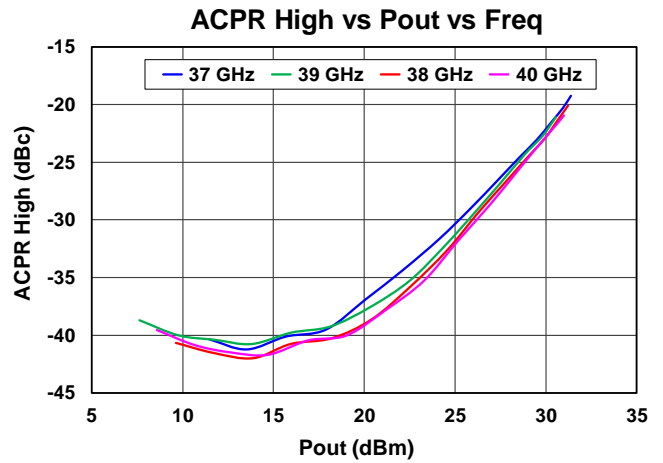
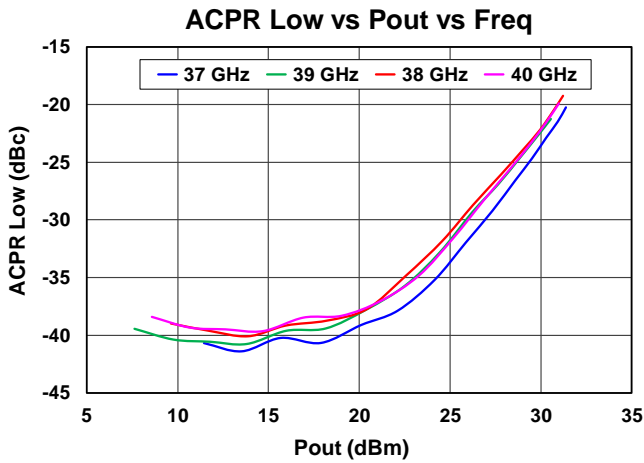
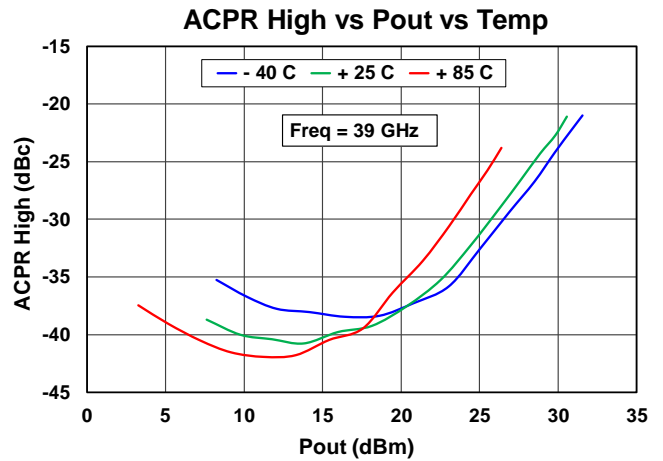
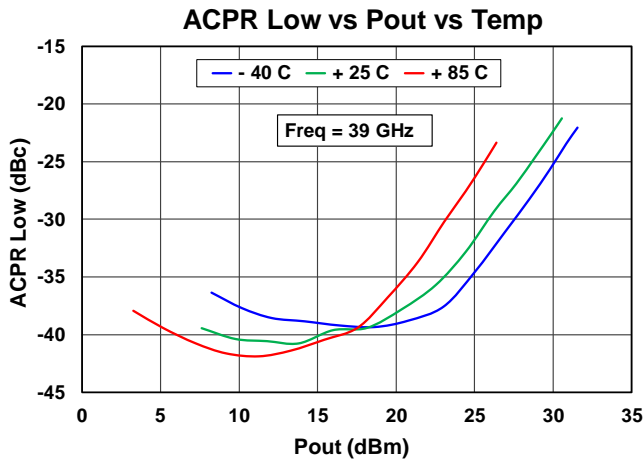

Performance Plots, Modulated Signal, Transmit Path

Test Conditions unless otherwise stated: TXVD = 20 V, TXIDQ12 = 135 mA, TXIDQ3 = 24 mA, Source: 400 MHz OFDM, 64 QAM Data de-embedded to device reference planes, 25 C

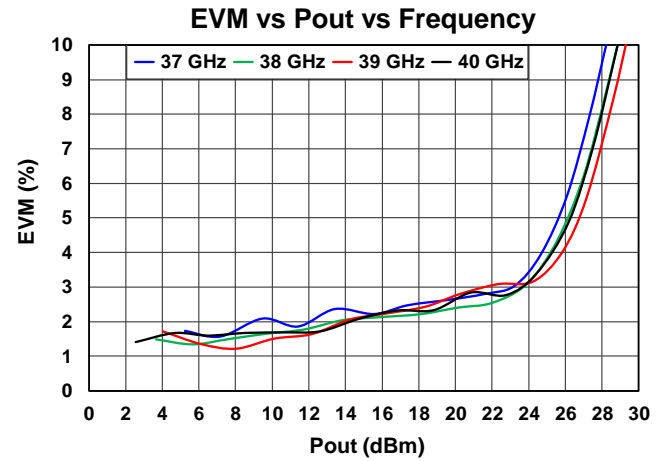
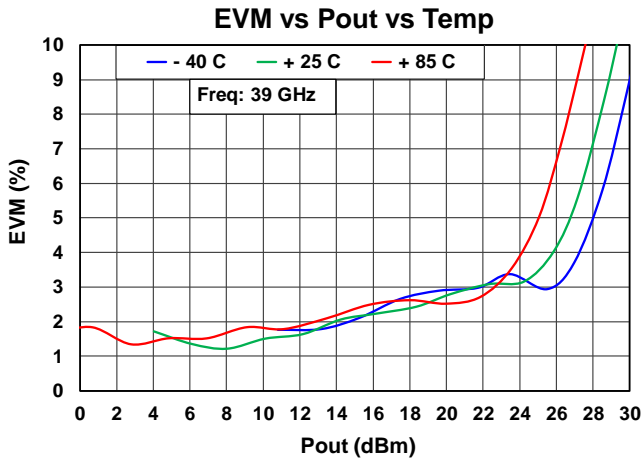
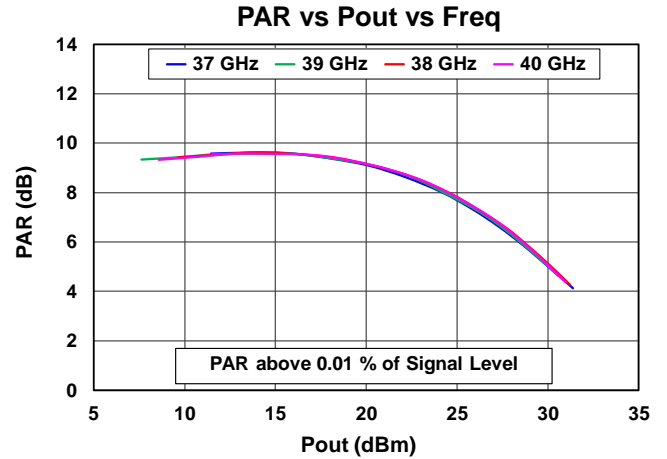
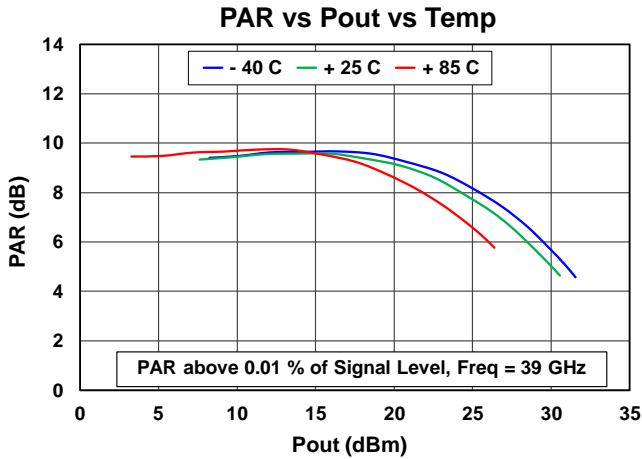

Performance Plots, Modulated Signal, Transmit Path

Test Conditions unless otherwise stated: TXVD = 20 V, TXIDQ12 = 135 mA, TXIDQ3 = 24 mA, Source: 400 MHz OFDM, 64 QAM
Data de-embedded to device reference planes, 25 C

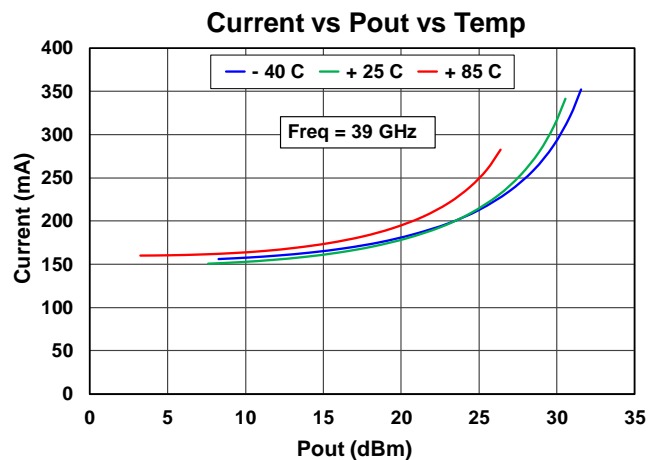
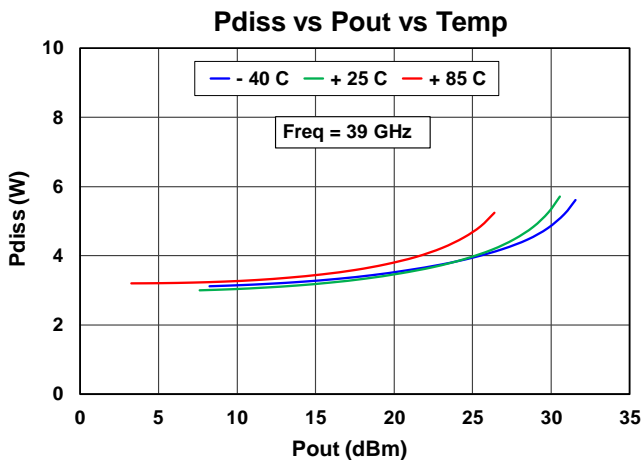
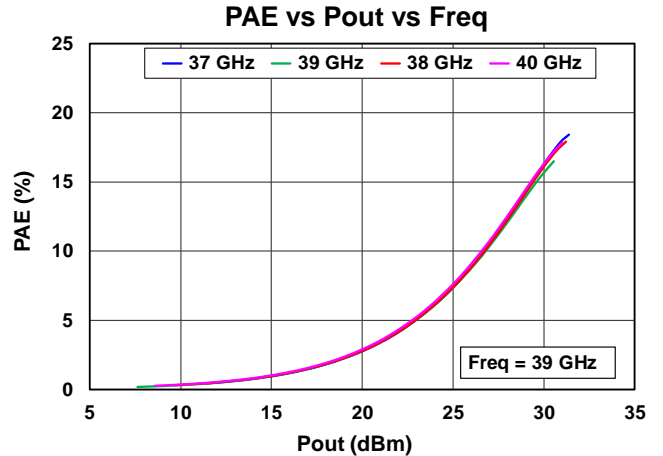
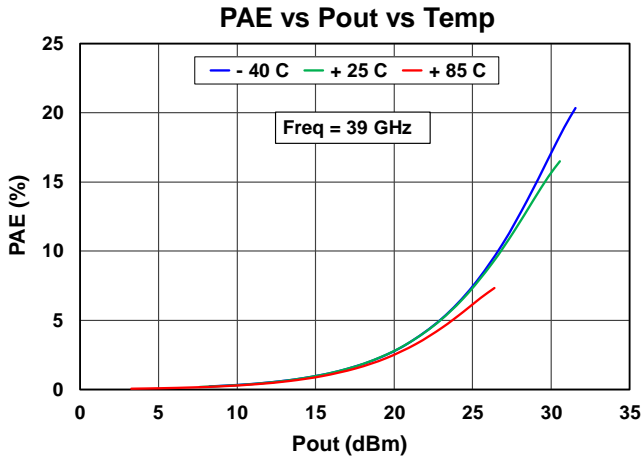
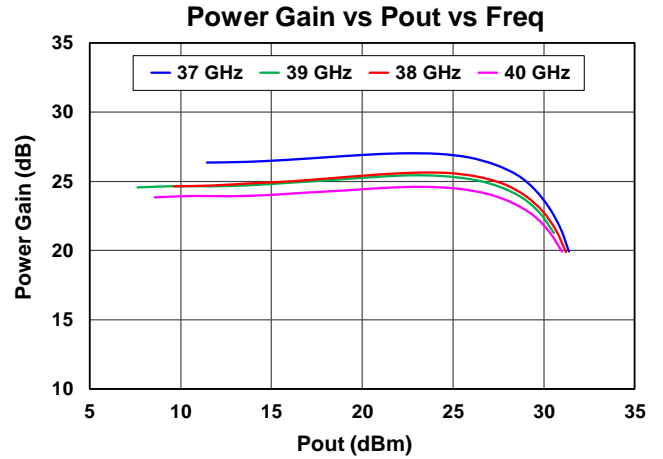
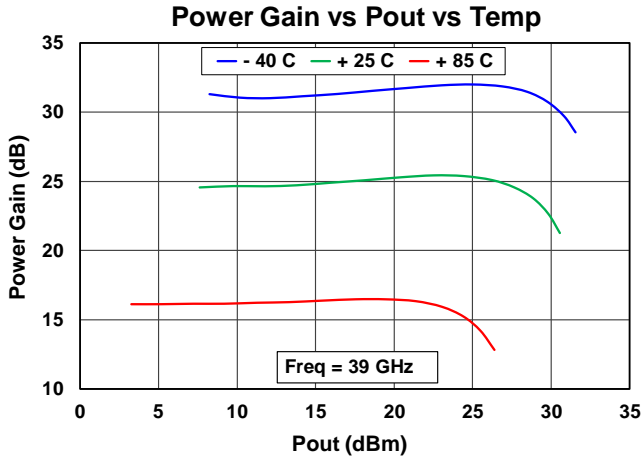

Mechanical Drawings & Pad Descriptions

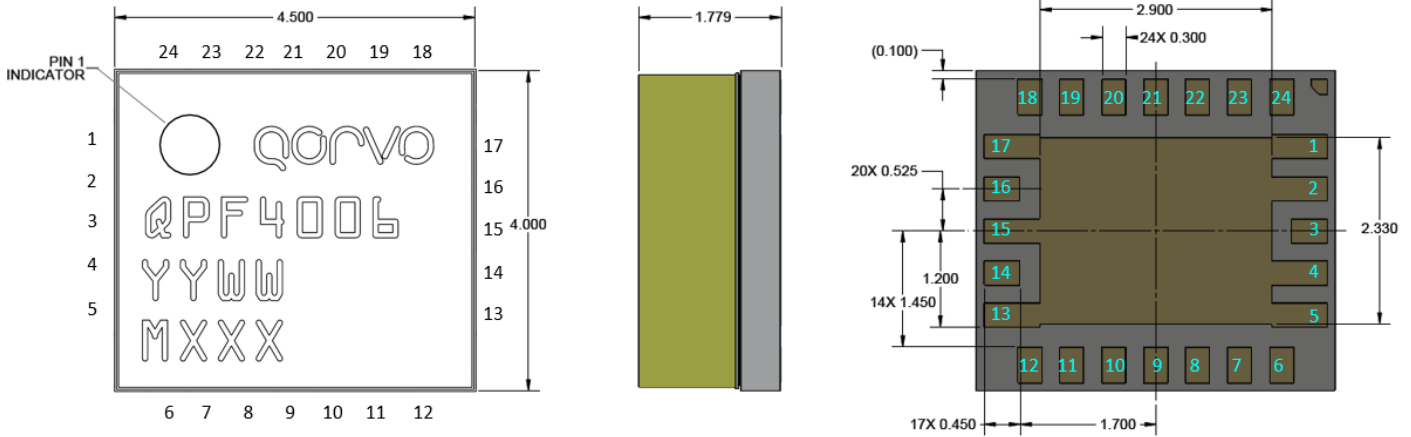

Dimensions in mm
 Part Marking:
 QPF4006: Part Number
 YY = Part Assembly Year
 WW = Part Assembly Week
 MXXX = Batch ID

Pin Number	Label	Description
1, 2, 4, 5, 13, 15, 17, slug	GND	GROUND
3	ANT	Antenna, DC Grounded
14	RXOUT	Receive output, DC Blocked
16	TXIN	Transmit input, DC Grounded
18	RXVG	Receive gate control
19	RXVD	Receive Drain Voltage
20	TXVG12	Transmit stage 1 and 2 gate controls
21	TXVG3	Transmit stage 3 gate control
22	TXVD	Transmit Drain Voltage
23	TXSW	Transmit switch control
24	RXSW	Receive switch control
6, 7, 8, 9, 10, 11, 12	N/C	No internal connection

Evaluation Board and Assembly

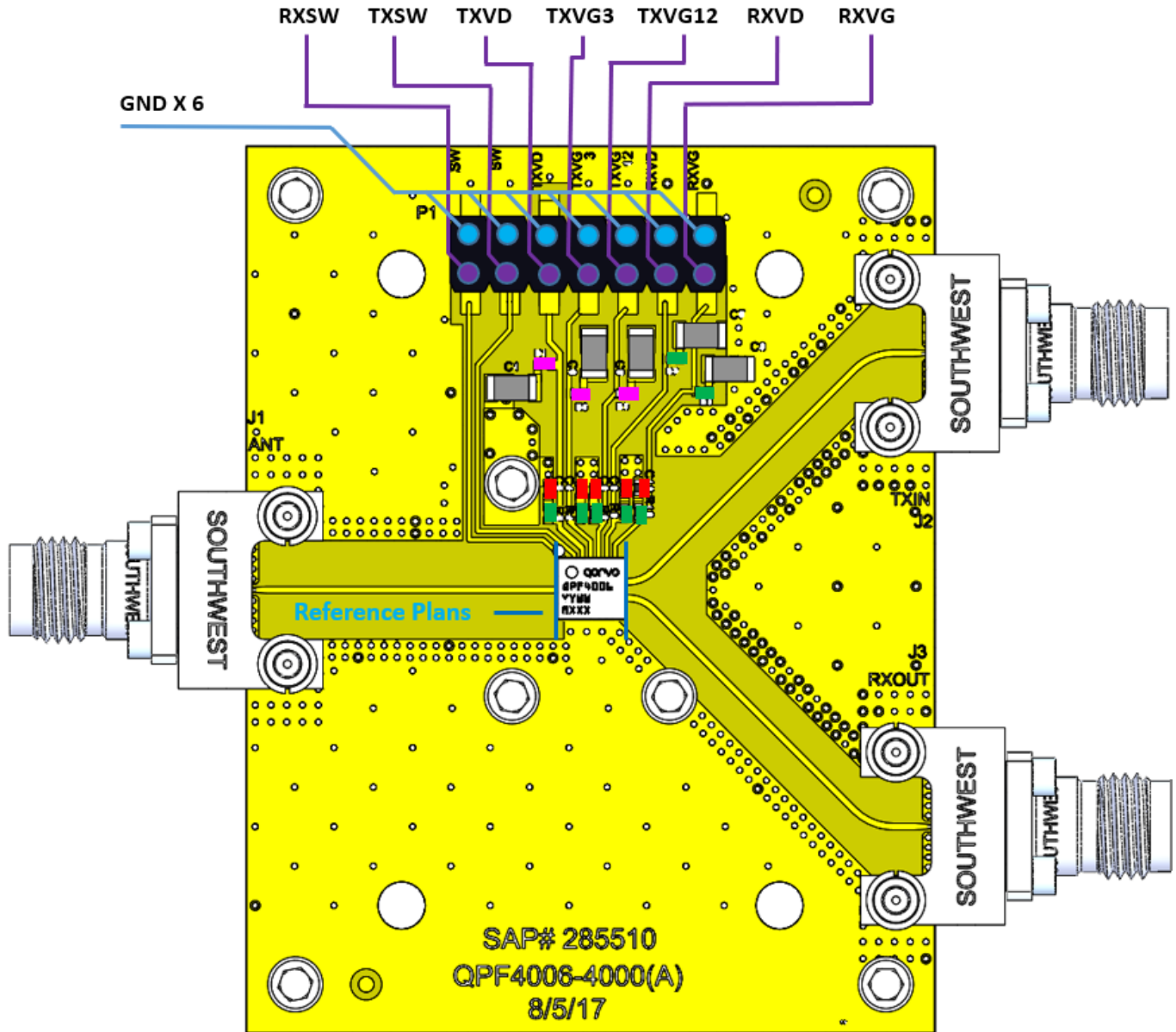

RF Layer is 0.008" thick Rogers Corp. RO4003C ($\epsilon_r = 3.35$). Metal layers are 0.5 oz. copper. The microstrip line at the connector interface is optimized for the Southwest Microwave end launch connector 1492-04A-5.

Ref. Des.	Component	Value	Manuf.	Remark
C2, C4, C6, C8, C10	SMT Cap.	CAP, 0402 1000pF +/-10% 50V 0402 X7R ROHS	Various	Red
C1, C3, C5, C7, C9	SMT Cap.	CAP, 1206 1.0uF +/-10% 50V X7R ROHS	Various	Grey
R2, R4, R6 - R10	SMT Res.	RES, 0402 5.1 OHM, 5% 50V, ROHS	Various	Green
R1, R3, R5	SMT Res.	RES, 0402 0 OHM, 5%, ROHS	Various	Pink

Application Circuit

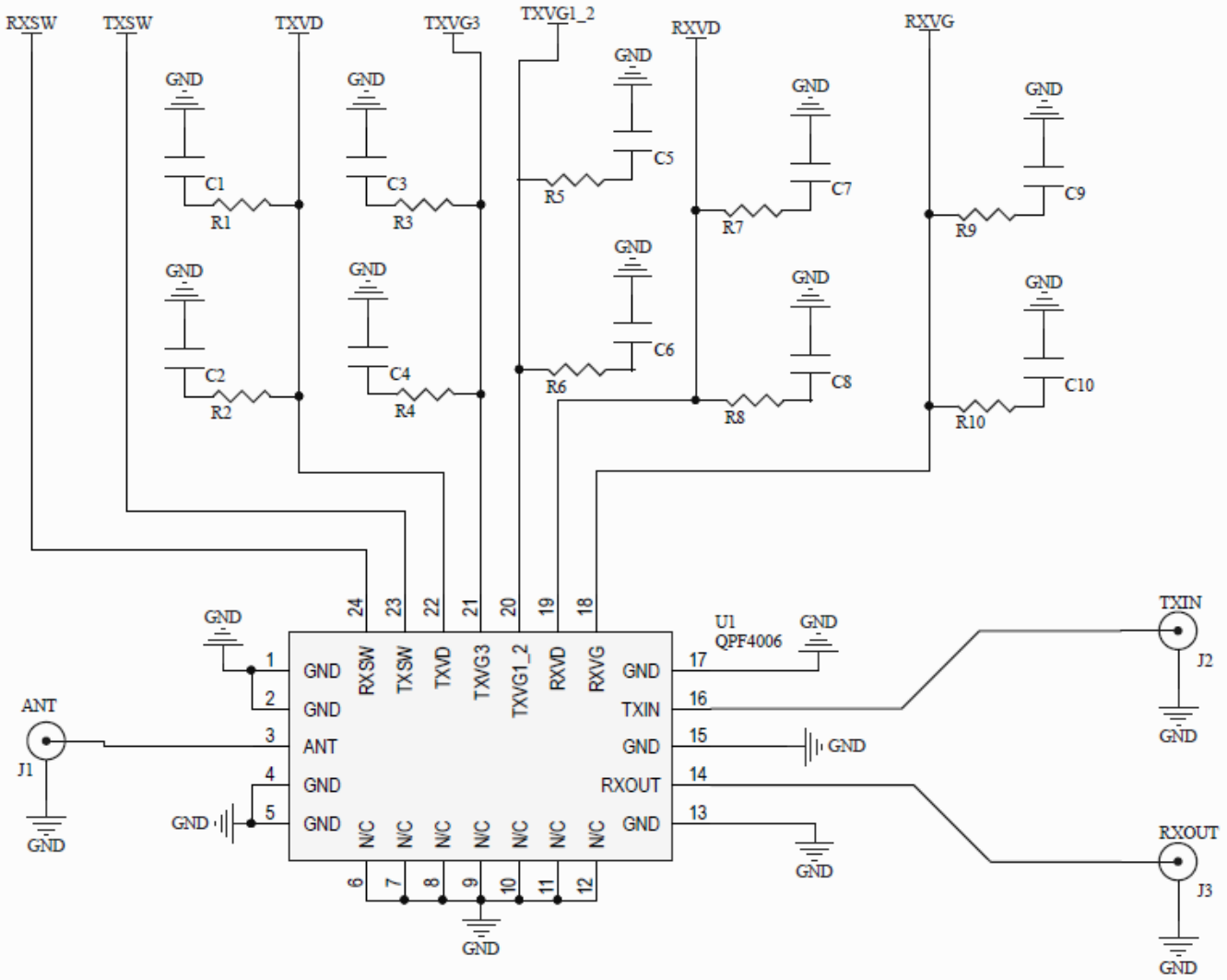

Bias-up Procedure

1. Set drain supply TXVD limit to 700 mA, RXVD limit to 50 mA, gate and control supply limit to 10 mA each.
2. Set TXVG12, TXVG3, RXVG to -5 V
3. Set TXSW = 20 V (or 0 V), RXSW = 0 V (or 20 V)
4. Set VD = +20 V
5. For TX, adjust TXVG12 to get TXID12 current, then adjust TXVG3 to achieve required total drain current; For RX, adjust RXVG to achieve required drain current.
6. Apply RF signal

Bias-down Procedure

1. Turn off RF signal
2. Set TXVG12, TXVG3 and RXVG to -5 V
3. Set VD = 0 V
4. Turn off drain supply
5. Turn off TXSW, RXSW
6. Turn off gate supply

Thermal and Reliability Information

Parameter	Values	Units	Conditions
Thermal Resistance (θ_{JC}), Quiescent, TX ^(1,2,3)	14.9	°C/W	TX on, RX off, CW, $V_D = +20\text{ V}$, $I_{DQ} = 159\text{ mA}$, $T_{BASE} = 85\text{ °C}$ RF off, $P_{DISS} = 3.18\text{ W}$
Channel Temperature (T_{CH}), Quiescent, TX	132.4	°C	
Thermal Resistance (θ_{JC}), Under Drive, TX ^(1,2,3)	10.7	°C/W	TX on, RX off, CW, $V_D = +20\text{ V}$, $T_{BASE} = 85\text{ °C}$, Freq = 39 GHz, $P_{IN} = 10\text{ dBm}$, $P_{OUT} = 25\text{ dBm}$, $I_{D_DRIVE} = 0.25\text{ A}$, $P_{DISS} = 4.69\text{ W}$
Channel Temperature (T_{CH}), Under Drive, TX	135.2	°C	
Thermal Resistance (θ_{JC}), Quiescent, RX ^(1,2,3)	67.0	°C/W	RX on, TX off, CW, $V_D = +20\text{ V}$, $I_{DQ} = 15\text{ mA}$ $T_{BASE} = 85\text{ °C}$ RF off, $P_{DISS} = 0.3\text{ W}$
Channel Temperature (T_{CH}), Quiescent, RX	105.1	°C	

Notes:

1. Thermal resistance is measured to package backside
2. Base or ambient temperature is 85 °C
3. Refer to the following document: [GaN Device Channel Temperature, Thermal Resistance, and Reliability Estimates](#)

Solderability

1. Compatible with the latest version of J-STD-020, Lead-free solder, 260 °C.
2. This package is non-hermetic, and therefore cannot be subjected to aqueous washing. The use of no-clean solder to avoid washing is highly recommended.

Recommended Soldering Temperature Profile

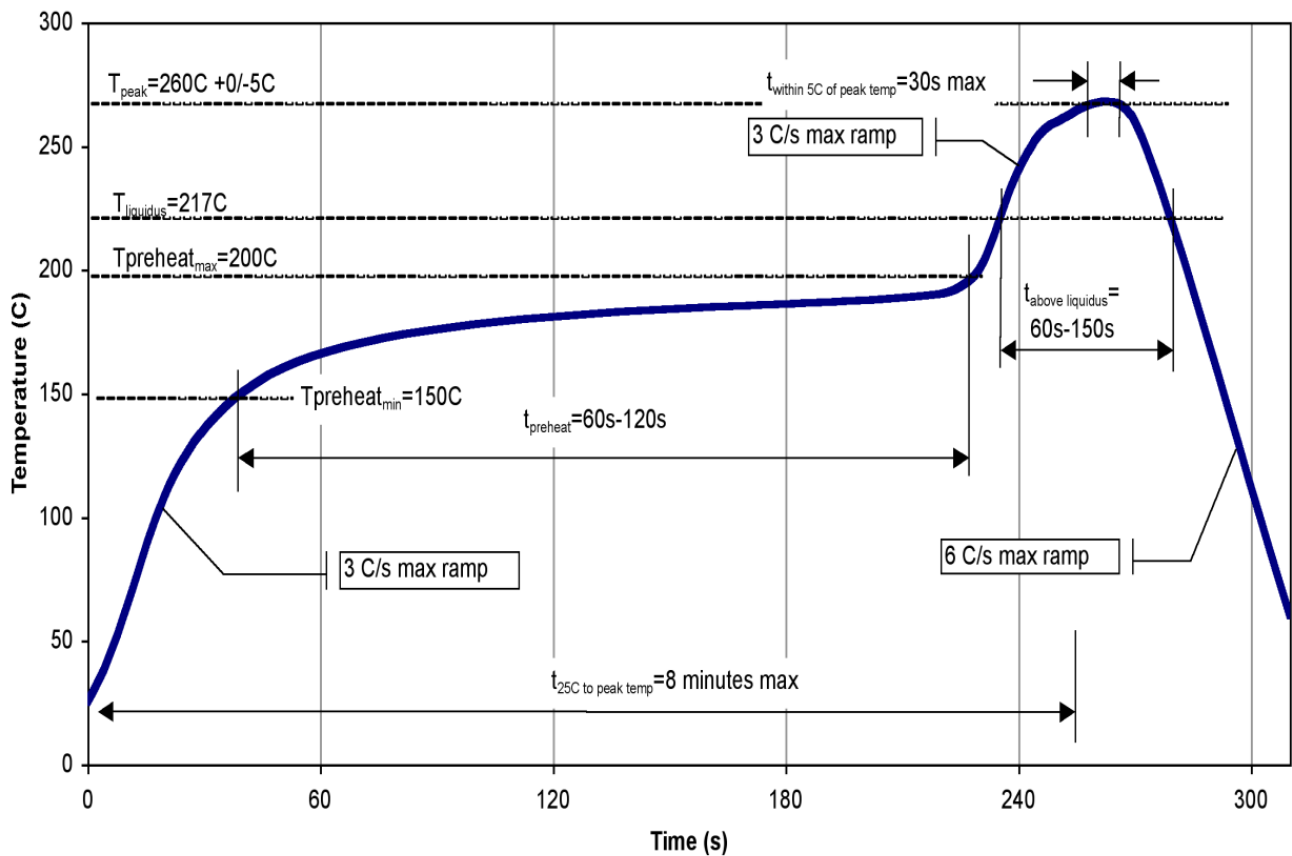

Tape and Reel Information

Standard T/R size = 250 pieces on a 7" reel.

Material		Cavity (mm)				Distance Between Centerline (mm)		Carrier Tape (mm)	Cover Carrier (mm)
Vendor	Vendor P/N	Length (A0)	Width (B0)	Depth (K0)	Pitch (P1)	Length direction (P2)	Width Direction (F)	Width (W)	Width (W)
Tek-Pak	QFN0400X0450C	4.25	4.75	2.1	8.0	2.00	5.50	12.0	9.20

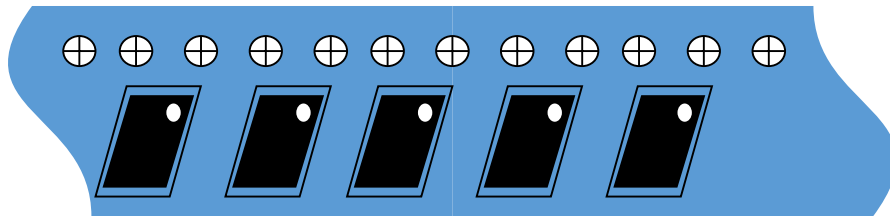
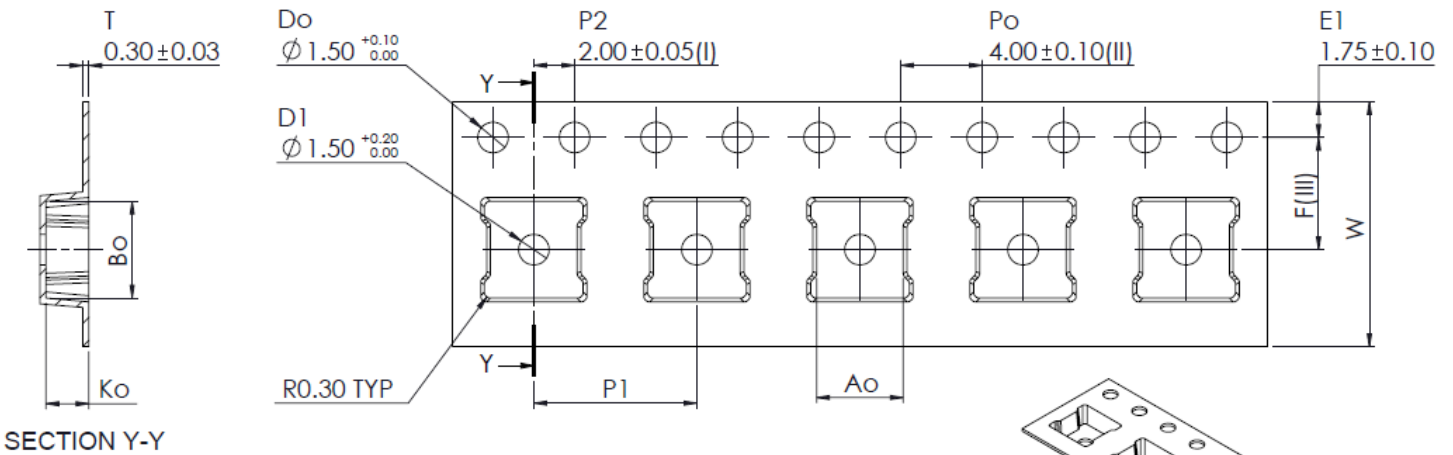

Handling Precautions

Parameter	Rating	Standard
ESD – Human Body Model (HBM)	0B	ESDA / JEDEC JS-001-2012
ESD – Charged Device Model (CDM)	C3	ESDA / JEDEC JS-002-2014
MSL – Convection Reflow 260 °C	3	JEDEC standard IPC/JEDEC J-STD-020



Caution!
ESD-Sensitive Device

RoHS Compliance

This product is compliant with the 2011/65/EU RoHS directive (Restrictions on the Use of Certain Hazardous Substances in Electrical and Electronic Equipment), as amended by Directive 2015/863/EU. This product also has the following attributes:

- Lead Free
- Antimony Free
- TBBP-A (C₁₅H₁₂Br₄O₂) Free
- PFOS Free

Contact Information

For the latest specifications, additional product information, worldwide sales and distribution locations:

Tel: 1-844-890-8163

Web: www.qorvo.com

Email: customer.support@qorvo.com

Important Notice

The information contained in this Data Sheet and any associated documents (“Data Sheet Information”) is believed to be reliable; however, Qorvo makes no warranties regarding the Data Sheet Information and assumes no responsibility or liability whatsoever for the use of said information. All Data Sheet Information is subject to change without notice. Customers should obtain and verify the latest relevant Data Sheet Information before placing orders for Qorvo® products. Data Sheet Information or the use thereof does not grant, explicitly, implicitly or otherwise any rights or licenses to any third party with respect to patents or any other intellectual property whether with regard to such Data Sheet Information itself or anything described by such information.

DATA SHEET INFORMATION DOES NOT CONSTITUTE A WARRANTY WITH RESPECT TO THE PRODUCTS DESCRIBED HEREIN, AND QORVO HEREBY DISCLAIMS ANY AND ALL WARRANTIES WITH RESPECT TO SUCH PRODUCTS WHETHER EXPRESS OR IMPLIED BY LAW, COURSE OF DEALING, COURSE OF PERFORMANCE, USAGE OF TRADE OR OTHERWISE, INCLUDING THE IMPLIED WARRANTIES OF MERCHANTABILITY AND FITNESS FOR A PARTICULAR PURPOSE. Without limiting the generality of the foregoing, Qorvo® products are not warranted or authorized for use as critical components in medical, life-saving, or life-sustaining applications, or other applications where a failure would reasonably be expected to cause severe personal injury or death. Applications described in the Data Sheet Information are for illustrative purposes only. Customers are responsible for validating that a particular product described in the Data Sheet Information is suitable for use in a particular application.

© 2021 Qorvo US, Inc. All rights reserved. This document is subject to copyright laws in various jurisdictions worldwide and may not be reproduced or distributed, in whole or in part, without the express written consent of Qorvo US, Inc. | QORVO® is a registered trademark of Qorvo US, Inc.