

Product Description

Qorvo’s QPA1003P is a wideband high power MMIC amplifier fabricated on Qorvo’s production 0.15um GaN on SiC process (QGaN15). The QPA1003P operates from 1 – 8 GHz and typically provides 10 W saturated output power with power-added efficiency of 30% and large-signal gain of 25 dB. This combination of wideband performance provides the flexibility designers are looking for to improve system performance while reducing size and cost.

The QPA1003P is matched to 50 Ω with integrated DC blocking capacitors on both RF I/O ports simplifying system integration. The wideband performance makes it ideally suited in support of test instrumentation and electronic warfare, as well as, supporting multiple radar and communication bands.

Lead-free and RoHS compliant.

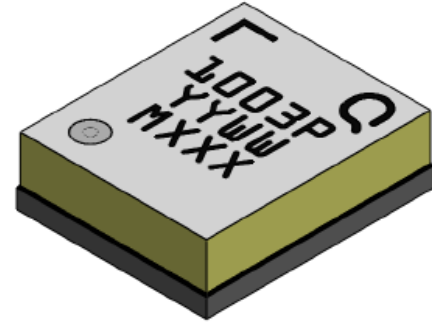

Product Features

- Frequency Range: 1 – 8 GHz
- P_{OUT}: 40 dBm (P_{IN} = 15 dBm)
- PAE: 30 % (P_{IN} = 15 dBm)
- Large Signal Gain: 25 dB (P_{IN} = 15 dBm)
- Small Signal Gain: 30 dB
- Bias: V_D = +28 V, I_{DQ} = 650 mA
- Package Dimensions: 5.0 x 6.0 x 1.76 mm
- Process Technology: QGaN15

Performance is typical across frequency. Please reference electrical specification table and data plots for more details.

Functional Block Diagram

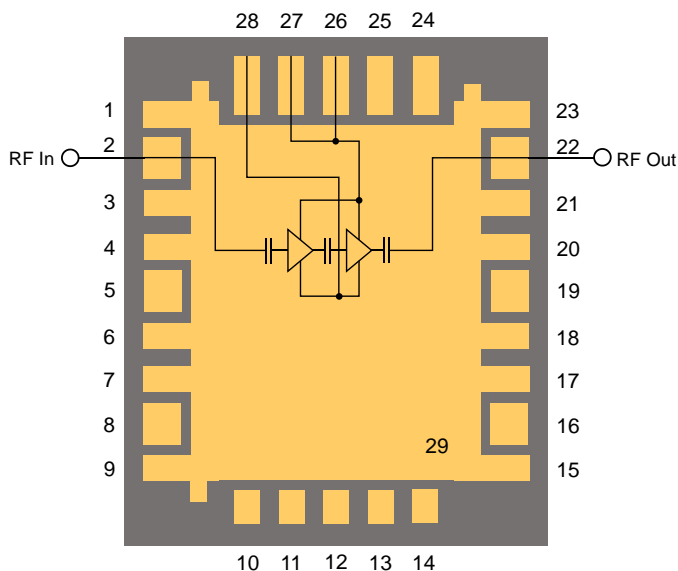

Applications

- Electronic Warfare (EW)
- Radar
- Communications
- Test Instrumentation

Ordering Information

Part No.	Description
QPA1003P	1 – 8 GHz 10 W GaN Power Amplifier
QPA1003PEVBP01	Evaluation Board



Absolute Maximum Ratings

Parameter	Value / Range
Drain Voltage (V_D)	+29.5 V
Gate Voltage Range (V_G)	-8 to 0 V
Drain Current	1300 mA
Forward Gate Current (I_G)	See I_{G_MAX} plot
Power Dissipation (P_{DISS}), 85 °C, CW	30 W
Input Power (P_{IN}): CW, 50 Ω , $V_D = +28$ V, $I_{DQ} = 650$ mA, 85 °C	18 dBm
Input Power (P_{IN}): CW, VSWR 3:1, $V_D = +28$ V, $I_{DQ} = 650$ mA, 85 °C	18 dBm
Mounting Temperature (30 Seconds)	260 °C
Storage Temperature	-55 to 150 °C

Operation of this device outside the parameter ranges given above may cause permanent damage. These are stress ratings only, and functional operation of the device at these conditions is not implied.

Electrical Specifications

Test conditions unless otherwise noted: 25 °C, $V_D = +28$ V, $I_{DQ} = 650$ mA, CW.

Parameter	Min	Typ	Max	Units
Operational Frequency Range	1	-	8	GHz
Output Power @ $P_{IN} = 15$ dBm	Frequency = 1 GHz	39.7	-	dBm
	Frequency = 4 GHz	40.7	-	
	Frequency = 8 GHz	39.9	-	
Power Added Efficiency @ $P_{IN} = 15$ dBm	Frequency = 1 GHz	47.5	-	%
	Frequency = 4 GHz	35	-	
	Frequency = 8 GHz	30.5	-	
Small Signal Gain	Frequency = 1 GHz	31.5	-	dB
	Frequency = 4 GHz	32.7	-	
	Frequency = 8 GHz	31.4	-	
Input Return Loss	Frequency = 1 GHz	12.7	-	dB
	Frequency = 4 GHz	12.1	-	
	Frequency = 8 GHz	9.8	-	
Output Return Loss	Frequency = 1 GHz	17.5	-	dB
	Frequency = 4 GHz	6.9	-	
	Frequency = 8 GHz	11.4	-	
Small Signal Gain Temperature Coefficient	-	-0.04	-	dB/°C
Output Power Temperature Coefficient	-	-0.014	-	dBm/°C

Recommended Operating Conditions

Parameter	Value / Range
Drain Voltage (V_D)	+28 V
Drain Current (I_{DQ})	650 mA
Gate Voltage Range (V_G)	-2.9 to -2.0 V
Temperature (T_{BASE})	-40 to 85 °C

Electrical specifications are measured at specified test conditions. Specifications are not guaranteed over all recommended operating conditions.

Performance Plots – Large Signal (CW)

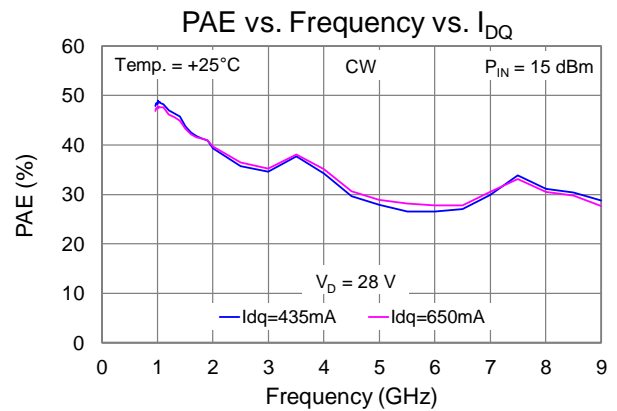
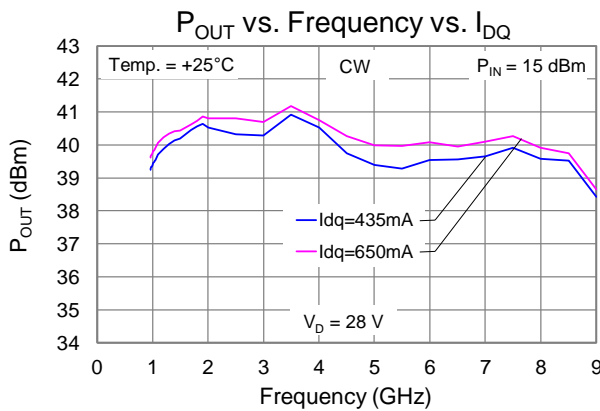
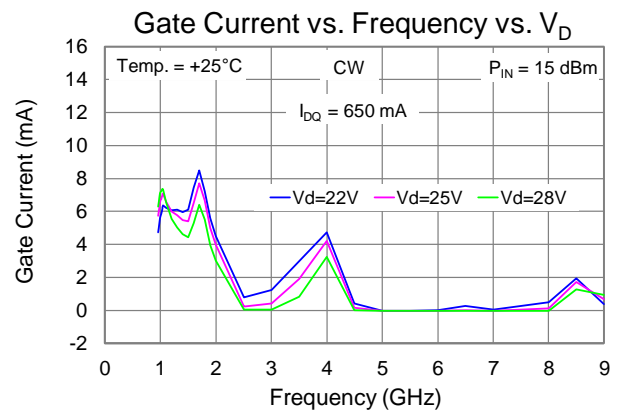
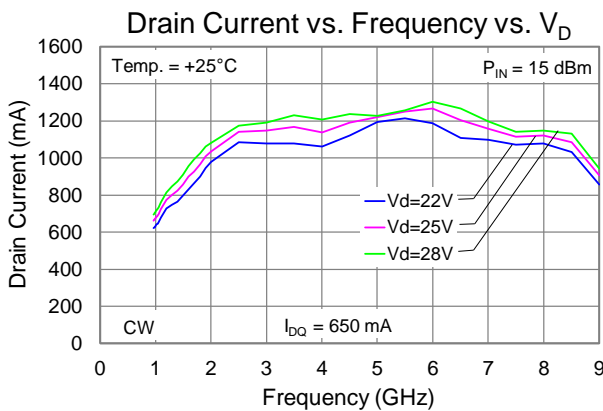
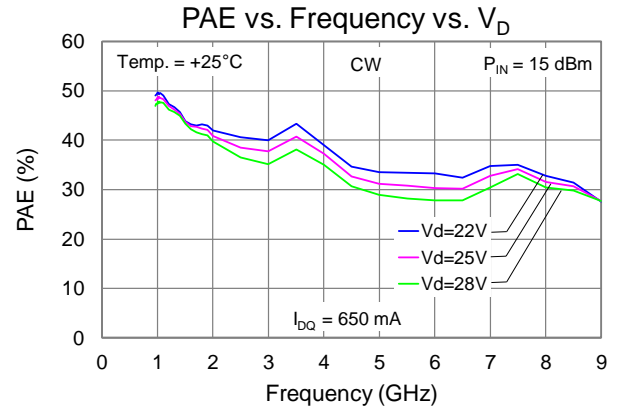
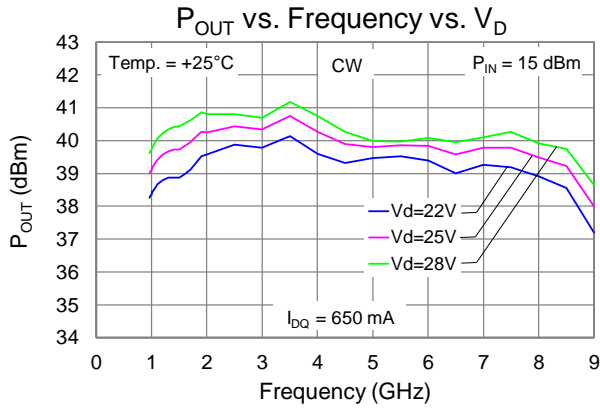

Performance Plots – Large Signal (CW)

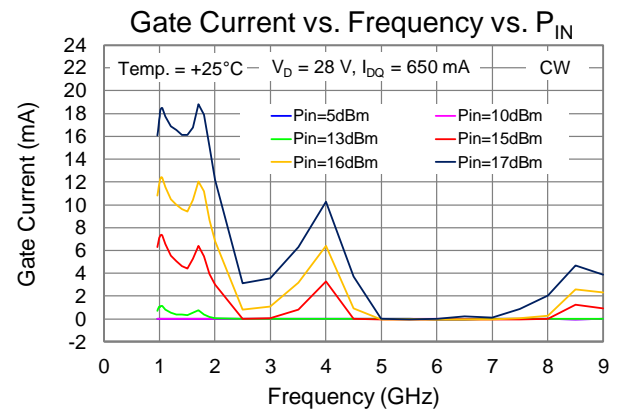
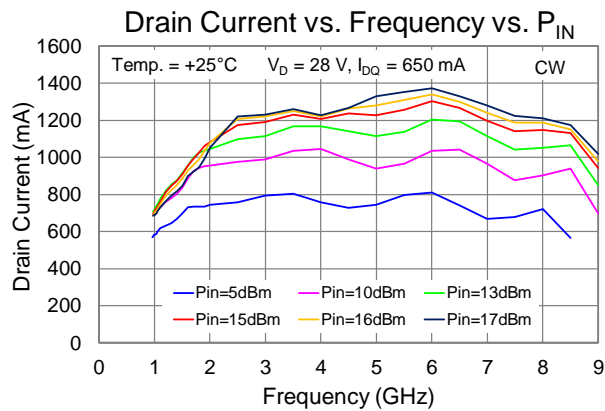
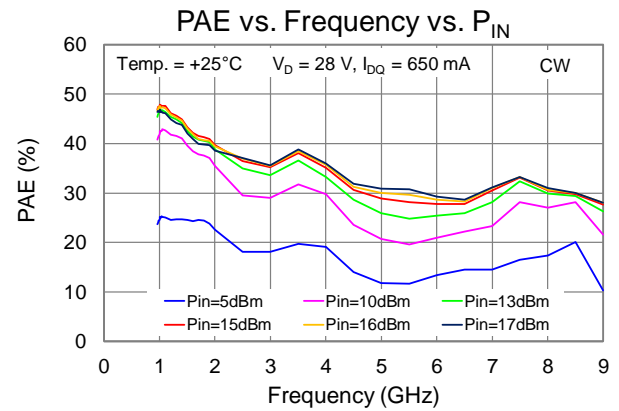
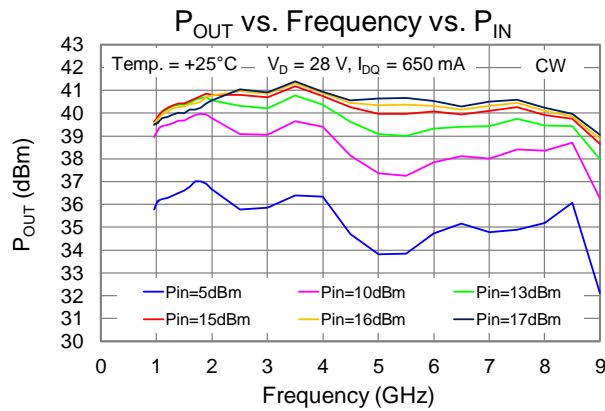
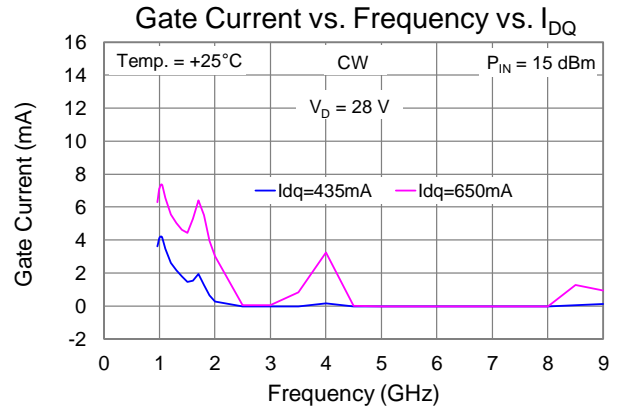
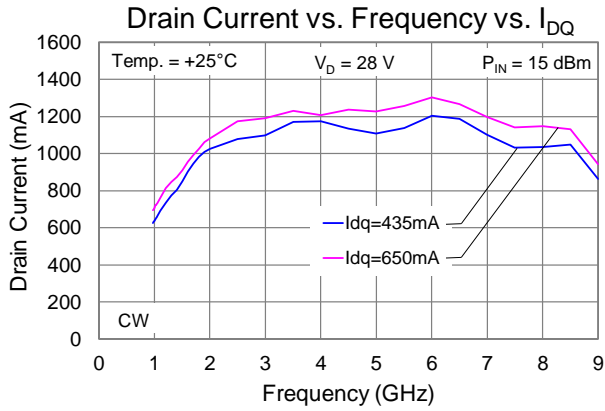

Performance Plots – Large Signal (CW)

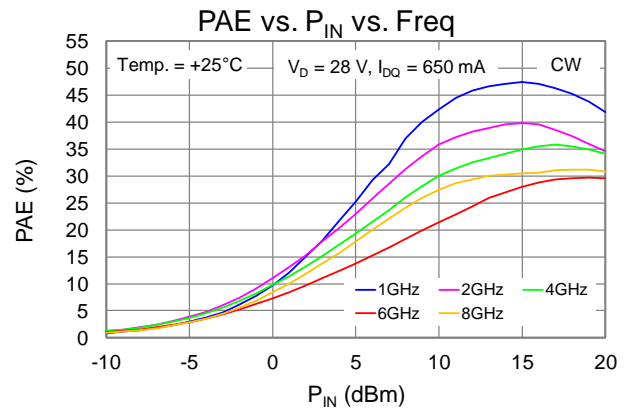
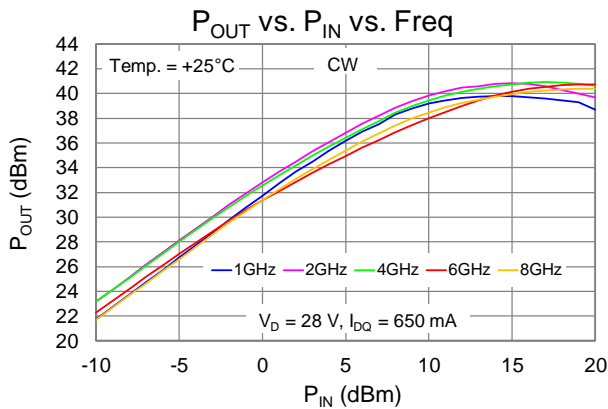
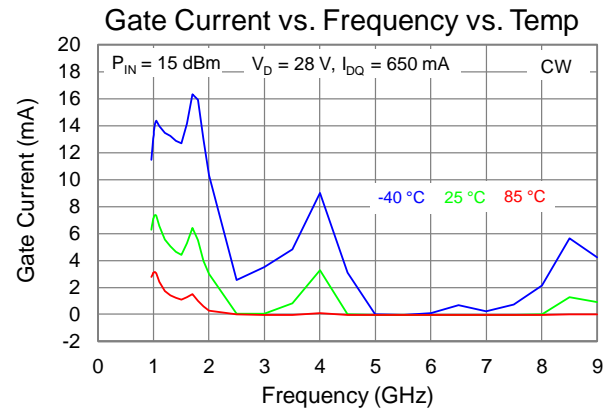
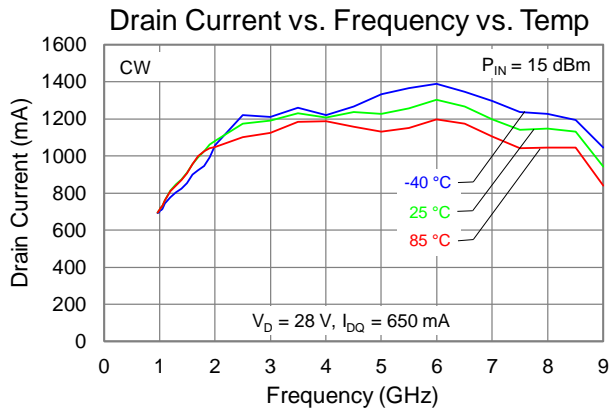
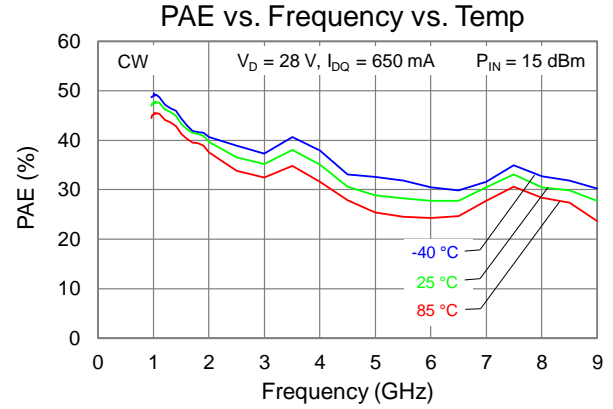
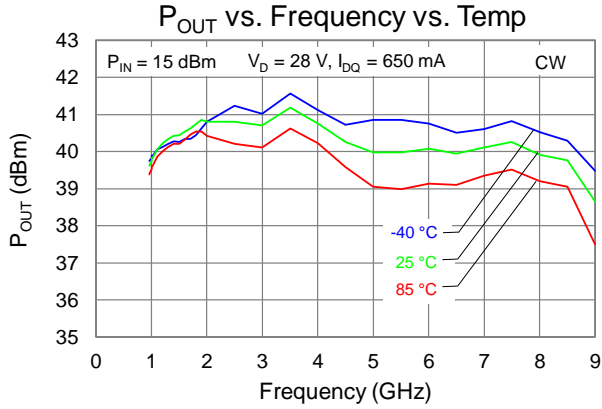

Performance Plots – Large Signal (CW)

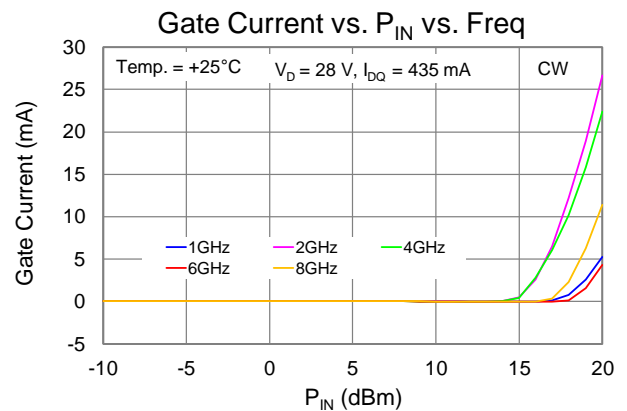
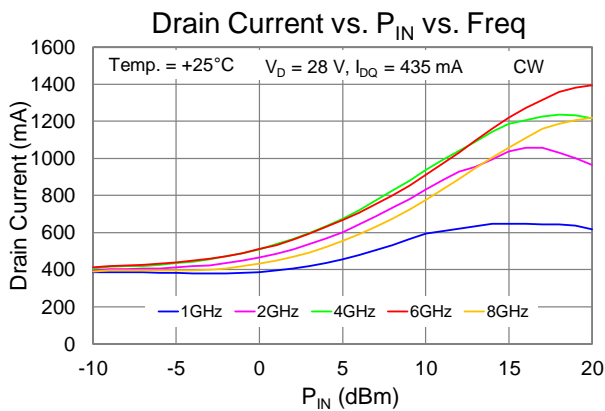
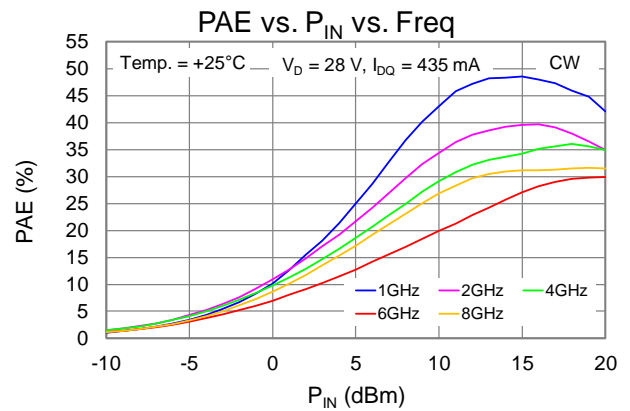
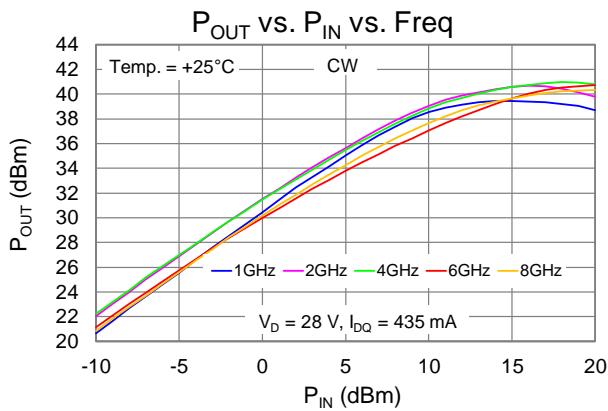
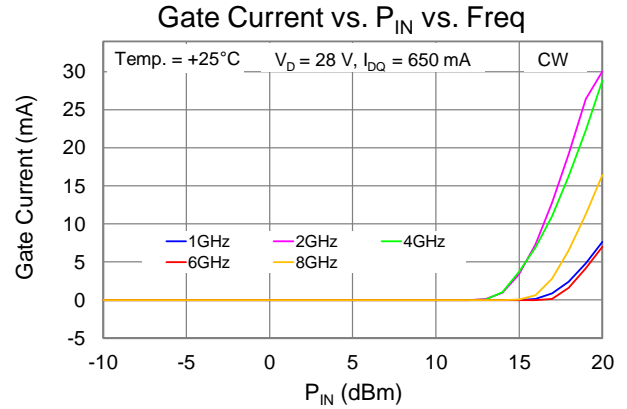
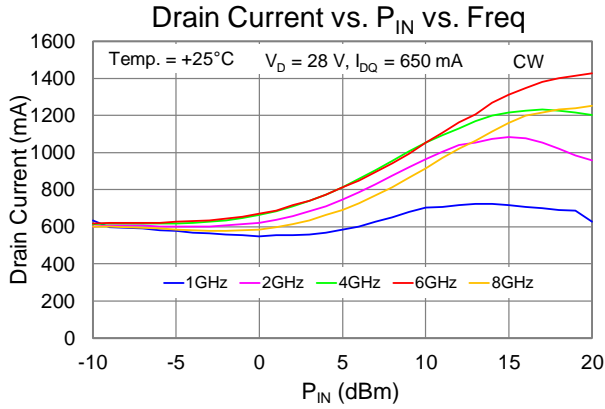

Performance Plots – Large Signal (CW)

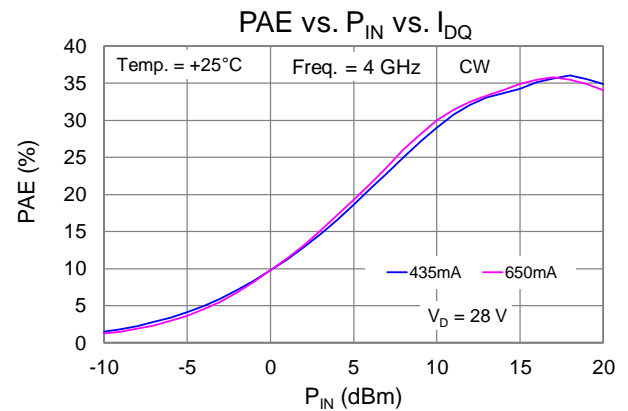
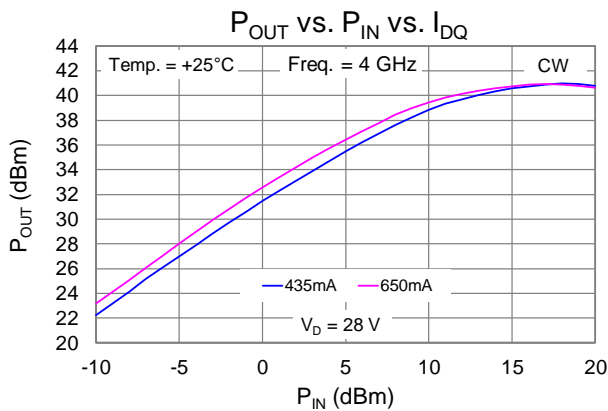
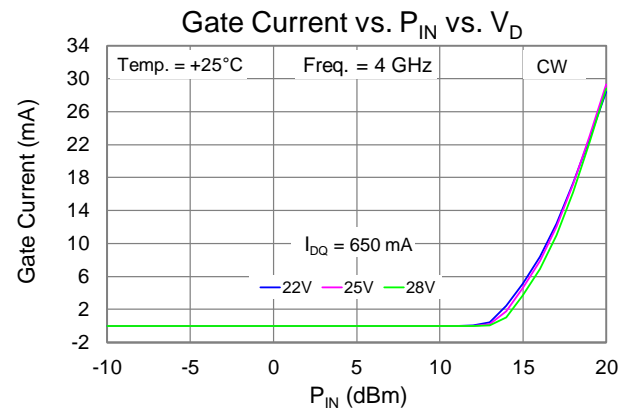
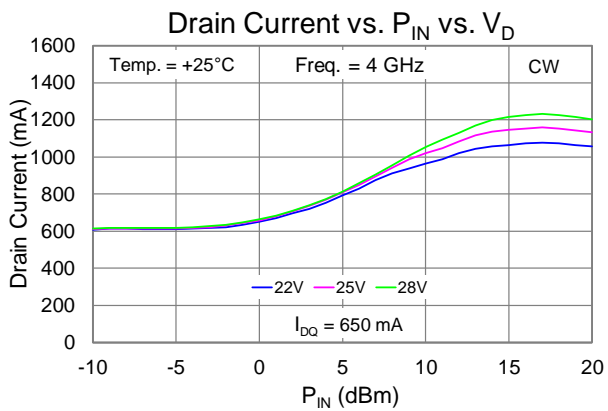
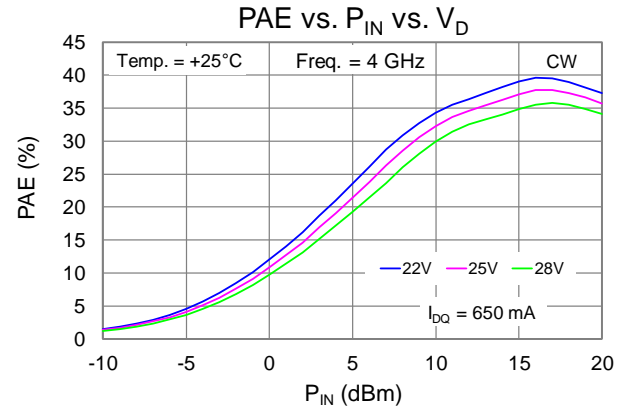
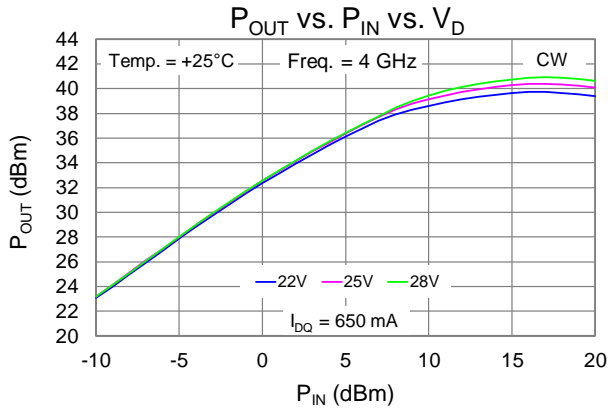

Performance Plots – Large Signal (CW)

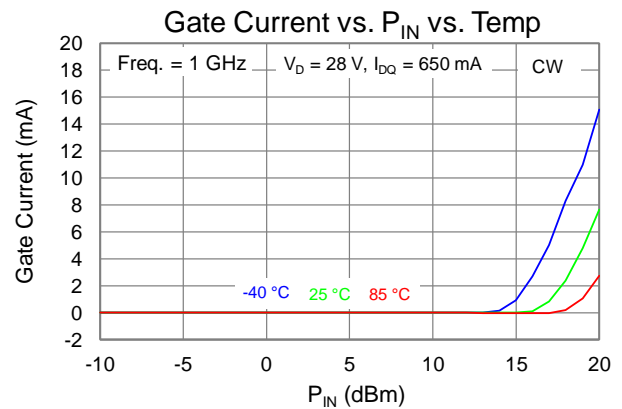
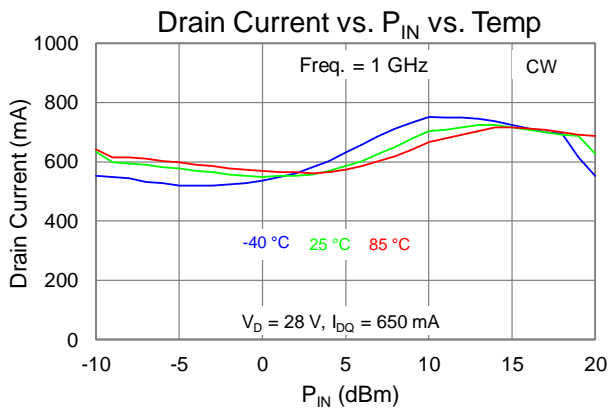
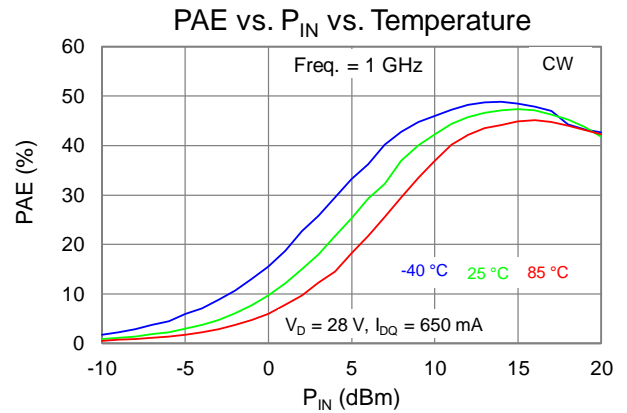
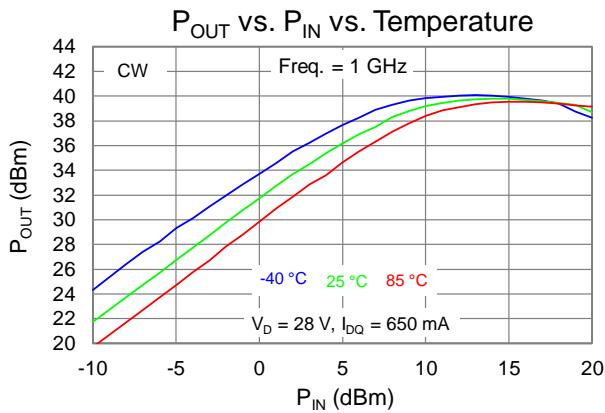
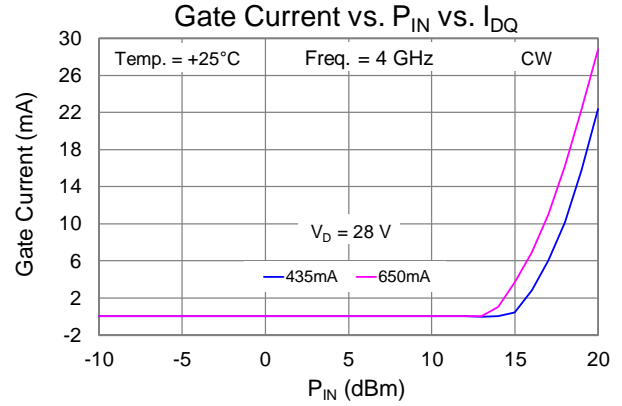
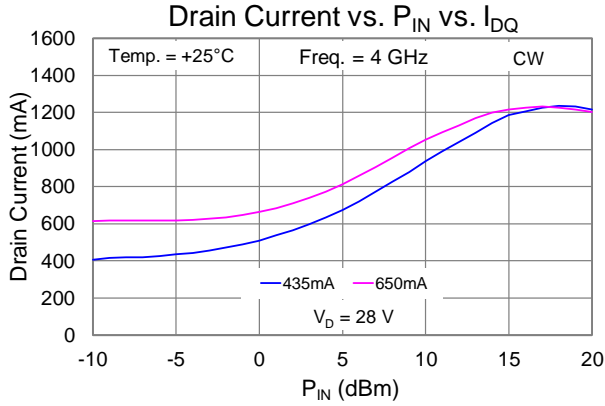

Performance Plots – Large Signal (CW)

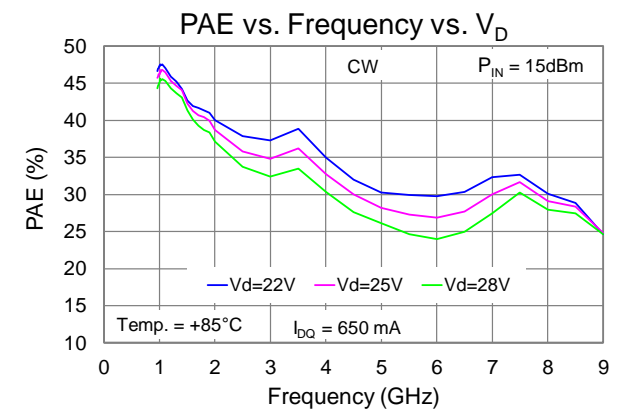
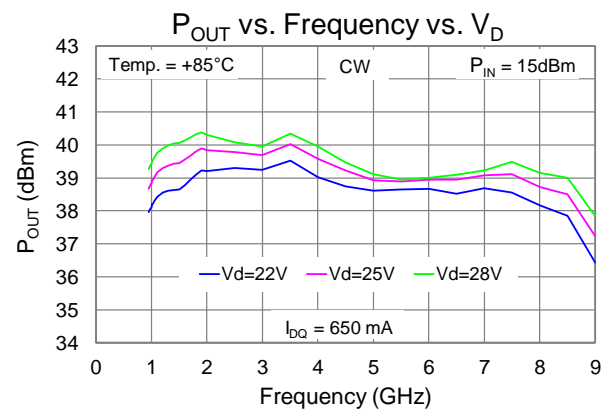
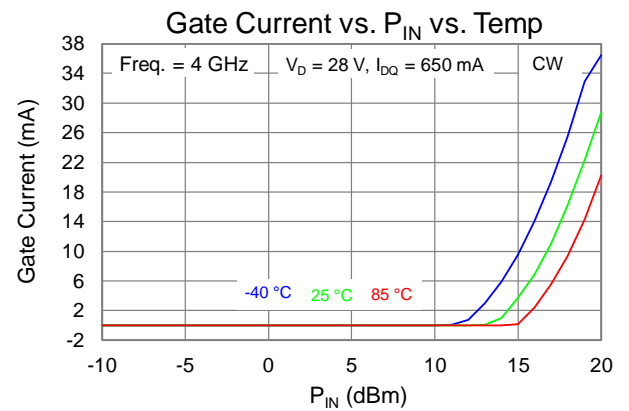
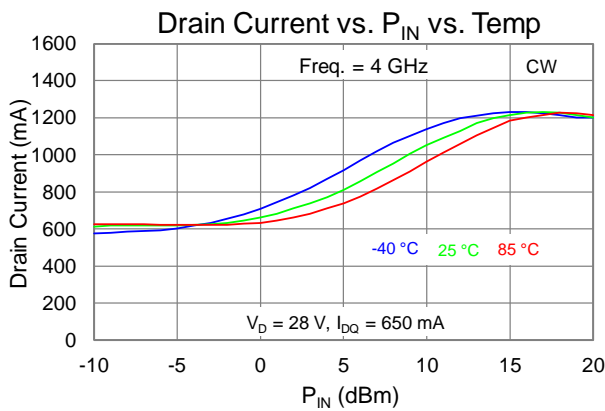
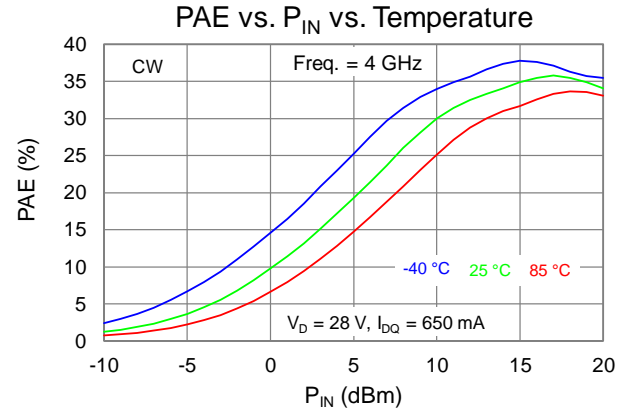
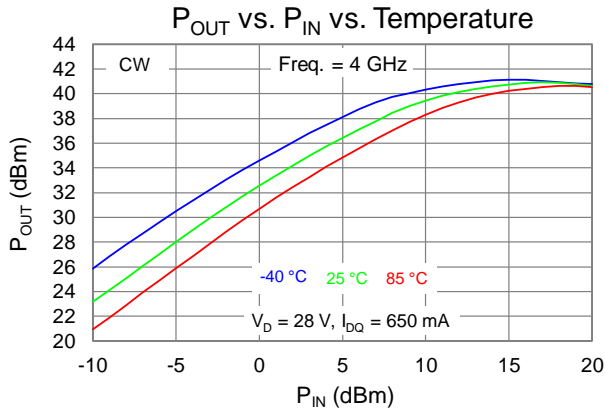

Performance Plots – Linearity

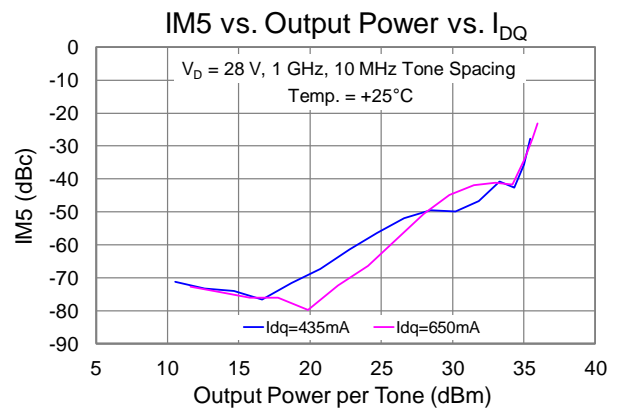
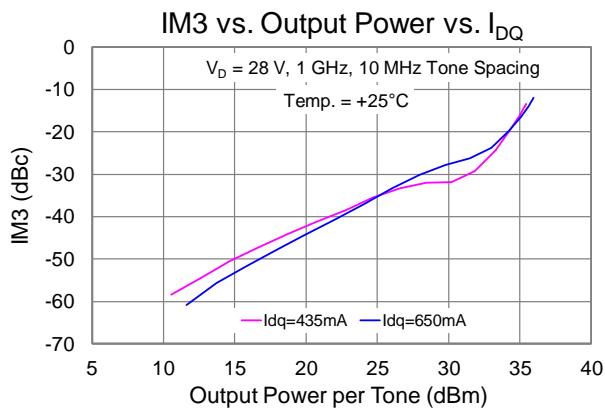
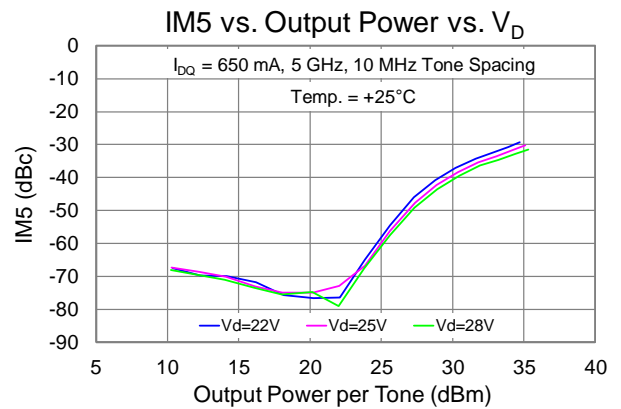
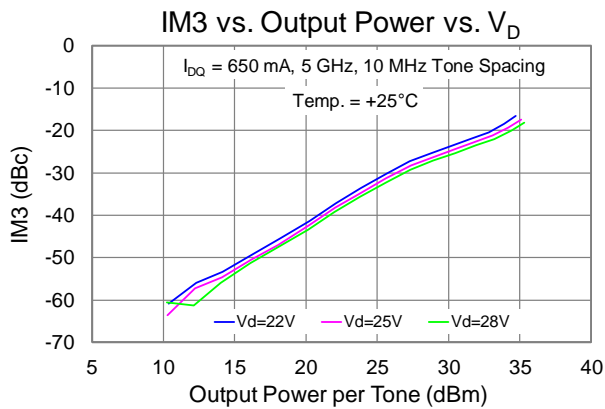
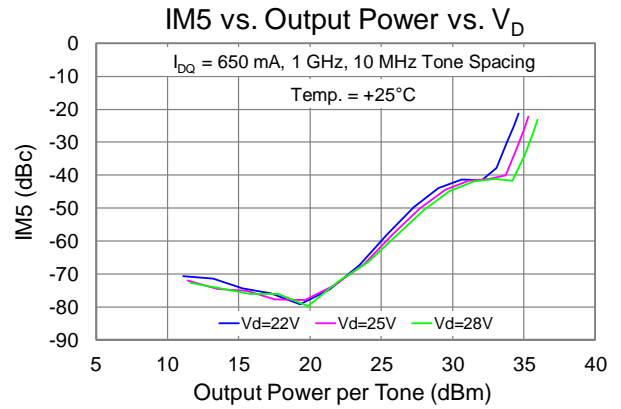
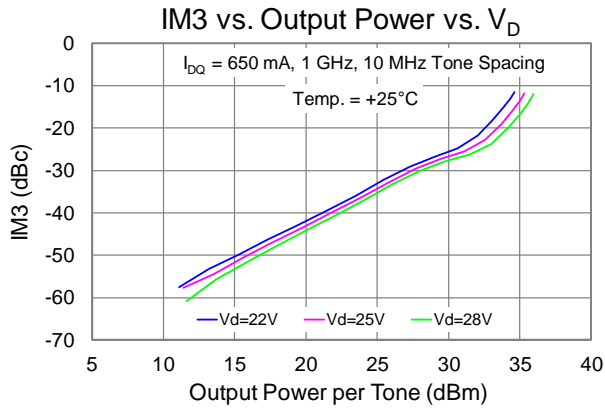

Performance Plots – Linearity

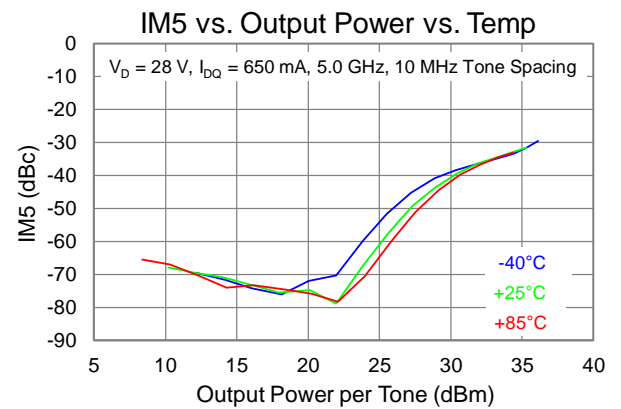
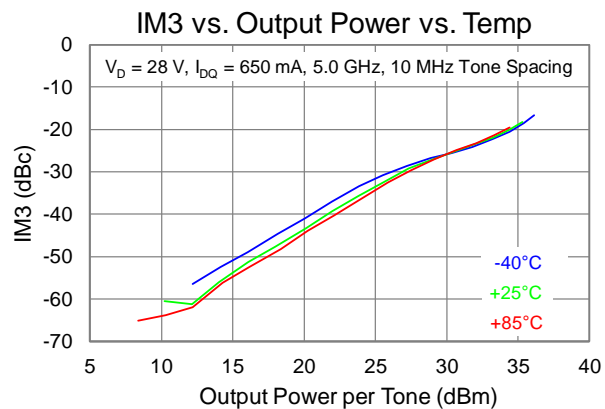
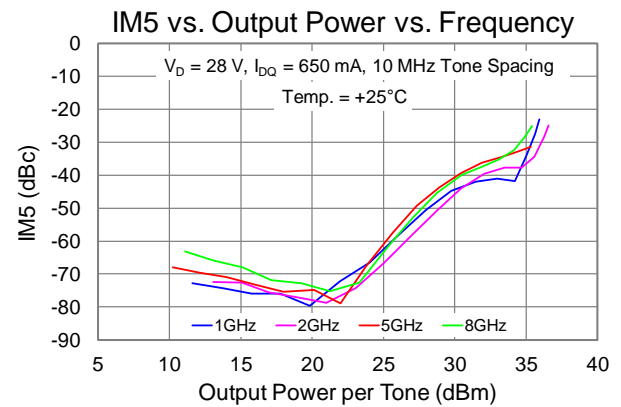
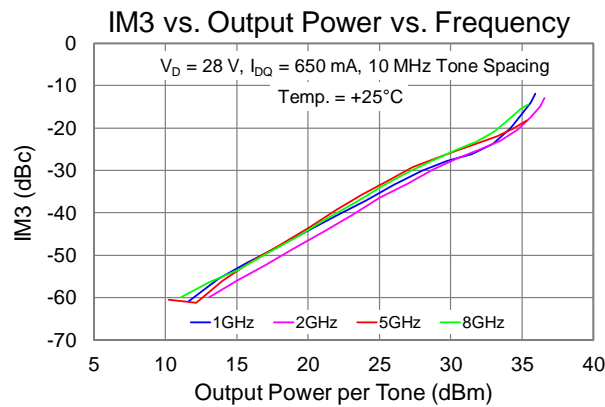
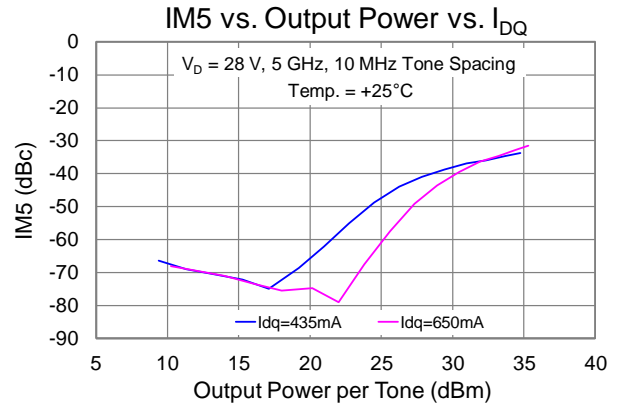
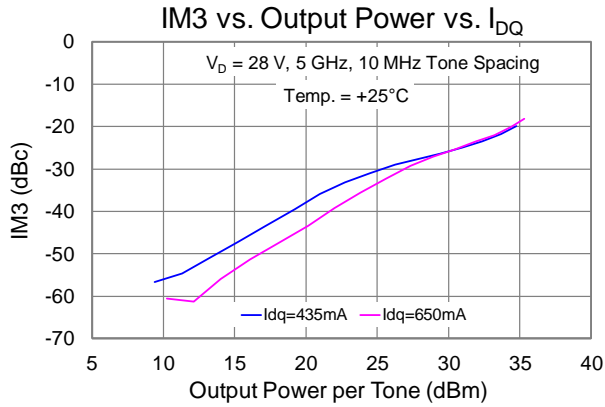

Performance Plots – Linearity

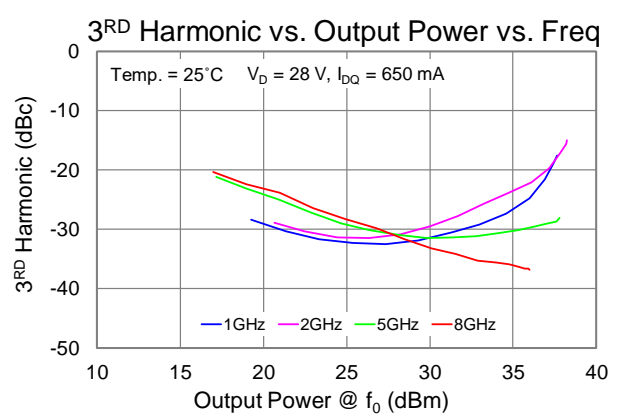
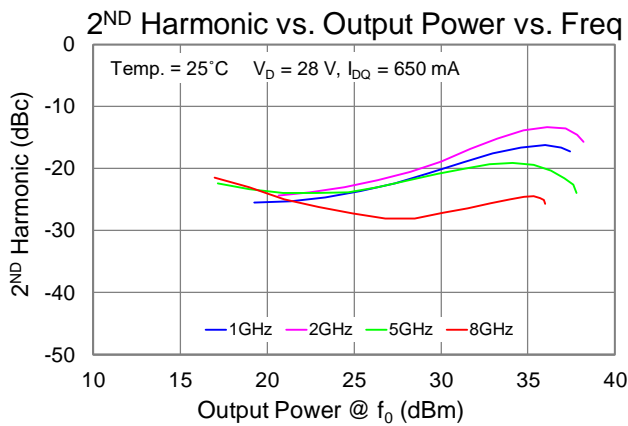
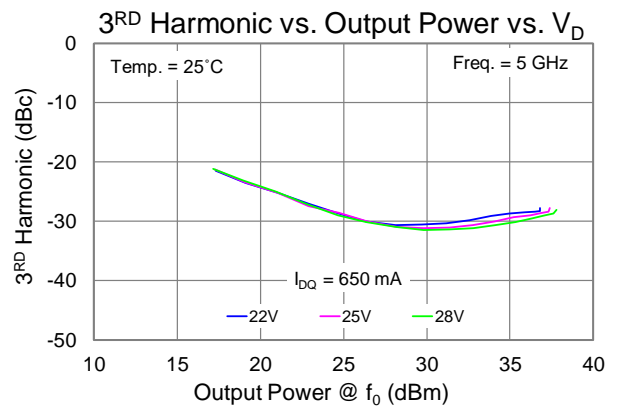
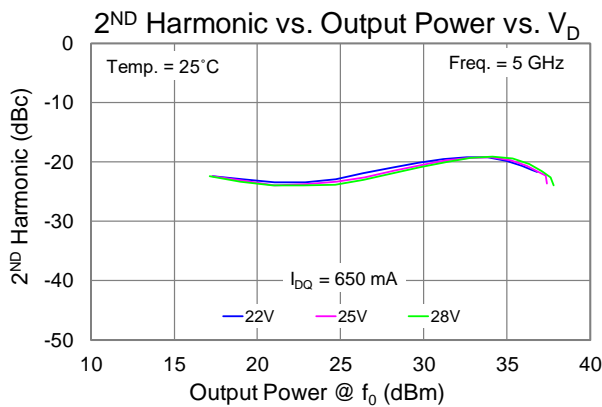
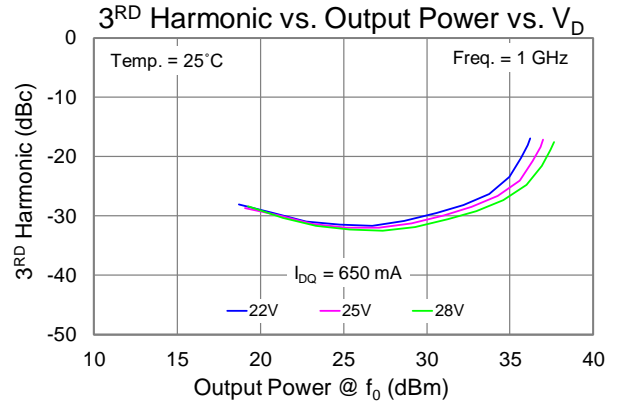
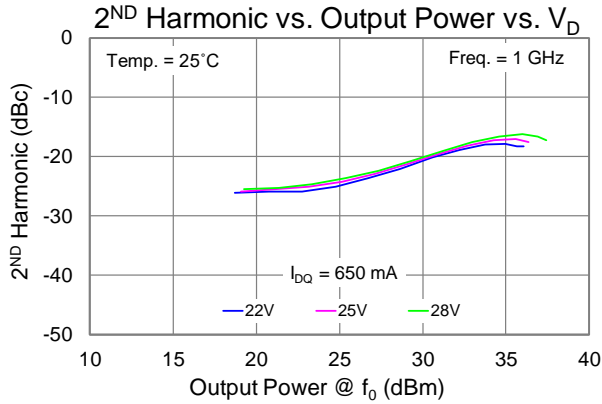

Performance Plots – Linearity

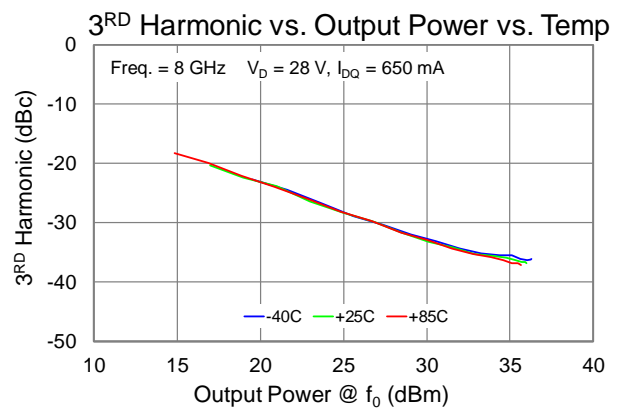
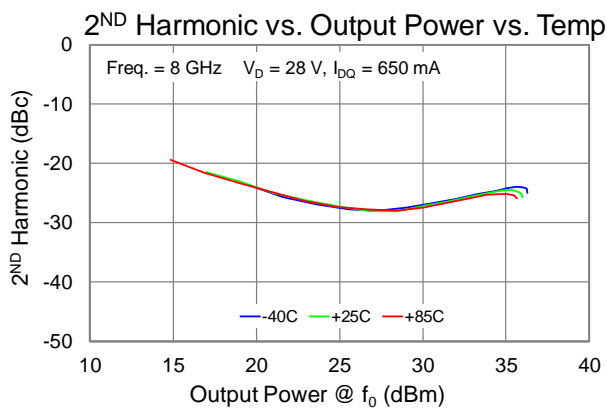
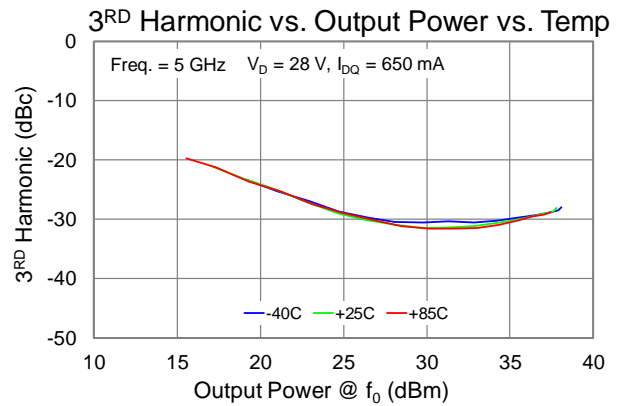
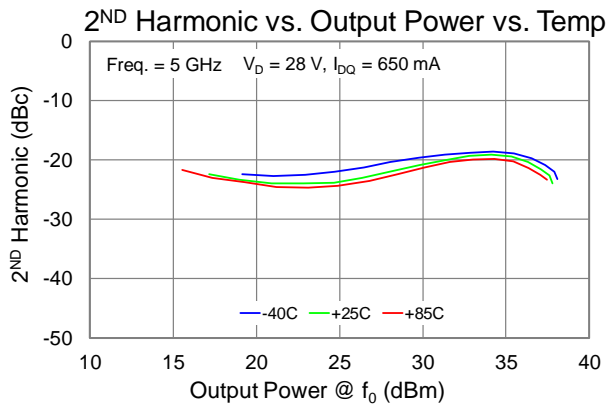
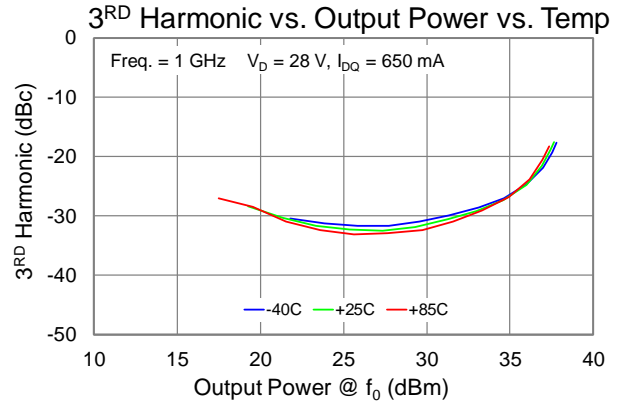
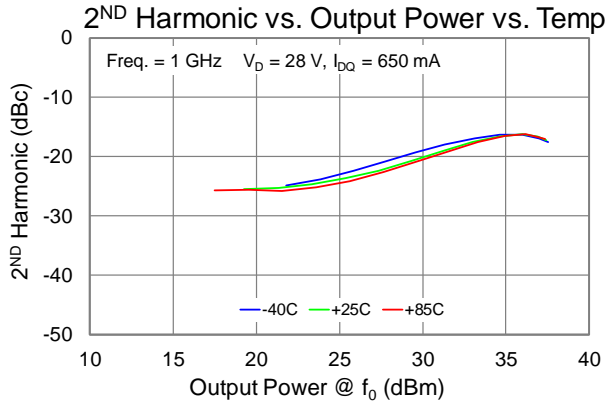

Performance Plots – Small Signal

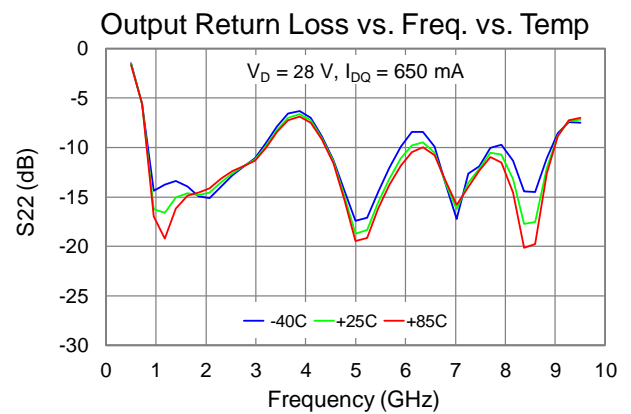
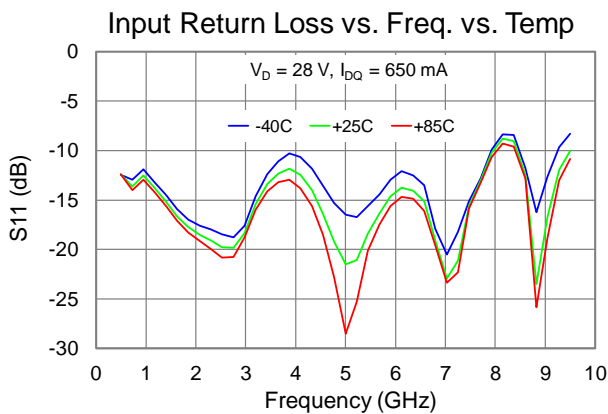
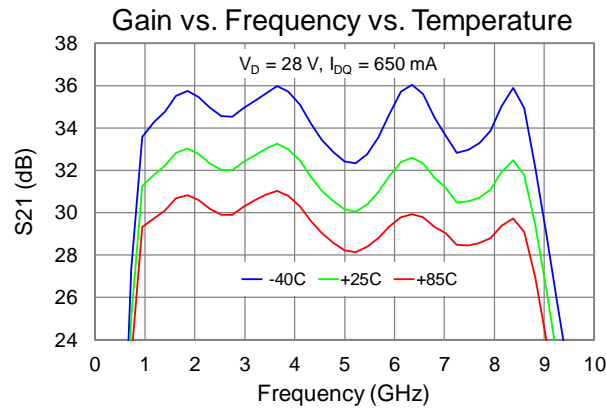
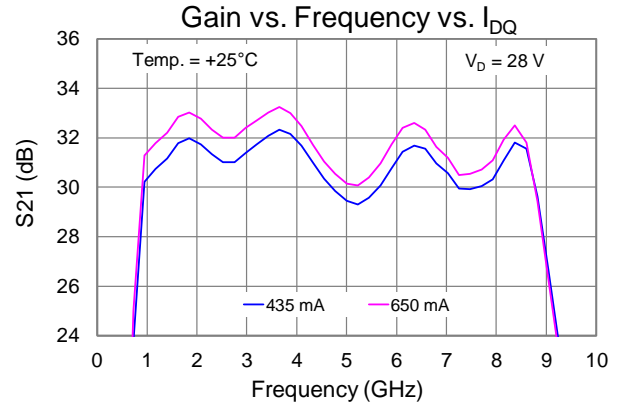
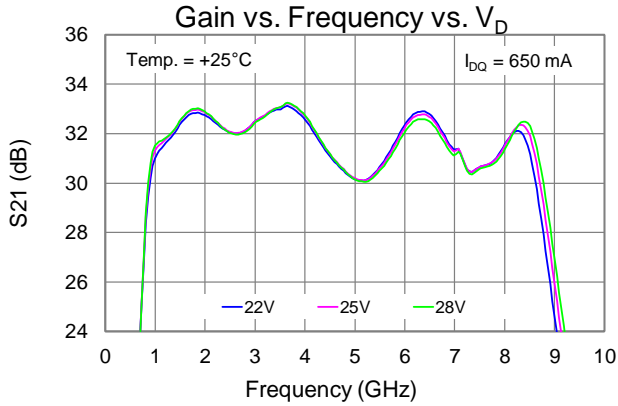

Thermal and Reliability Information

Parameter	Test Conditions	Value	Units
Thermal Resistance (θ_{JC}) ¹	$T_{BASE} = 85^\circ\text{C}$, $V_D = +28\text{ V (CW)}$ At $I_{DQ} = 650\text{ mA}$, $P_{DISS} = 18.2\text{ W}$	3.62	$^\circ\text{C/W}$
Channel Temperature (T_{CH}) (Quiescent) ²		151	$^\circ\text{C}$
Thermal Resistance (θ_{JC}) ¹	$T_{BASE} = 85^\circ\text{C}$, $V_D = +25\text{ V (CW)}$, Freq = 6.0 GHz, $P_{IN} = 15\text{ dBm}$, $I_{DQ} = 650\text{ mA}$, $I_{D_Drive} = 1.2\text{ A}$, $P_{OUT} = 39\text{ dBm}$, $P_{DISS} = 21\text{ W}$	4.19	$^\circ\text{C/W}$
Channel Temperature (T_{CH}) (Under RF drive) ²		173	$^\circ\text{C}$
Thermal Resistance (θ_{JC}) ¹	$T_{BASE} = 85^\circ\text{C}$, $V_D = +28\text{ V (CW)}$, Freq = 6.0 GHz, $P_{IN} = 15\text{ dBm}$, $I_{DQ} = 650\text{ mA}$, $I_{D_Drive} = 1.2\text{ A}$, $P_{OUT} = 39\text{ dBm}$, $P_{DISS} = 25\text{ W}$	4.16	$^\circ\text{C/W}$
Channel Temperature (T_{CH}) (Under RF drive) ²		189	$^\circ\text{C}$

Notes:

- Thermal resistance referenced to the back of the package.
- IR scan equivalent. Refer to the following document: [GaN Device Channel Temperature, Thermal Resistance, and Reliability Estimates](#)

Power Dissipation and Maximum Gate Current

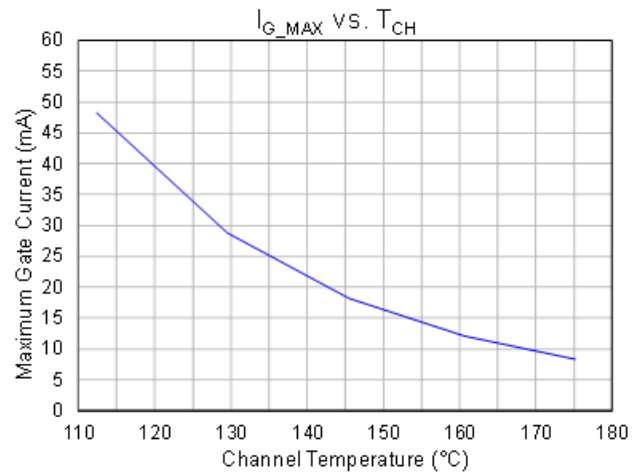
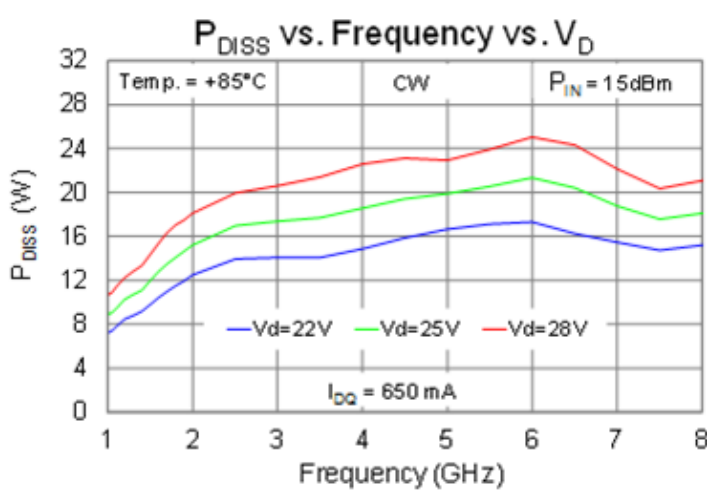

Applications Circuit and Pin Layout

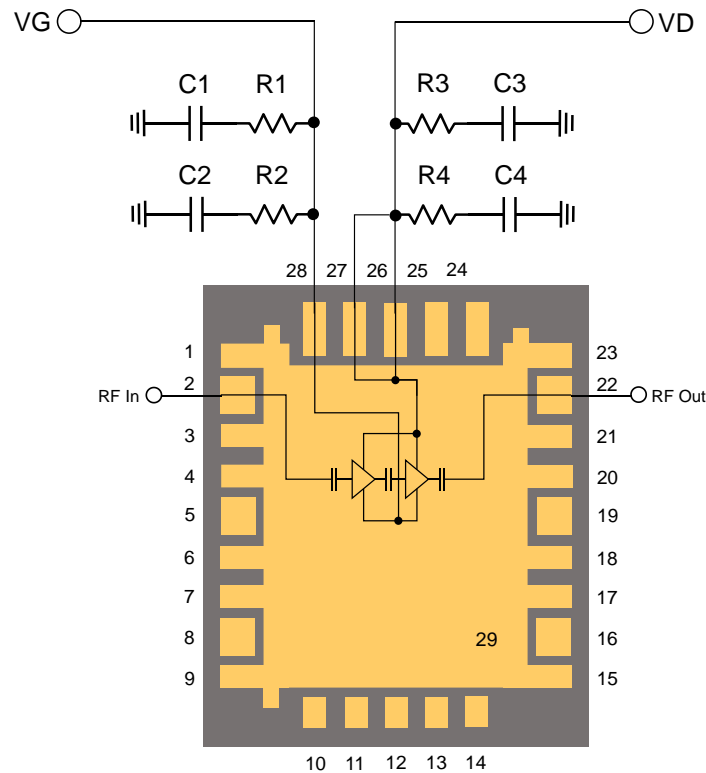

Bias Up Procedure

1. Set I_D limit to 1.3 A, I_G limit to 10 mA
2. Apply -5 V to V_G
3. Apply $+28\text{ V}$ to V_D ; ensure I_{DQ} is approx. 0 mA
4. Adjust V_G until $I_{DQ} = 650\text{ mA}$
5. Turn on RF supply

Bias Down Procedure

1. Turn off RF supply
2. Reduce V_G to -5 V ; ensure I_{DQ} is approx. 0 mA
3. Set V_D to 0 V
4. Turn off V_D supply
5. Turn off V_G supply

Pin Description

Pin No.	Symbol	Description
1, 3, 4, 6, 7, 9, 15, 17, 18, 20, 21, 23	GND	Must be grounded on the PCB
2	RF IN	RF Input; matched to $50\ \Omega$, DC blocked
5, 8, 10-14, 16, 19, 24, 25	NC	No internal connection. Should be connected to PCB ground
22	RF OUT	RF Output; matched to $50\ \Omega$, DC blocked
26, 27	VD	Drain voltage, bias network is required; see Application Circuit as an example
28	VG	Gate voltage, bias network is required; see Application Circuit as an example
29	GND	Center pad ground connection

Evaluation Board (EVB) Layout Assembly

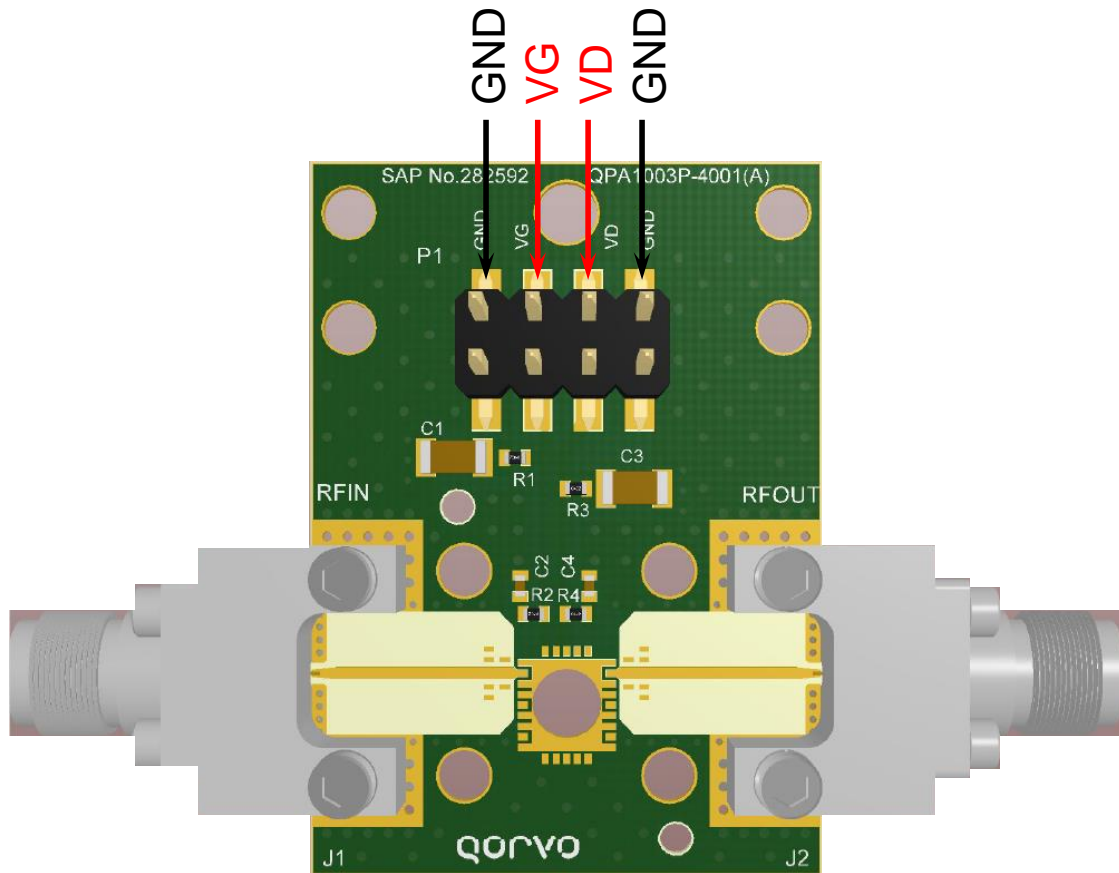

Notes:

1. PCB is 4 metal layers, each 0.5 oz. copper.
 Core 1 – Taconics TSM-DS, 0.010 in. thick
 Core 2 – Epoxy coated glass fabric
 Core 3 – 370HR, 0.006 in. thick
2. Center of PCB mounting area is a copper coin for thermal management and RF grounding.

Bill of Materials

Reference Des.	Value	Description	Manuf.	Part Number
C1, C3	1 uF	CAP, 1UF, 10%, 50V, X7R, 1206	Various	–
C2, C4	1000 pF	CAP, 1000pF, 10%, 50V, X7R, 0402	Various	–
R1, R2, R3, R4	5.1 Ohm	RES, 5.1 OHM, 5%, 50V, 0402	Various	–
J1, J2	2.92 mm	RF CONN, F, 2.92 mm	Southwest Microwave	1092-01A-5

Mechanical Information

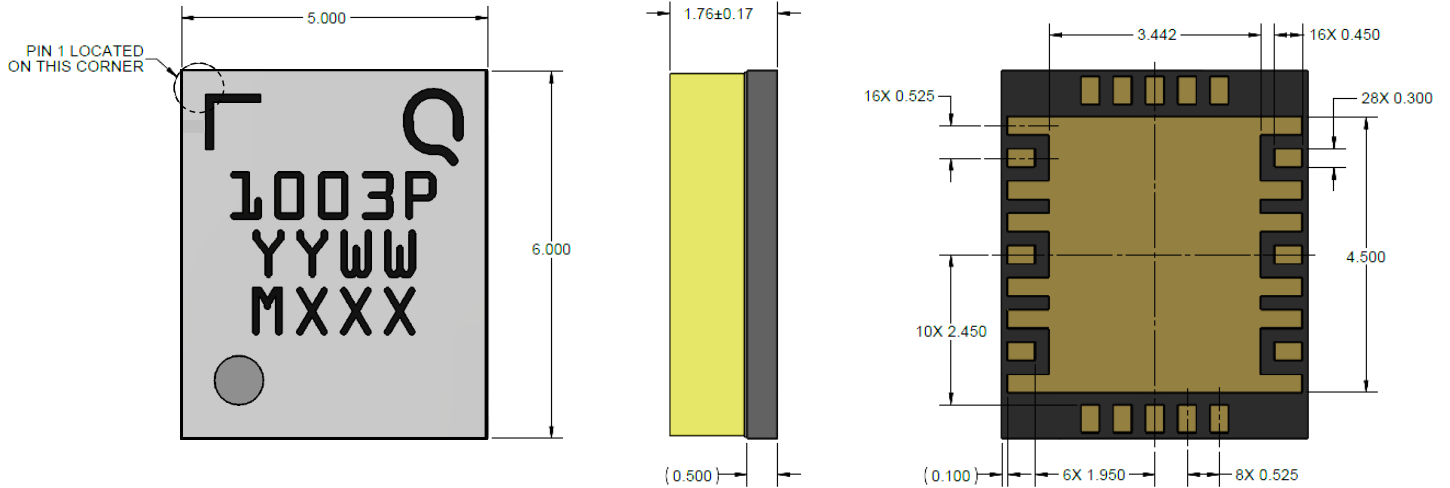

Units: Millimeter (mm)

Tolerances: unless specified

x.xx = ± 0.25

x.xxx = ± 0.100

Materials:

Base: EHS Laminate

Lid: Laminate

All metalized features are gold plated

Part is epoxy sealed

Marking:

1003P: Part number

YY: Part Assembly year

WW: Part Assembly week

MXXX: Batch ID

Assembly Notes

Compatible with lead-free soldering processes with 260°C peak reflow temperature.

This package is air-cavity and non-hermetic, and therefore cannot be subjected to aqueous washing. The use of no-clean solder to avoid washing after soldering is highly recommended.

Contact plating: Ni-Au

If rework is required, do not expose the package lid to temperatures > 280 °C

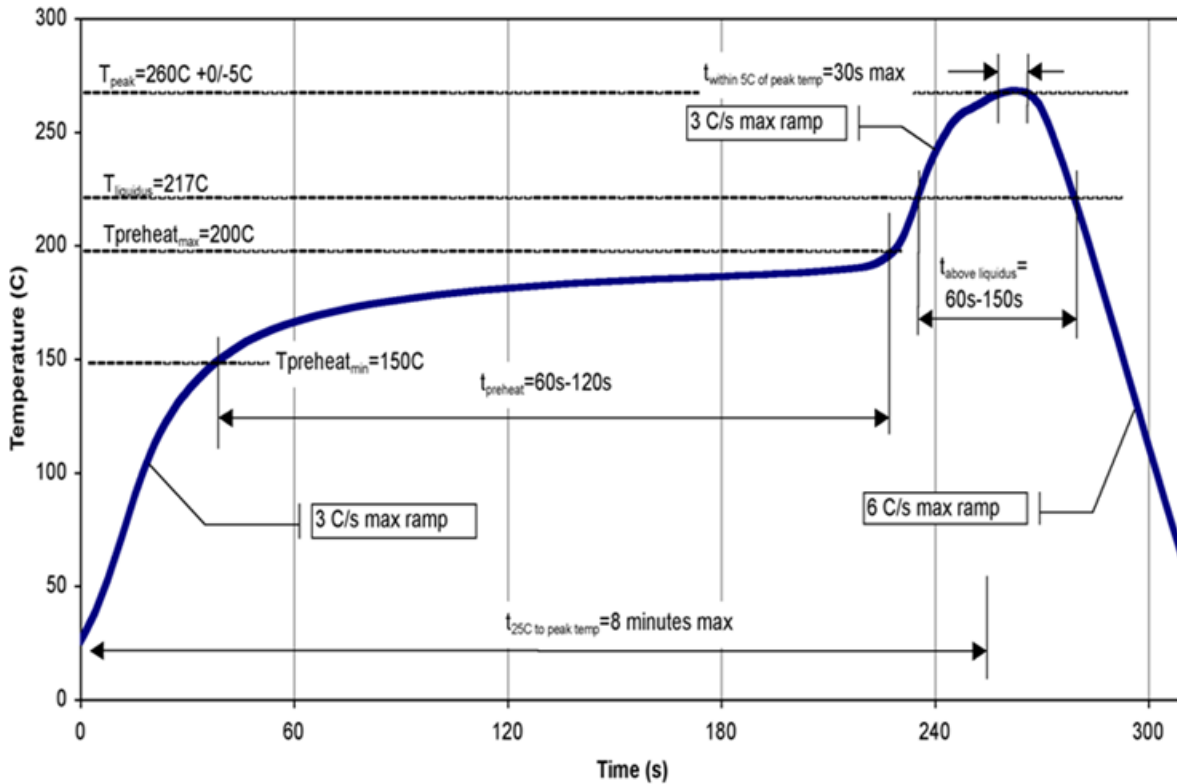

Recommended Soldering Temperature Profile

Handling Precautions

Parameter	Rating	Standard
ESD – Human Body Model (HBM)	0B	ESDA / JEDEC JS-001-2012
MSL – Moisture Sensitivity Level	MSL3	IPC/JEDEC J-STD-020



Caution!
 ESD-Sensitive Device

RoHS Compliance

This product is compliant with the 2011/65/EU RoHS directive (Restrictions on the Use of Certain Hazardous Substances in Electrical and Electronic Equipment), as amended by Directive 2015/863/EU. This product also has the following attributes:

- Lead Free
- Antimony Free
- TBBP-A (C₁₅H₁₂Br₄O₂) Free
- PFOS Free

Contact Information

For the latest specifications, additional product information, worldwide sales and distribution locations:

Web: www.qorvo.com

Tel: 1-844-890-8163

Email: customer.support@qorvo.com

Important Notice

The information contained herein is believed to be reliable; however, Qorvo makes no warranties regarding the information contained herein and assumes no responsibility or liability whatsoever for the use of the information contained herein. All information contained herein is subject to change without notice. Customers should obtain and verify the latest relevant information before placing orders for Qorvo products. The information contained herein or any use of such information does not grant, explicitly or implicitly, to any party any patent rights, licenses, or any other intellectual property rights, whether with regard to such information itself or anything described by such information. **THIS INFORMATION DOES NOT CONSTITUTE A WARRANTY WITH RESPECT TO THE PRODUCTS DESCRIBED HEREIN, AND QORVO HEREBY DISCLAIMS ANY AND ALL WARRANTIES WITH RESPECT TO SUCH PRODUCTS WHETHER EXPRESS OR IMPLIED BY LAW, COURSE OF DEALING, COURSE OF PERFORMANCE, USAGE OF TRADE OR OTHERWISE, INCLUDING THE IMPLIED WARRANTIES OF MERCHANTABILITY AND FITNESS FOR A PARTICULAR PURPOSE.**

Without limiting the generality of the foregoing, Qorvo products are not warranted or authorized for use as critical components in medical, life-saving, or life-sustaining applications, or other applications where a failure would reasonably be expected to cause severe personal injury or death.

© 2020 Qorvo US, Inc. All rights reserved. This document is subject to copyright laws in various jurisdictions worldwide and may not be reproduced or distributed, in whole or in part, without the express written consent of Qorvo US, Inc.

Mouser Electronics

Authorized Distributor

Click to View Pricing, Inventory, Delivery & Lifecycle Information:

[Qorvo:](#)

[QPA1003P](#) [QPA1003P EVAL BOARD](#)