

Product Overview

Qorvo's TGA2962 is a wideband power amplifier fabricated on Qorvo's QGaN15 GaN on SiC process. The TGA2962 operates from 2 to 20 GHz, providing 10 W of saturated power with 13 dB large signal gain and 22 % power-added efficiency at 22 V drain bias. RF ports are matched to 50 Ω, including integrated DC blocking capacitors and a RF choke.

This combination of wideband power, gain and efficiency provides system designers the flexibility to improve system performance while reducing size and cost. TGA2962 is ideally suited for wideband communications systems, electronic warfare, test instrumentation, and radar applications, across both military and commercial markets.

TGA2962 is 100% DC and RF tested on-wafer to ensure compliance to electrical specifications.

Lead free and RoHS compliant.

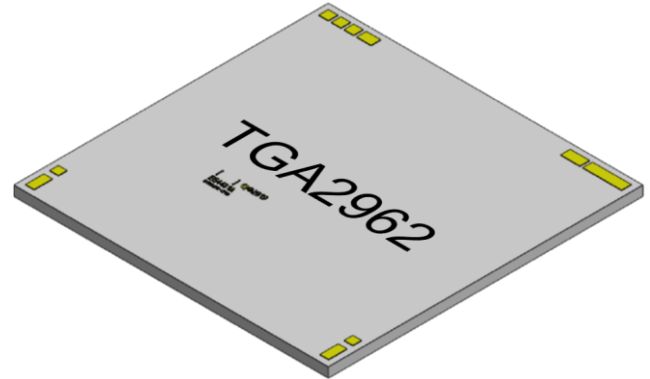

Key Features

- Frequency Range: 2 – 20 GHz
- P_{SAT} ($P_{IN}=27$ dBm): > 40 dBm
- PAE ($P_{IN}=27$ dBm): > 22 %
- Power Gain ($P_{IN}=27$ dBm): 13 dB
- Small Signal Gain: 20 dB
- Bias: $V_D = 22$ V, $I_{DQ} = 1680$ mA
- Die Dimensions: 3.24 x 3.24 x 0.10 mm

Performance is typical across frequency. Please reference electrical specification table and data plots for more details.

Functional Block Diagram

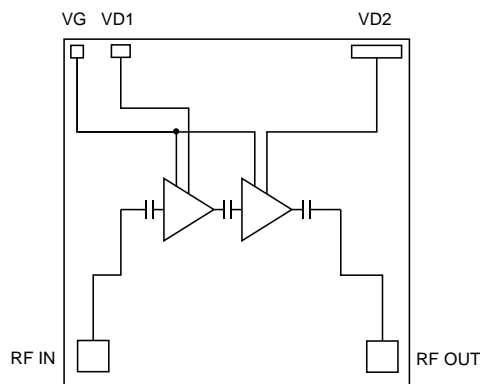

Top View

Applications

- Communication Systems
- Electronic Warfare
- Radar
- Test Equipment

Ordering Information

Part No.	Description
TGA2962	2 – 20 GHz 10 Watt GaN Amplifier (10 Pcs.)
TGA2962EVB	Evaluation Board for TGA2962

Absolute Maximum Ratings

Parameter	Value / Range
Drain Voltage (V_D)	29.5 V
Gate Voltage Range (V_G)	-5 V to 0 V
Drain Current (I_D)	2848 mA
Gate Current (I_G)	10 mA
Power Dissipation (P_{DISS}), 85 °C	45 W
Input Power (P_{IN}), 50 Ω , $V_D=22$ V, $I_{DQ}=1.68$ A, 85 °C	33 dBm
Input Power (P_{IN}), 3:1 VSWR, $V_D=22$ V, $I_{DQ}=1.68$ A, 85 °C	32 dBm
Soldering Temperature (30 s max.)	320 °C
Storage Temperature	-55 to +125 °C

Operation of this device outside the parameter ranges given above may cause permanent damage. These are stress ratings only, and functional operation of the device at these conditions is not implied.

Recommended Operating Conditions

Parameter	Value / Range
Drain Voltage (V_D)	22 V
Drain Current (I_{DQ})	1680 mA
Operating Temperature	-40 to +85 °C

Electrical specifications are measured at specified test conditions. Specifications are not guaranteed over all recommended operating conditions.

Electrical Specifications

Parameter		Min	Typ	Max	Units
Operational Frequency		2		20	GHz
Output Power ($P_{IN} = 27$ dBm)	2 GHz		41.3		dBm
	6 GHz		42.0		dBm
	10 GHz		41.3		dBm
	15 GHz		40.4		dBm
	20 GHz		40.3		dBm
Power Added Efficiency ($P_{IN} = 27$ dBm)	2 GHz		38.0		%
	6 GHz		30.4		%
	10 GHz		26.1		%
	15 GHz		22.4		%
	20 GHz		22.3		%
Small Signal Gain	2 GHz		19.6		dB
	6 GHz		20.5		dB
	10 GHz		20.0		dB
	15 GHz		20.5		dB
	20 GHz		19.7		dB
Input Return Loss	2 GHz		14		dB
	6 GHz		23		dB
	10 GHz		12		dB
	15 GHz		22		dB
	20 GHz		13		dB
Output Return Loss	2 GHz		17		dB
	6 GHz		22		dB
	10 GHz		14		dB
	15 GHz		11		dB
	20 GHz		10		dB
IMD3 ($P_{OUT}/Tone = 34$ dBm) (100 MHz tone spacing)	2 GHz		-21		dBc
	6 GHz		-22		dBc
	10 GHz		-20		dBc
	15 GHz		-20		dBc
	20 GHz		-18		dBc
Gate Leakage ($V_D = 10$ V, $V_G = -3.7$ V)		-8.4			mA
P_{OUT} Temp. Coeff. (85 °C to 25 °C, $P_{IN} = 27$ dBm))			-0.009		dB/°C
Sm. Sig. Gain Temp. Coefficient (85 °C to -40 °C)			-0.037		dB/°C

Test conditions, unless otherwise noted: T = 25 °C, VD = 22 V, IDQ = 1680 mA

Performance Plots – Small Signal

Test conditions, unless otherwise noted: $V_D = 22\text{ V}$, $I_{DQ} = 1680\text{ mA}$, $T = +25\text{ }^\circ\text{C}$

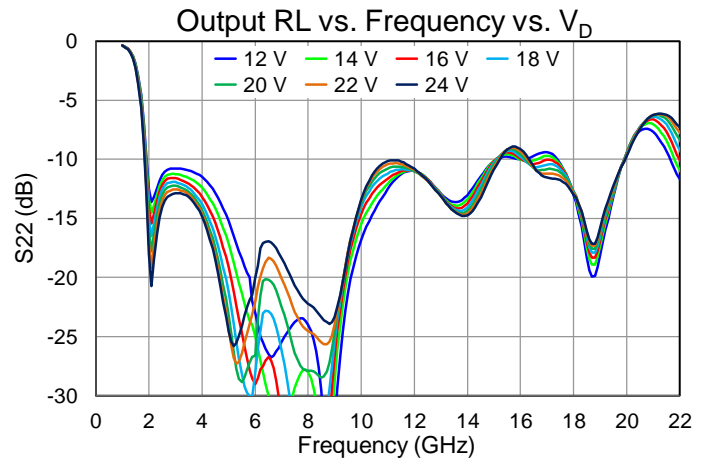
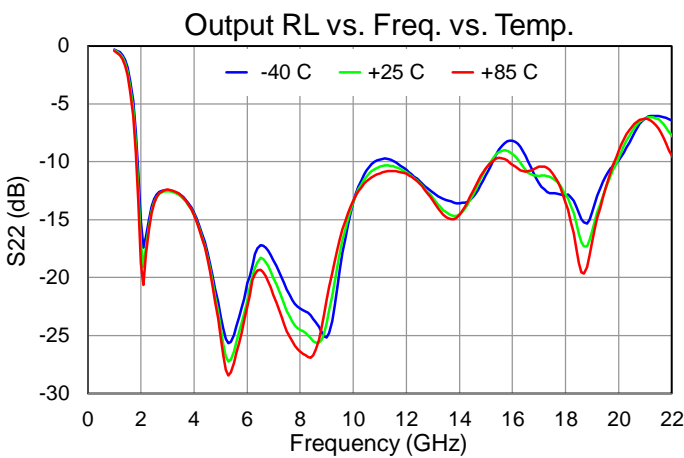
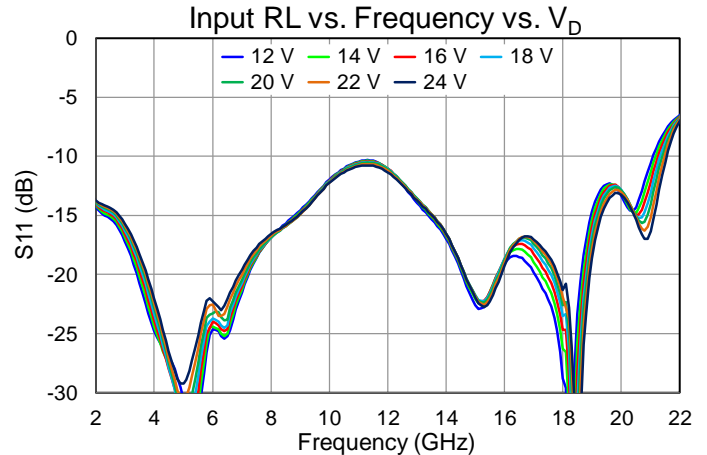
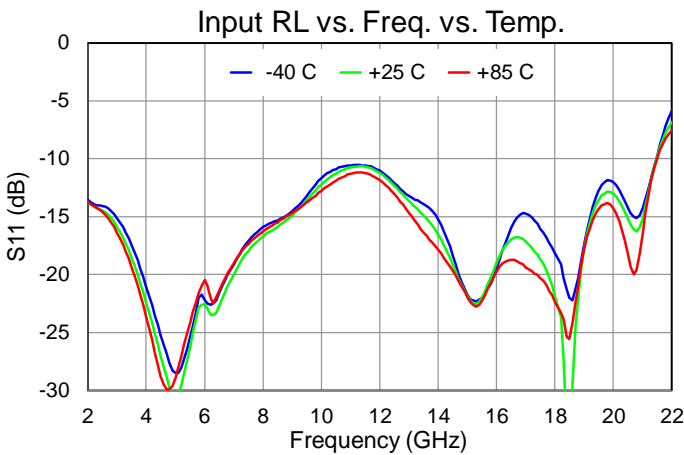
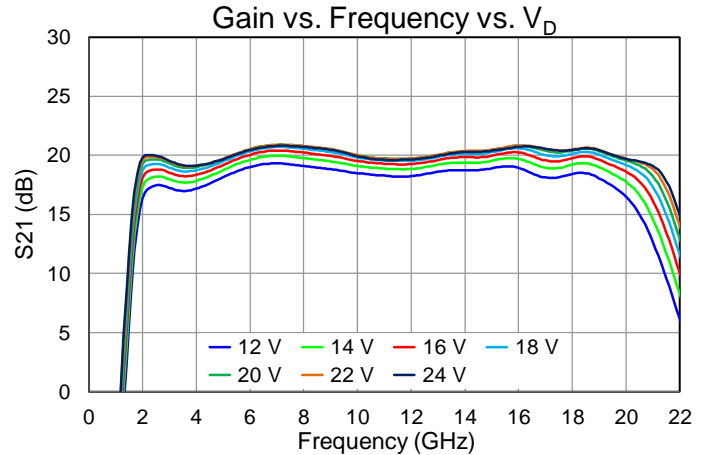
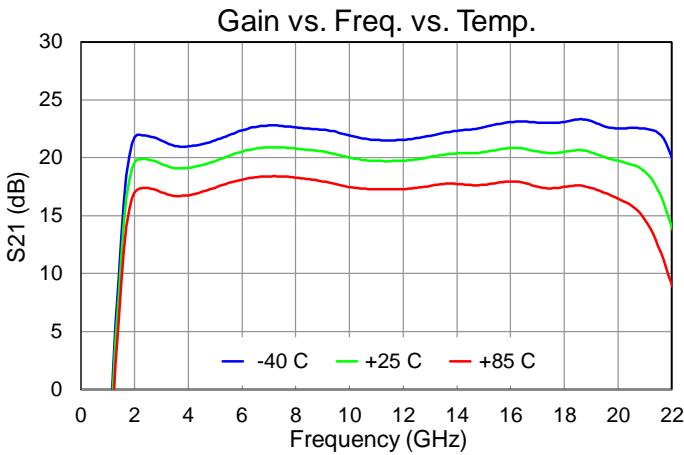

Performance Plots – Small Signal

Test conditions, unless otherwise noted: $V_D = 22\text{ V}$, $I_{DQ} = 1680\text{ mA}$, $T = +25\text{ }^\circ\text{C}$

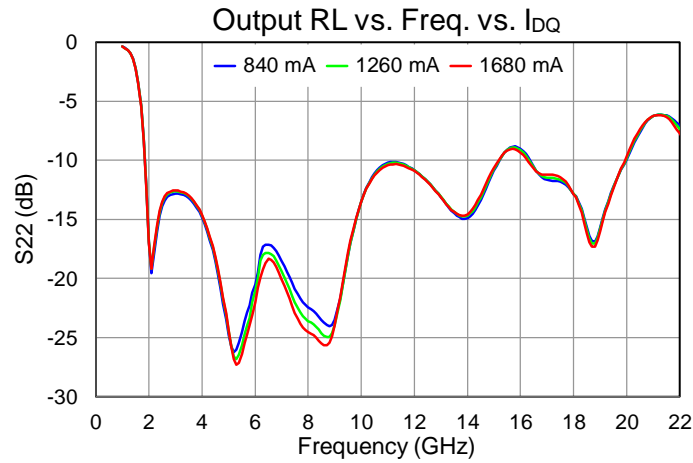
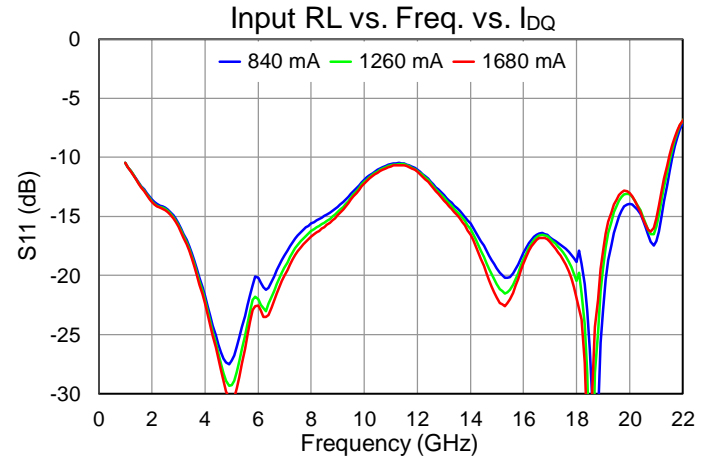
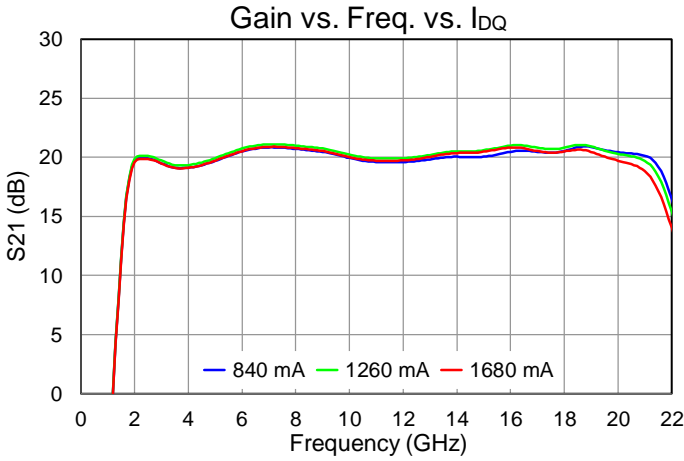

Performance Plots – Large Signal

Test conditions, unless otherwise noted: $V_D = 22\text{ V}$, $I_{DQ} = 1680\text{ mA}$, $T = +25\text{ }^\circ\text{C}$, $P_{in} = 27\text{ dBm}$

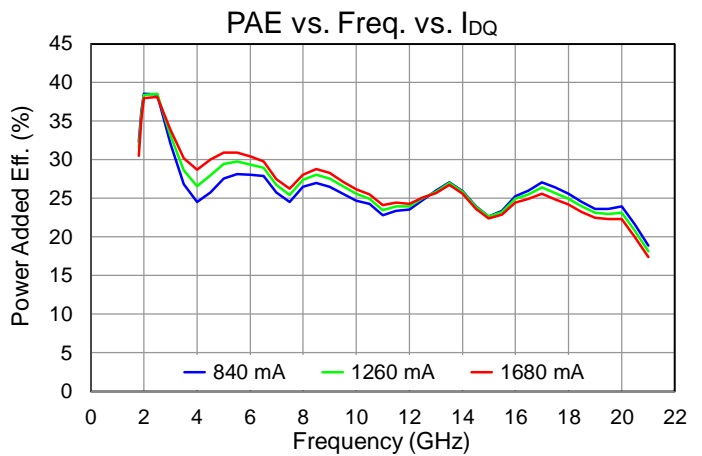
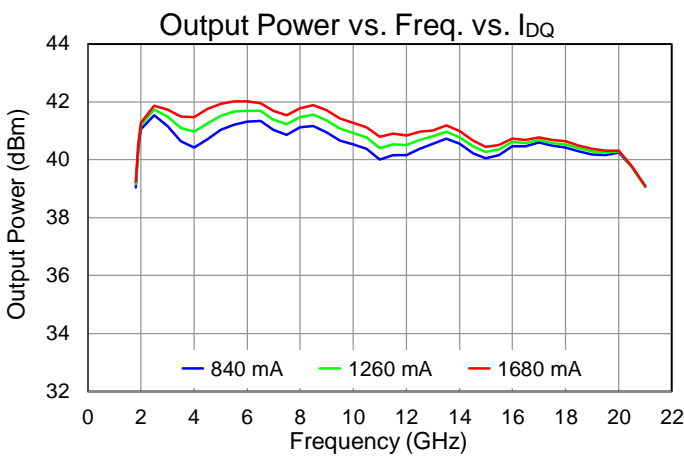
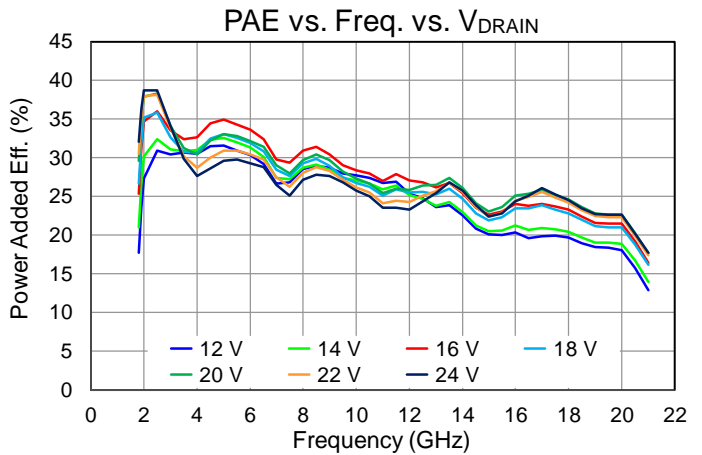
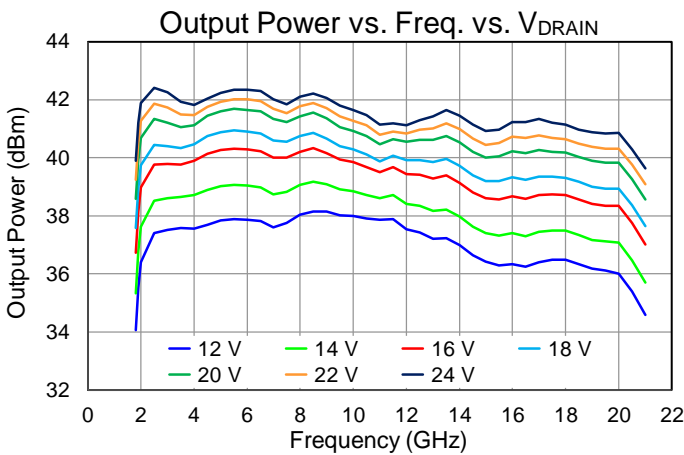
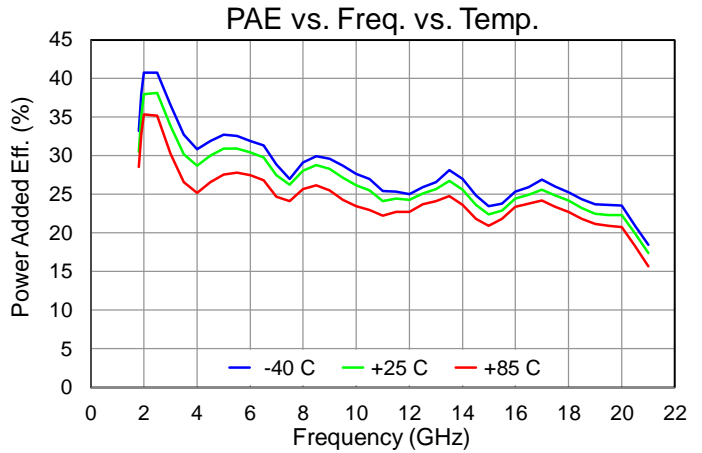
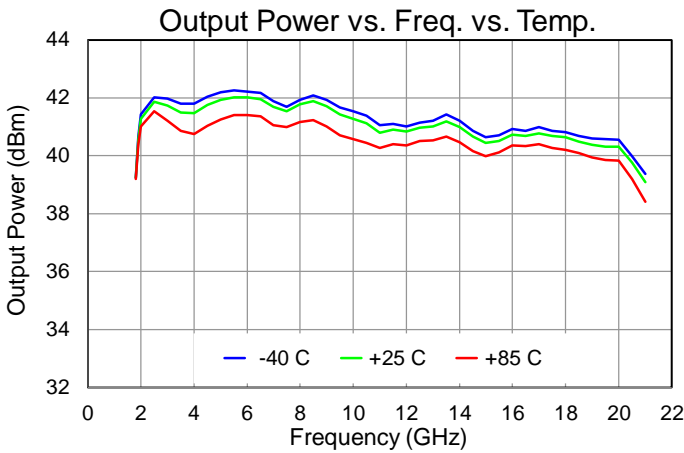

Performance Plots – Large Signal

Test conditions, unless otherwise noted: $V_D = 22\text{ V}$, $I_{DQ} = 1680\text{ mA}$, $T = +25\text{ }^\circ\text{C}$, $P_{in} = 27\text{ dBm}$

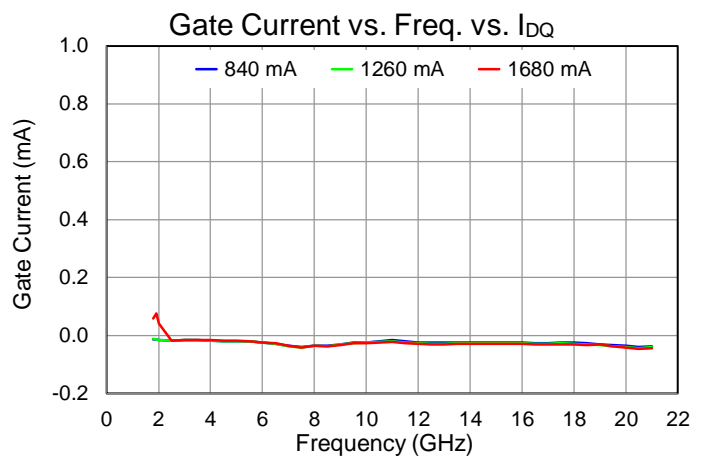
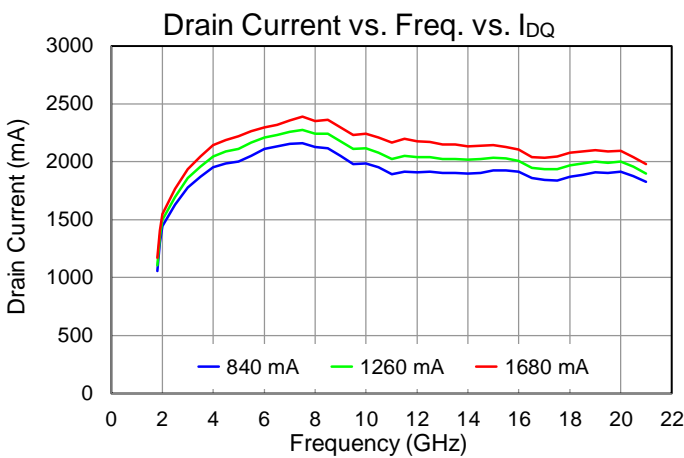
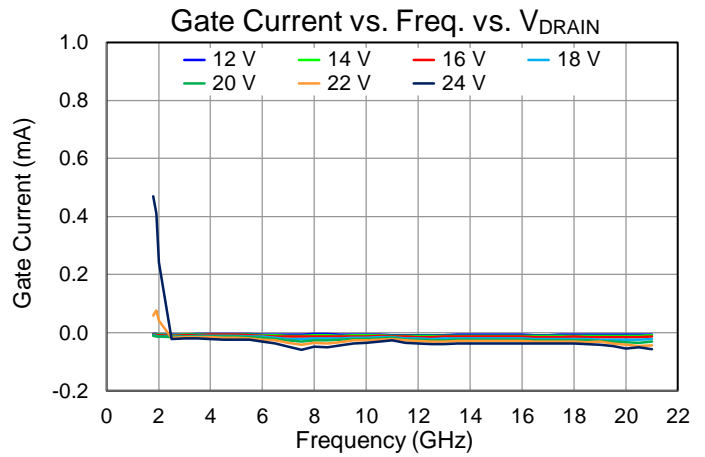
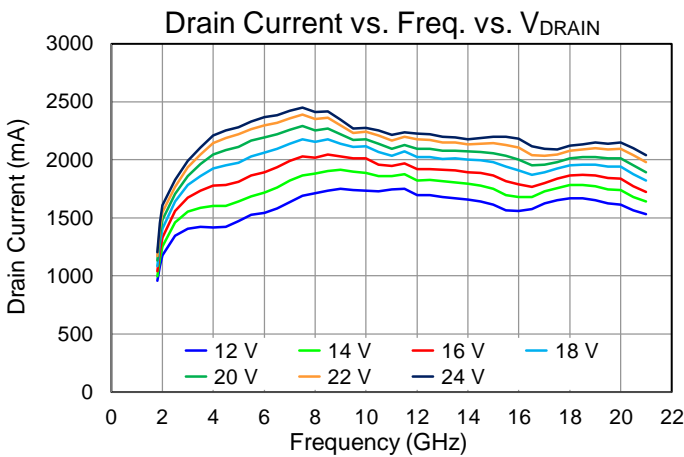
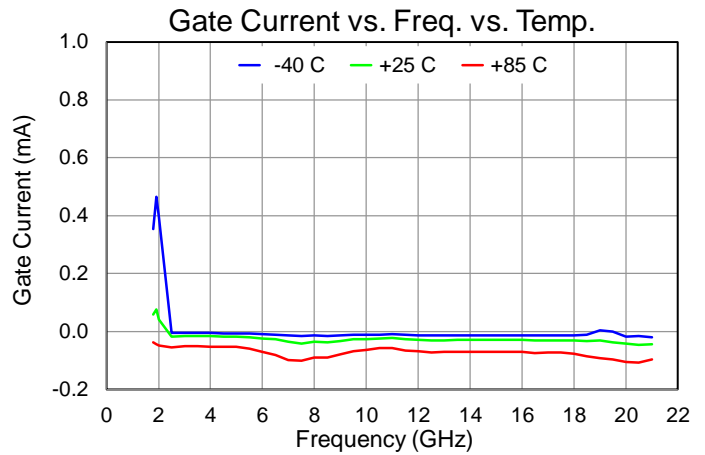
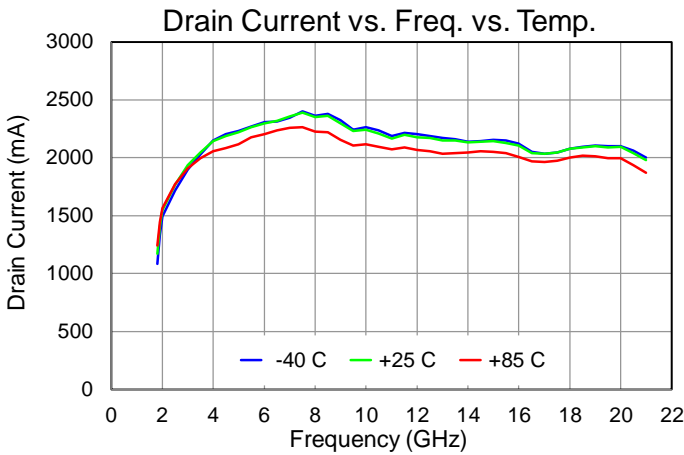

Performance Plots – Large Signal

Test conditions, unless otherwise noted: $V_D = 22\text{ V}$, $I_{DQ} = 1680\text{ mA}$, $T = +25\text{ }^\circ\text{C}$

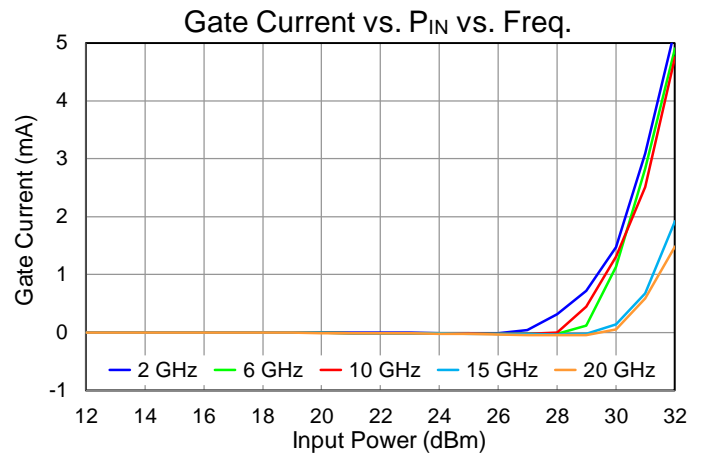
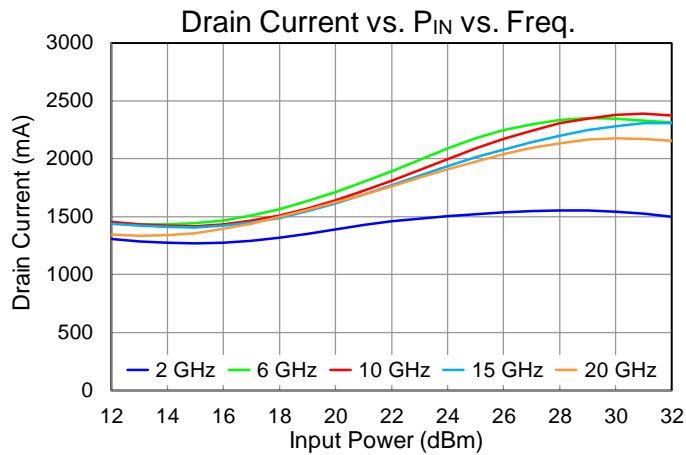
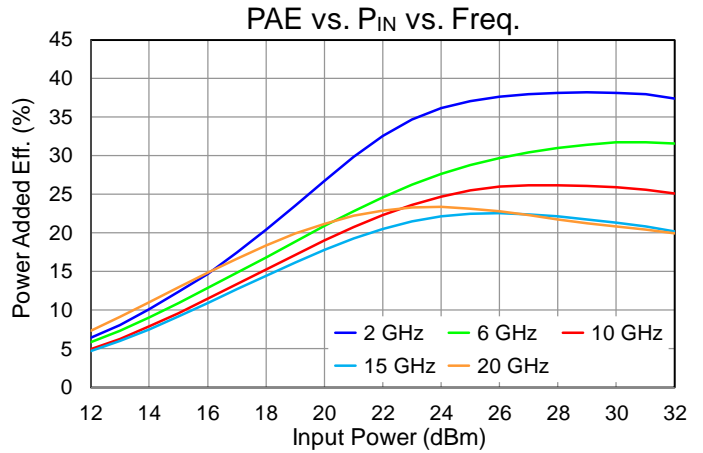
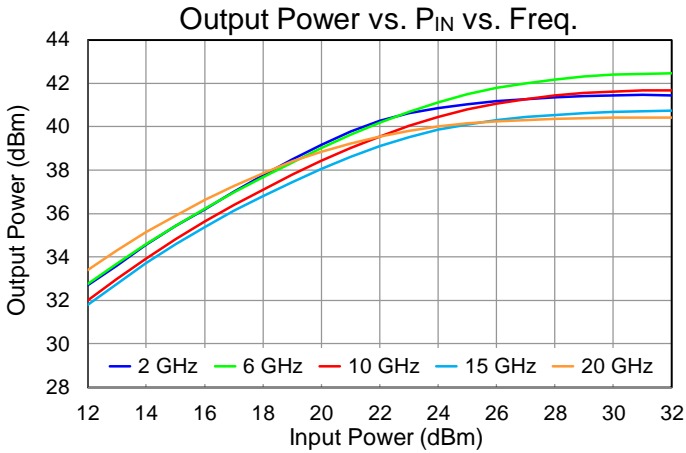

Performance Plots – Large Signal

Test conditions, unless otherwise noted: $V_D = 22\text{ V}$, $I_{DQ} = 1680\text{ mA}$, $T = +25\text{ }^\circ\text{C}$

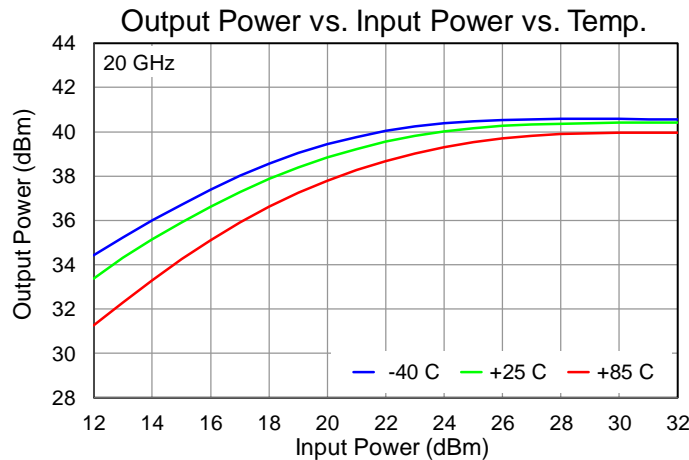
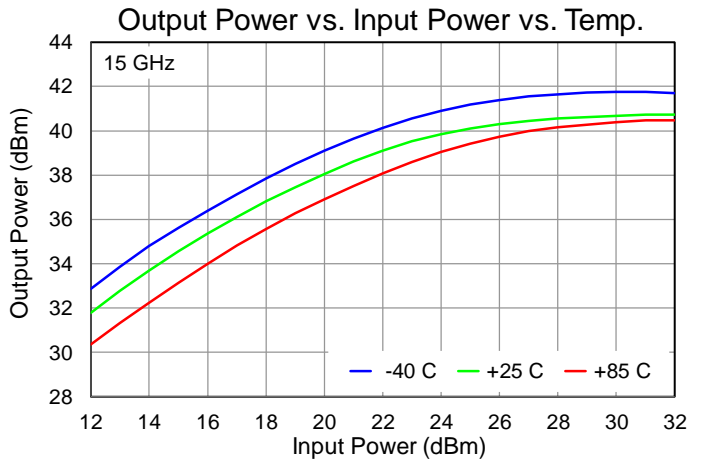
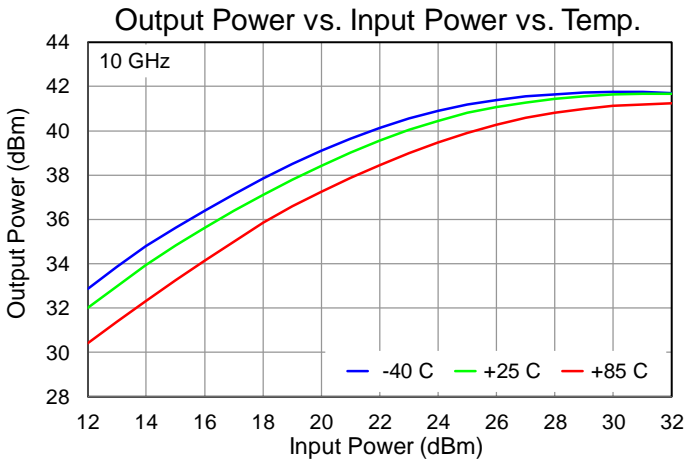
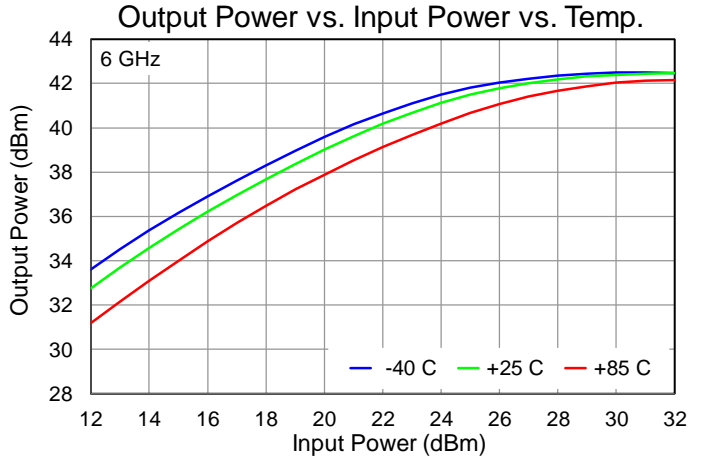
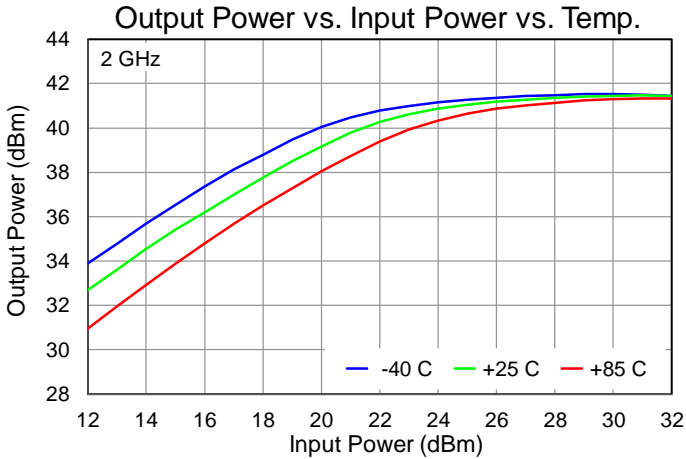

Performance Plots – Large Signal

Test conditions, unless otherwise noted: $V_D = 22\text{ V}$, $I_{DQ} = 1680\text{ mA}$, $T = +25\text{ }^\circ\text{C}$

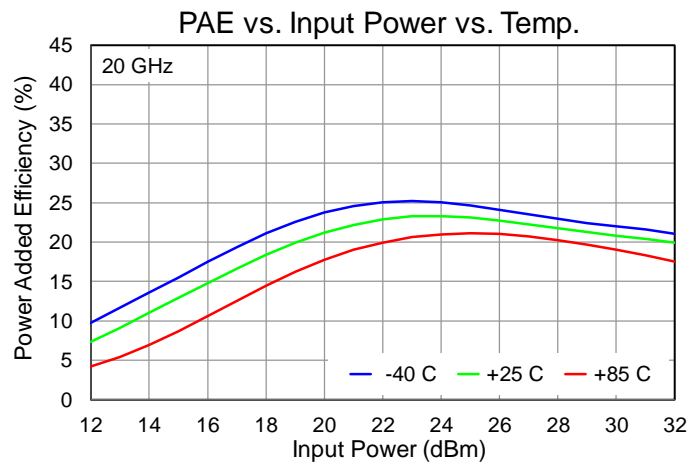
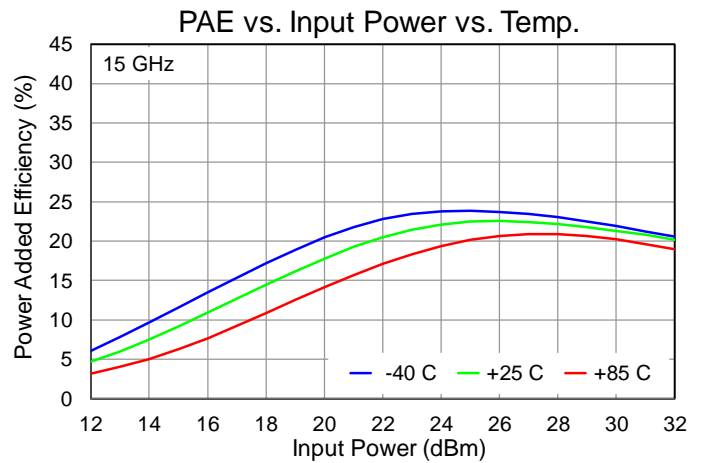
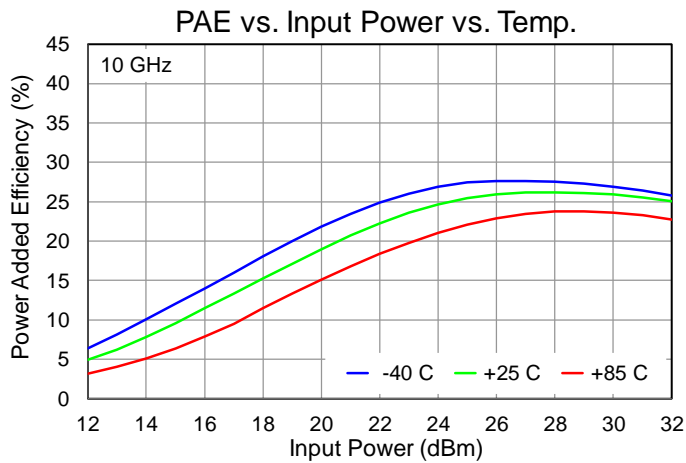
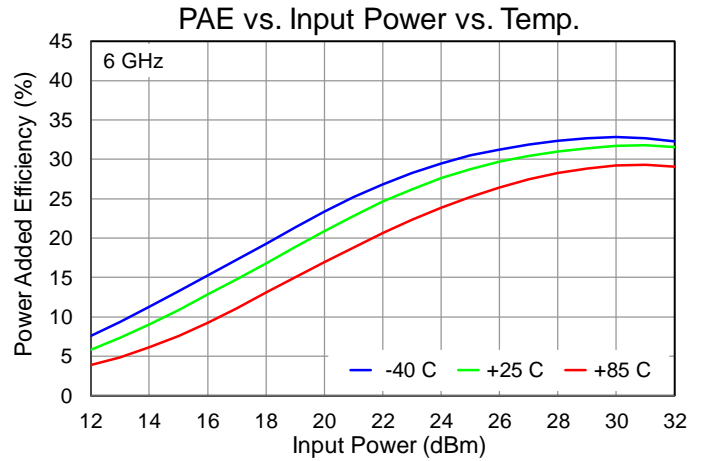
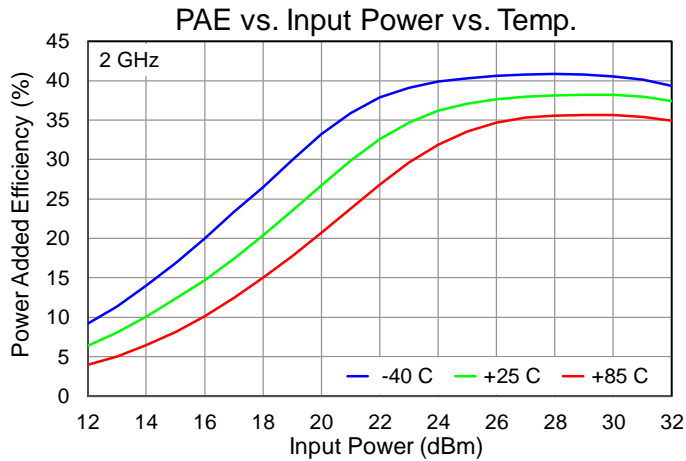

Performance Plots – Large Signal

Test conditions, unless otherwise noted: $V_D = 22\text{ V}$, $I_{DQ} = 1680\text{ mA}$, $T = +25\text{ }^\circ\text{C}$

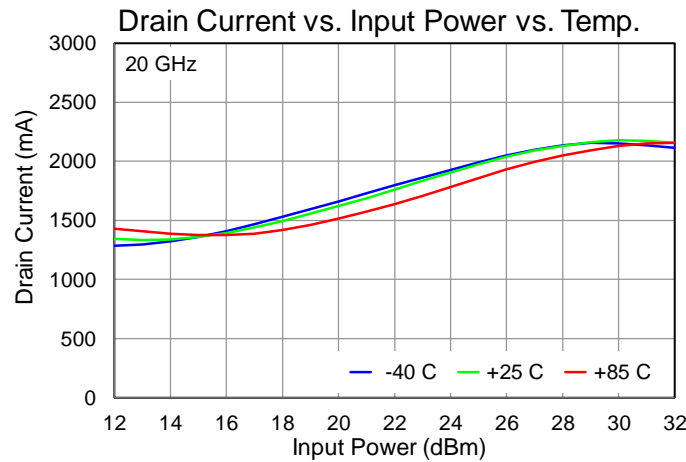
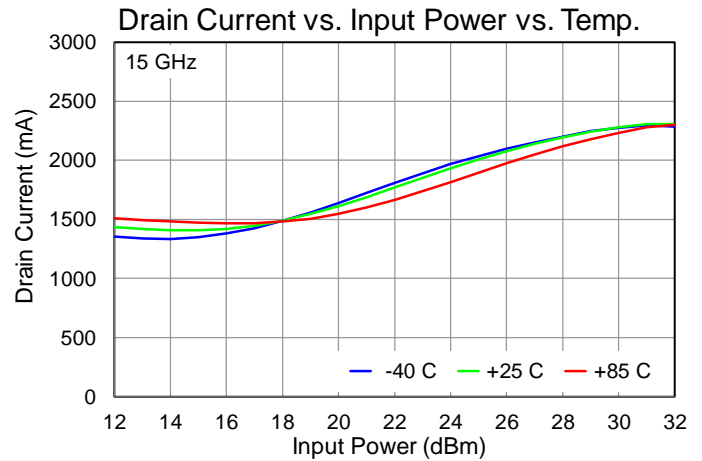
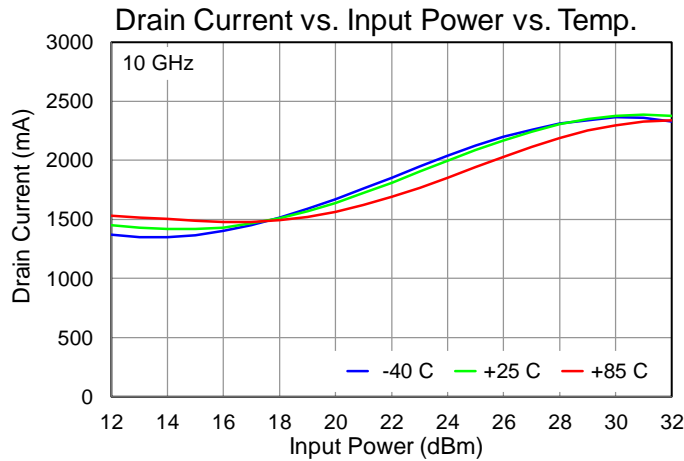
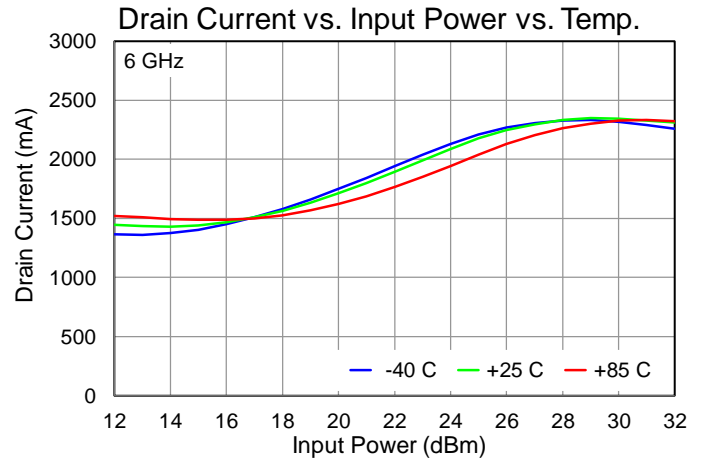
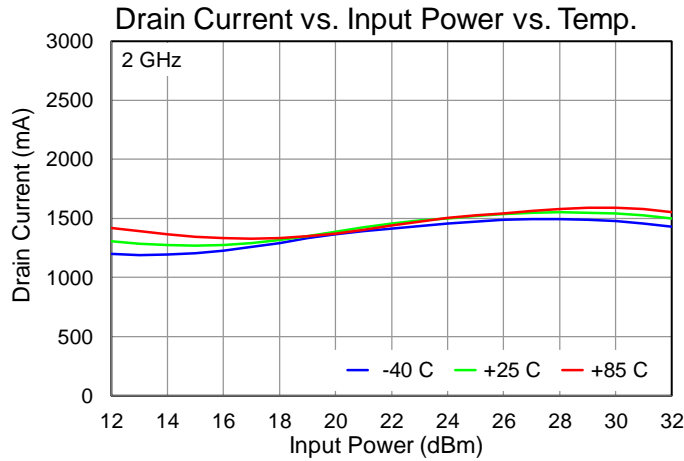

Performance Plots – Large Signal

Test conditions, unless otherwise noted: $V_D = 22\text{ V}$, $I_{DQ} = 1680\text{ mA}$, $T = +25\text{ }^\circ\text{C}$

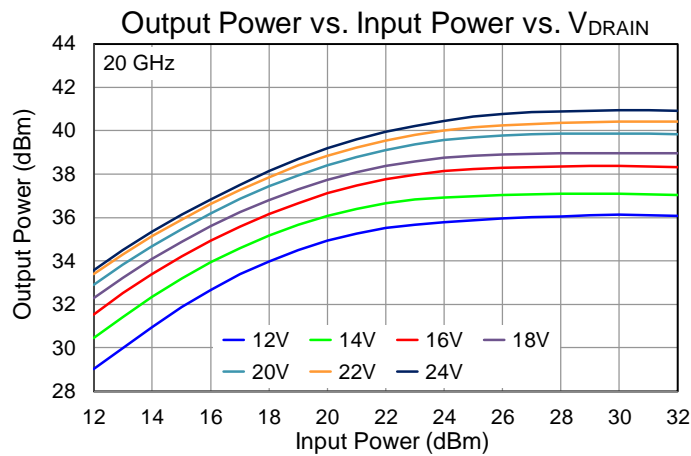
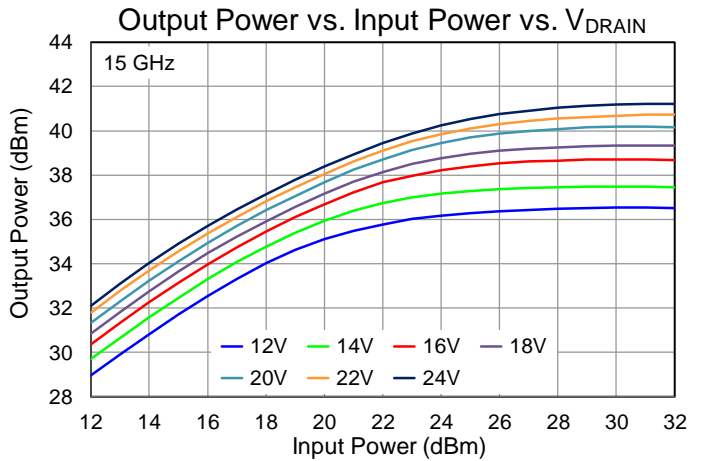
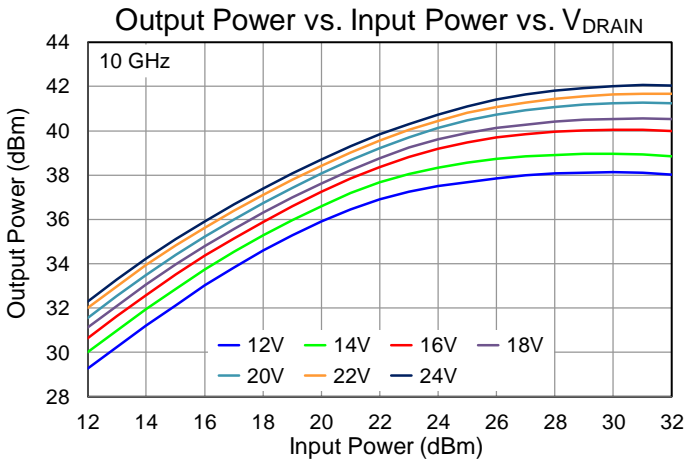
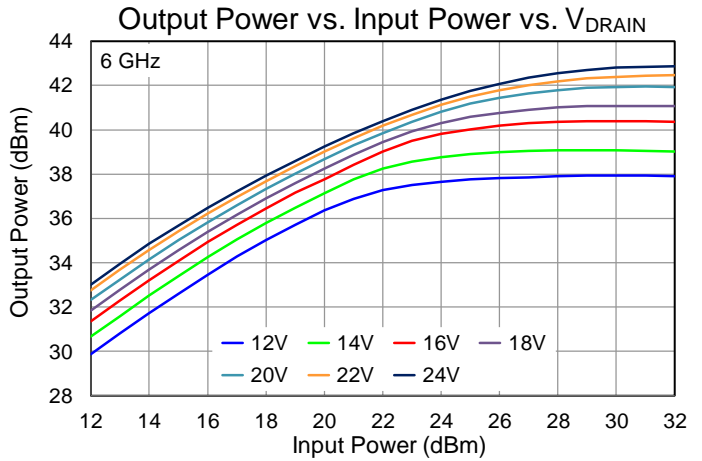
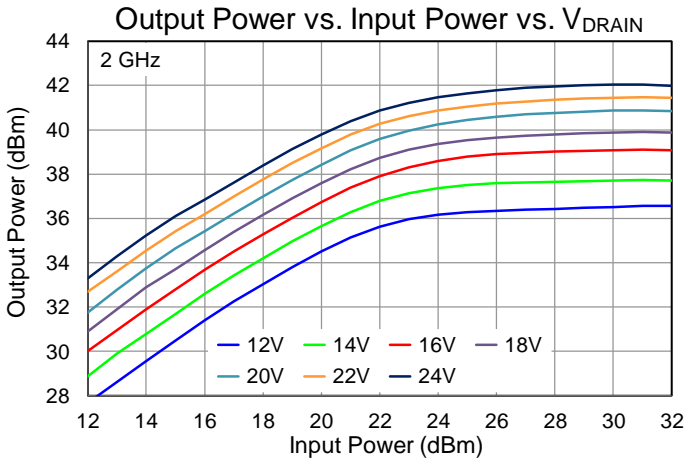

Performance Plots – Large Signal

Test conditions, unless otherwise noted: $V_D = 22\text{ V}$, $I_{DQ} = 1680\text{ mA}$, $T = +25\text{ }^\circ\text{C}$

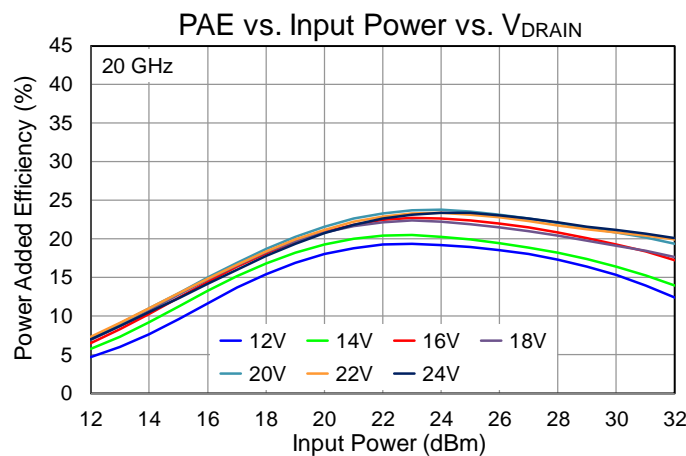
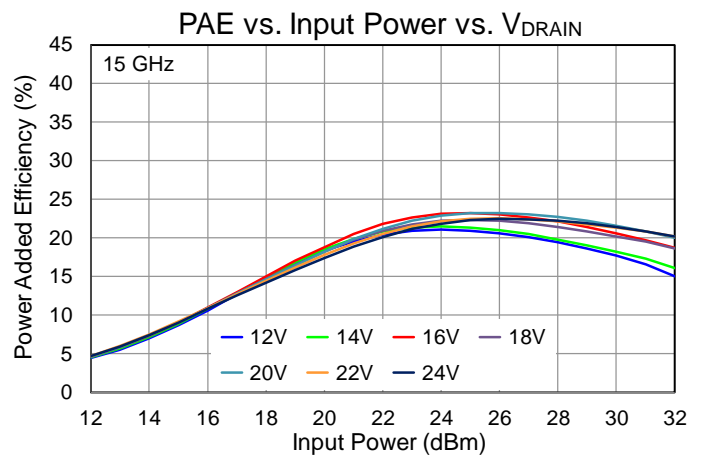
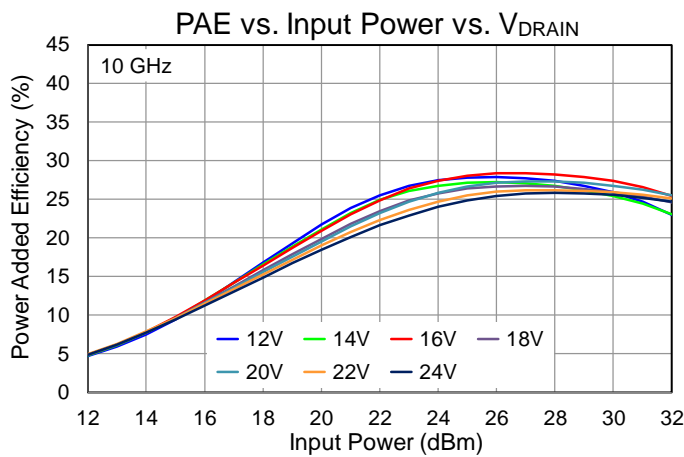
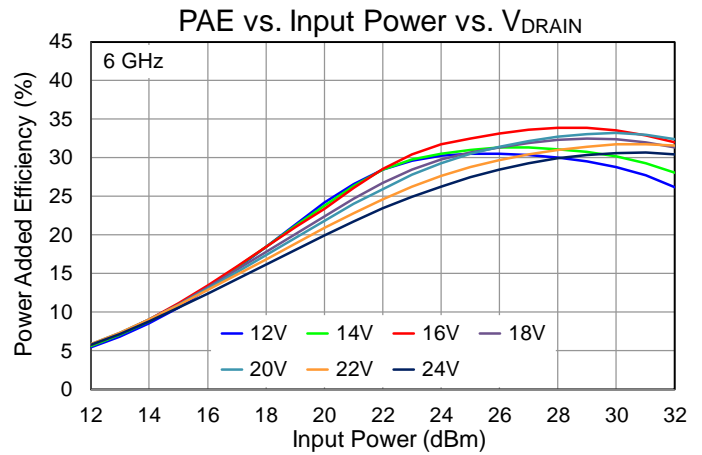
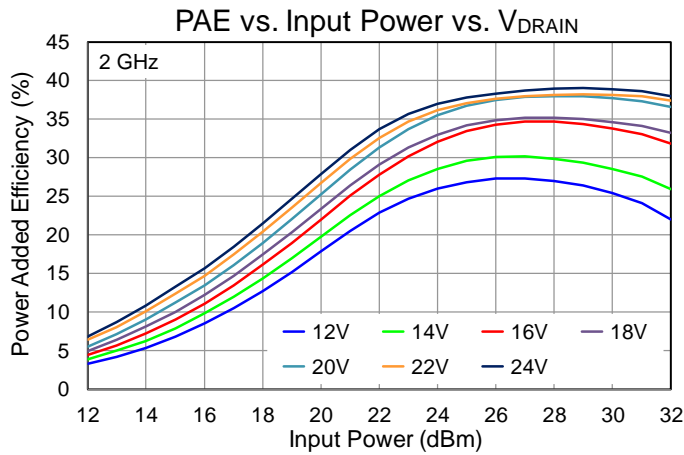

Performance Plots – Large Signal

Test conditions, unless otherwise noted: $V_D = 22\text{ V}$, $I_{DQ} = 1680\text{ mA}$, $T = +25\text{ }^\circ\text{C}$

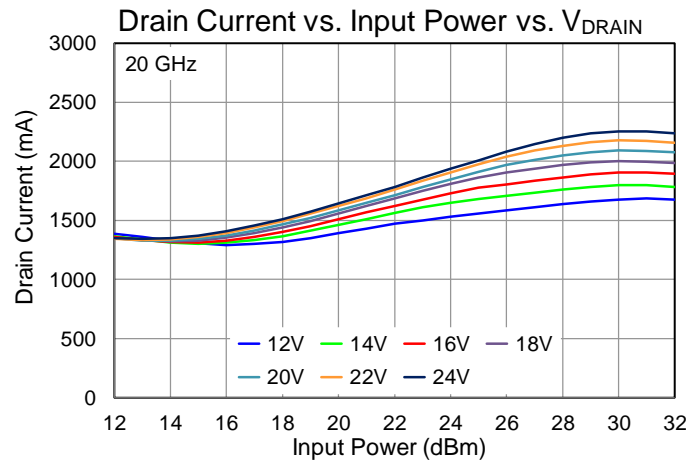
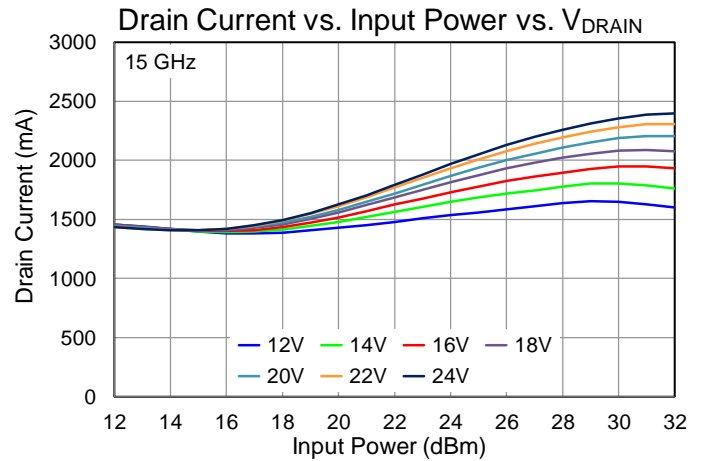
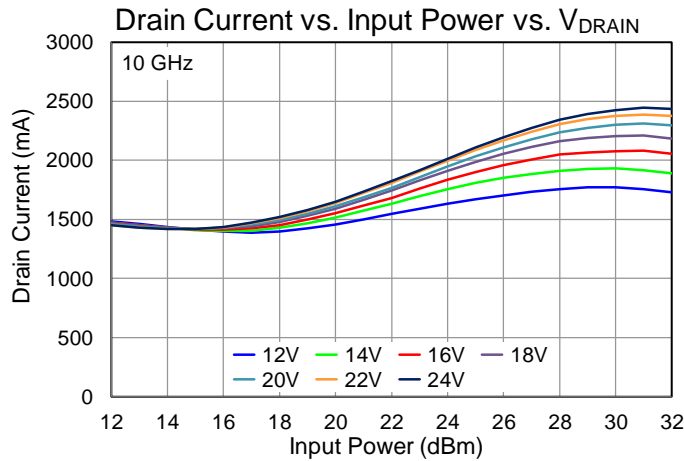
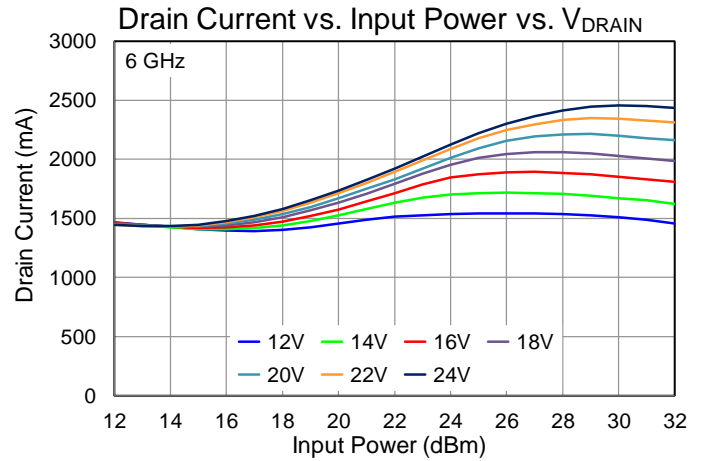
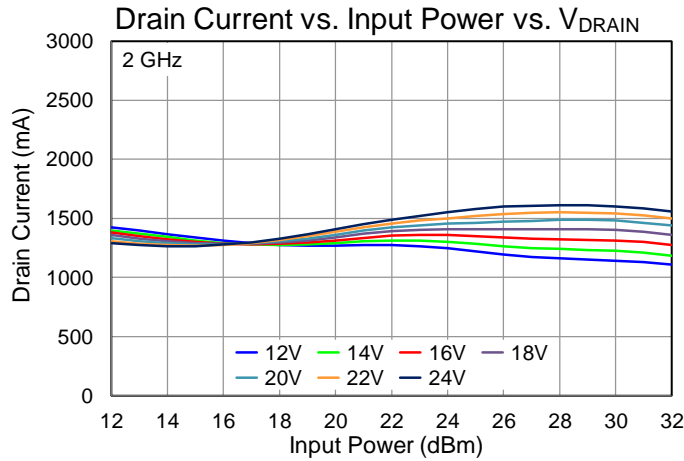

Performance Plots – Large Signal

Test conditions, unless otherwise noted: $V_D = 22\text{ V}$, $I_{DQ} = 1680\text{ mA}$, $T = +25\text{ }^\circ\text{C}$

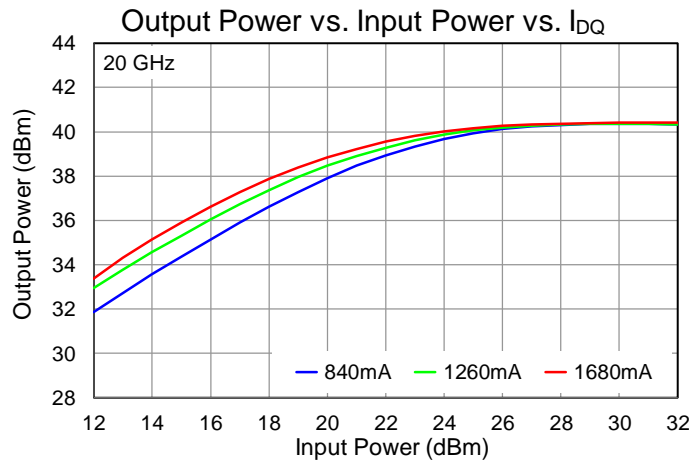
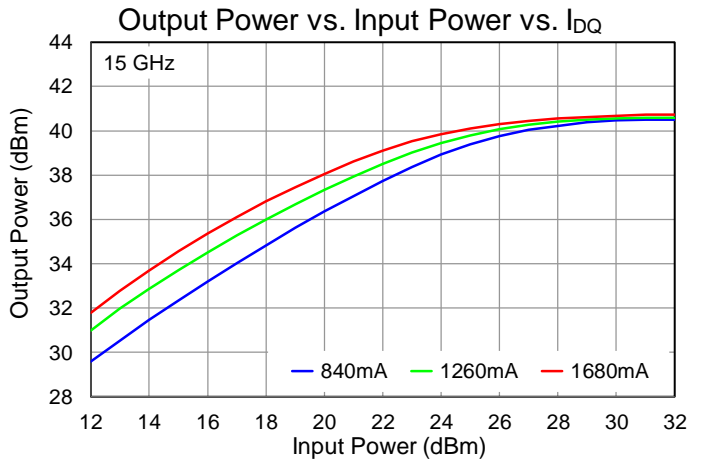
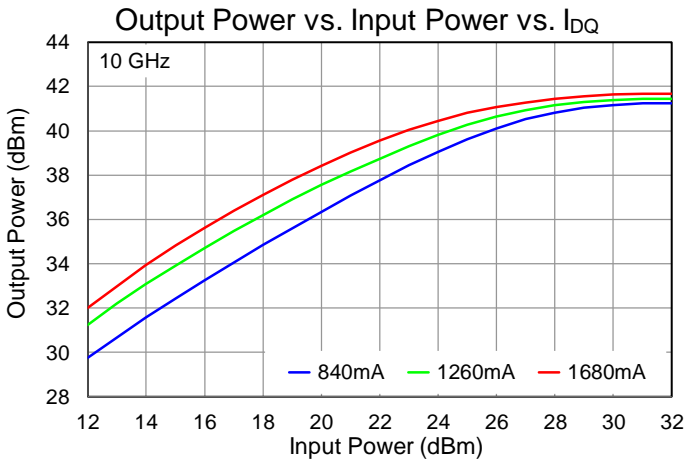
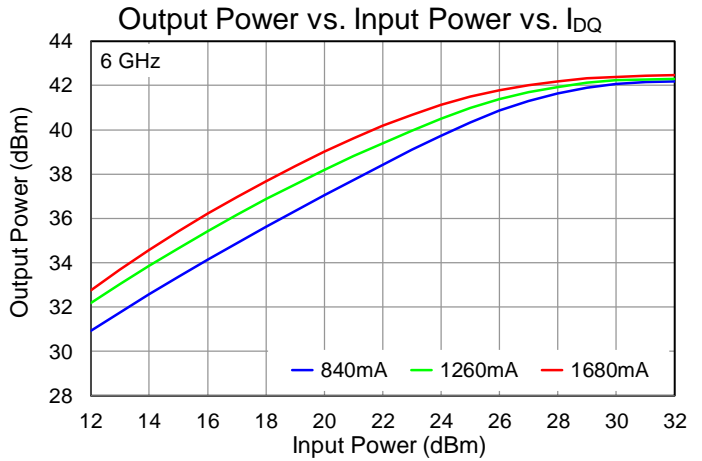
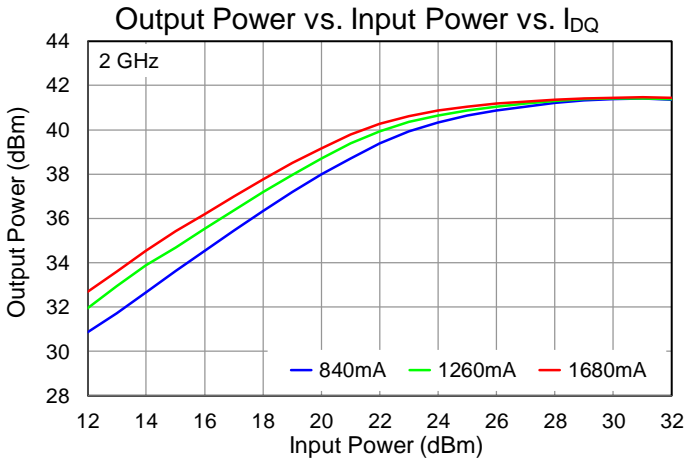

Performance Plots – Large Signal

Test conditions, unless otherwise noted: $V_D = 22\text{ V}$, $I_{DQ} = 1680\text{ mA}$, $T = +25\text{ }^\circ\text{C}$

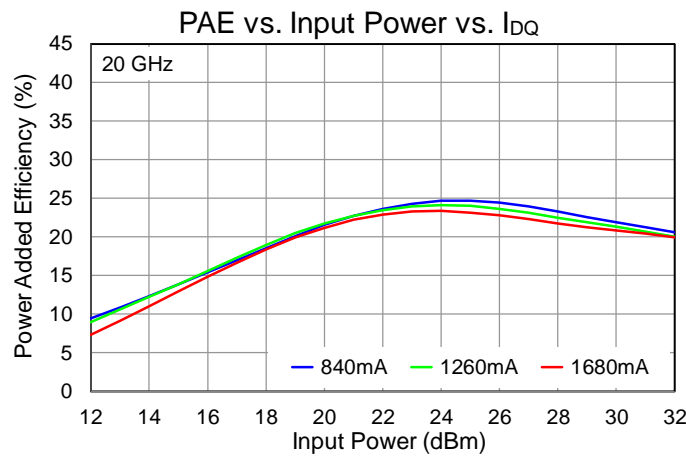
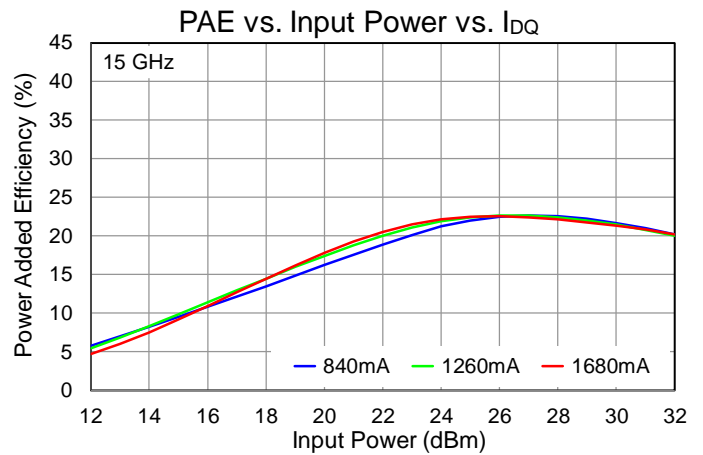
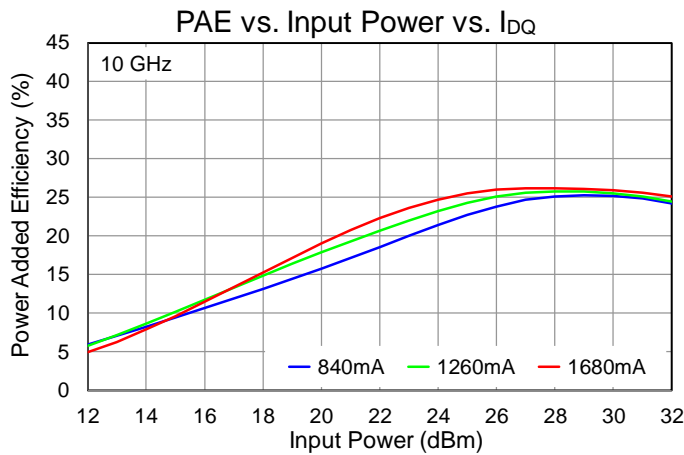
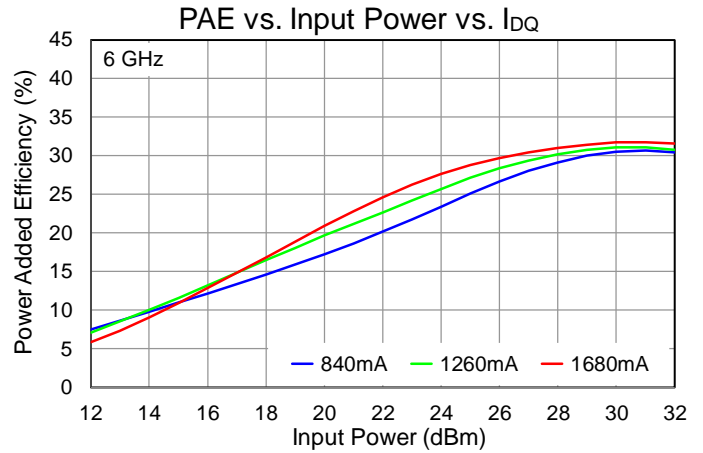
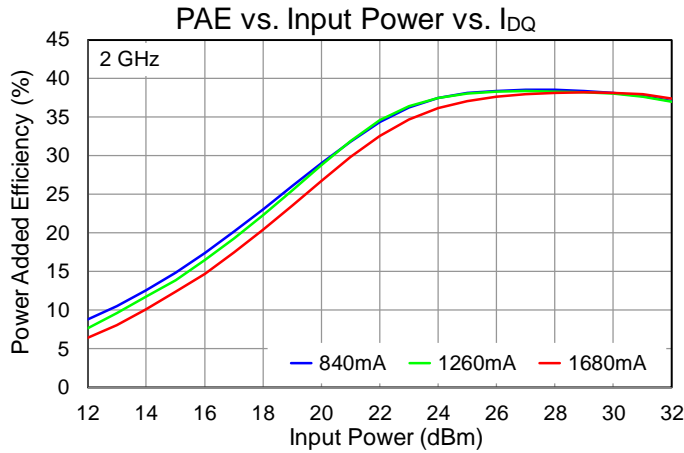

Performance Plots – Large Signal

Test conditions, unless otherwise noted: $V_D = 22\text{ V}$, $I_{DQ} = 1680\text{ mA}$, $T = +25\text{ }^\circ\text{C}$

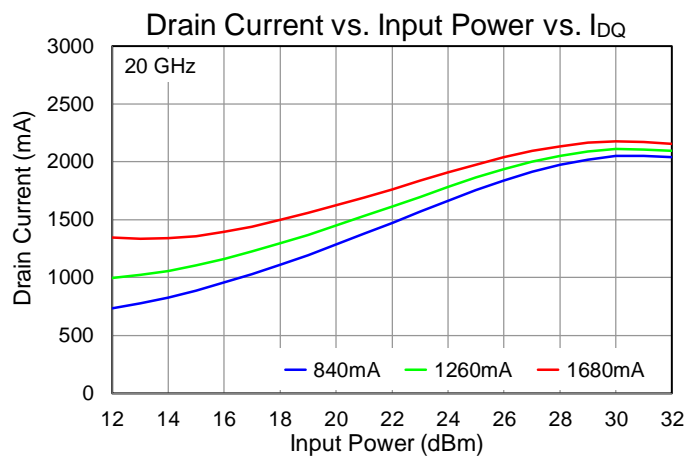
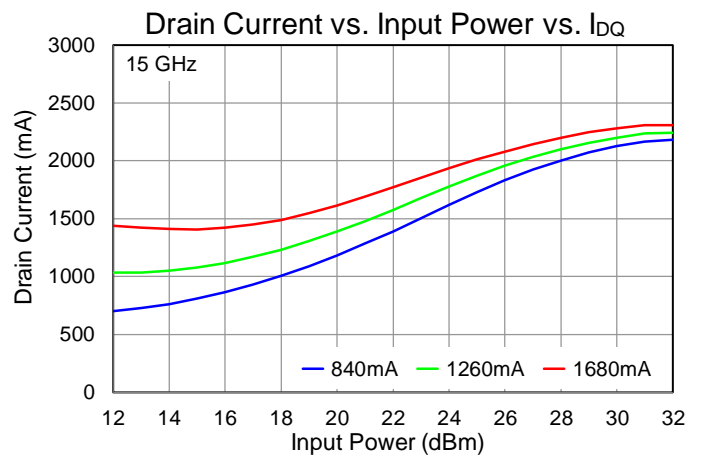
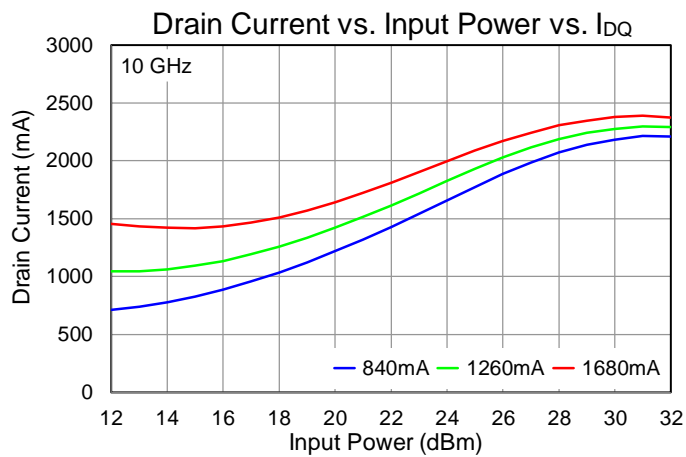
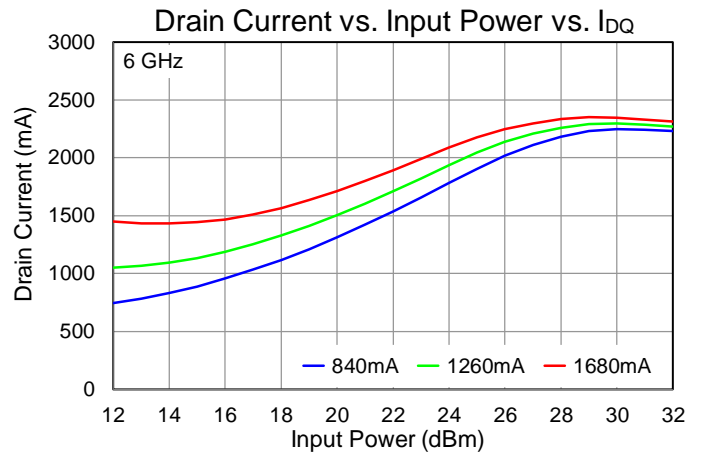
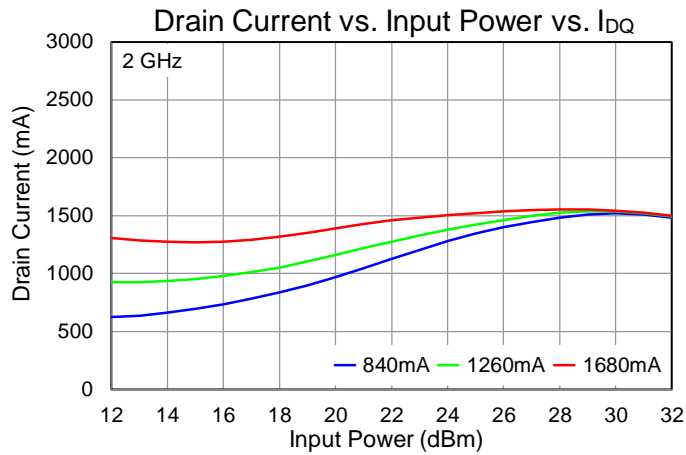

Performance Plots – Linearity

Test conditions, unless otherwise noted: $V_D = 22\text{ V}$, $I_{DQ} = 1680\text{ mA}$, $T = +25\text{ }^\circ\text{C}$, 100 MHz tone spacing

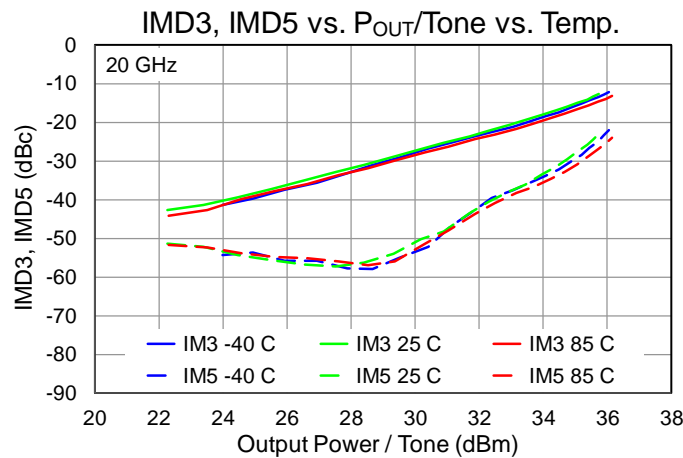
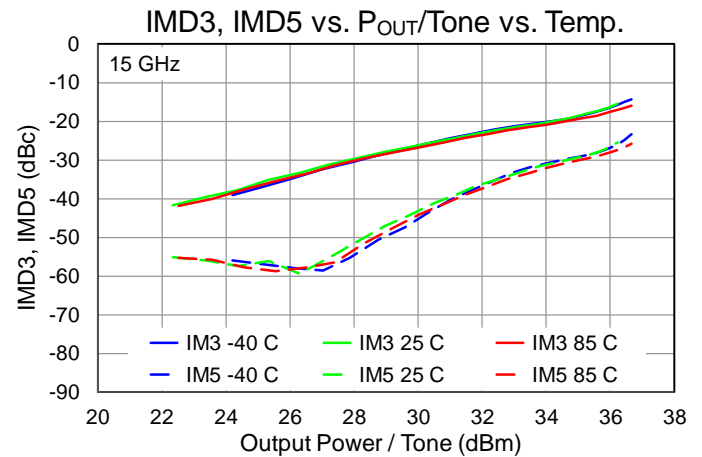
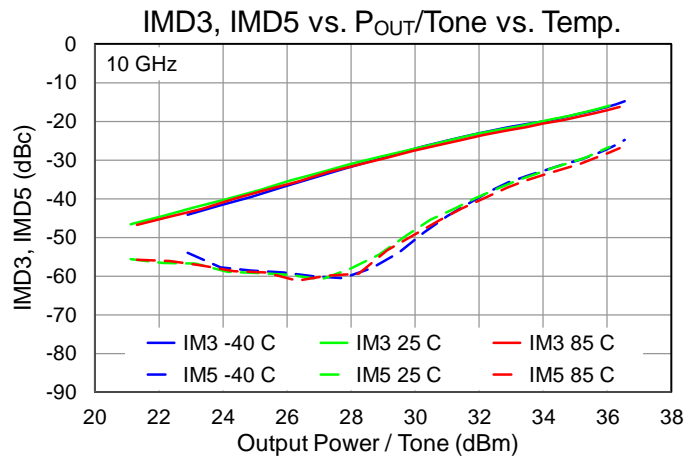
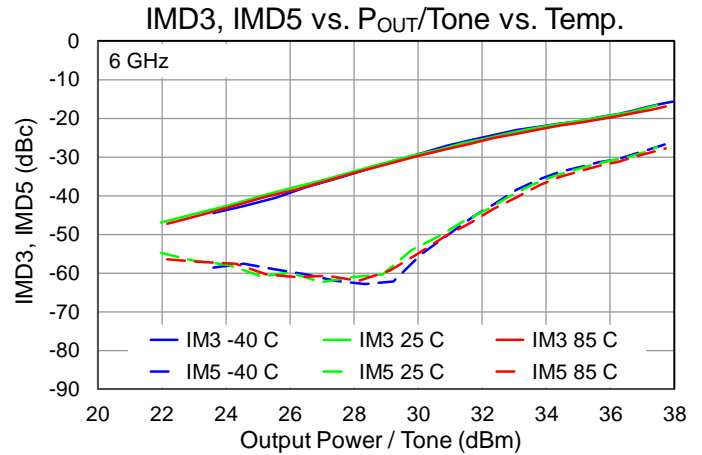
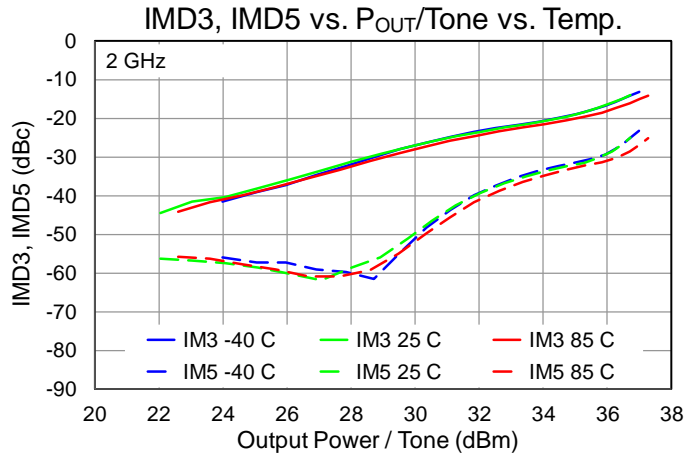

Performance Plots – Linearity

Test conditions, unless otherwise noted: $V_D = 22\text{ V}$, $I_{DQ} = 1680\text{ mA}$, $T = +25\text{ }^\circ\text{C}$, 100 MHz tone spacing

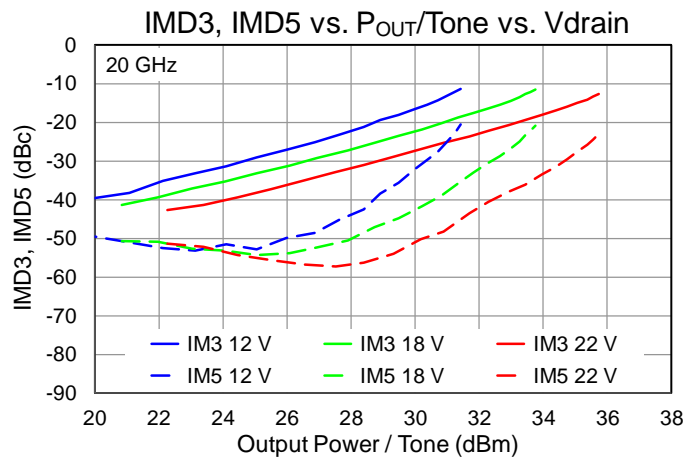
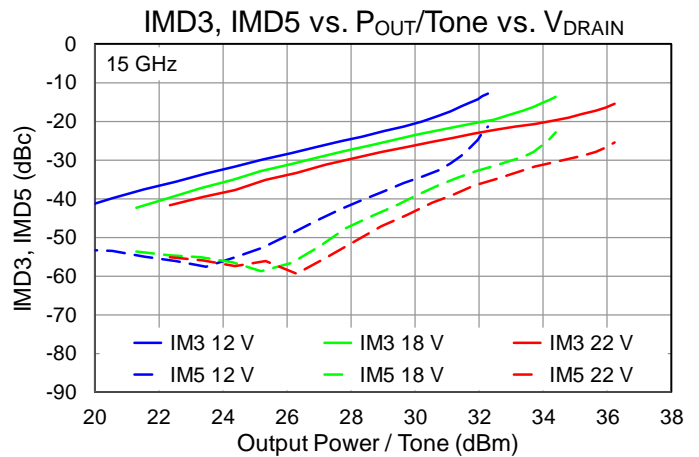
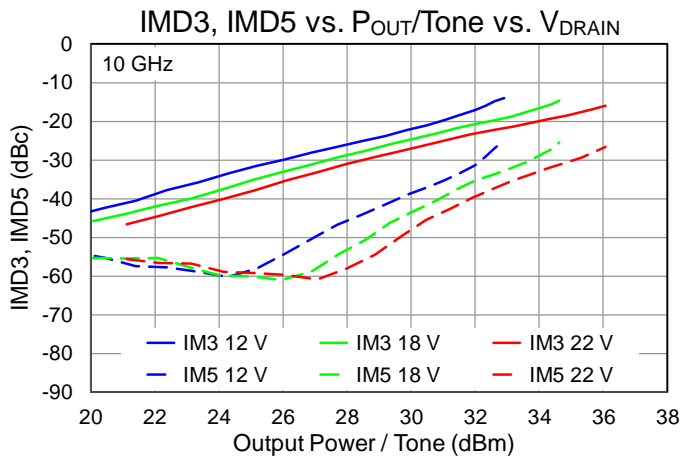
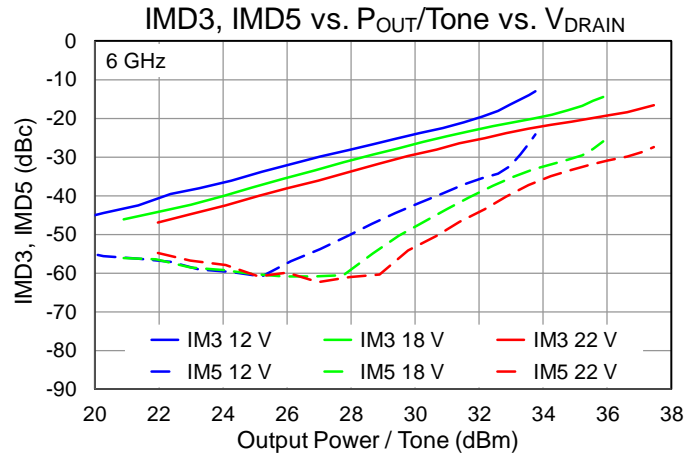
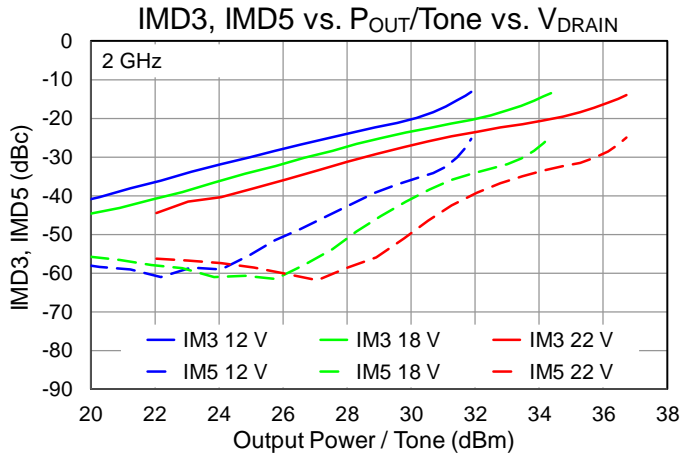

Performance Plots – Linearity

Test conditions, unless otherwise noted: $V_D = 22\text{ V}$, $I_{DQ} = 1680\text{ mA}$, $T = +25\text{ }^\circ\text{C}$, 100 MHz tone spacing

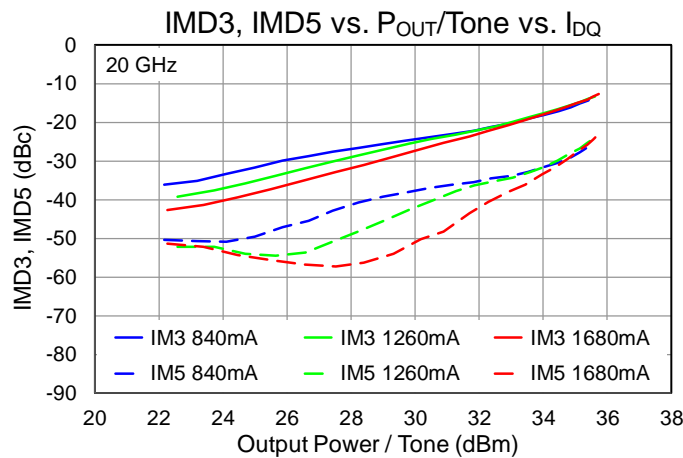
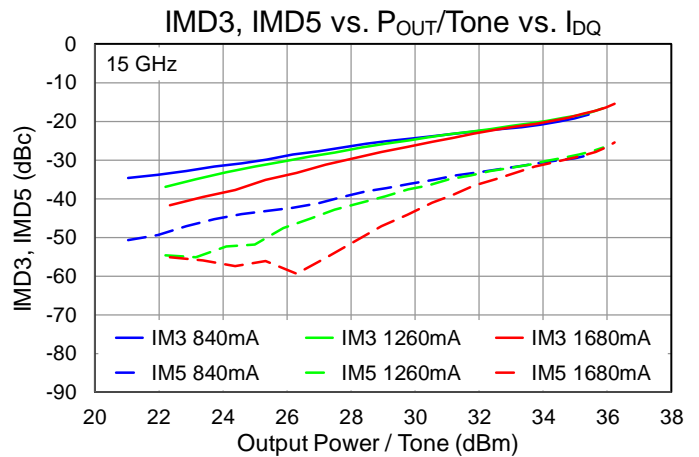
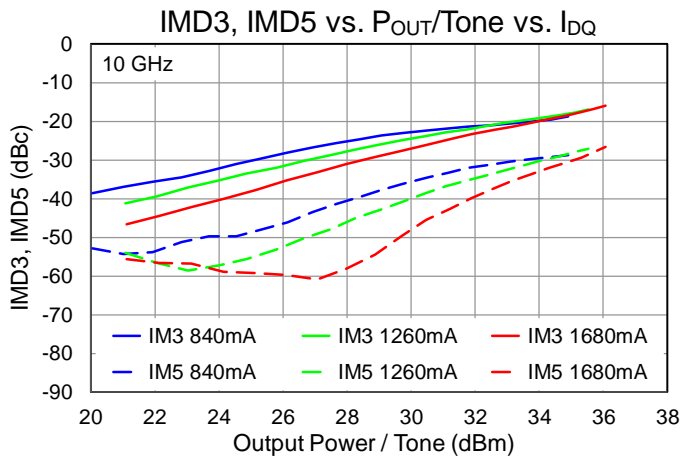
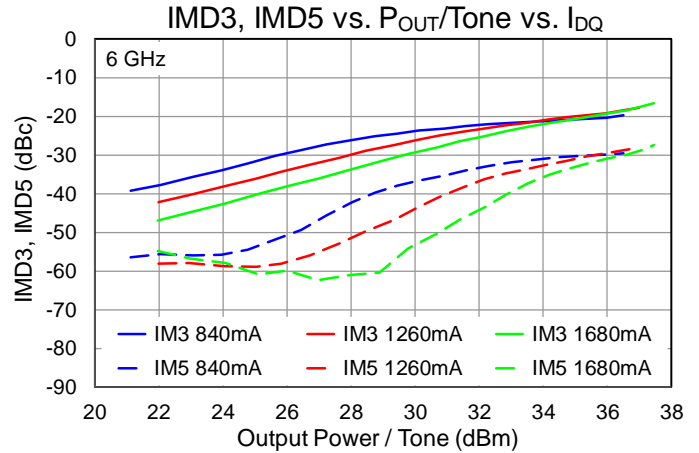
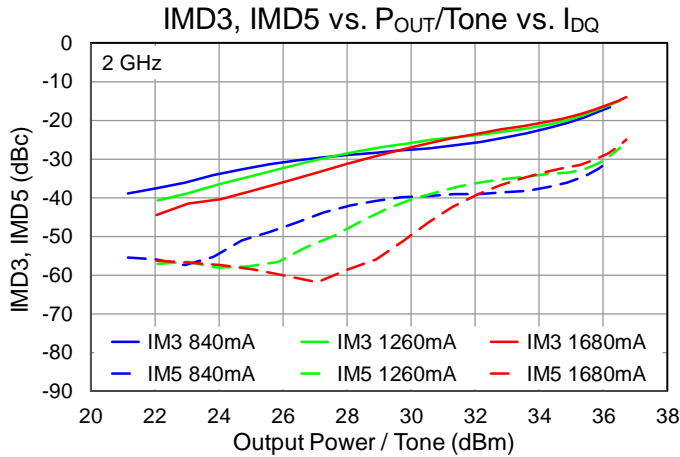

Performance Plots – Harmonics

Test conditions, unless otherwise noted: $V_D = 22\text{ V}$, $I_{DQ} = 1680\text{ mA}$, $T = +25\text{ }^\circ\text{C}$, $P_{in} = 27\text{ dBm}$

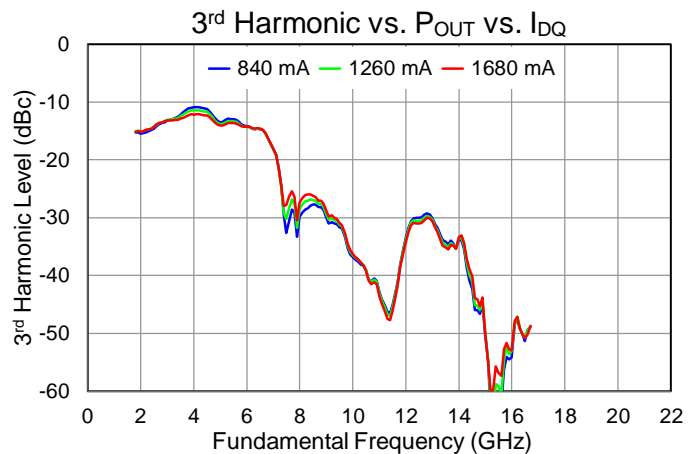
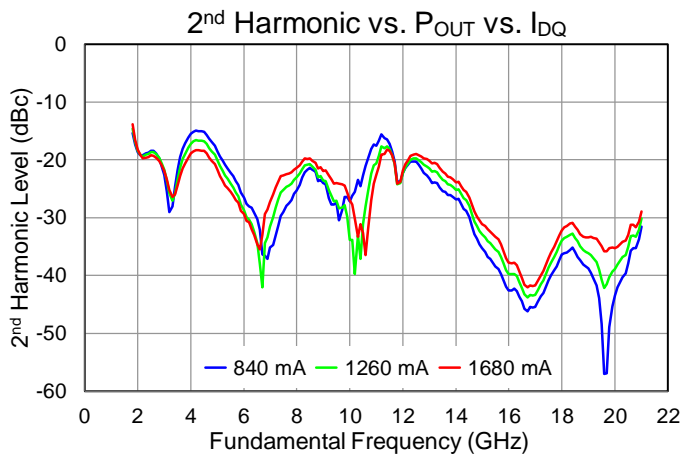
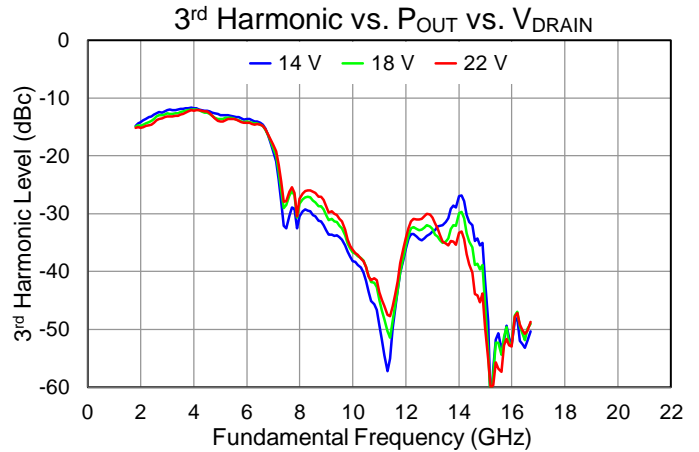
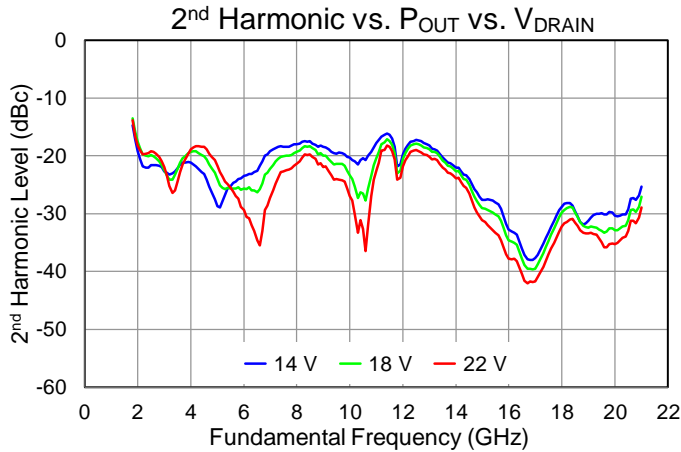
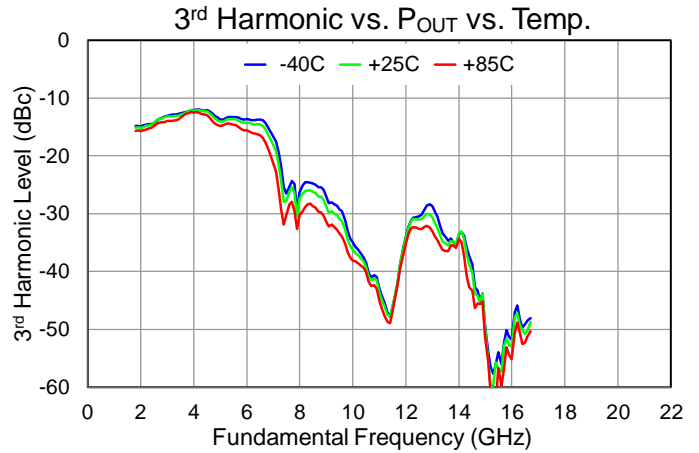
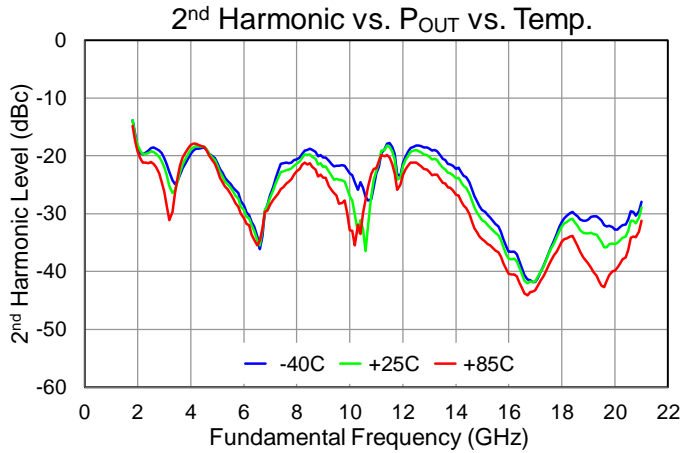

Thermal and Reliability Information

Parameter	Test Conditions	Value	Units
Thermal Resistance (θ_{JC}) ⁽¹⁾	$T_{base} = 85\text{ }^{\circ}\text{C}$, $V_D = 22\text{ V}$, $I_{DQ} = 1680\text{ mA}$, $P_{DISS} = 36.96\text{ W}$, No RF (quiescent DC operation)	2.513	$^{\circ}\text{C/W}$
Channel Temperature, T_{CH} (Under RF) ⁽²⁾		177.9	$^{\circ}\text{C}$
Thermal Resistance (θ_{JC}) ⁽¹⁾	$T_{base} = 85\text{ }^{\circ}\text{C}$, $V_D = 22\text{ V}$, $I_{DQ} = 1680\text{ mA}$, Freq = 7.5 GHz, $I_{D_Drive} = 2265\text{ mA}$, $P_{in} = 27\text{ dBm}$, $P_{OUT} = 41.0\text{ dBm}$, $P_{DISS} = 37.81\text{ W}$	2.609	$^{\circ}\text{C/W}$
Channel Temperature, T_{CH} (Under RF) ⁽²⁾		183.6	$^{\circ}\text{C}$

Notes:

1. Thermal resistance determined to the back of package (85 °C)
2. Refer to the following document: [GaN Device Channel Temperature, Thermal Resistance, and Reliability Estimates](#)

Dissipated Power

Test conditions, unless otherwise noted:
 $V_D = 22\text{ V}$, $I_{DQ} = 1680\text{ mA}$, $T = +25\text{ }^{\circ}\text{C}$, $P_{IN} = 27\text{ dBm}$

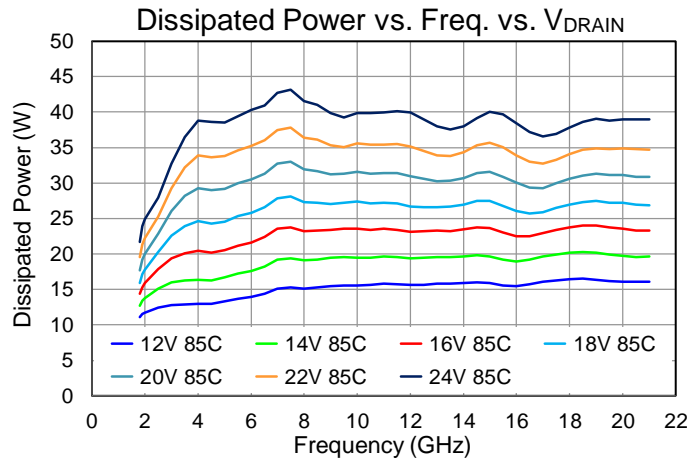

Applications Information

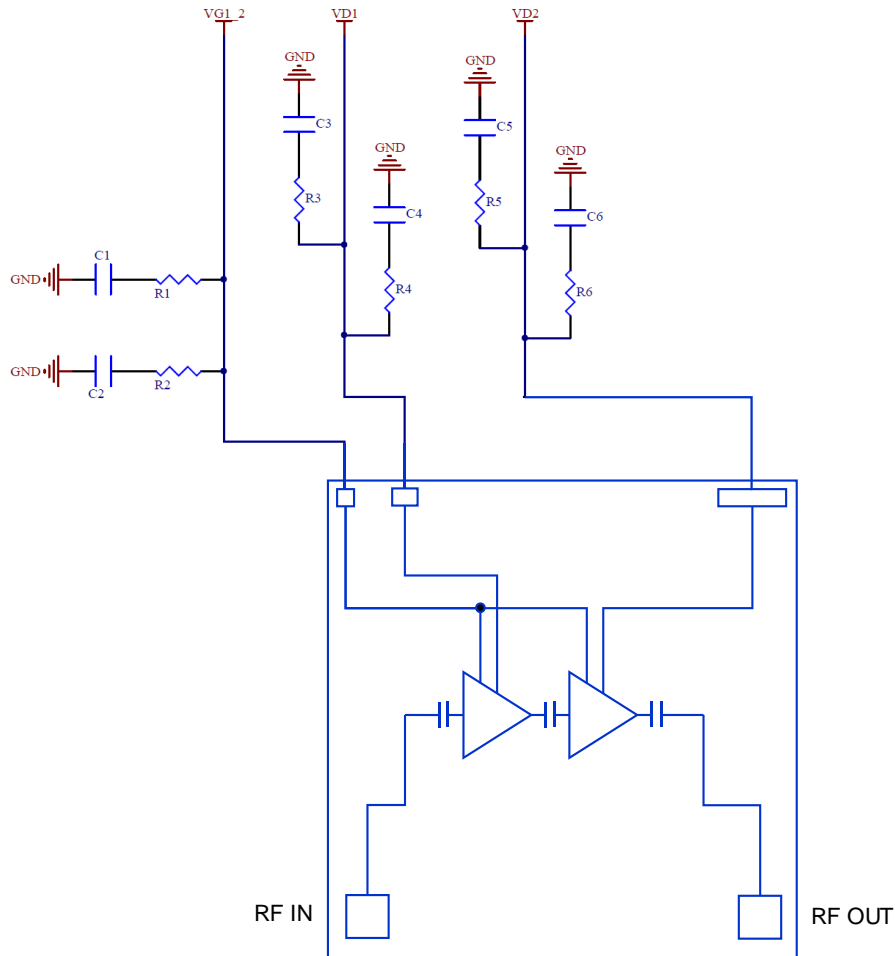

Top View
VD1 and VD2 may be tied together

Bias-Up Procedure

1. Set I_D limit to 3000 mA, I_G limit to 10 mA
2. Set V_G to -4.0 V
3. Set V_D +22 V
4. Adjust V_G more positive until $I_{DQ} \approx 1680$ mA
5. Apply RF signal

Bias-Down Procedure

1. Turn off RF signal
2. Reduce V_G to -4.0 V. Ensure $I_{DQ} \sim 0$ mA
4. Set V_D to 0 V
5. Turn off V_D supply
6. Turn off V_G supply

Evaluation Board (EVB) Layout Assembly

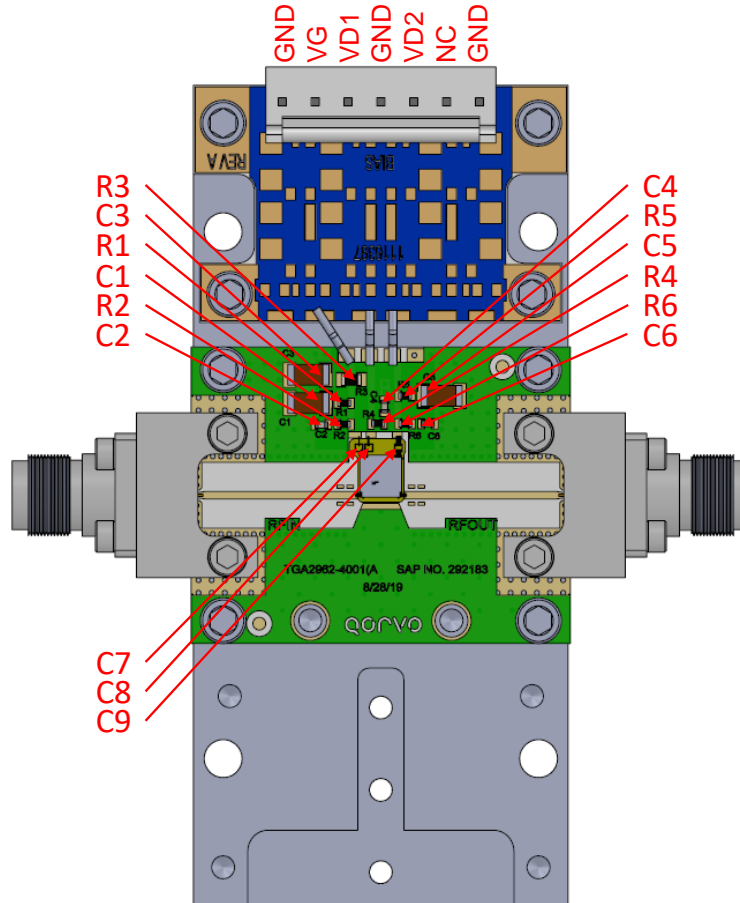

PCB is made from Rogers 6035HTC dielectric, .010 inch thick, 0.5 oz. copper both sides.

Bill of Materials

Reference Des.	Value	Description	Manuf.	Part Number
C1, C3, C5	10 uF	CAP, 10 uF, 20%, 50 V, 20%, X5R, 1206	Various	
C2, C4, C6	0.01 uF	CAP, 0.01 uF, 10%, 50 V, X7R, 0402	Various	
C7, C8, C9	820 pF	CAP, 820pF, 10%, 50V, SL, BORDER	Various	
R1	5.1 Ω	RES, 5.1 OHM, 5%, 50 V, 0402	Various	
R3	5.1 Ω	RES, 5.1 OHM, 5%, 0.1W, 0603	Various	
R2, R4, R5, R6	0 Ω	RES, 0 OHM, JMPR, 0402	Various	
J1, J2	2.92 mm	CONNECTOR, FEMALE, ENDLAUNCH	Southwest Microwave	1092-01A-5

Mechanical Information

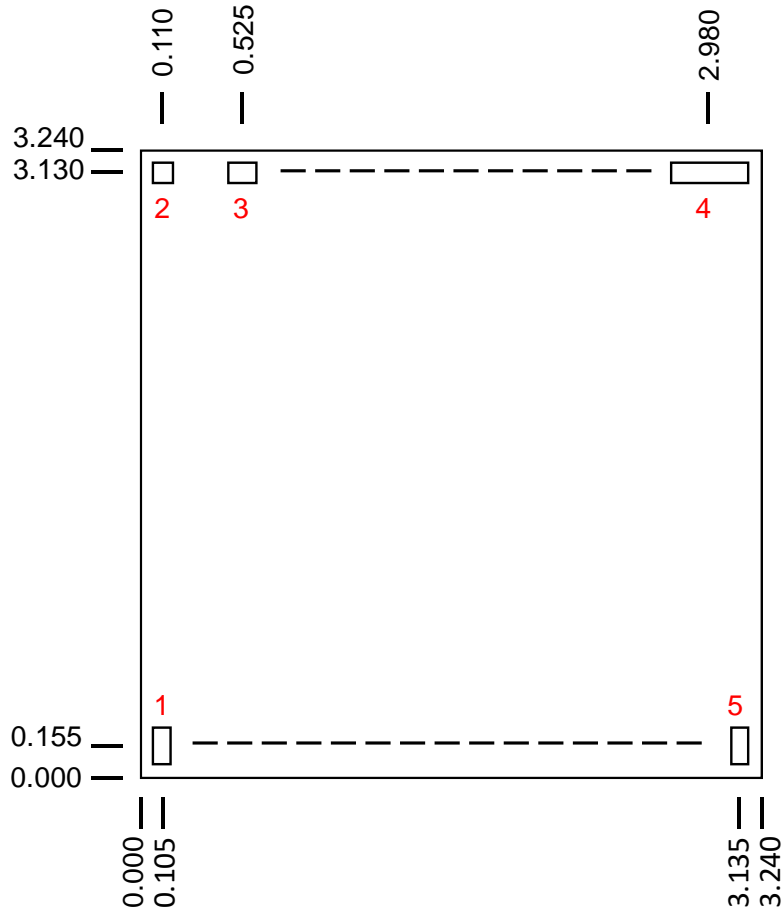

Dimensions are in mm
Thickness: 0.100
Die x, y size tolerance: ± 0.050
Ground is backside of die

Bond Pad Description

Pad No.	Symbol	Pad Size (um)	Description
1	RF IN	90 x 190	RF input. 50 Ohms. DC blocked.
2	VG	100 x 100	Gate voltage. Bypass network required; refer to page 24.
3	VD1	150 x 100	Drain voltage, stage 1. Bypass network required; refer to page 23.
4	VD2	400 x 100	Drain voltage, stage 2. Bypass network required; refer to page 23.
5	RF OUT	90 x 190	RF output. 50 Ohms. DC blocked.

Assembly Notes

Component placement and adhesive attachment assembly notes:

- Vacuum pencils and/or vacuum collets are the preferred method of pick up.
- Air bridges must be avoided during placement.
- The force impact is critical during auto placement.

Reflow process assembly notes:

- Use AuSn (80/20) solder and limit exposure to temperatures above 300 °C to 3–4 minutes, maximum.
- An alloy station or conveyor furnace with reducing atmosphere should be used.
- Do not use any kind of flux.
- Coefficient of thermal expansion matching is critical for long-term reliability.
- Devices must be stored in a dry nitrogen atmosphere.

Interconnect process assembly notes:

- Thermosonic ball bonding is the preferred interconnect technique.
- Force, time, and ultrasonic are critical parameters.
- Aluminum wire should not be used.
- Devices with small pad sizes should be bonded with 0.0007-inch wire.

Handling Precautions

Parameter	Rating	Standard	 Caution! ESD-Sensitive Device
ESD – Human Body Model (HBM)	0B	ANSI/ESD/JEDEC JS-001	

Solderability

Use only AuSn (80/20) solder, and limit exposure to temperatures above 300 °C to 3–4 minutes, maximum.

RoHS Compliance

This part is compliant with 2011/65/EU RoHS directive (Restrictions on the Use of Certain Hazardous Substances in Electrical and Electronic Equipment) as amended by Directive 2015/863/EU.

This product also has the following attributes:

- Lead Free
- Halogen Free (Chlorine, Bromine)
- Antimony Free
- TBBP-A (C₁₅H₁₂Br₄O₂) Free
- SVHC Free

Contact Information

For the latest specifications, additional product information, worldwide sales and distribution locations:

Web: www.qorvo.com

Tel: 1-844-890-8163

Email: customer.support@qorvo.com

Important Notice

The information contained herein is believed to be reliable; however, Qorvo makes no warranties regarding the information contained herein and assumes no responsibility or liability whatsoever for the use of the information contained herein. All information contained herein is subject to change without notice. Customers should obtain and verify the latest relevant information before placing orders for Qorvo products. The information contained herein or any use of such information does not grant, explicitly or implicitly, to any party any patent rights, licenses, or any other intellectual property rights, whether with regard to such information itself or anything described by such information. **THIS INFORMATION DOES NOT CONSTITUTE A WARRANTY WITH RESPECT TO THE PRODUCTS DESCRIBED HEREIN, AND QORVO HEREBY DISCLAIMS ANY AND ALL WARRANTIES WITH RESPECT TO SUCH PRODUCTS WHETHER EXPRESS OR IMPLIED BY LAW, COURSE OF DEALING, COURSE OF PERFORMANCE, USAGE OF TRADE OR OTHERWISE, INCLUDING THE IMPLIED WARRANTIES OF MERCHANTABILITY AND FITNESS FOR A PARTICULAR PURPOSE.**

Without limiting the generality of the foregoing, Qorvo products are not warranted or authorized for use as critical components in medical, life-saving, or life-sustaining applications, or other applications where a failure would reasonably be expected to cause severe personal injury or death.

Copyright 2021 © Qorvo, Inc. | Qorvo is a registered trademark of Qorvo, Inc.