

Product Overview

The CMD293 is a wideband medium power GaAs MMIC driver amplifier ideally suited for military, space and communications systems where small size and high linearity are needed. At 30 GHz the device delivers 20 dB of gain with a corresponding output 1 dB compression point of +26 dBm and noise figure of 6 dB. The CMD293 integrates a temperature compensated RF power detection circuit that enables power detection at 0.7 V/W at 30 GHz. The device is a 50 ohm matched design which eliminates the need for external DC blocks and RF port matching. The CMD293 offers full passivation for increased reliability and moisture protection.

Key Features

- Wideband Performance
- High Gain
- High Linearity
- Integrated RF Power Detector
- AMMC-6345 Replacement
- Small Die Size: 2570 um x 1570 um

Ordering Information

Part No.	Description
CMD293	20-45 GHz Driver Amplifier, 25 Piece Gel Pack

Functional Block Diagram

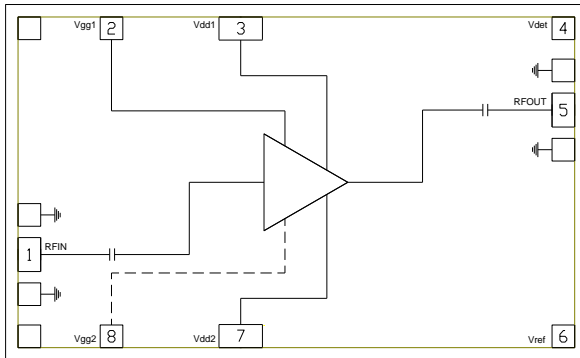

Electrical Performance ($V_{dd} = 5.0 \text{ V}$, $I_{dd} = 480 \text{ mA}$, $T_A = 25 \text{ }^\circ\text{C}$, $F = 30 \text{ GHz}$)

Parameter	Min	Typ	Max	Units
Frequency Range		20 - 45		GHz
Gain		20		dB
Noise Figure		6		dB
Input Return Loss		20		dB
Output Return Loss		25		dB
Output P1dB		26		dBm
Output IP3		31.5		dBm
Supply Current		480		mA

Absolute Maximum Ratings

Parameter	Rating
Drain Voltage, V_{dd}	5.5 V
RF Input Power	+23 dBm
Channel Temperature, T_{ch}	150 °C
Power Dissipation, P_{diss}	3.346 W
Thermal Resistance, θ_{JC}	19.43 °C/W
Operating Temperature	-55 to 85 °C
Storage Temperature	-55 to 150 °C

Exceeding any one or combination of the maximum ratings may cause permanent damage to the device.

Recommended Operating Conditions

Parameter	Min	Typ	Max	Units
V_{dd}	3.0	5.0	5.25	V
I_{dd}		480		mA
V_{gg}		-0.45		V

Electrical performance is measured at specific test conditions. Electrical specifications are not guaranteed over all recommended operating conditions.

Electrical Specifications ($V_{dd} = 5.0$ V, $I_{dd} = 480$ mA, $T_A = 25$ °C)

Parameter	Min	Typ	Max	Min	Typ	Max	Min	Typ	Max	Units
Frequency Range	20 - 24			24 - 34			34 - 45			GHz
Gain	17.5	20.5		16	20		14.5	21		dB
Noise Figure		6			5.75			6		dB
Input Return Loss		13			18			17		dB
Output Return Loss		25			20			15		dB
Output P1dB	21	25		22.5	26		20.5	24		dBm
Output IP3		32			31.5			30.5		dBm
Supply Current		480	560		480	560		480	560	mA
Gain Temperature Coefficient		0.04			0.04			0.04		dB/°C
Noise Figure Temp. Coefficient		0.015			0.015			0.015		dB/°C

Typical Performance

Broadband Performance, $V_{dd} = 5.0 \text{ V}$, $I_{dd} = 480 \text{ mA}$, $T_A = 25 \text{ }^\circ\text{C}$

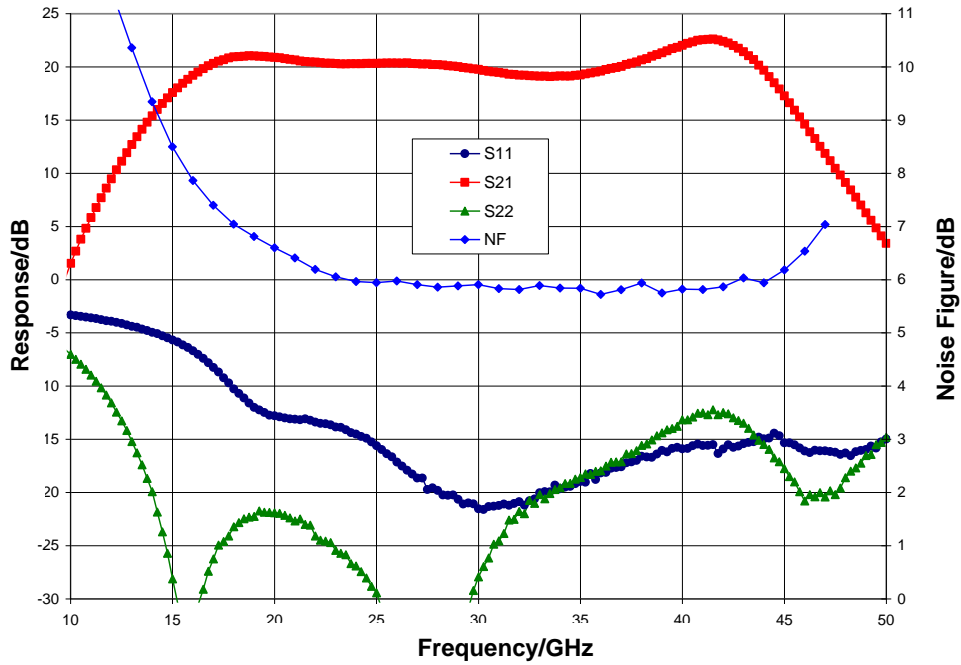

Narrow-band Performance, $V_{dd} = 5.0 \text{ V}$, $I_{dd} = 480 \text{ mA}$, $T_A = 25 \text{ }^\circ\text{C}$

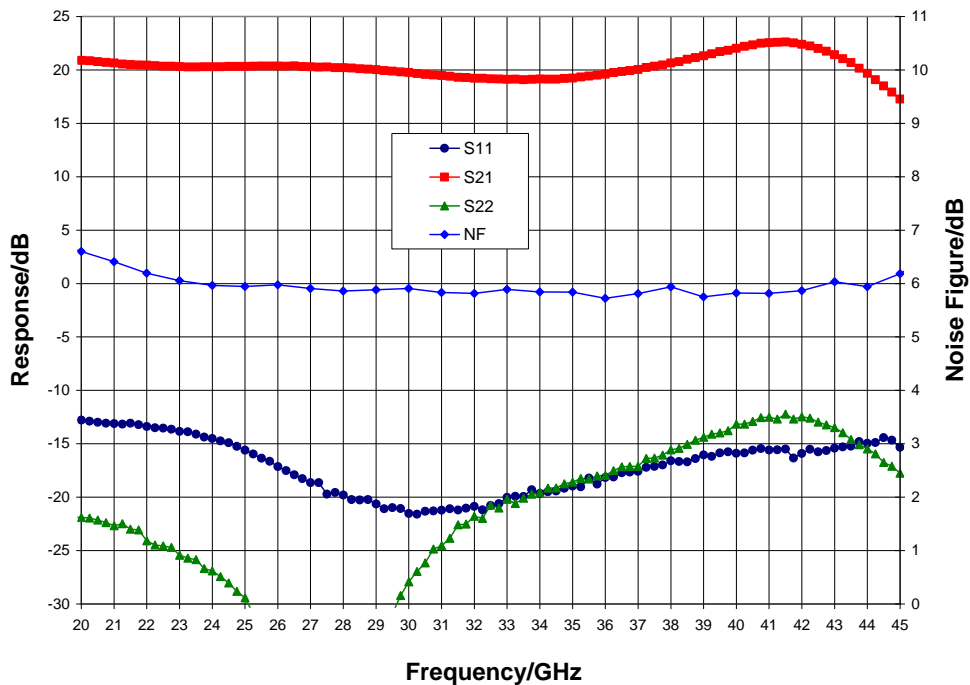

Typical Performance

Gain vs. Temperature, $V_{dd} = 5.0\text{ V}$

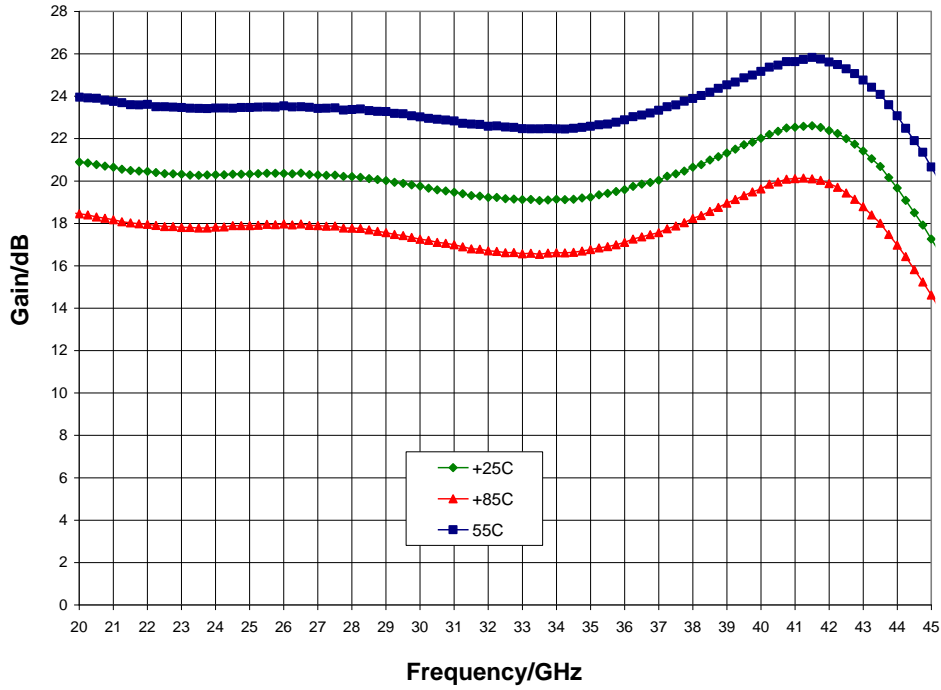

Gain vs. V_{dd} , $I_{dd} = 480\text{ mA}$, $T_A = 25\text{ °C}$

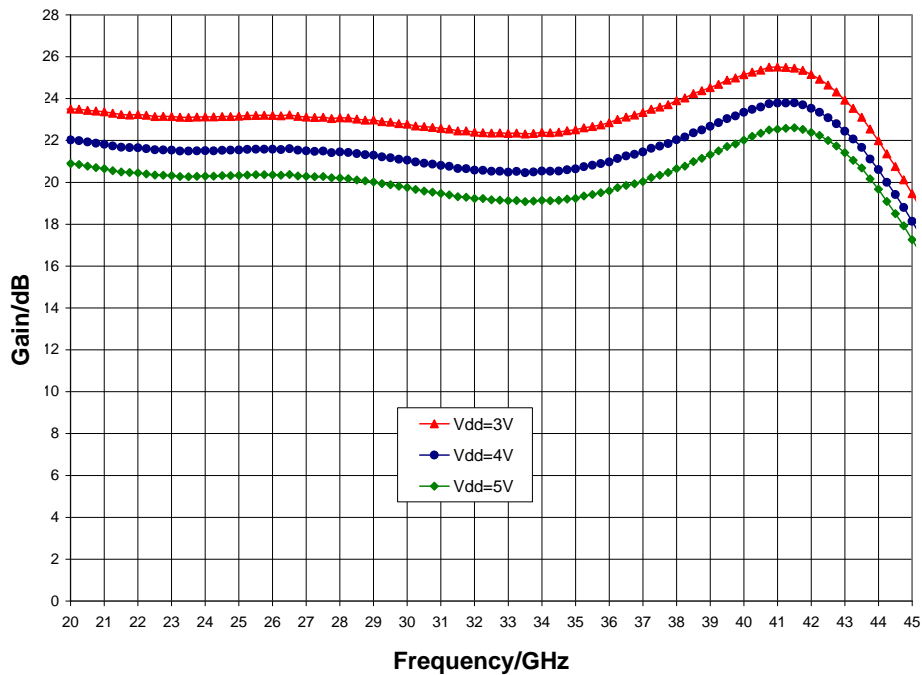

Typical Performance

Noise Figure vs. Temperature, $V_{dd} = 5.0\text{ V}$

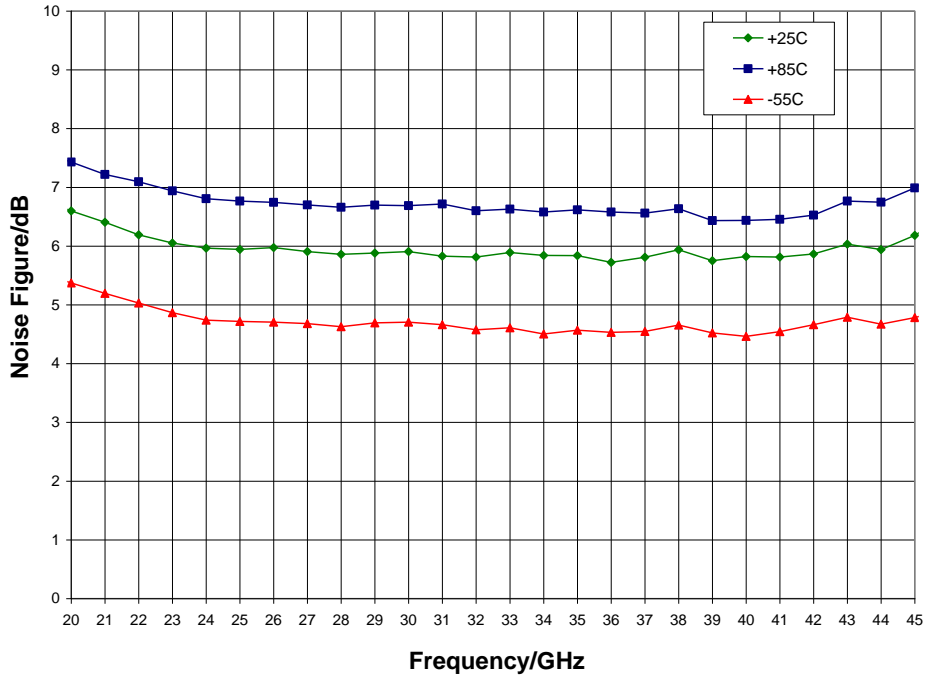

Noise Figure vs. V_{dd} , $I_{dd} = 480\text{ mA}$, $T_A = 25\text{ °C}$

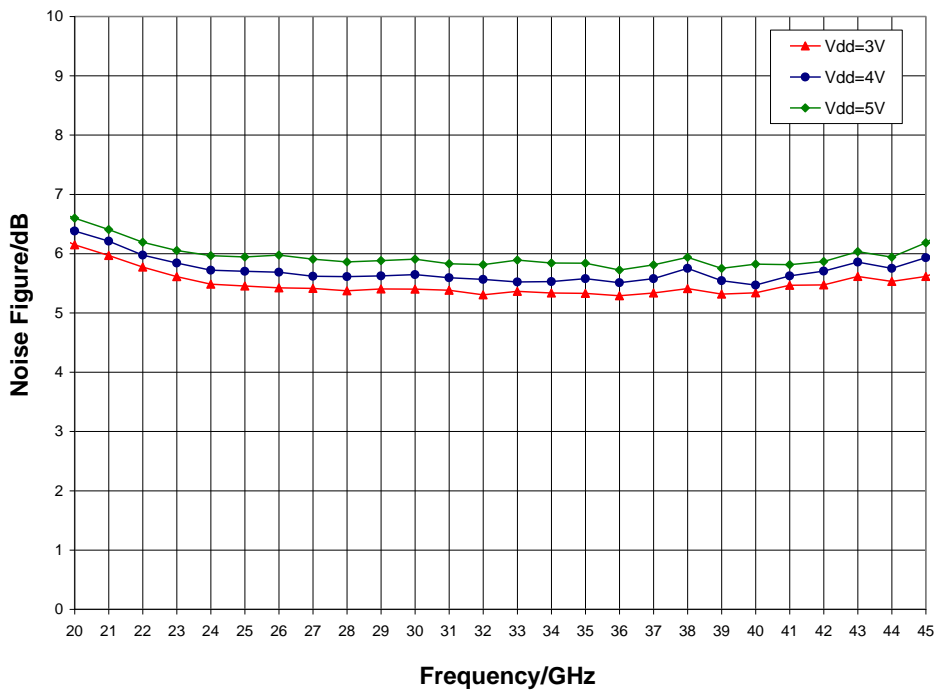

Typical Performance

P1dB vs. Temperature, $V_{dd} = 5.0\text{ V}$

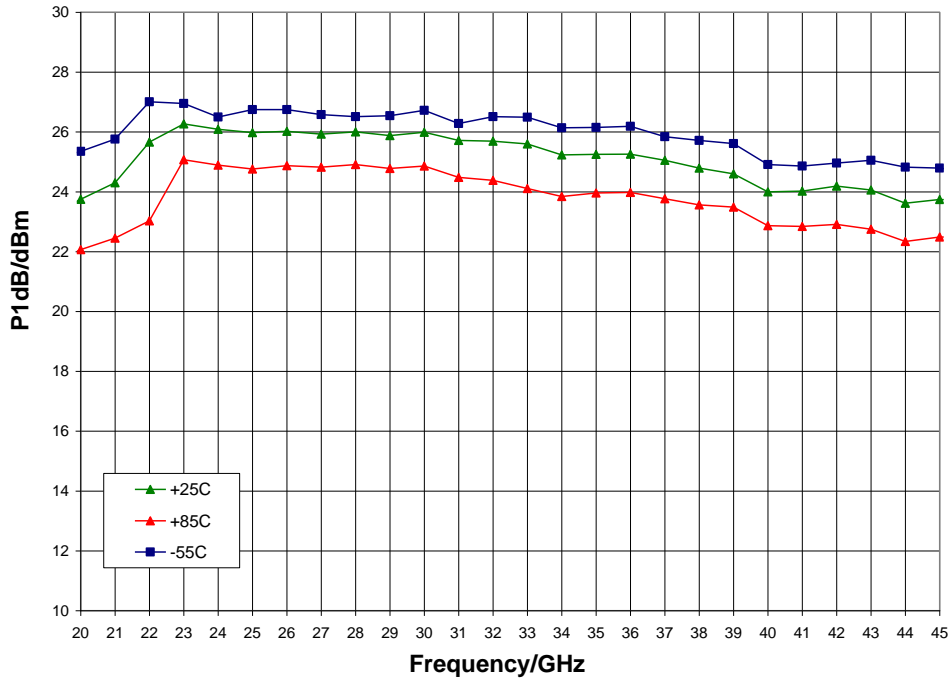

P1dB vs. V_{dd} , $I_{dd} = 480\text{ mA}$, $T_A = 25\text{ °C}$

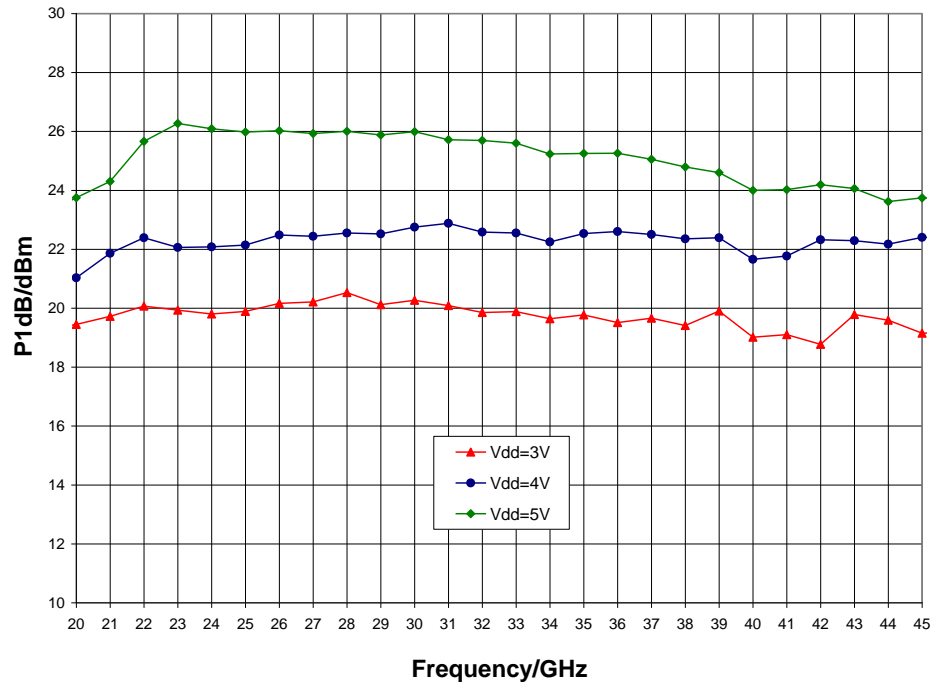

Typical Performance

Psat vs. Temperature, V_{dd} = 5.0 V

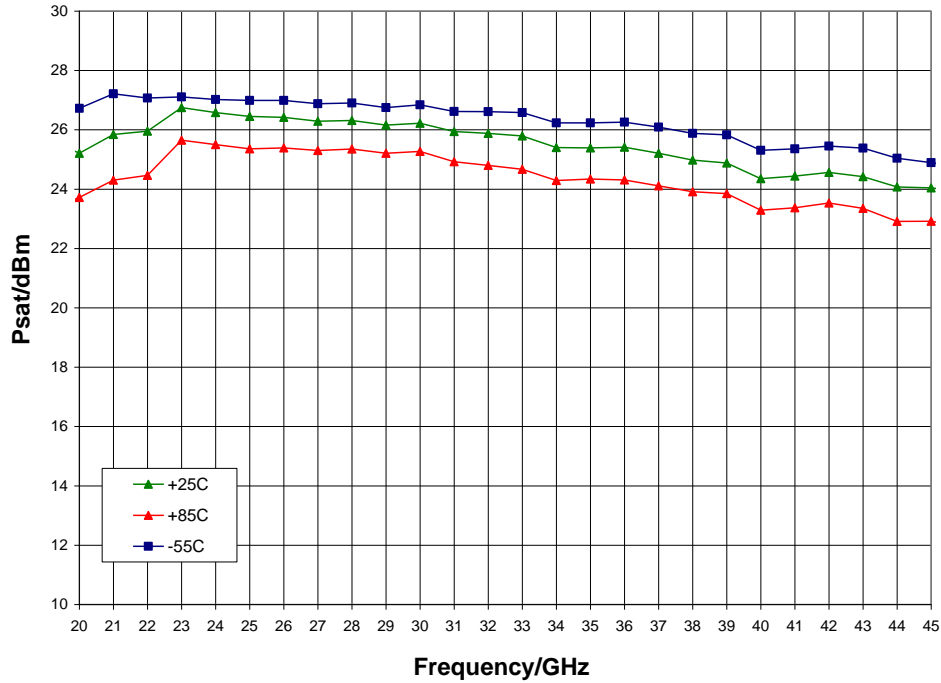

Psat vs. V_{dd}, I_{dd} = 480 mA, T_A = 25 °C

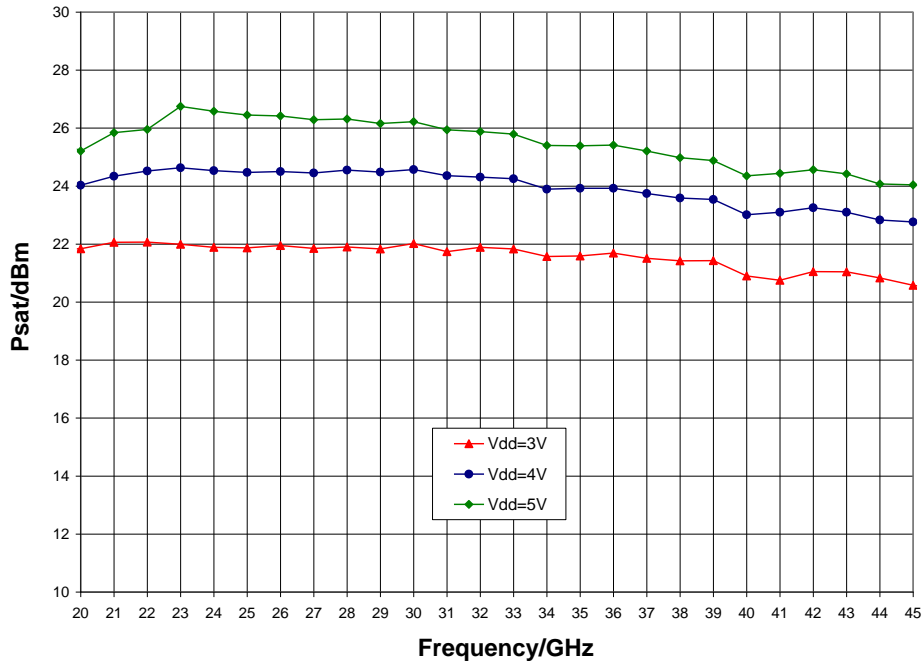

Typical Performance

Output IP3 vs. Temperature, $V_{dd} = 5.0\text{ V}$

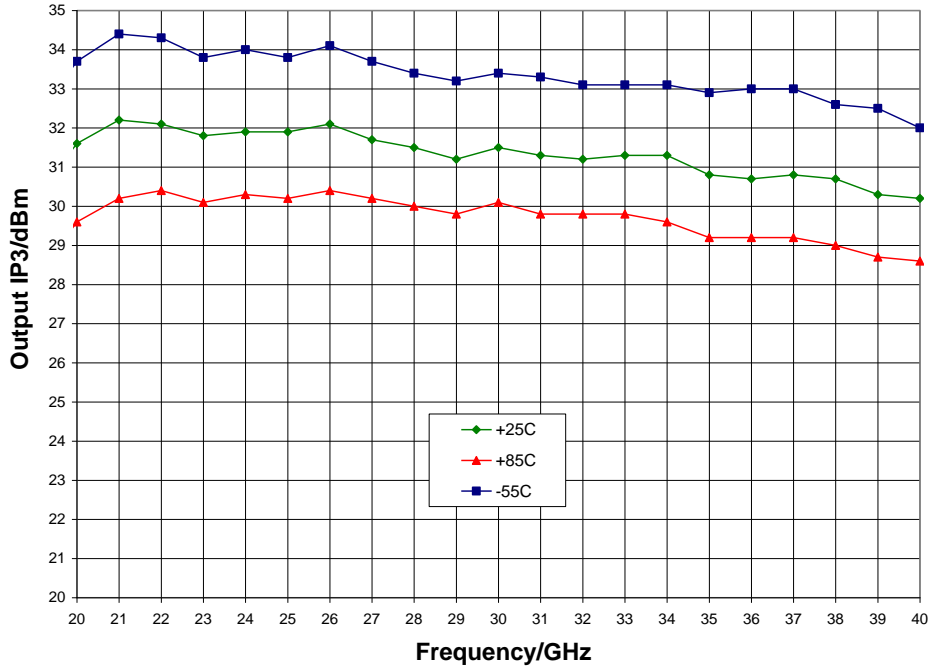

Output IP3 vs. V_{dd} , $I_{dd} = 480\text{ mA}$, $T_A = 25\text{ °C}$

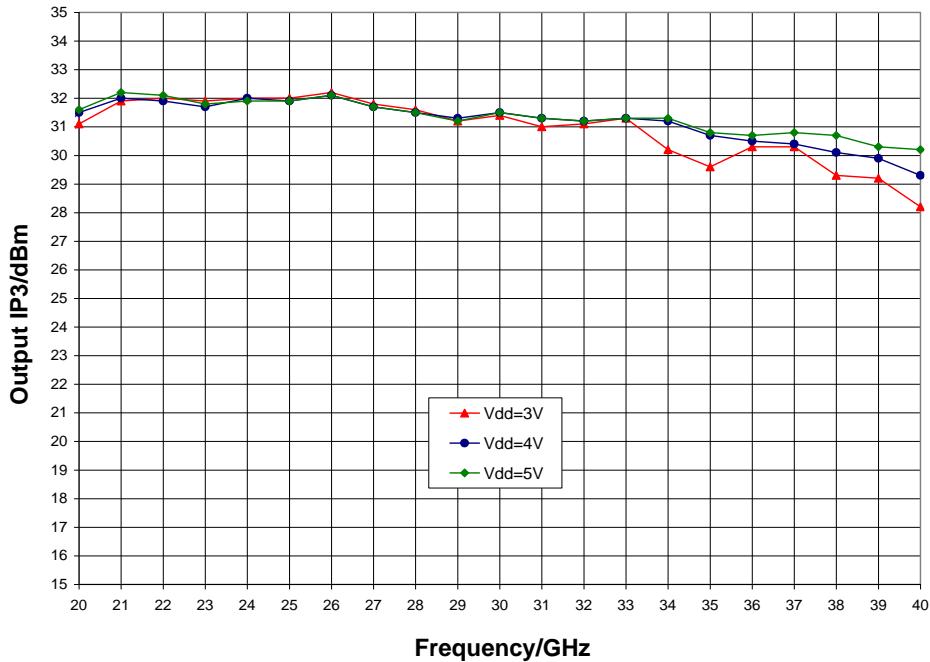

Typical Performance

Detector Voltage ($V_{ref}-V_{det}$), $V_{dd} = 5.0\text{ V}$, $I_{dd} = 480\text{ mA}$, $F = 30\text{ GHz}$

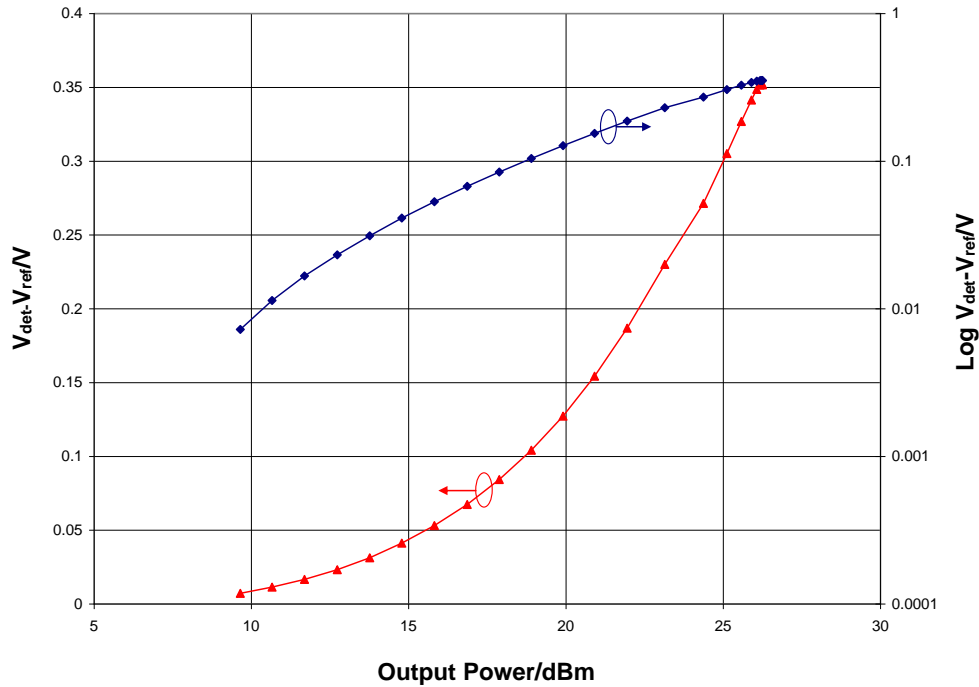

Mechanical Information

Die Outline (all dimensions in microns)

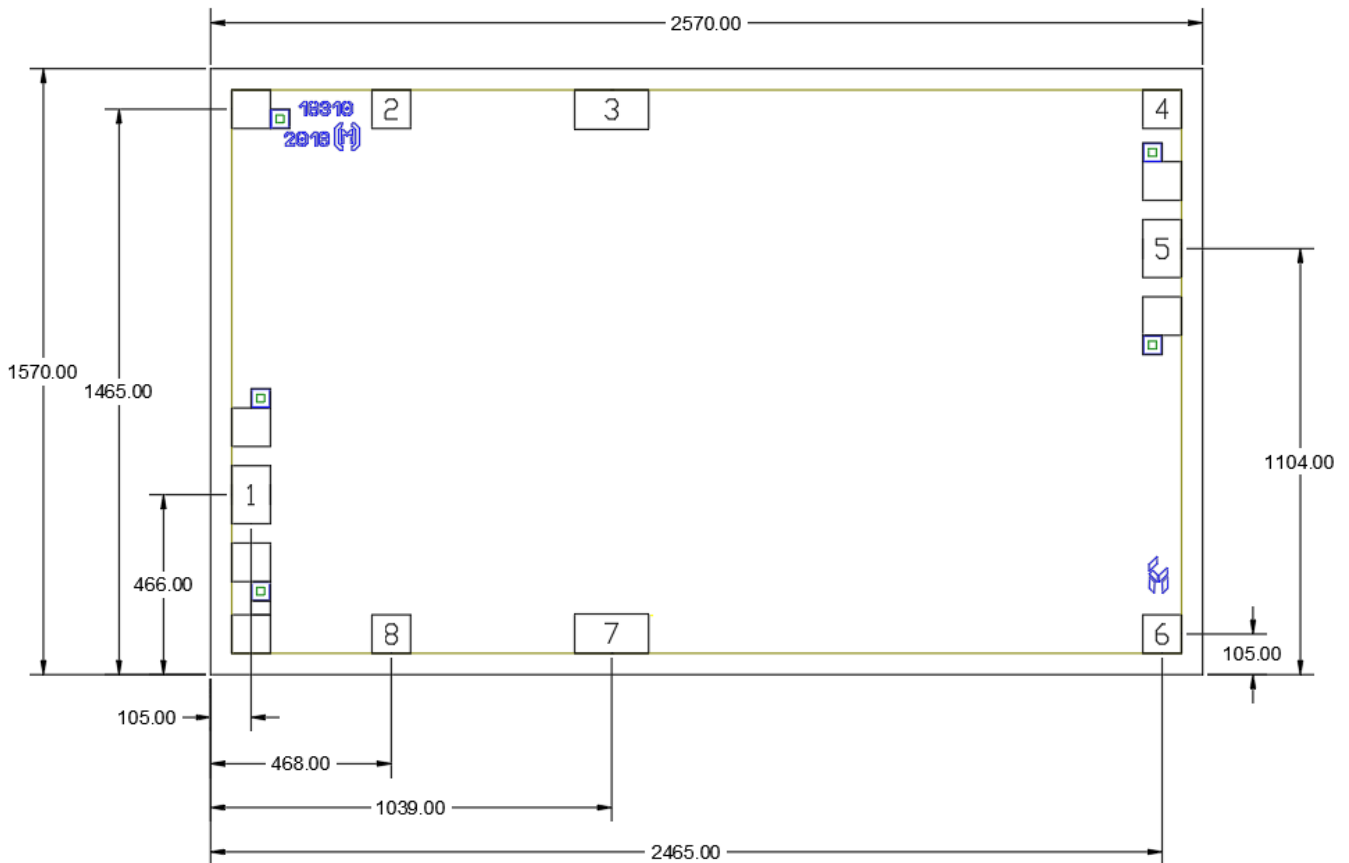

Notes:

1. No connection required for unlabeled pads
2. Backside is RF and DC ground
3. Backside and bond pad metal: Gold
4. Die is 70 microns thick
5. DC bond pads (2, 4, 6, 8) are 100 x 100 microns
6. DC bond pads (3, 7) are 100 x 192 microns
7. RF bond pads (1, 5) are 100 x 150 microns

Pad Description

Pad Diagram

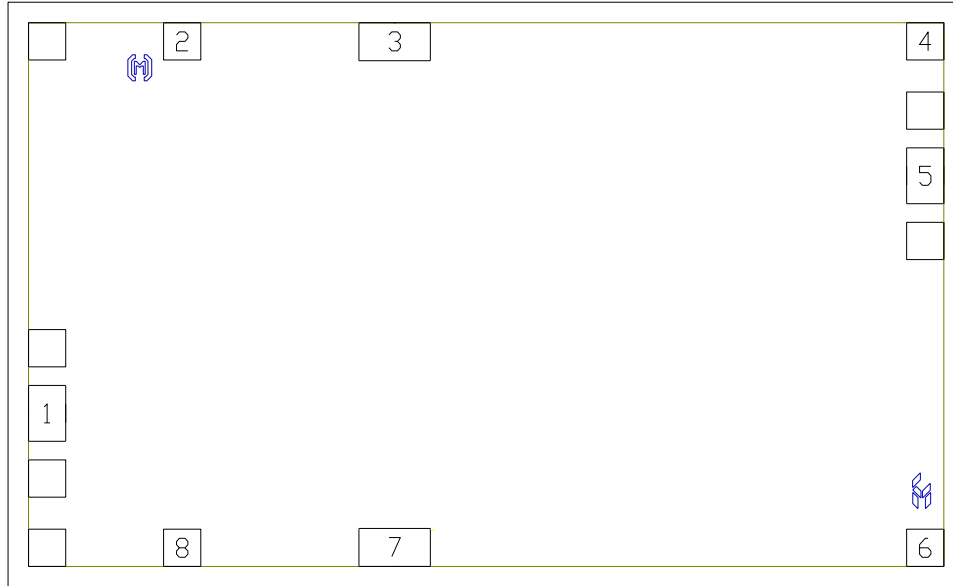

Functional Description

Pad	Function	Description	Schematic
1	RF in	DC blocked and 50 ohm matched	
2, 8	V_{gg1}, V_{gg2}	Power supply voltage Decoupling and bypass caps required Voltage need be applied to only one of these pads	
3, 7	V_{dd1}, V_{dd2}	Power supply voltage Decoupling and bypass caps required	
4, 6	V_{det}, V_{ref}	Power detection circuit	
5	RF out	DC blocked and 50 ohm matched	
Backside	Ground	Connect to RF / DC ground	

Applications Information

Assembly Guidelines

The backside of the CMD293 is RF ground. Die attach should be accomplished with electrically and thermally conductive epoxy or eutectic attach. Standard assembly procedures should be followed for high frequency devices. The top surface of the semiconductor should be made planar to the adjacent RF transmission lines, and the RF decoupling capacitors placed in close proximity to the DC connections on chip.

RF connections should be made as short as possible to reduce the inductive effect of the bond wire. Use of a 0.8 mil thermosonic wedge bonding is highly recommended as the loop height will be minimized. The RF input and output require a double bond wire as shown.

The semiconductor is 70 um thick and should be handled by the sides of the die or with a custom collet. Do not make contact directly with the die surface as this will damage the monolithic circuitry. Handle with care.

Assembly Diagram

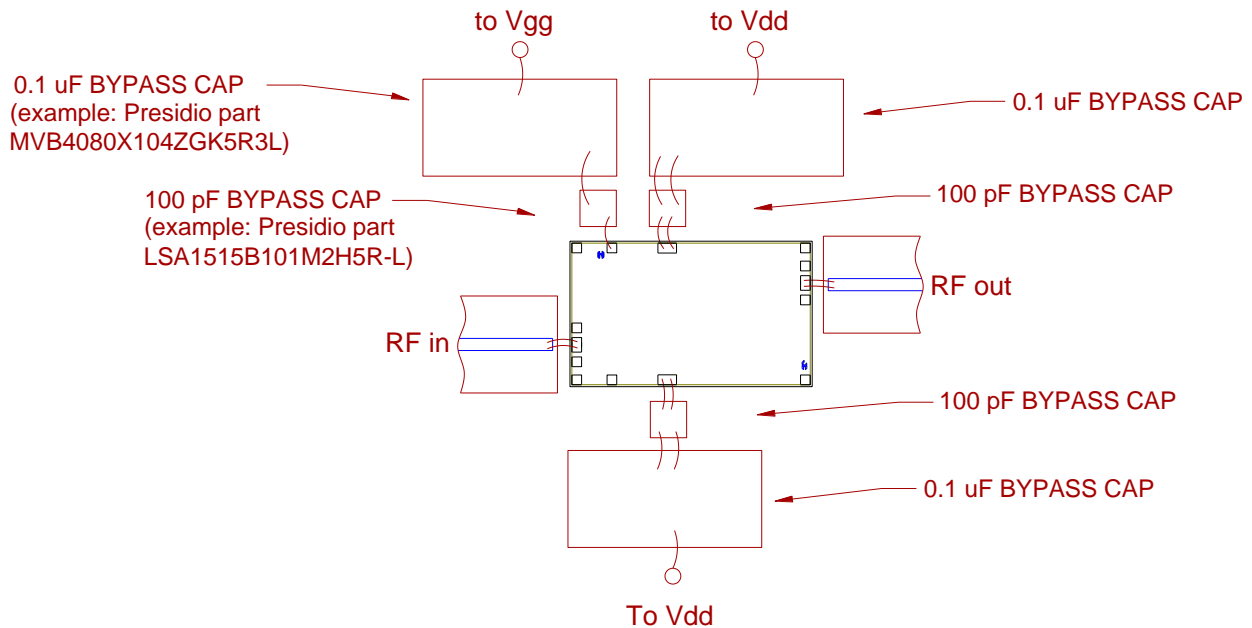

GaAs MMIC devices are susceptible to damage from Electrostatic Discharge. Proper precautions should be observed during handling, assembly and test.

Applications Information

Application Circuit

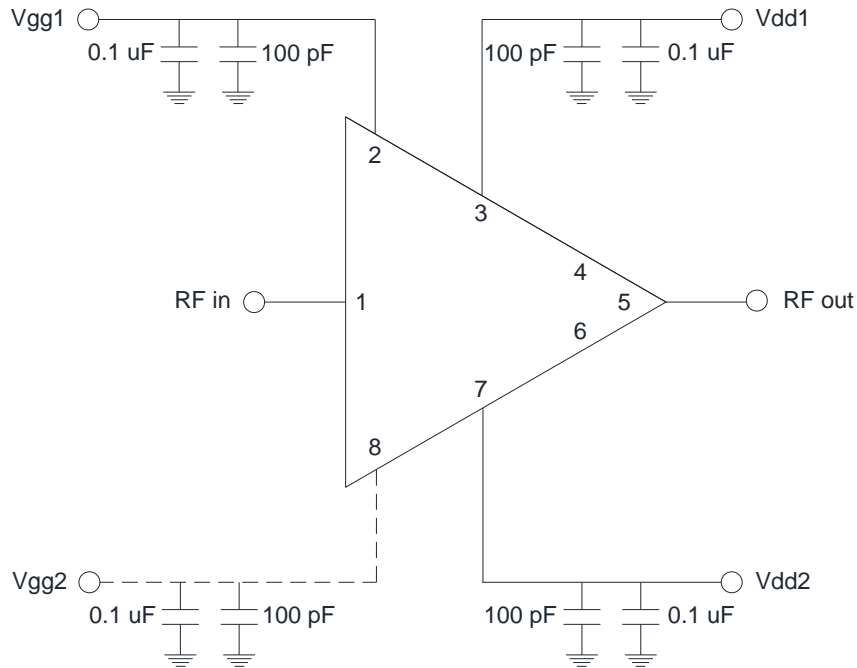

Biasing and Operation

The CMD293 is biased with a positive drain supply and a negative gate supply. Performance is optimized when the drain voltage is set to +5 V, though it may be set to as low as +3 V. The nominal gate voltage is -0.4 V.

Turn ON procedure:

1. Apply gate voltage V_{gg} and set to -2 V
2. Apply drain voltage V_{dd} and set to +5 V
3. Increase V_{gg} (less negative) to achieve a drain current of 480 mA

Turn OFF procedure:

1. Turn off drain voltage V_{dd}
2. Turn off gate voltage V_{gg}

RF power can be applied at any time.

Handling Precautions

Parameter	Rating	Standard
ESD – Human Body Model (HBM)	Class 1A	ESDA / JEDEC JS-001-2012



Caution!
 ESD-Sensitive Device

RoHS Compliance

This part is compliant with 2011/65/EU RoHS directive (Restrictions on the Use of Certain Hazardous Substances in Electrical and Electronic Equipment) as amended by Directive 2015/863/EU.

This product also has the following attributes:

- Lead Free
- Antimony Free
- TBBP-A (C₁₅H₁₂Br₄O₂) Free
- SVHC Free
- Halogen Free
- PFOS Free

Contact Information

For the latest specifications, additional product information, worldwide sales and distribution locations:

Web: www.qorvo.com

Tel: 1-844-890-8163

Email: customer.support@qorvo.com

Important Notice

The information contained in this Data Sheet and any associated documents (“Data Sheet Information”) is believed to be reliable; however, Qorvo makes no warranties regarding the Data Sheet Information and assumes no responsibility or liability whatsoever for the use of said information. All Data Sheet Information is subject to change without notice. Customers should obtain and verify the latest relevant Data Sheet Information before placing orders for Qorvo® products. Data Sheet Information or the use thereof does not grant, explicitly, implicitly or otherwise any rights or licenses to any third party with respect to patents or any other intellectual property whether with regard to such Data Sheet Information itself or anything described by such information.

DATA SHEET INFORMATION DOES NOT CONSTITUTE A WARRANTY WITH RESPECT TO THE PRODUCTS DESCRIBED HEREIN, AND QORVO HEREBY DISCLAIMS ANY AND ALL WARRANTIES WITH RESPECT TO SUCH PRODUCTS WHETHER EXPRESS OR IMPLIED BY LAW, COURSE OF DEALING, COURSE OF PERFORMANCE, USAGE OF TRADE OR OTHERWISE, INCLUDING THE IMPLIED WARRANTIES OF MERCHANTABILITY AND FITNESS FOR A PARTICULAR PURPOSE. Without limiting the generality of the foregoing, Qorvo® products are not warranted or authorized for use as critical components in medical, life-saving, or life-sustaining applications, or other applications where a failure would reasonably be expected to cause severe personal injury or death. Applications described in the Data Sheet Information are for illustrative purposes only. Customers are responsible for validating that a particular product described in the Data Sheet Information is suitable for use in a particular application.

© 2022 Qorvo US, Inc. All rights reserved. This document is subject to copyright laws in various jurisdictions worldwide and may not be reproduced or distributed, in whole or in part, without the express written consent of Qorvo US, Inc. | QORVO® is a registered trademark of Qorvo US, Inc.