

### Product Overview

The CMD244 is wideband GaAs MMIC distributed amplifier die which operates from DC to 24 GHz. The amplifier delivers 18 dB of gain with a corresponding output 1 dB compression point of +25 dBm and noise figure of 2.5 dB at 10 GHz. The CMD244 is a 50 ohm matched design which eliminates the need for RF port matching. The CMD244 offers full passivation for increased reliability and moisture protection. This amplifier is the perfect alternative to higher cost hybrid amplifiers.

### Functional Block Diagram

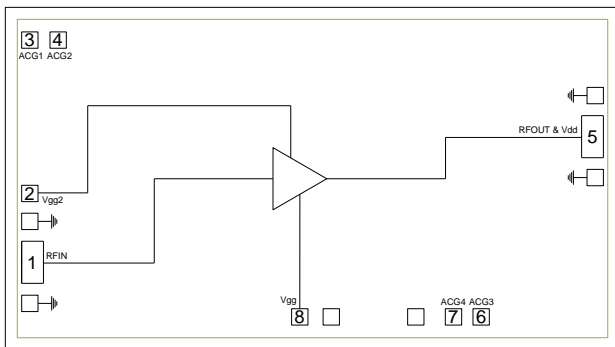

Note:  $V_{gg2}$  is optional for gain control

### Key Features

- Ultra Wideband Performance
- Positive Gain Slope
- High Output Power
- Low Noise Figure
- Small Die Size

### Ordering Information

Part No.	Description
CMD244	DC-24 GHz Distributed Driver Amplifier, 100 Piece Gel Pack

### Electrical Performance ( $V_{dd} = 8.0\text{ V}$ , $V_{gg} = -1.0\text{ V}$ , $T_A = 25\text{ }^\circ\text{C}$ , $F = 10\text{ GHz}$ )

Parameter	Min	Typ	Max	Units
Frequency Range		DC - 24		GHz
Gain		18		dB
Noise Figure		2.5		dB
Input Return Loss		18		dB
Output Return Loss		18		dB
Output P1dB		25		dBm
Supply Current		185		mA

## Absolute Maximum Ratings

Parameter	Rating
Drain Voltage, $V_{dd}$	10 V
Gate Voltage, $V_{gg}$	-4 to 0 V
RF Input Power	+23 dBm
Channel Temperature, $T_{ch}$	150 °C
Power Dissipation, $P_{diss}$	2.4 W
Thermal Resistance, $\theta_{JC}$	26.82 °C/W
Operating Temperature	-55 to 85 °C
Storage Temperature	-55 to 150 °C

Exceeding any one or combination of the maximum ratings may cause permanent damage to the device.

## Recommended Operating Conditions

Parameter	Min	Typ	Max	Units
$V_{dd}$	5.0	8.0	8.5	V
$I_{dd}$		185		mA
$V_{gg}$	-4.0	-1.0	0	V
$I_{gg}$		-1.6		mA

Electrical performance is measured at specific test conditions. Electrical specifications are not guaranteed over all recommended operating conditions.

## Electrical Specifications ( $V_{dd} = 8.0$ V, $V_{gg} = -1.0$ V, $T_A = 25$ °C)

Parameter	Min	Typ	Max	Min	Typ	Max	Units
Frequency Range		DC - 10			10 - 24		GHz
Gain	14.5	17.5		15	18.5		dB
Noise Figure		3			4		dB
Input Return Loss		18			15		dB
Output Return Loss		25			15		dB
Output P1dB	22	25		18	23		dBm
Output IP3		33			31		dBm
Supply Current	130	185	270	130	185	270	mA
Gain Temperature Coefficient		0.010			0.015		dB/°C
Noise Figure Temperature Coefficient		0.01			0.010		dB/°C

Typical Performance

Broadband Performance,  $V_{dd} = 8.0 \text{ V}$ ,  $V_{gg} = -1.0 \text{ V}$ ,  $I_{dd} = 185 \text{ mA}$ ,  $T_A = 25 \text{ }^\circ\text{C}$

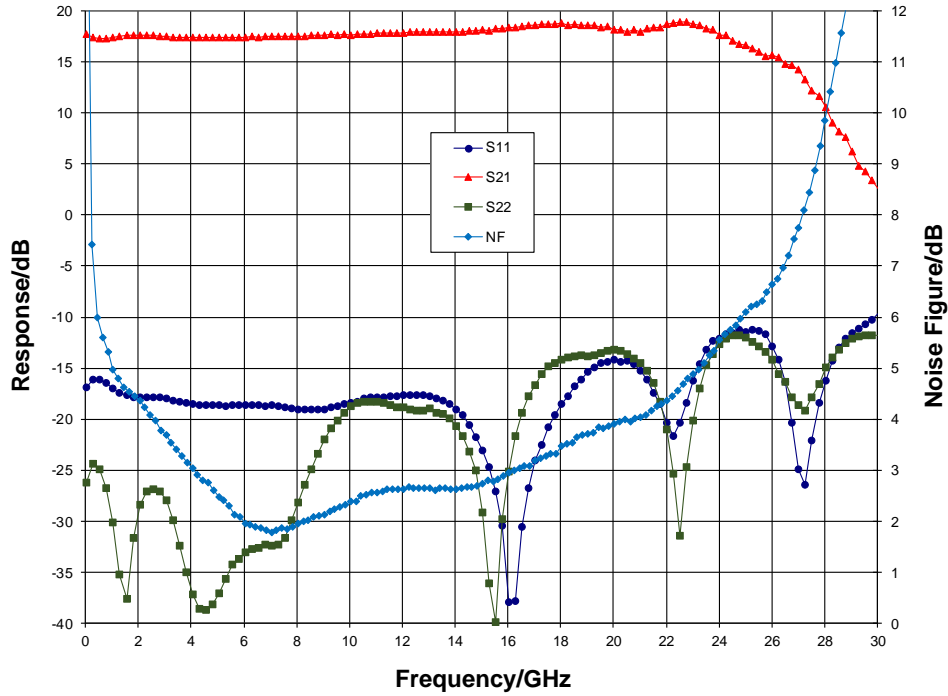

Narrow-band Performance,  $V_{dd} = 8.0 \text{ V}$ ,  $V_{gg} = -1.0 \text{ V}$ ,  $I_{dd} = 185 \text{ mA}$ ,  $T_A = 25 \text{ }^\circ\text{C}$

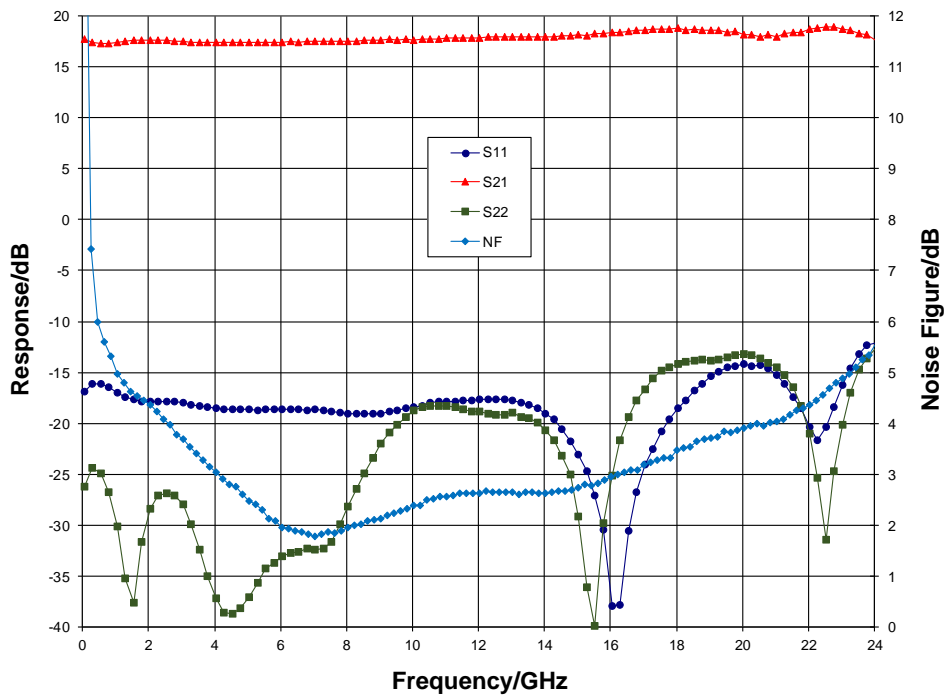

Typical Performance

Gain vs. Temperature,  $V_{dd} = 8.0\text{ V}$ ,  $V_{gg} = -1.0\text{ V}$

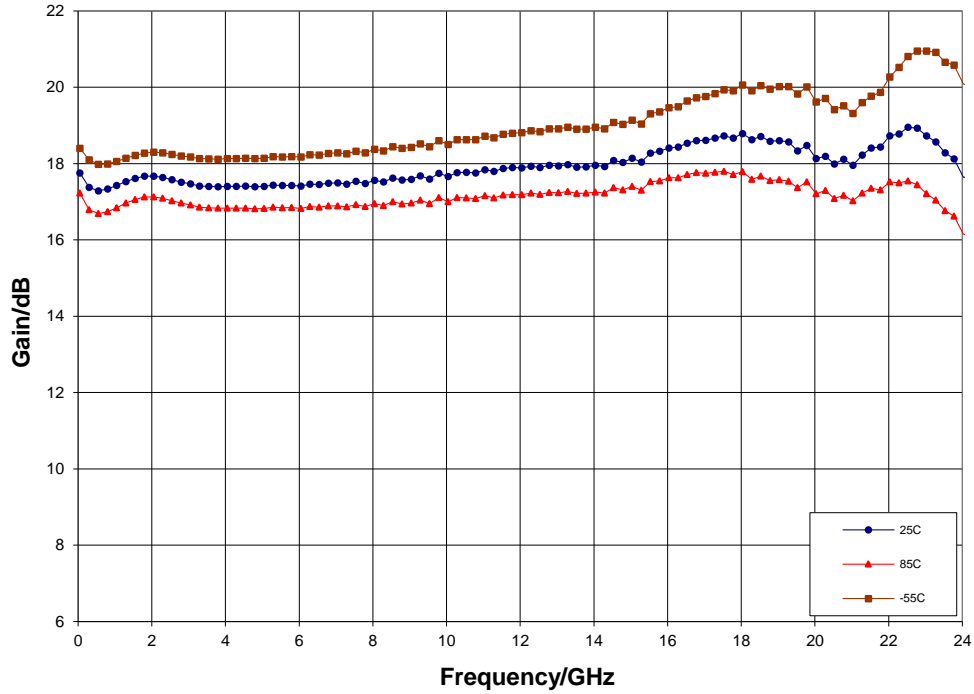

Gain vs. Supply Voltage,  $T_A = 25\text{ }^\circ\text{C}$

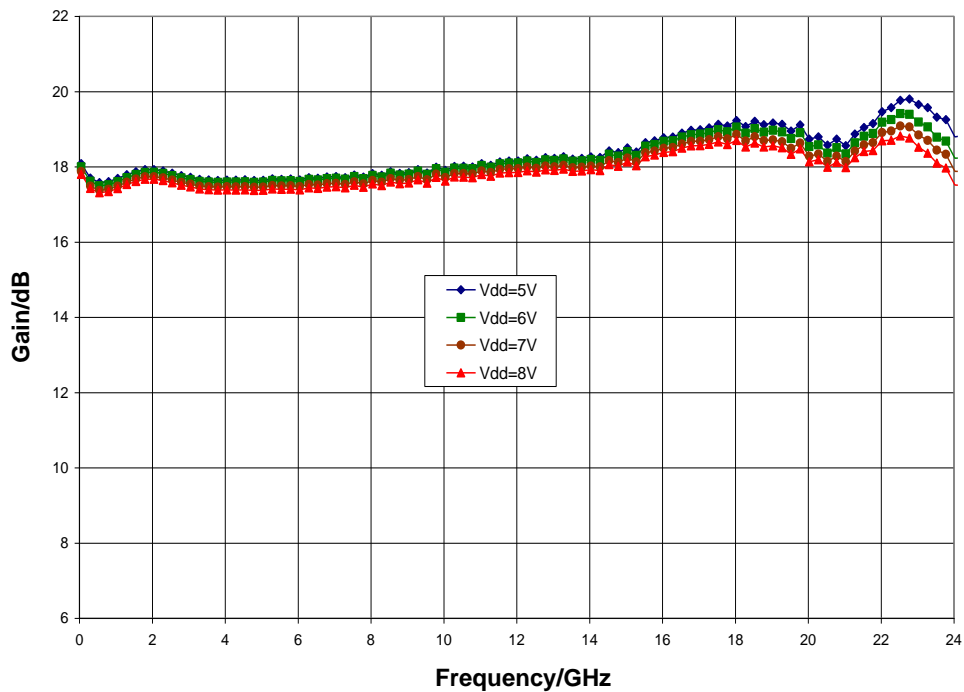

Typical Performance

Noise Figure vs. Temperature,  $V_{dd} = 8.0\text{ V}$ ,  $V_{gg} = -1.0\text{ V}$

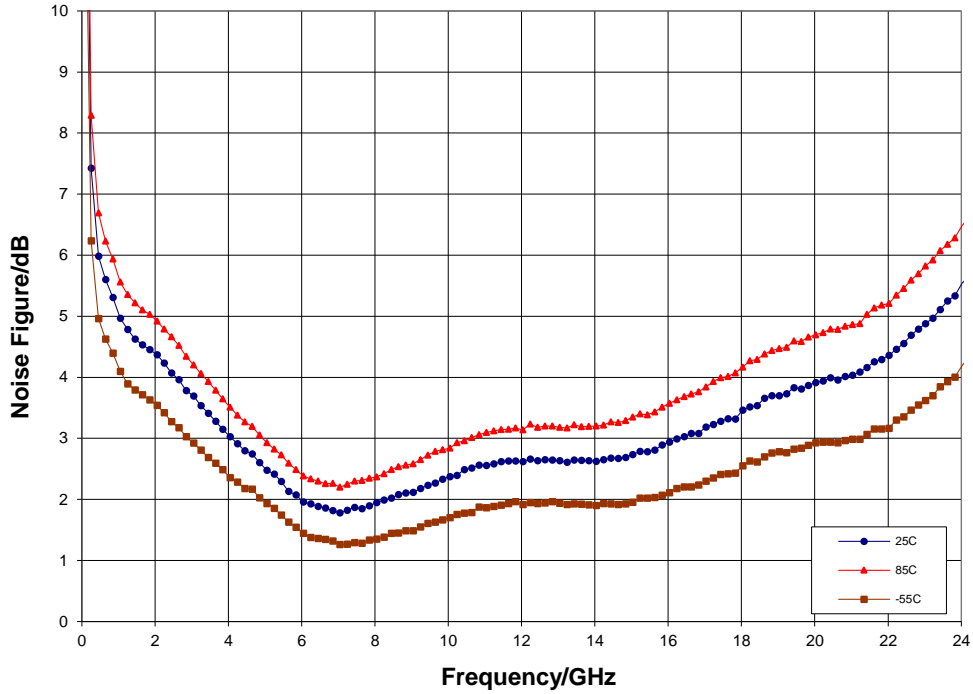

Noise Figure vs. Supply Voltage,  $T_A = 25\text{ }^\circ\text{C}$

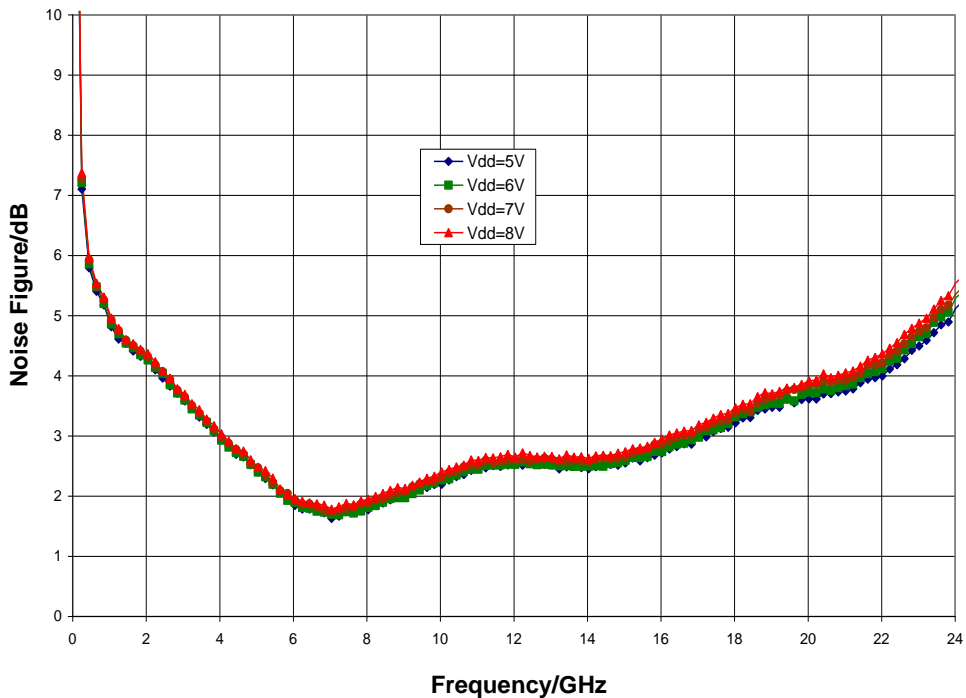

Typical Performance

Output Power,  $V_{dd} = 8.0\text{ V}$ ,  $V_{gg} = -1.0\text{ V}$ ,  $T_A = 25\text{ }^\circ\text{C}$

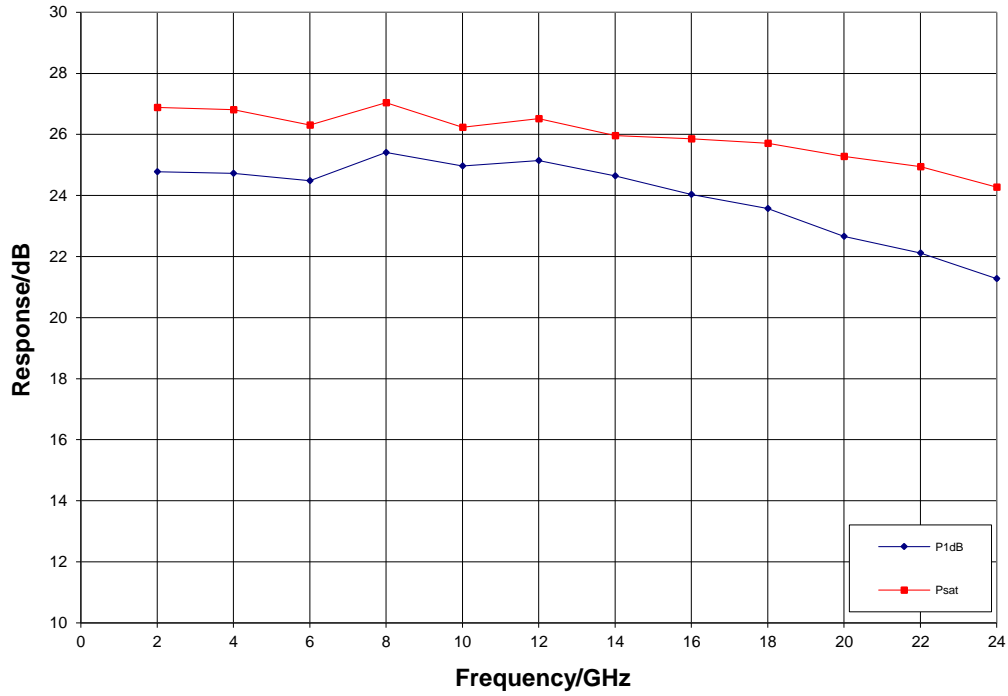

P1dB vs. Temperature,  $V_{dd} = 8.0\text{ V}$ ,  $V_{gg} = -1.0\text{ V}$

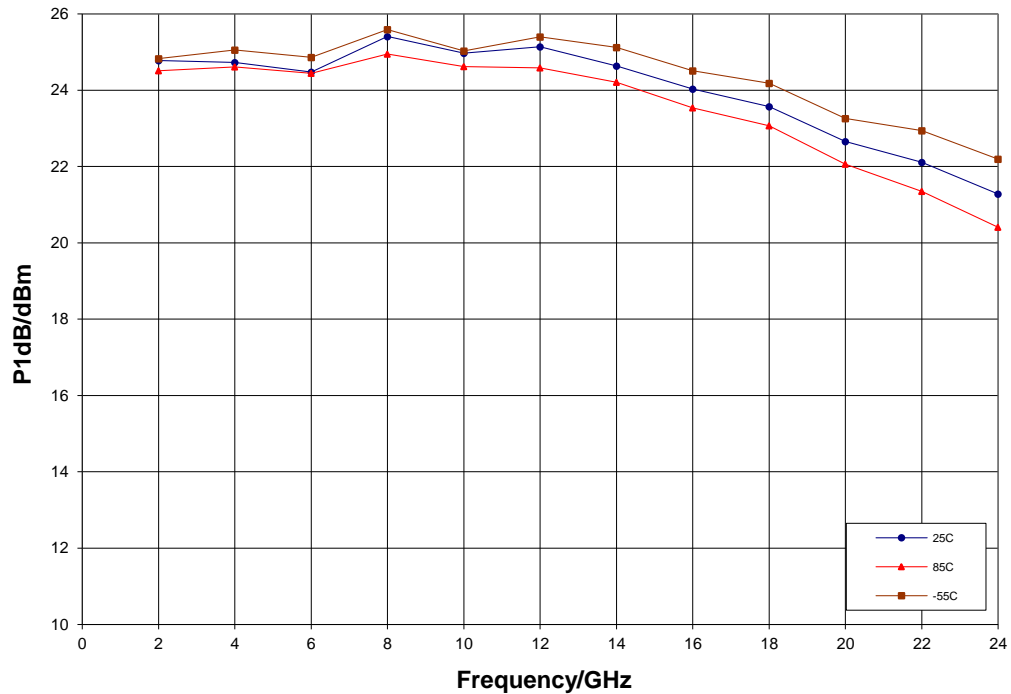

Typical Performance

P1dB vs. Supply Voltage, T<sub>A</sub> = 25 °C

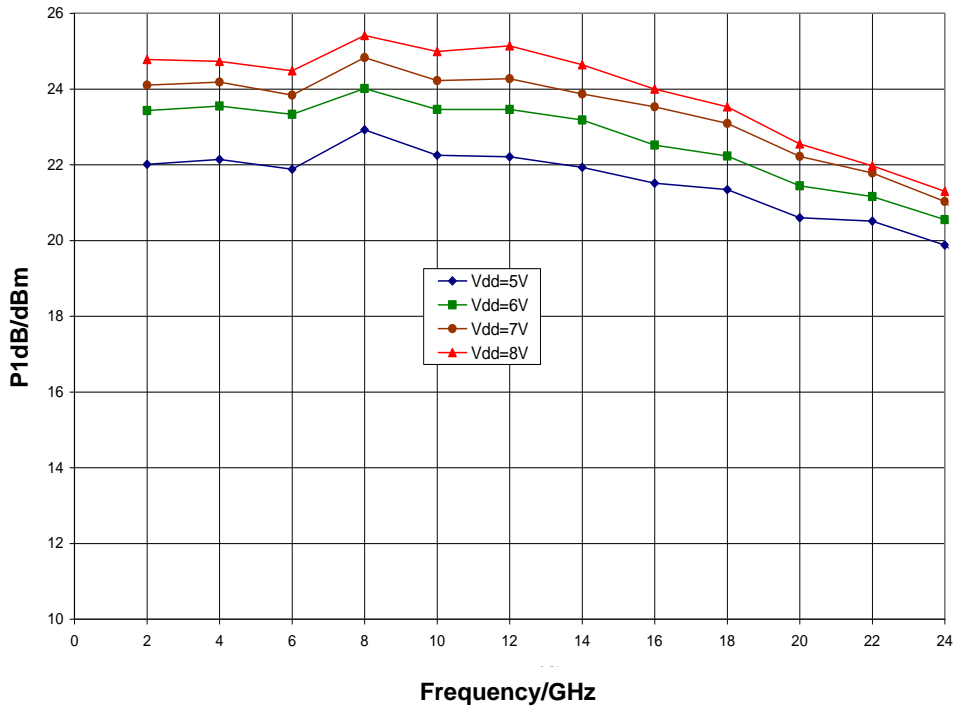

Typical Performance

Output IP3 vs. Temperature,  $V_{dd} = 8.0\text{ V}$ ,  $V_{gg} = -1.0\text{ V}$

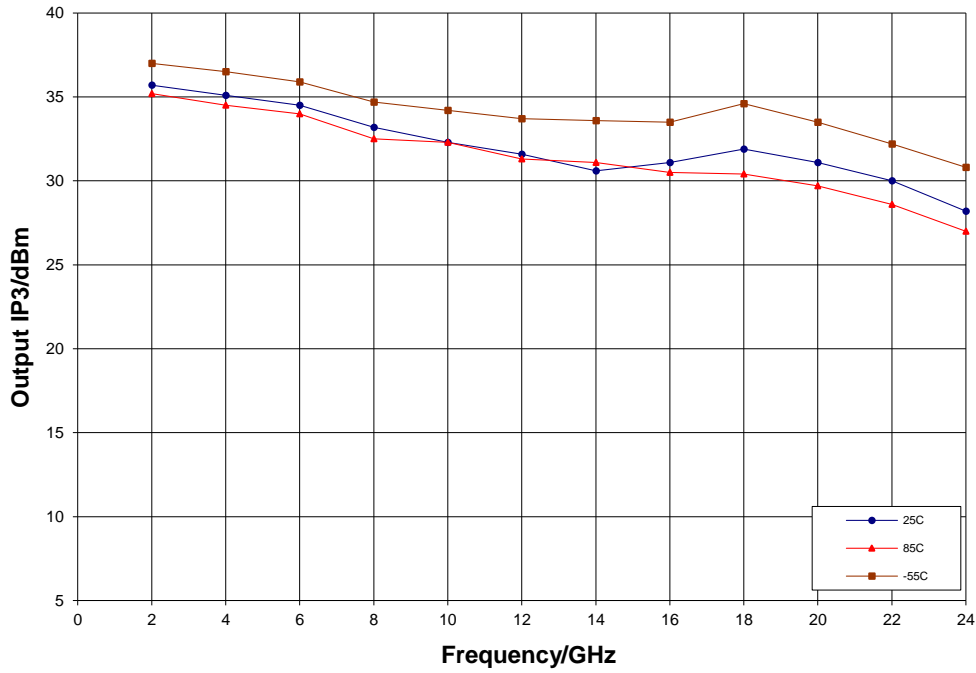

Output IP3 vs. Supply Voltage,  $T_A = 25\text{ °C}$

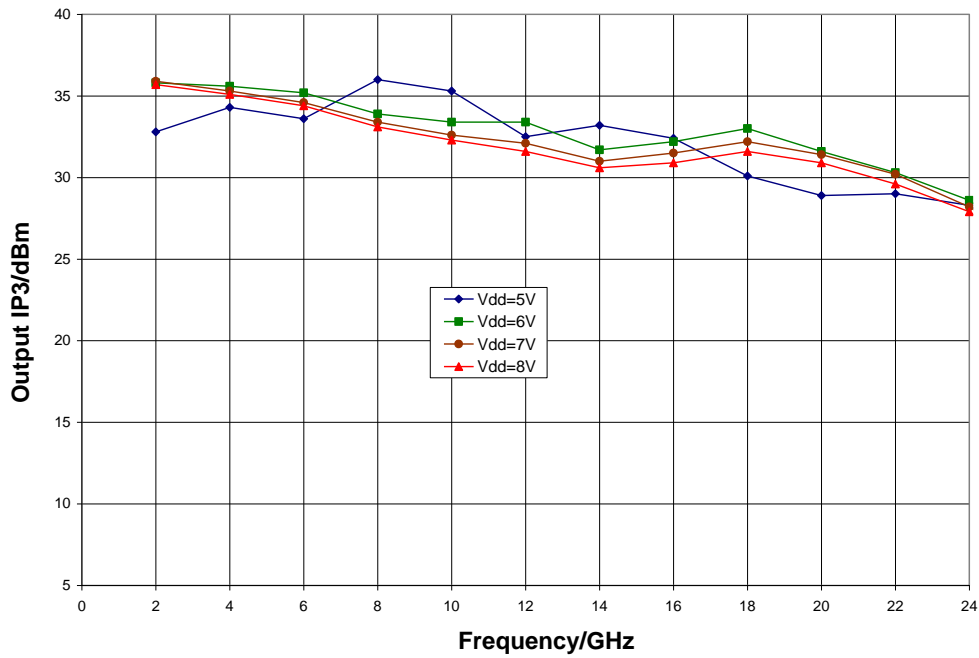



Mechanical Information

Die Outline (all dimensions in microns)

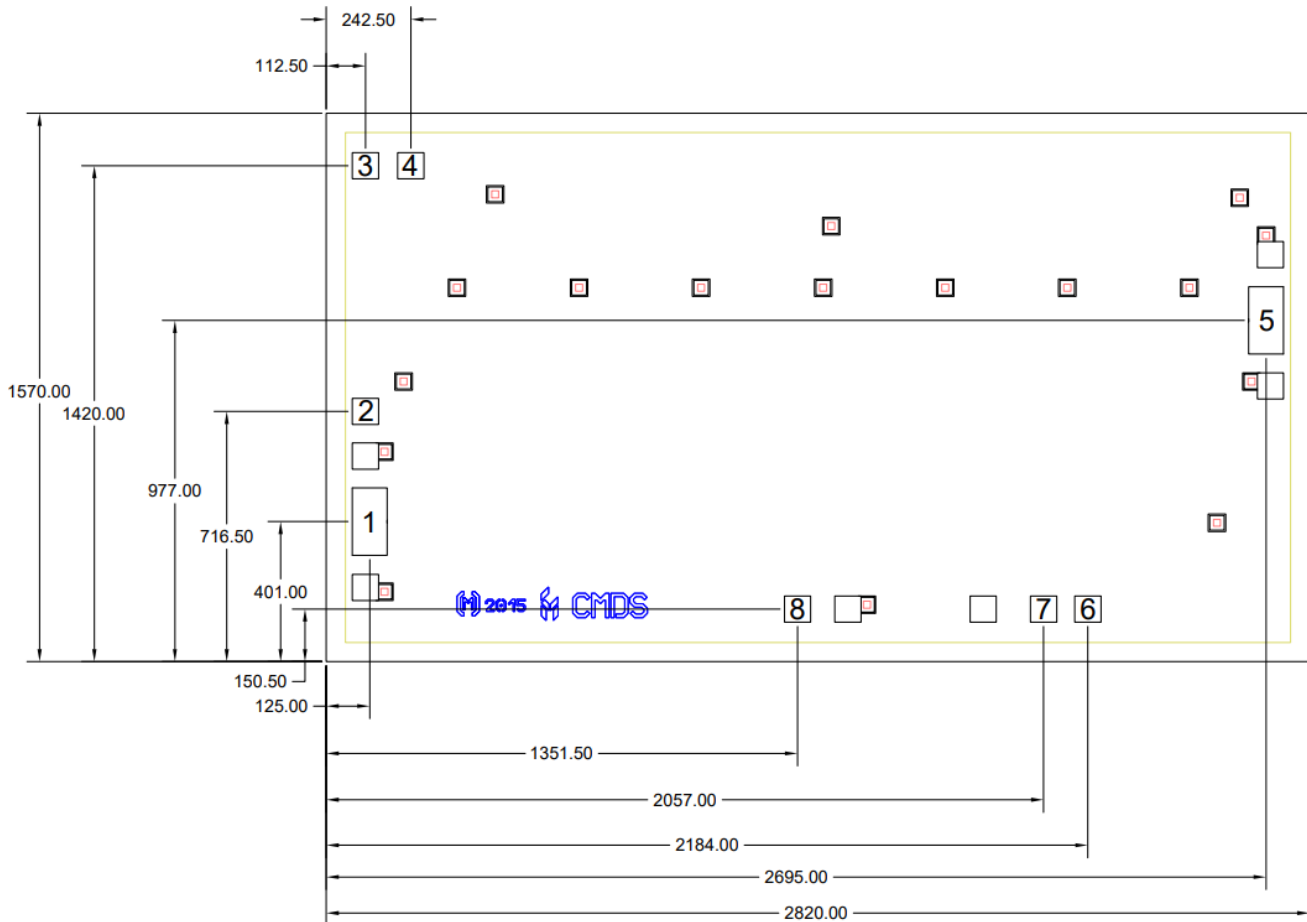

Notes:

1. No connection required for unlabeled pads
2. Backside is RF and DC ground
3. Backside and bond pad metal: Gold
4. Die is 70 microns thick
5. DC bond pads (2, 3, 4, 6, 7, 8) are 75 x 75 microns
6. RF bond pads (1, 5) are 100 x 193 microns

## Pad Description

### Pad Diagram



### Functional Description

Pad	Function	Description	Schematic
1	RF in	50 ohm matched input	
2	V <sub>gg2</sub>	Optional supply voltage for gain control Decoupling and bypass caps required Leave open if not in use	
3, 4	ACG1, 2	Low frequency termination Attach bypass capacitor per application circuit	
5	RF out & V <sub>dd</sub>	Power supply voltage and 50 ohm matched output	
6, 7	ACG3, 4	Low frequency termination. Attach bypass capacitor per application circuit	
8	V <sub>gg</sub>	Power supply voltage Decoupling and bypass caps required	
Backside	Ground	Connect to RF / DC ground	

**Applications Information**

**Assembly Guidelines**

The backside of the CMD244 is RF ground. Die attach should be accomplished with electrically and thermally conductive epoxy or eutectic attach. Standard assembly procedures should be followed for high frequency devices. The top surface of the semiconductor should be made planar to the adjacent RF transmission lines, and the RF decoupling capacitors placed in close proximity to the DC connections on chip.

RF connections should be made as short as possible to reduce the inductive effect of the bond wire. Use of a 0.8 mil thermosonic wedge bonding is highly recommended as the loop height will be minimized. The RF input and output require a double bond wire as shown.

The semiconductor is 70 um thick and should be handled by the sides of the die or with a custom collet. Do not make contact directly with the die surface as this will damage the monolithic circuitry. Handle with care.

**Assembly Diagram**

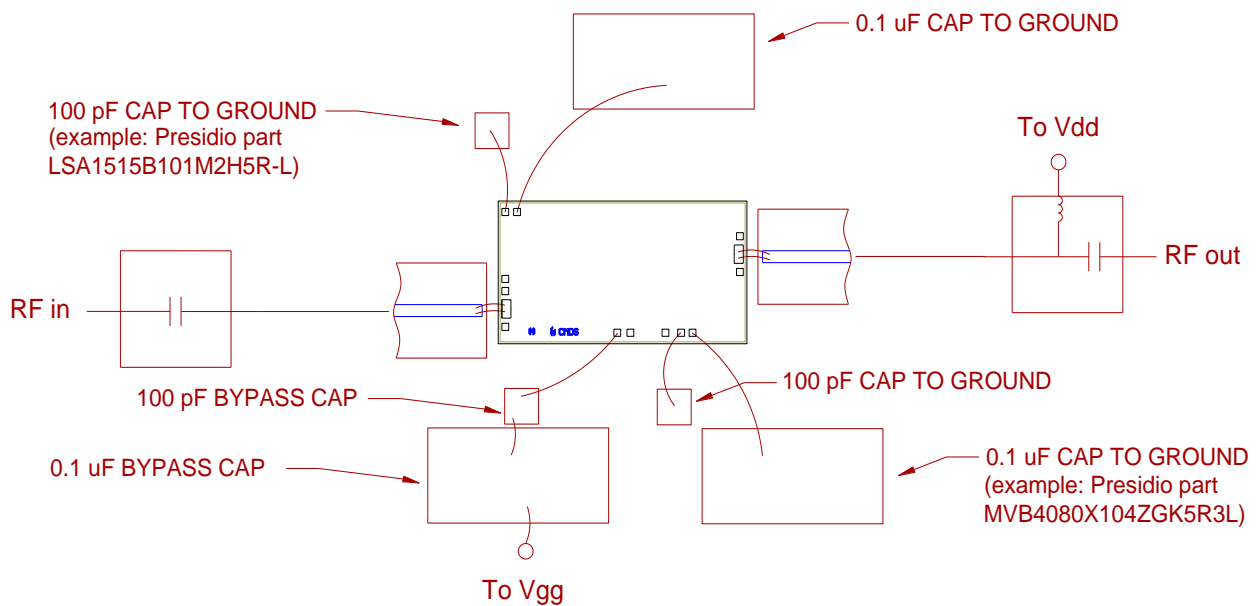

**GaAs MMIC devices are susceptible to damage from Electrostatic Discharge. Proper precautions should be observed during handling, assembly and test.**

## Applications Information

### Application Circuit

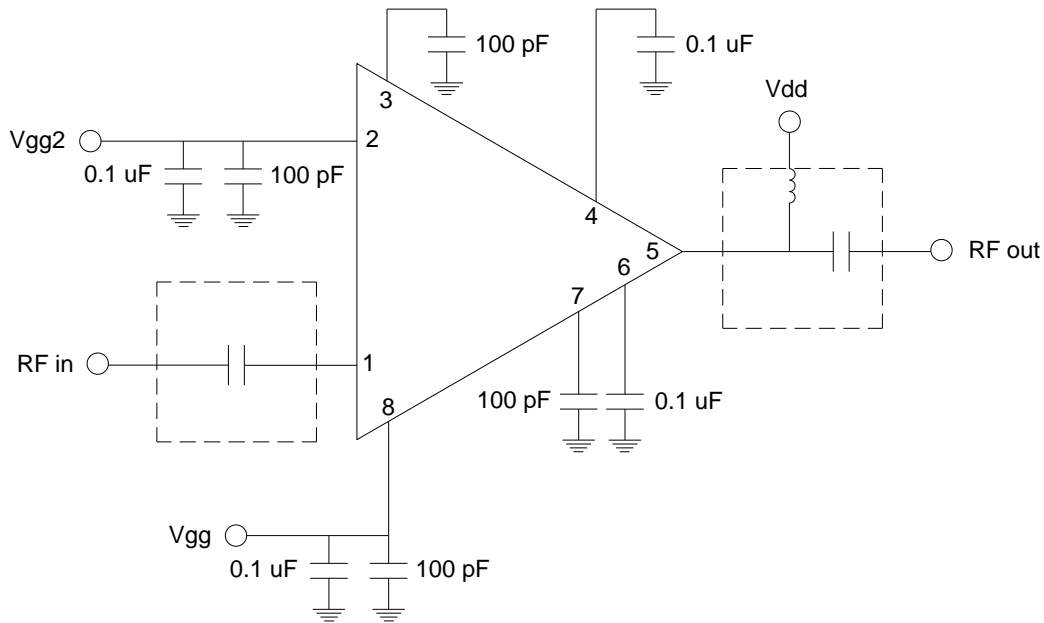

Note: Drain voltage ( $V_{dd}$ ) must be applied through a broadband bias tee or external bias network. External DC block is required on RF input.

### Biasing and Operation

The CMD244 is biased with a positive drain supply and a negative gate supply. Performance is optimized when the drain voltage is set to +8.0 V. The recommended voltage is -1.0 V.

Turn ON procedure:

1. Apply gate voltage  $V_{gg}$  and set to -1 V
2. Apply drain voltage  $V_{dd}$  and set to +8 V

Turn OFF procedure:

1. Turn off drain voltage  $V_{dd}$
2. Turn off gate voltage  $V_{gg}$

RF power can be applied at any time.

## Handling Precautions

Parameter	Rating	Standard
ESD – Human Body Model (HBM)	Class 1A	ESDA / JEDEC JS-001-2012



Caution!  
ESD-Sensitive Device

## RoHS Compliance

This part is compliant with 2011/65/EU RoHS directive (Restrictions on the Use of Certain Hazardous Substances in Electrical and Electronic Equipment) as amended by Directive 2015/863/EU.

This product also has the following attributes:

- Lead Free
- Antimony Free
- TBBP-A (C<sub>15</sub>H<sub>12</sub>Br<sub>4</sub>O<sub>2</sub>) Free
- SVHC Free
- Halogen Free
- PFOS Free

## Contact Information

For the latest specifications, additional product information, worldwide sales and distribution locations:

Web: [www.qorvo.com](http://www.qorvo.com)

Tel: 1-844-890-8163

Email: [customer.support@qorvo.com](mailto:customer.support@qorvo.com)

## Important Notice

The information contained in this Data Sheet and any associated documents (“Data Sheet Information”) is believed to be reliable; however, Qorvo makes no warranties regarding the Data Sheet Information and assumes no responsibility or liability whatsoever for the use of said information. All Data Sheet Information is subject to change without notice. Customers should obtain and verify the latest relevant Data Sheet Information before placing orders for Qorvo® products. Data Sheet Information or the use thereof does not grant, explicitly, implicitly or otherwise any rights or licenses to any third party with respect to patents or any other intellectual property whether with regard to such Data Sheet Information itself or anything described by such information.

DATA SHEET INFORMATION DOES NOT CONSTITUTE A WARRANTY WITH RESPECT TO THE PRODUCTS DESCRIBED HEREIN, AND QORVO HEREBY DISCLAIMS ANY AND ALL WARRANTIES WITH RESPECT TO SUCH PRODUCTS WHETHER EXPRESS OR IMPLIED BY LAW, COURSE OF DEALING, COURSE OF PERFORMANCE, USAGE OF TRADE OR OTHERWISE, INCLUDING THE IMPLIED WARRANTIES OF MERCHANTABILITY AND FITNESS FOR A PARTICULAR PURPOSE. Without limiting the generality of the foregoing, Qorvo® products are not warranted or authorized for use as critical components in medical, life-saving, or life-sustaining applications, or other applications where a failure would reasonably be expected to cause severe personal injury or death. Applications described in the Data Sheet Information are for illustrative purposes only. Customers are responsible for validating that a particular product described in the Data Sheet Information is suitable for use in a particular application.

© 2022 Qorvo US, Inc. All rights reserved. This document is subject to copyright laws in various jurisdictions worldwide and may not be reproduced or distributed, in whole or in part, without the express written consent of Qorvo US, Inc. | QORVO® is a registered trademark of Qorvo US, Inc.