



# TGA2621-SM

## 16–18.5 GHz 1 W GaAs Power Amplifier

### General Description

Qorvo's TGA2621-SM is a packaged Ku-band Power Amplifier fabricated on Qorvo's TQPHT15 0.15  $\mu\text{m}$  GaAs pHEMT process. The TGA2621-SM operates from 16 to 18.5 GHz and typically provides greater than 1 W of saturated output power with greater than 23% PAE and greater than 24.5 dB of small signal gain.

The TGA2621-SM is available in a low cost, surface mount 32 lead 5x5 mm air-cavity ceramic QFN. It is ideally suited to support both radar and satellite communications as a driver or low power amplifier.

Both RF ports have integrated DC blocking caps and are fully matched to 50 ohms allowing for simple system integration.

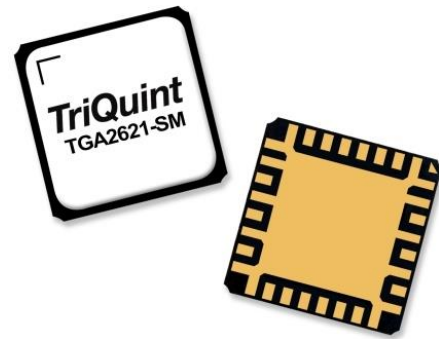

### Functional Block Diagram

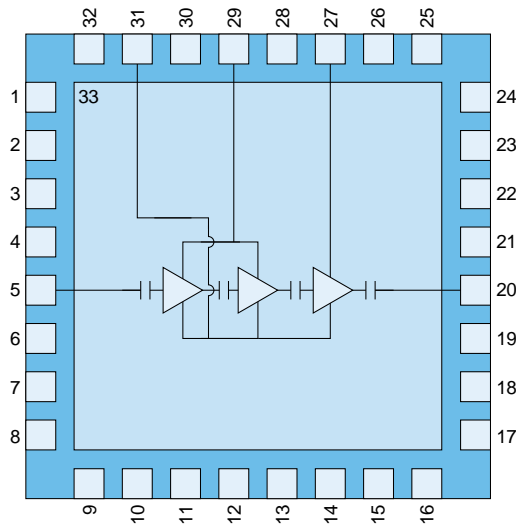

### Applications

- Commercial and Military Radar
- Satellite Communications

### Product Features

- Frequency Range: 16–18.5 GHz
- P<sub>SAT</sub>: >30 dBm at Pin = 10 dBm
- PAE: >23 % at Pin = 10 dBm
- Small Signal Gain: >24.5 dB
- Input Return Loss: >10 dB
- Bias: V<sub>D</sub> = 6 V, I<sub>DQ</sub> = 500 mA, V<sub>G</sub> = -0.6 V Typical
- Package Dimensions: 5.0 x 5.0 x 1.45 mm

### Pad Configuration

Pad no.	Symbol
1, 2, 4, 6, 8-9, 16-17, 19, 21, 23-25, 32-33	Gnd
3, 7, 10-15, 18, 22, 26, 28, 30	N/C
5	RF <sub>IN</sub>
20	RF <sub>OUT</sub>
27	V <sub>D2</sub>
29	V <sub>D1</sub>
31	V <sub>G</sub>

### Ordering Information

Part	Description
TGA2621-SM	16–18.5 GHz 1 W GaAs Power Amplifier

## Absolute Maximum Ratings

Parameter	Value/Range
Drain Voltage ( $V_D$ )	6.25 V
Gate Voltage Range ( $V_G$ )	-2 to 0 V
Drain Current ( $I_D$ )	1300 mA
Gate Current ( $I_G$ )	-5 to 5 mA
Power Dissipation, CW, 85 °C ( $P_{DISS}$ )	3.0 W
Input Power, CW, 85 °C, 50 $\Omega$ , ( $P_{IN}$ )	17 dBm
Input Power, CW, 85 °C, (3:1 $V_{SWR}$ ), ( $P_{IN}$ )	17 dBm
Channel temperature ( $T_{CH}$ )	200 °C
Mounting Temperature (30 Seconds)	260 °C
Storage Temperature	-55 to 150 °C

Operation of this device outside the parameter ranges given above may cause permanent damage. These are stress ratings only, and functional operation of the device at these conditions is not implied.

## Recommended Operating Conditions

Parameter	Value/Range
Drain Voltage ( $V_D$ )	6 V
Drain Current ( $I_{DQ}$ )	500 mA
Gate Voltage ( $V_G$ )	-0.6 V Typical
Temperature ( $T_{BASE}$ )	-40 to 85 °C

Electrical specifications are measured at specified test conditions. Specifications are not guaranteed overall operating conditions.

## Electrical Specifications

Test conditions unless otherwise noted: 25 °C,  $V_D = 6$  V,  $I_{DQ} = 500$  mA,  $V_G = -0.6$  V typical, CW

Parameter	Min	Typical	Max	Units
Operational Frequency Range	16		18.5	GHz
Small Signal Gain		>24.5		dB
Input Return Loss		>10		dB
Output Return Loss		6		dB
Output Power ( $P_{in} = 10$ dBm)		>30		dBm
Power Added Efficiency ( $P_{in} = 10$ dBm)		>23		%
Small Signal Gain Temperature Coefficient		-0.036		dB/°C
Output Power Temperature Coefficient		-0.02		dB/°C

**Typical Performance, Small Signal**

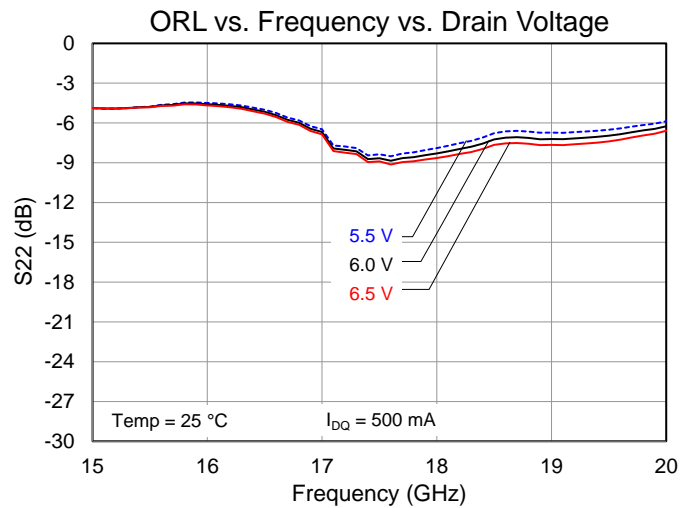
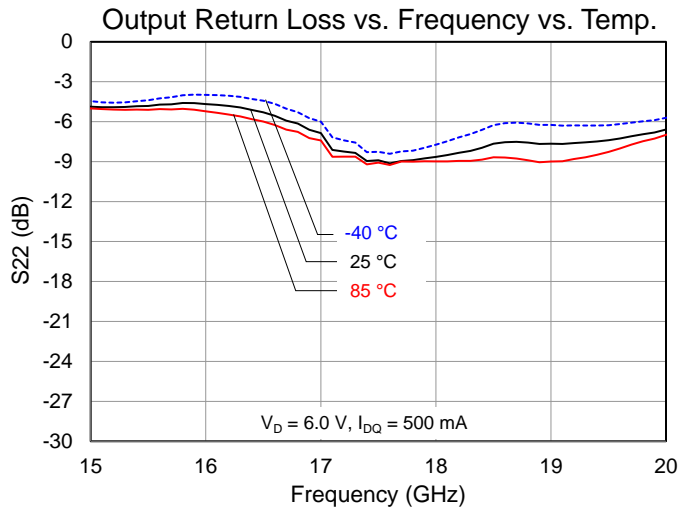
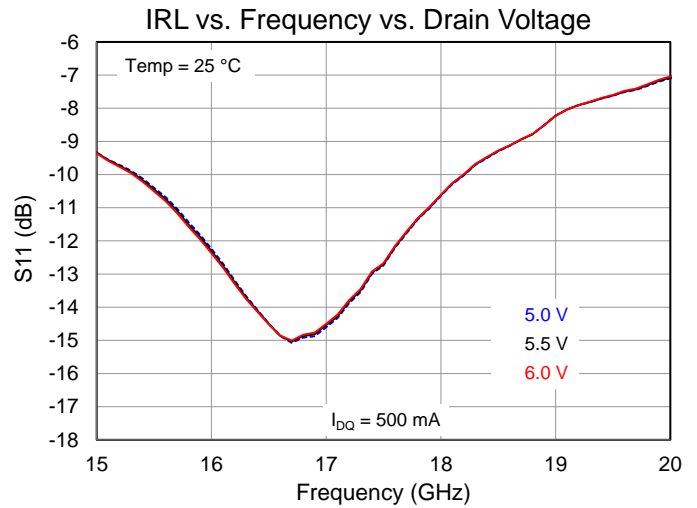
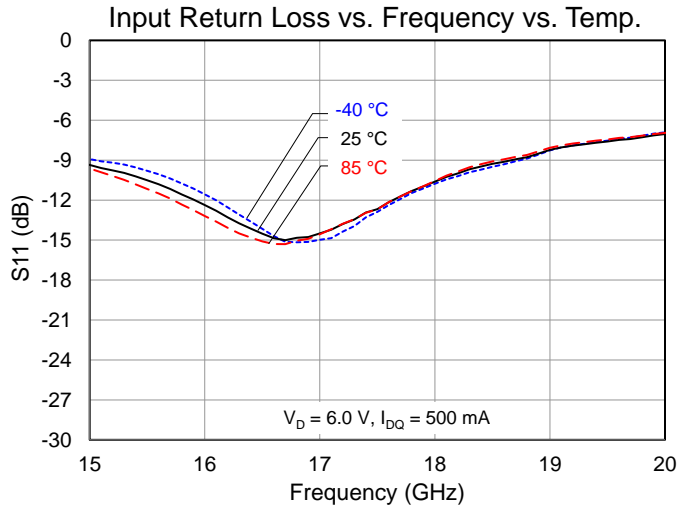
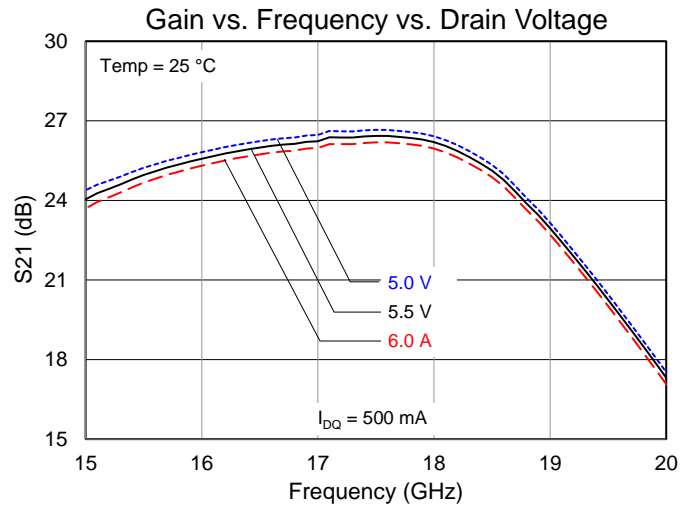
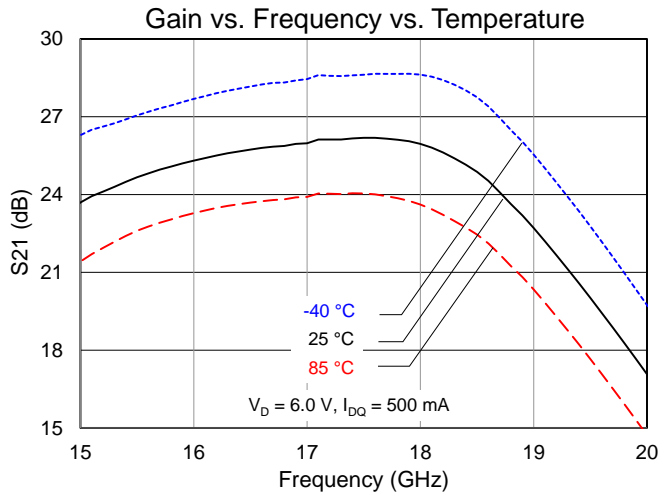

Typical Performance, Large Signal

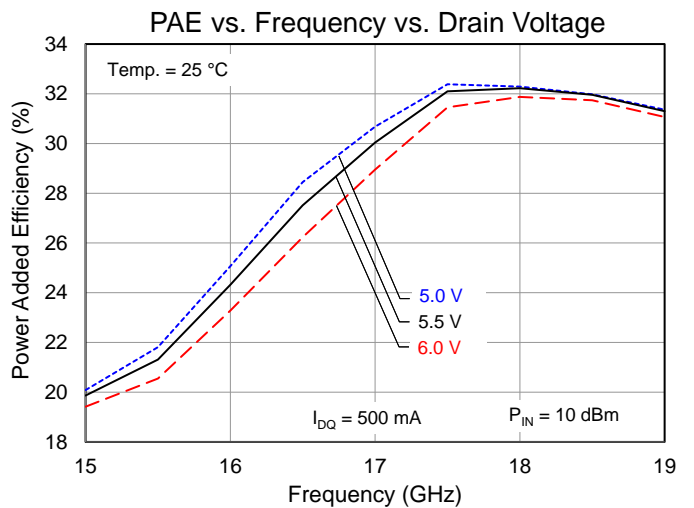
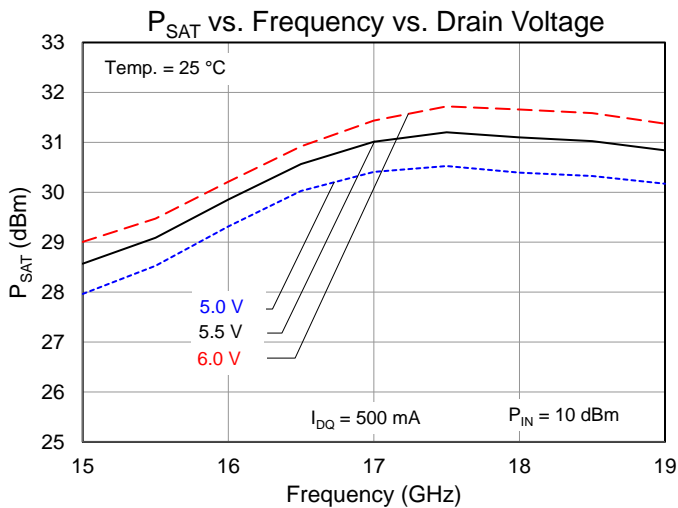
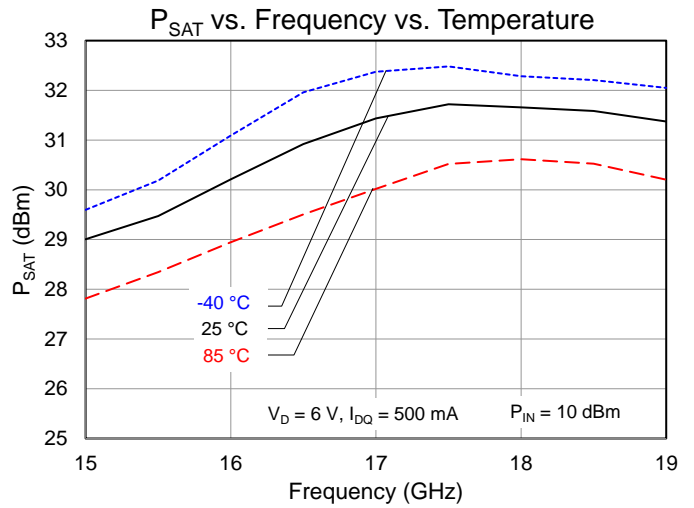
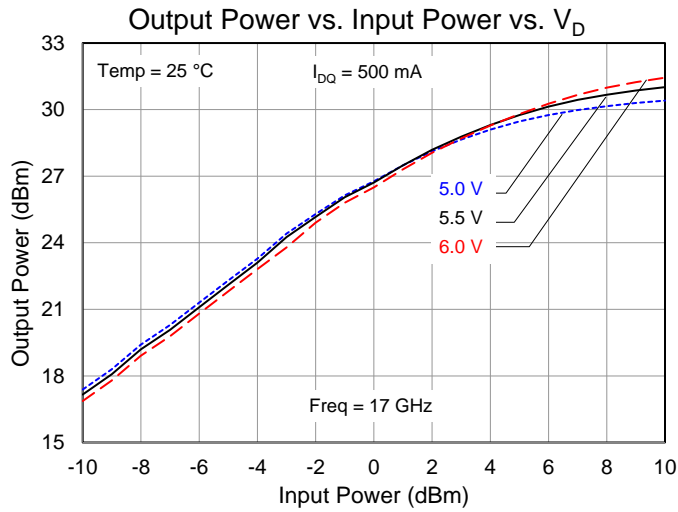
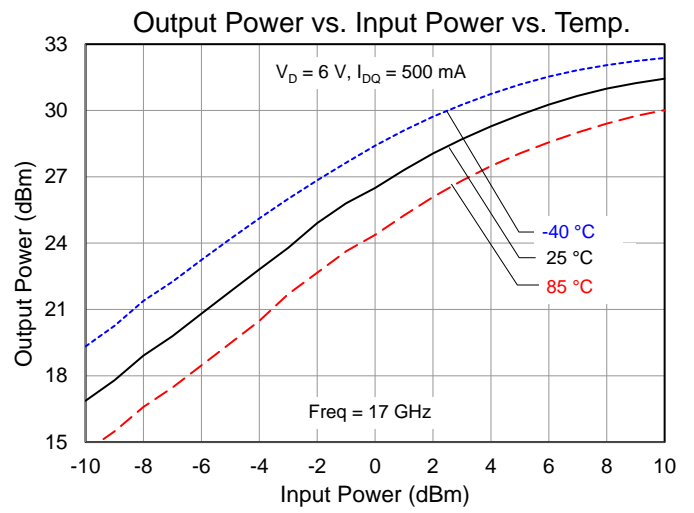
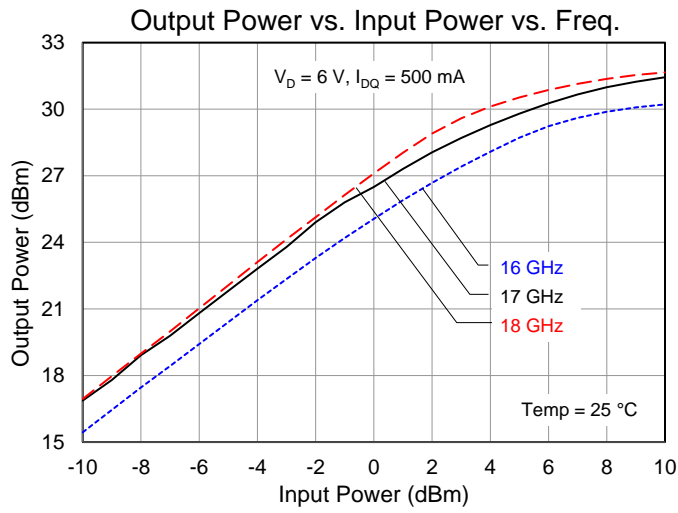

Typical Performance, Large Signal

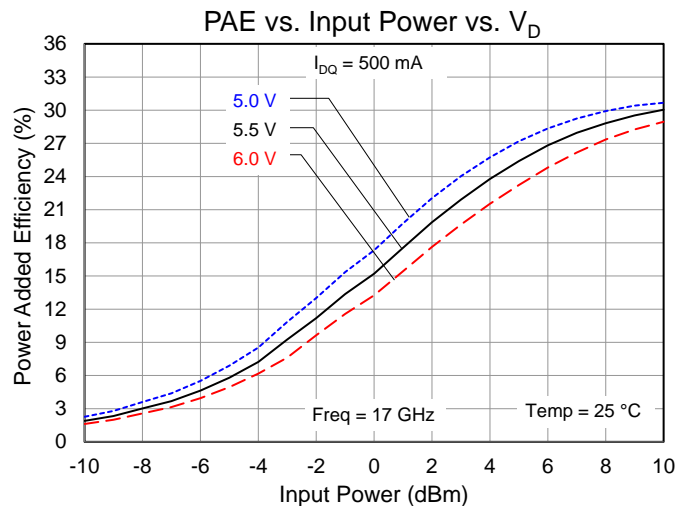
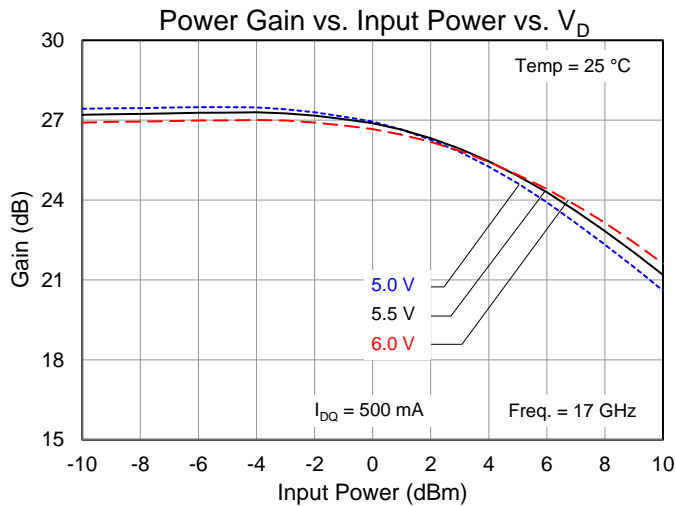
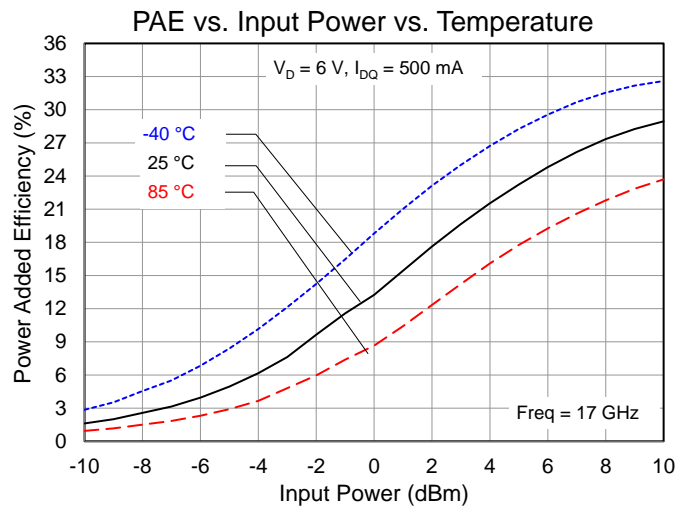
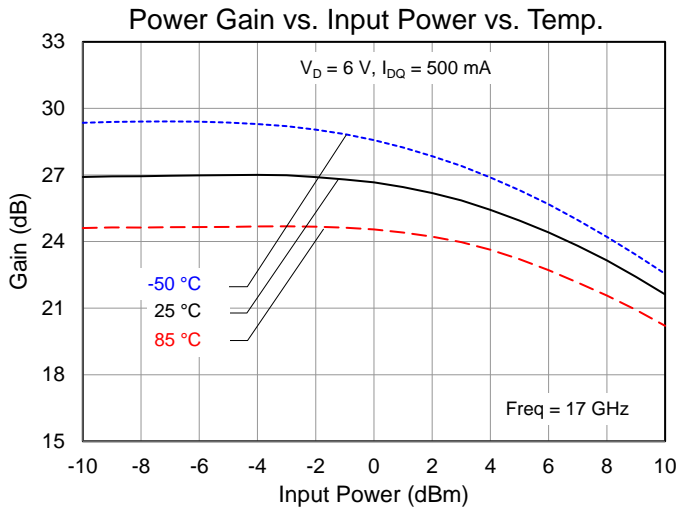
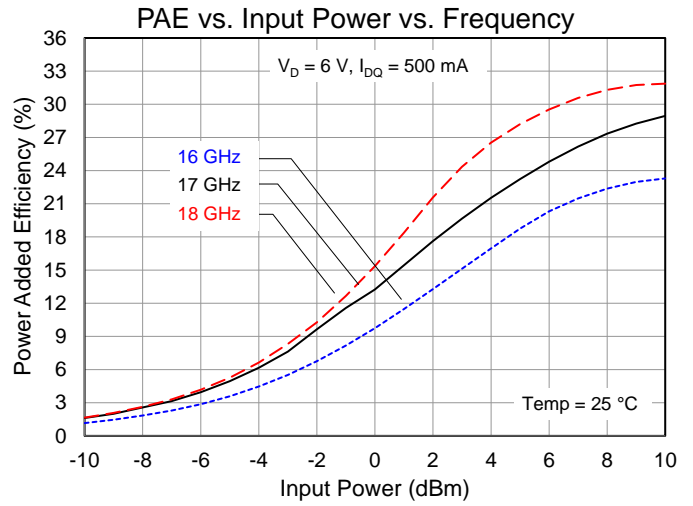
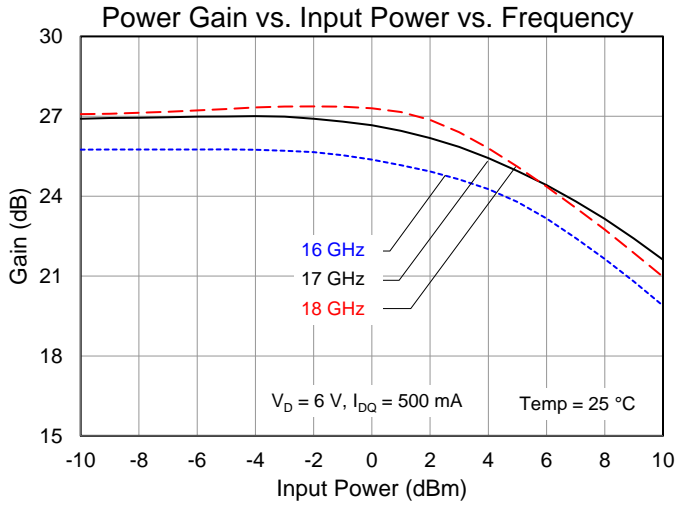

Typical Performance: (Large Signal)

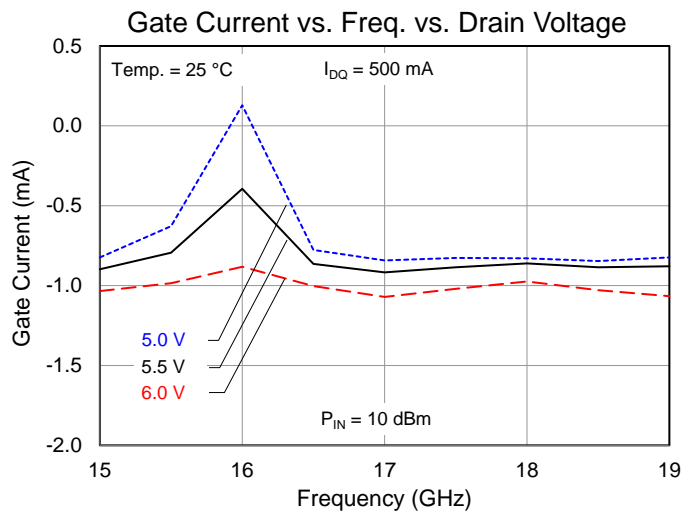
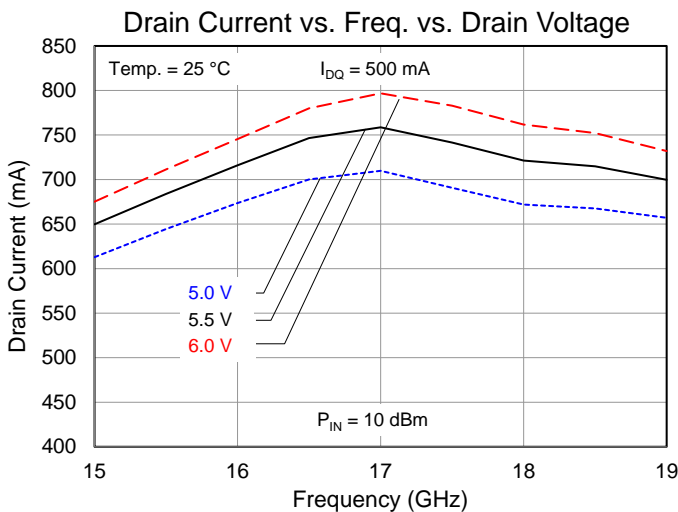
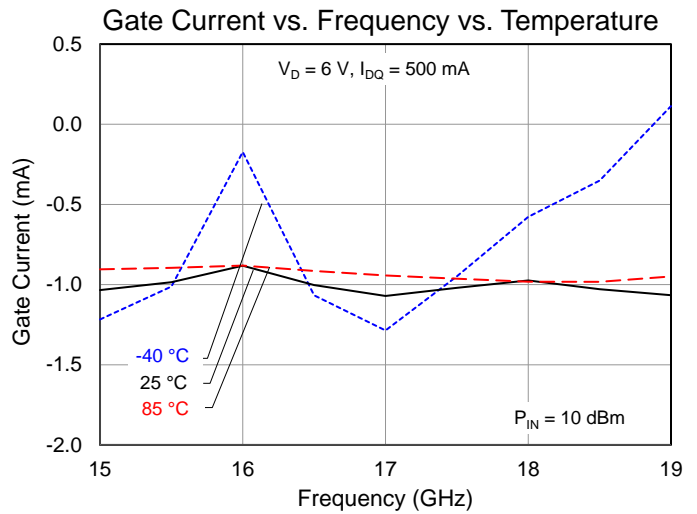
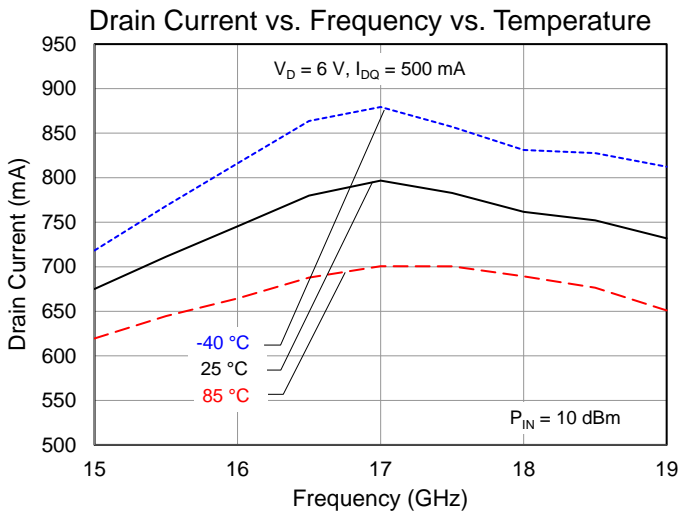
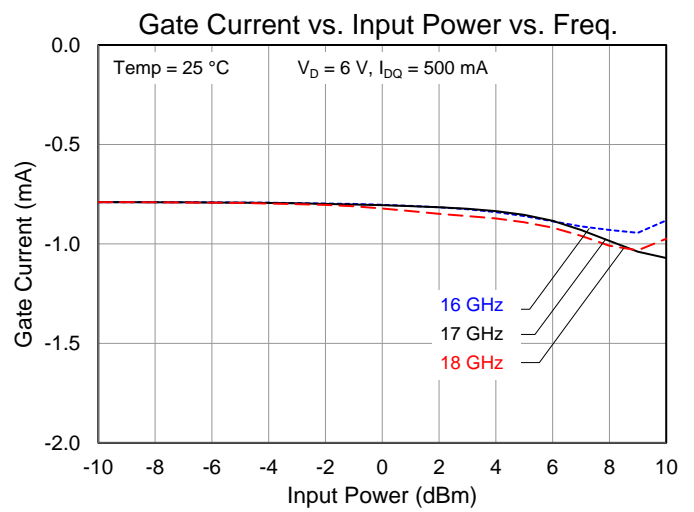
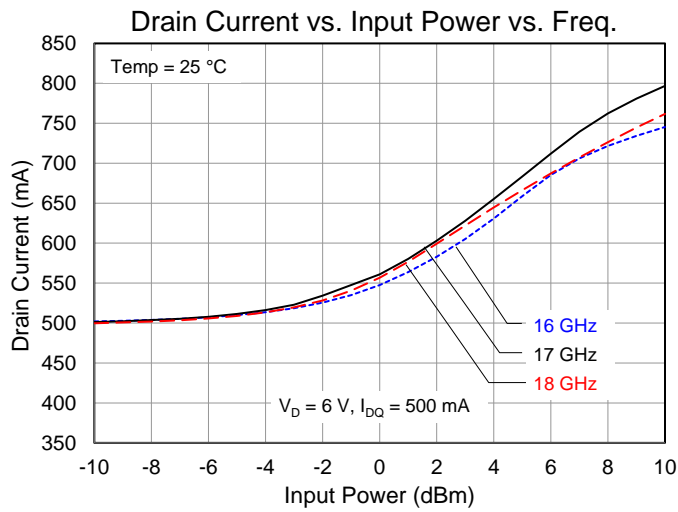

Typical Performance: Linearity

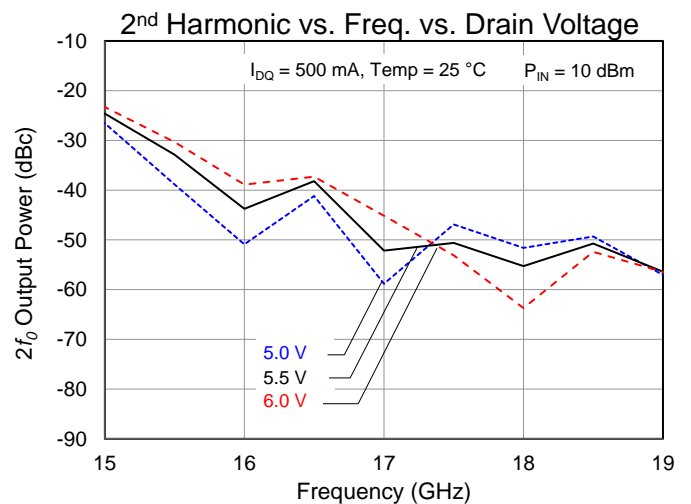
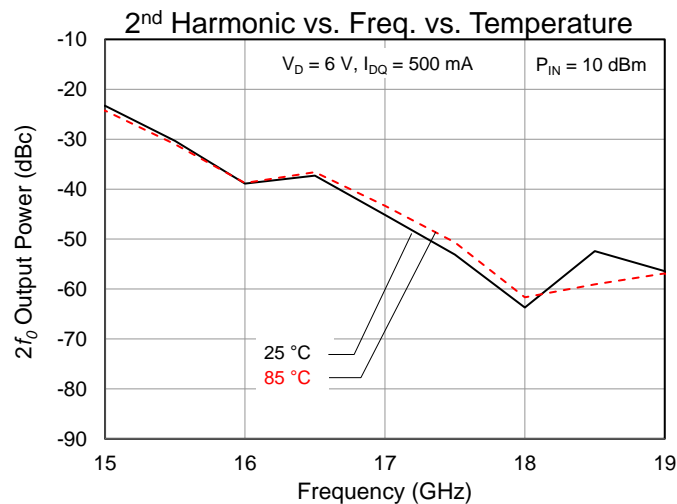
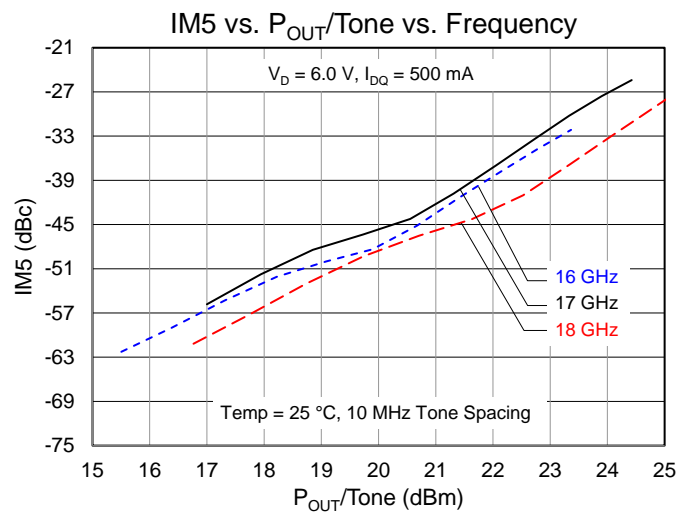
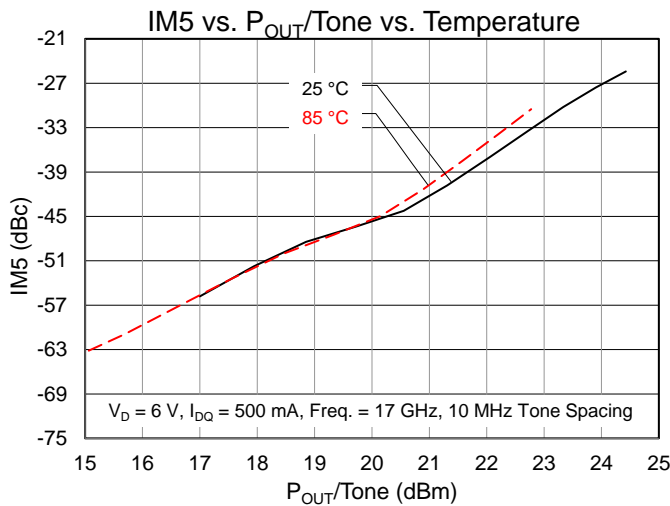
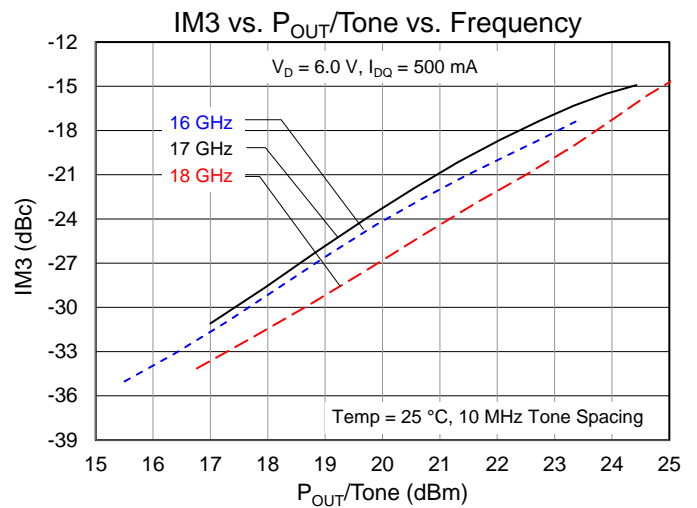
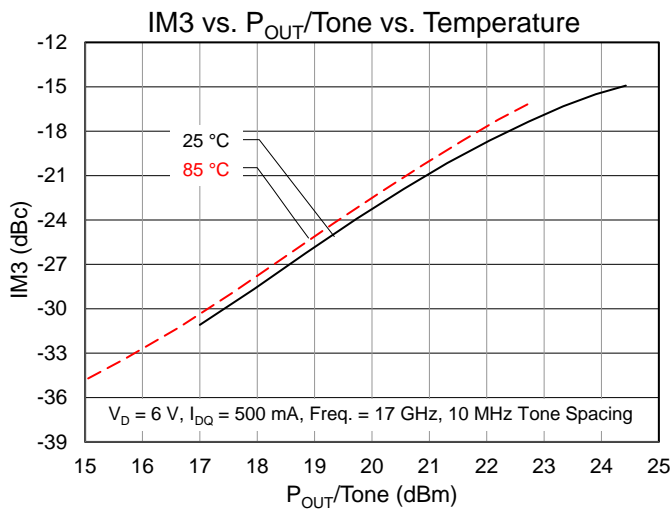

## Thermal and Reliability Information

Parameter	Test Conditions	Value	Units
Thermal Resistance ( $\theta_{JC}$ ) <sup>(1)</sup>	$T_{BASE} = 85\text{ }^{\circ}\text{C}$ , $V_D = 5\text{ V}$	22.28	$^{\circ}\text{C/W}$
Channel Temperature ( $T_{CH}$ ) (Under RF drive)	$I_{DQ} = 500\text{ mA}$ , $I_{D\_Drive} = 644\text{ mA}$ $P_{IN} = 10\text{ dBm}$ , $P_{OUT} = 28.9\text{ dBm}$ , $Freq = 16.5\text{ GHz}$ , $P_{DISS} = 2.46\text{ W}$	140	$^{\circ}\text{C}$
Median Lifetime ( $T_M$ )		$3.2 \times 10^6$	Hrs
Thermal Resistance ( $\theta_{JC}$ ) <sup>(1)</sup>	$T_{BASE} = 85\text{ }^{\circ}\text{C}$ , $V_D = 5.5\text{ V}$	22.72	$^{\circ}\text{C/W}$
Channel Temperature ( $T_{CH}$ ) (Under RF drive)	$I_{DQ} = 500\text{ mA}$ , $I_{D\_Drive} = 665\text{ mA}$ $P_{IN} = 10\text{ dBm}$ , $P_{OUT} = 29.2\text{ dBm}$ , $Freq = 16.5\text{ GHz}$ , $P_{DISS} = 2.83\text{ W}$	149	$^{\circ}\text{C}$
Median Lifetime ( $T_M$ )		$1.2 \times 10^6$	Hrs
Thermal Resistance ( $\theta_{JC}$ ) <sup>(1)</sup>	$T_{BASE} = 85\text{ }^{\circ}\text{C}$ , $V_D = 6\text{ V}$	23.14	$^{\circ}\text{C/W}$
Channel Temperature ( $T_{CH}$ ) (Under RF drive)	$I_{DQ} = 500\text{ mA}$ , $I_{D\_Drive} = 780\text{ mA}$ $P_{IN} = 10\text{ dBm}$ , $P_{OUT} = 29.5\text{ dBm}$ , $Freq = 16.5\text{ GHz}$ , $P_{DISS} = 3.24\text{ W}$	160	$^{\circ}\text{C}$
Median Lifetime ( $T_M$ )		$3.5 \times 10^5$	Hrs

Notes:

- Resistance measured at back of the package.

Conditions:  $V_D = 6\text{ V}$ ; Failure Criteria is 10% reduction in  $I_{D\_MAX}$

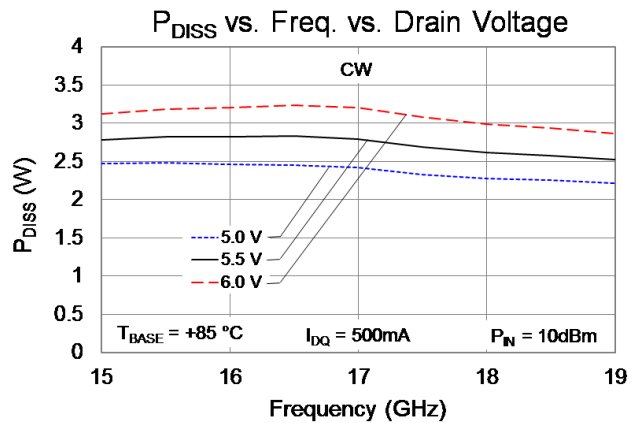
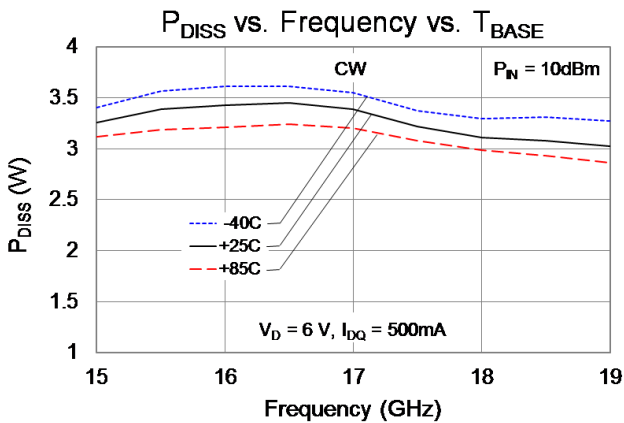
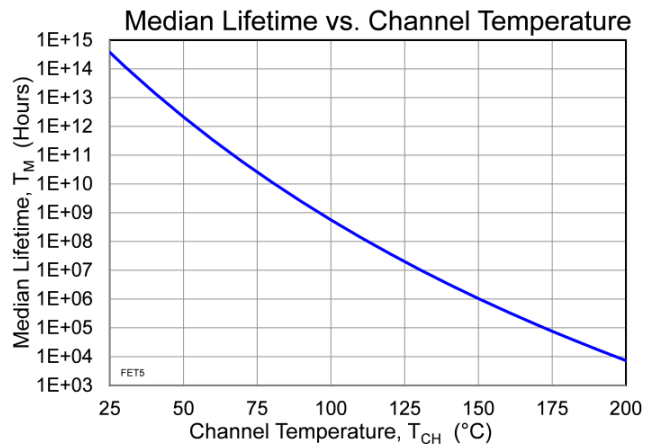
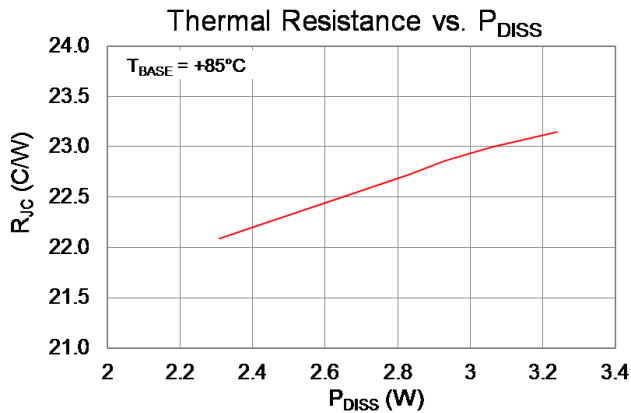



## Application Information

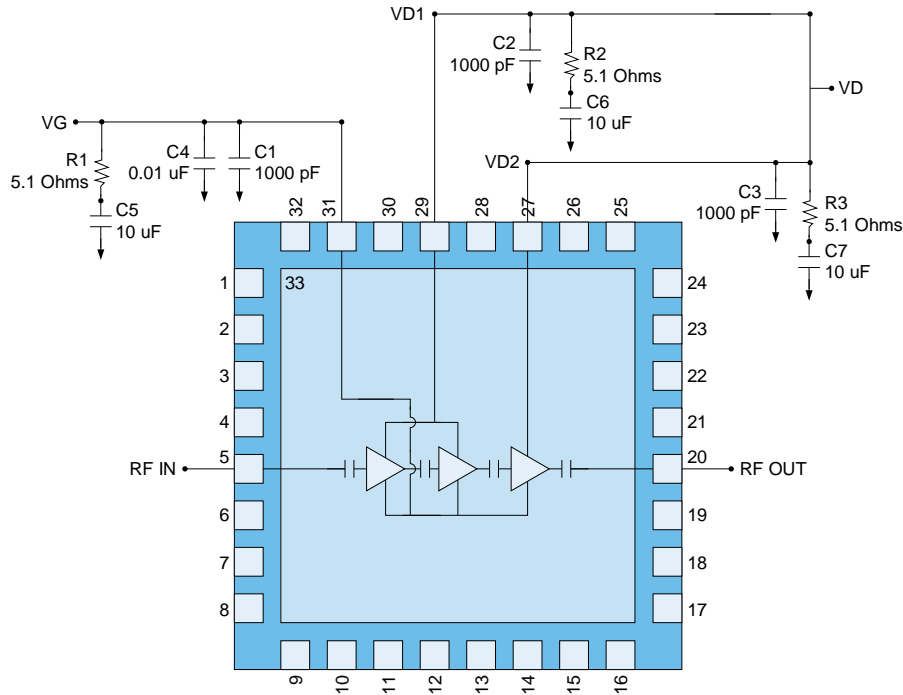

### Bias-up Procedure

- Set  $I_D$  limit to 1000 mA,  $I_G$  limit to 4 mA
- Apply -2 V to  $V_G$  for pinch off
- Apply +6 V to  $V_D$
- Adjust  $V_G$  more positive until  $I_{DQ} = 500$  mA ( $V_G \sim -0.6$  V Typical)
- Apply RF signal

### Bias-down Procedure

- Turn off RF signal
- Reduce  $V_G$  to -2 V. Ensure  $I_{DQ} \sim 0$  mA
- Set  $V_D$  to 0 V
- Turn off  $V_D$  supply
- Turn off  $V_G$  supply

## Pin Description

Pin No.	Symbol	Description
1, 2, 4, 6, 8-9, 16-17, 19, 21, 23-25, 32	$G_{ND}$	Recommend grounding on PCB
3, 7, 10-15, 18, 22, 26, 28, 30	N/C	No Internal Connection
5	$RF_{IN}$	Input; matched to 50 $\Omega$ ; DC blocked
20	$RF_{OUT}$	Output; matched to 50 $\Omega$ ; DC blocked
27, 29	$V_{D1}, V_{D2}$	Drain voltage; bias network is required; see recommended Application Information above.
31	$V_G$	Gate voltage; bias network is required; see recommended Application Information above.
33	$G_{ND}$	Ground Paddle. Multiple vias should be employed to minimize inductance and thermal resistance.

Evaluation Board and Assembly

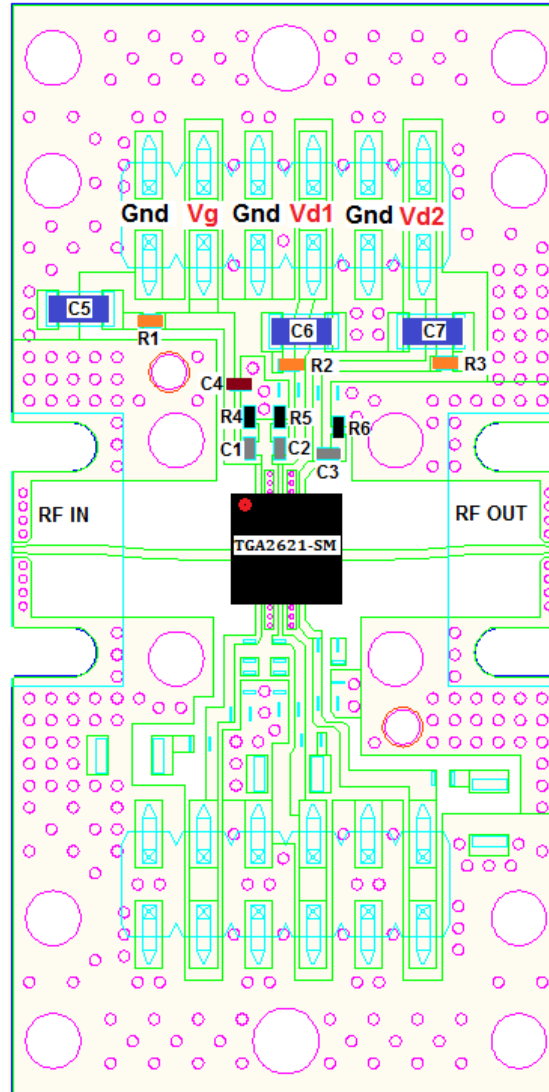

RF Layer is 0.008” thick Rogers Corp. RO4003C ( $\epsilon_r = 3.35$ ). Metal layers are 0.5 oz. copper. The microstrip line at the connector interface is optimized for the Southwest Microwave end launch connector 1092-01A-5.

Bill of Materials

Ref. Des.	Value	Description	Manuf.	Part Number
C1 – C3	1000 pF	Cap, 0402, X7R	Various	
C4	0.01 uF	Cap, 0402, X7R	Various	
C5 – C7	10 $\mu$ F	Cap, 1206, X5R	Various	
R1 – R3	5.1 Ohms	Res, 0402	Various	
R4 – R6	0 Ohms	Res, 0402 (Jumper, required)	Various	

Mechanical Information

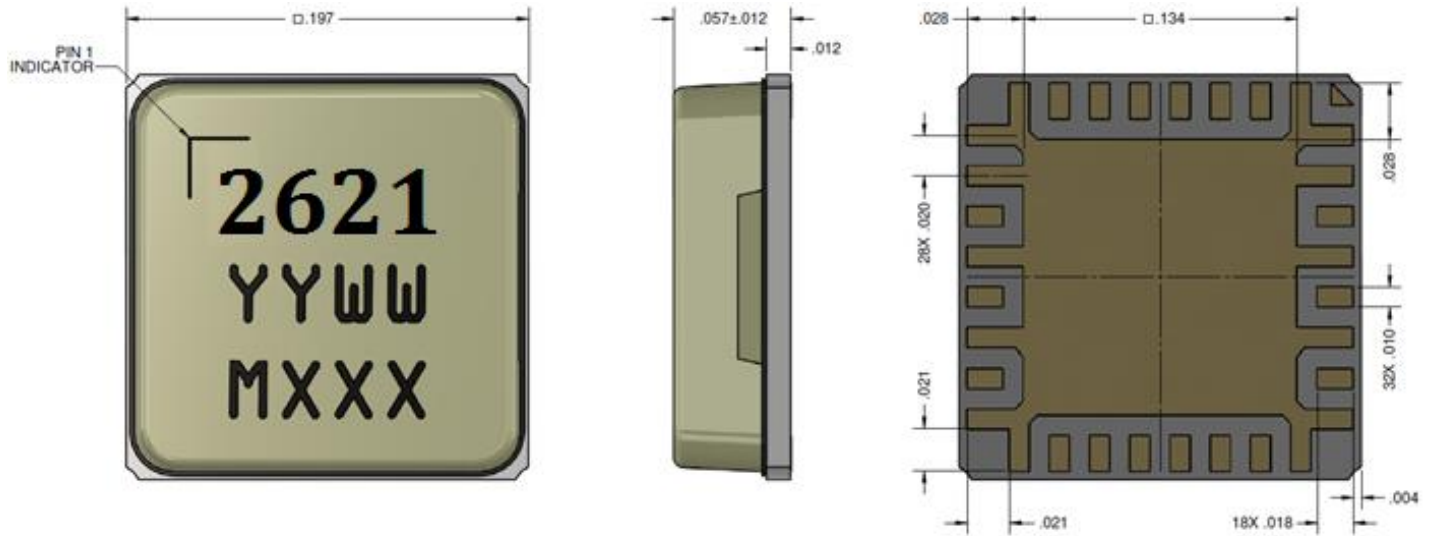

Units: inches, Tolerances: unless specified: x.xx = ± 0.01; x.xxx = ± 0.005  
 Materials: Base: Ceramic, Lid: Plastic, All metalized features are Au plated, Part is epoxy sealed  
 Marking: 2621: Part number, YY: Part Assembly year, WW: Part Assembly week, MXXX: Lot ID

**Solderability**

1. Compatible with the latest version of J-STD-020, Lead-free solder, 260 °C.
2. The use of no-clean solder to avoid washing after soldering is recommended.

**Recommended Soldering Temperature Profile**

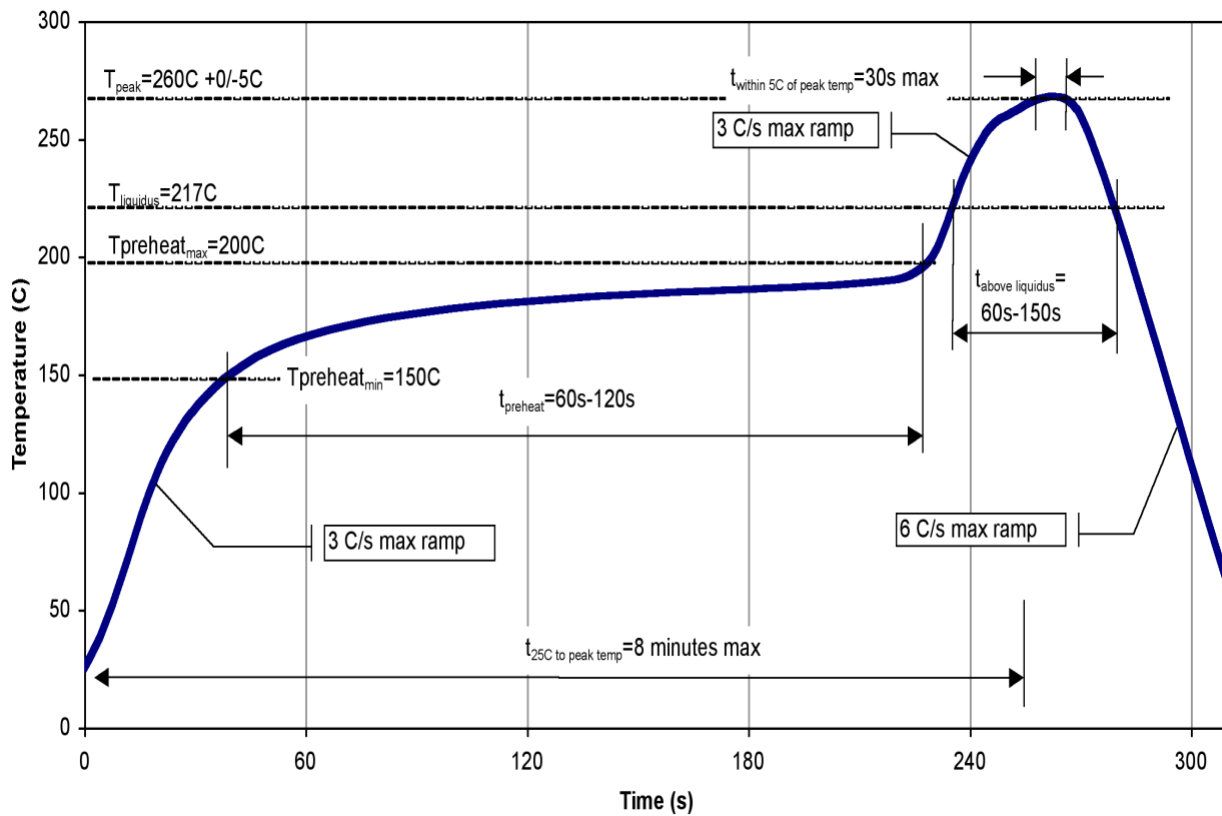

## Handling Precautions

Parameter	Rating	Standard
ESD – Human Body Model (HBM)	0B	ESDA / JEDEC JS-001-2012
ESD – Charged Device Model (CDM)	C3	ESDA / JEDEC JS-002-2014
MSL – Convection Reflow 260 °C	3	JEDEC standard IPC/JEDEC J-STD-020



Caution!  
 ESD-Sensitive Device

## RoHS Compliance

This part is compliant with EU 2011/65/EU RoHS directive (Restrictions on the Use of Certain Hazardous Substances in Electrical and Electronic Equipment) as amended by Directive 2015/863/EU.

This product also has the following attributes:

- Lead Free
- Halogen Free (Chlorine, Bromine)
- Antimony Free
- TBBP-A (C<sub>15</sub>H<sub>12</sub>Br<sub>4</sub>O<sub>2</sub>) Free
- PFOS Free
- SVHC Free

## Contact Information

For the latest specifications, additional product information, worldwide sales and distribution locations, and information about Qorvo:

**Web:** [www.qorvo.com](http://www.qorvo.com)

**Tel:** 1-844-890-8163

**Email:** [customer.support@qorvo.com](mailto:customer.support@qorvo.com)

## Important Notice

The information contained herein is believed to be reliable; however, Qorvo makes no warranties regarding the information contained herein and assumes no responsibility or liability whatsoever for the use of the information contained herein. All information contained herein is subject to change without notice. Customers should obtain and verify the latest relevant information before placing orders for Qorvo products. The information contained herein or any use of such information does not grant, explicitly or implicitly, to any party any patent rights, licenses, or any other intellectual property rights, whether with regard to such information itself or anything described by such information. **THIS INFORMATION DOES NOT CONSTITUTE A WARRANTY WITH RESPECT TO THE PRODUCTS DESCRIBED HEREIN, AND QORVO HEREBY DISCLAIMS ANY AND ALL WARRANTIES WITH RESPECT TO SUCH PRODUCTS WHETHER EXPRESS OR IMPLIED BY LAW, COURSE OF DEALING, COURSE OF PERFORMANCE, USAGE OF TRADE OR OTHERWISE, INCLUDING THE IMPLIED WARRANTIES OF MERCHANTABILITY AND FITNESS FOR A PARTICULAR PURPOSE.**

Without limiting the generality of the foregoing, Qorvo products are not warranted or authorized for use as critical components in medical, life-saving, or life-sustaining applications, or other applications where a failure would reasonably be expected to cause severe personal injury or death.

Copyright 2019 © Qorvo, Inc. | Qorvo is a registered trademark of Qorvo, Inc.