

GaN Amplifier 50 V, 100 W DC - 2.7 GHz



MAGX-100027-100C0P

Rev. V1

Features

- Suitable for Linear and Saturated Applications
- CW and Pulsed Operation: 100 W Output Power
- Internally Pre-Matched
- 260°C Reflow Compatible
- 50 V Operation
- 100% RF Tested
- RoHS* Compliant

Description

The MAGX-100027-100C0P is high power GaN on Si HEMT device optimized for DC - 2.7 GHz frequency operation. The device supports both CW and pulsed operation with peak output power levels of 100 W (50.0 dBm) in a plastic package.

The MAGX-100027-100C0P is ideally suited for a multitude of applications including military radio communications, digital cellular infrastructure, RF energy, avionics, test instrumentation and RADAR.

Typical Performance:

- $V_{DS} = 50\text{ V}$, $I_{DQ} = 200\text{ mA}$, $T_C = 25^\circ\text{C}$. Measured under pulsed load-pull at optimum efficiency load impedance, 2.5 dB Compression, 100 μs pulse width, 1 ms period, 10% duty cycle.

Frequency (GHz)	Output Power ¹ (dBm)	Gain ² (dB)	η_D^2 (%)
0.9	51.8	21.0	73.5
1.4	52.8	17.8	66.8
2.0	52.5	16.0	70.1
2.5	52.1	16.3	74.2
2.7	51.1	15.1	59.0

1. Load impedance tuned for maximum output power.

2. Load impedance tuned for maximum drain efficiency.

Ordering Information

Part Number	Package
MAGX-100027-100C0P	Bulk quantity
MAGX-100027-100CTP	Tape and Reel
MAGX-1A0027-100C0P	Sample board

* Restrictions on Hazardous Substances, compliant to current RoHS EU directive.



TO-272S-2

Functional Schematic

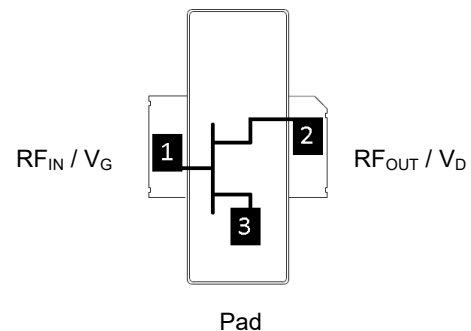

Pin Configuration

Pin #	Pin Name	Function
1	RF _{IN} / V _G	RF Input / Gate
2	RF _{OUT} / V _D	RF Output / Drain
3	Pad ³	Ground / Source

3. The exposed pad centered on the package bottom must be connected to RF, DC and thermal ground.

GaN Amplifier 50 V, 100 W

DC - 2.7 GHz



MAGX-100027-100C0P

Rev. V1

RF Electrical Characteristics: $T_C = 25^\circ\text{C}$, $V_{DS} = 50\text{ V}$, $I_{DQ} = 200\text{ mA}$

Note: Performance in MACOM Evaluation Test Fixture, 50 Ω system

Parameter	Test Conditions	Symbol	Min.	Typ.	Max.	Units
Small Signal Gain	Pulsed ⁴ , 2.5 GHz	G_{SS}	-	18.5	-	dB
Power Gain	Pulsed ⁴ , 2.5 GHz, 2.5 dB Gain Compression	G_{SAT}	-	16.6	-	dB
Saturated Drain Efficiency	Pulsed ⁴ , 2.5 GHz, 2.5 dB Gain Compression	η_{SAT}	-	67.4	-	%
Saturated Output Power	Pulsed ⁴ , 2.5 GHz, 2.5 dB Gain Compression	P_{SAT}	-	51.9	-	dBm
Gain Variation (-40°C to +85°C)	Pulsed ⁴ , 2.5 GHz	ΔG	-	0.02	-	dB/°C
Power Variation (-40°C to +85°C)	Pulsed ⁴ , 2.5 GHz	$\Delta P_{2.5dB}$	-	0.015	-	dBm/°C
Gain	Pulsed ⁴ , 2.5 GHz, $P_{IN} = 34.0\text{ dBm}$	G_P	-	17.3	-	dB
Drain Efficiency	Pulsed ⁴ , 2.5 GHz, $P_{IN} = 34.0\text{ dBm}$	η	-	67	-	%
Ruggedness: Output Mismatch	All phase angles	Ψ	VSWR = 10:1, No Damage			

RF Electrical Specifications: $T_A = 25^\circ\text{C}$, $V_{DS} = 50\text{ V}$, $I_{DQ} = 200\text{ mA}$

Note: Performance in MACOM Production Test Fixture, 50 Ω system

Parameter	Test Conditions	Symbol	Min.	Typ.	Max.	Units
Power Gain	Pulsed ⁴ , 2.5 GHz, 2.5 dB Gain Compression	G_{SAT}	15	16.6	-	dB
Saturated Drain Efficiency	Pulsed ⁴ , 2.5 GHz, 2.5 dB Gain Compression	η_{SAT}	60	67.4	-	%
Saturated Output Power	Pulsed ⁴ , 2.5 GHz, 2.5 dB Gain Compression	P_{SAT}	50	51.5	-	dBm
Gain	Pulsed ⁴ , 2.5 GHz, $P_{IN} = 34.0\text{ dBm}$	G_P	15	17.3	-	dB
Drain Efficiency	Pulsed ⁴ , 2.5 GHz, $P_{IN} = 34.0\text{ dBm}$	η	60	66.9	-	%

4. Pulse details: 100 μs pulse width, 1 ms period, 10% Duty Cycle.

DC Electrical Characteristics: $T_A = 25^\circ\text{C}$

Parameter	Test Conditions	Symbol	Min.	Typ.	Max.	Units
Drain-Source Leakage Current	$V_{GS} = -8\text{ V}$, $V_{DS} = 130\text{ V}$	I_{DLK}	-	-	21.6	mA
Gate-Source Leakage Current	$V_{GS} = -8\text{ V}$, $V_{DS} = 0\text{ V}$	I_{GLK}	-	-	21.6	mA
Gate Threshold Voltage	$V_{DS} = 50\text{ V}$, $I_D = 21.6\text{ mA}$	V_T	-2.6	-2.15	-1.6	V
Gate Quiescent Voltage	$V_{DS} = 50\text{ V}$, $I_D = 200\text{ mA}$	V_{GSQ}	-2.4	-2.05	-1.4	V
On Resistance	$V_{GS} = 2\text{ V}$, $I_D = 200\text{ mA}$	R_{ON}	-	0.22	-	Ω
Maximum Drain Current	$V_{DS} = 7\text{ V}$ pulsed, pulse width 300 μs	$I_{D, MAX}$	-	13.0	-	A

Absolute Maximum Ratings^{5,6,7,8,9}

Parameter	Absolute Maximum
Drain Source Voltage, V_{DS}	130 V
Gate Source Voltage, V_{GS}	-10 to 3 V
Gate Current, I_G	43 mA
Storage Temperature Range	-65°C to +150°C
Case Operating Temperature Range	-40°C to +85°C
Channel Operating Temperature Range, T_{CH}	-40°C to +225°C
Absolute Maximum Channel Temperature	+250°C

5. Exceeding any one or combination of these limits may cause permanent damage to this device.
6. MACOM does not recommend sustained operation above maximum operating conditions.
7. Operating at drain source voltage $V_{DS} < 55$ V will ensure $MTTF > 1 \times 10^7$ hours.
8. Operating at nominal conditions with $T_{CH} \leq 225^\circ\text{C}$ will ensure $MTTF > 1 \times 10^7$ hours.
9. MTTF may be estimated by the expression $MTTF$ (hours) = $A e^{[B + C/(T+273)]}$ where T is the channel temperature in degrees Celsius, $A = 3.686$, $B = -35.00$, and $C = 25,416$.

Thermal Characteristics¹⁰

Parameter	Test Conditions	Symbol	Typical	Units
Thermal Resistance using Finite Element Analysis	$V_{DS} = 50$ V, $T_C = 85^\circ\text{C}$, $T_{CH} = 225^\circ\text{C}$	$R_{\theta}(\text{FEA})$	1.56	°C/W
Thermal Resistance using Infrared Measurement of Die Surface Temperature	$V_{DS} = 50$ V, $T_C = 85^\circ\text{C}$, $T_{CH} = 225^\circ\text{C}$	$R_{\theta}(\text{IR})$	1.25	°C/W

10. Case temperature measured using thermocouple embedded in heat-sink. Contact local applications support team for more details on this measurement.

Handling Procedures

Please observe the following precautions to avoid damage:

Static Sensitivity

Gallium Nitride Circuits are sensitive to electrostatic discharge (ESD) and can be damaged by static electricity. Proper ESD control techniques should be used when handling these HBM Class 1B, CDM Class C3 devices.

Pulsed⁴ Load-Pull Performance
Reference Plane at Device Leads

Frequency (GHz)	Z_{SOURCE} (Ω)	Maximum Output Power					
		$V_{DS} = 50\text{ V}, I_{DQ} = 200\text{ mA}, T_C = 25^\circ\text{C}, P_{2.5dB}$					
		Z_{LOAD}^{11} (Ω)	Gain (dB)	P_{OUT} (dBm)	P_{OUT} (W)	η_D (%)	AM/PM ¹³ (°)
0.9	6 - j1.5	4.8 + j1.5	21.0	51.8	150.6	61.4	1.8
1.4	6 - j2.0	4.5 + j1.9	17.8	52.8	191.9	62.8	0.6
2.0	6 - j4.6	3.1 + j0.0	16.0	52.5	177.8	62.5	-3.5
2.5	6 - j5.5	2.4 - j0.4	16.3	52.1	162.2	68.0	-9.8
2.7	6 - j4.0	2.0 - j1.1	15.1	51.7	148.2	55.1	-4.2

Frequency (GHz)	Z_{SOURCE} (Ω)	Maximum Drain Efficiency					
		$V_{DS} = 50\text{ V}, I_{DQ} = 200\text{ mA}, T_C = 25^\circ\text{C}, P_{2.5dB}$					
		Z_{LOAD}^{12} (Ω)	Gain (dB)	P_{OUT} (dBm)	P_{OUT} (W)	η_D (%)	AM/PM ¹³ (°)
0.9	6 - j1.5	6.8 + j6.8	22.6	49.9	99.3	73.5	0.2
1.4	6 - j2.0	3.8 + j3.4	19.1	52.2	167.6	66.8	-5.8
2.0	6 - j4.6	2.2 + j2.0	17.9	51.0	125.9	70.1	-3.2
2.5	6 - j5.5	1.8 + j0.9	17.5	50.3	107.2	74.2	-11.0
2.7	6 - j4.0	1.3 + j0.1	16.7	50.1	102.3	59.0	-5.2

Impedance Reference

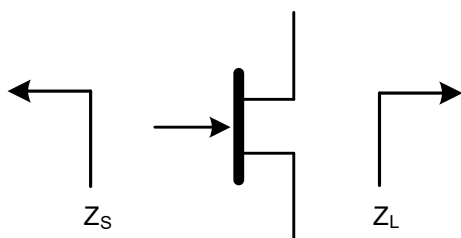

Z_{SOURCE} = Measured impedance presented to the input of the device at package reference plane.

Z_{LOAD} = Measured impedance presented to the output of the device at package reference plane.

- 11. Load Impedance for optimum output power.
- 12. Load Impedance for optimum efficiency.
- 13. AM/PM are relative values.

**Pulsed⁴ Load-Pull Performance
2.5 GHz**

P2.5dB Loadpull Output Power Contours (dBm)

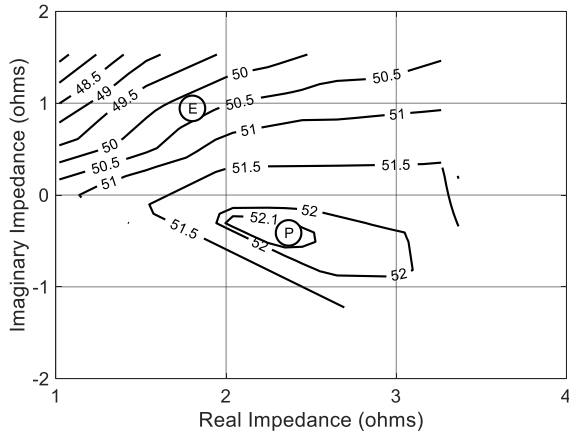

P2.5dB Loadpull Drain Efficiency Contours (%)

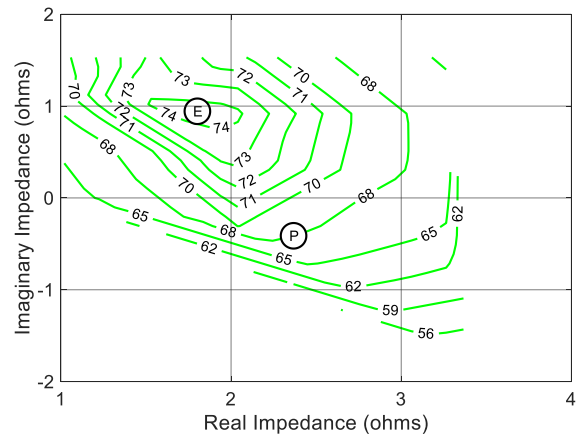

P2.5dB Loadpull Gain Contours (dB)

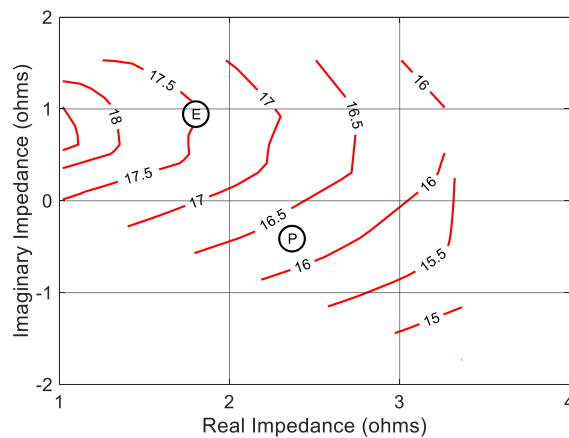

P2.5dB Loadpull AM/PM Contours (°)

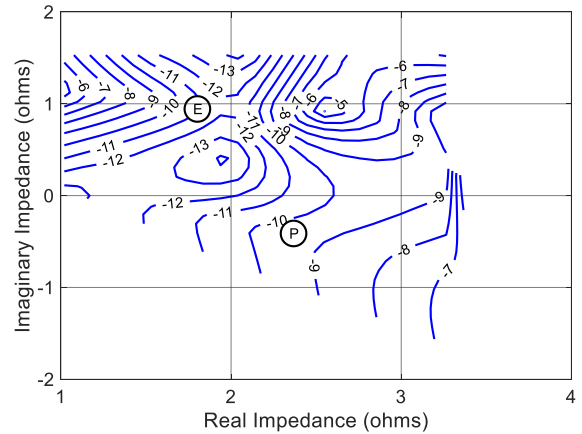

Gain vs. Output Power

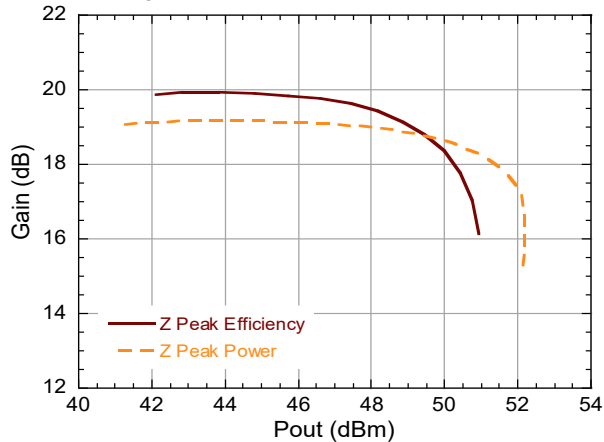

Drain Efficiency vs. Output Power

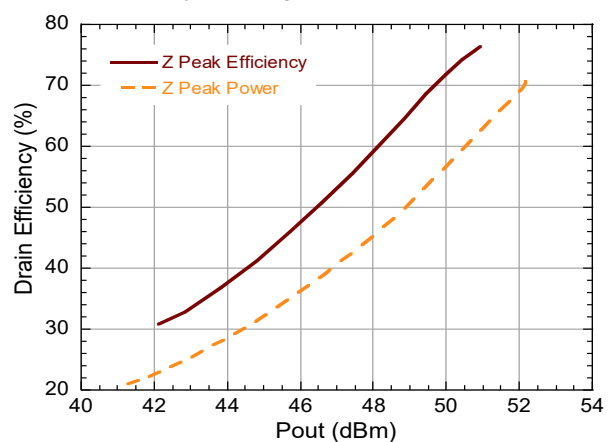

Evaluation Test Fixture and Recommended Tuning Solution 2.45 - 2.55 GHz

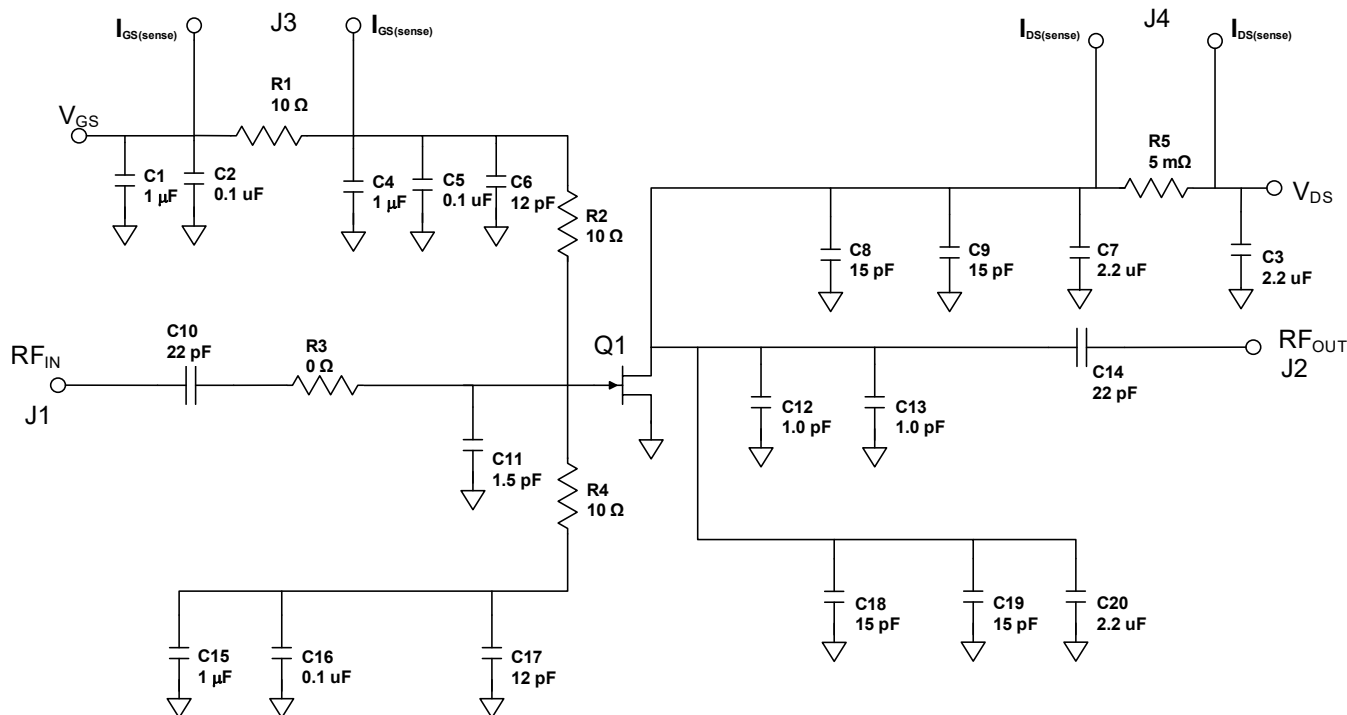

Description

Parts measured on evaluation board (20-mil thick RO4350). Matching is provided using a combination of lumped elements and transmission lines as shown in the simplified schematic above. Recommended tuning solution component placement, transmission lines, and details are shown on the next page.

Bias Sequencing

Turning the device ON

1. Set V_{GS} to pinch-off (V_P).
2. Turn on V_{DS} to nominal voltage (50 V).
3. Increase V_{GS} until I_{DS} current is reached.
4. Apply RF power to desired level.

Turning the device OFF

1. Turn the RF power off.
2. Decrease V_{GS} down to V_P pinch-off.
3. Decrease V_{DS} down to 0 V.
4. Turn off V_{GS} .

Evaluation Test Fixture and Recommended Tuning Solution 2.45 - 2.55 GHz

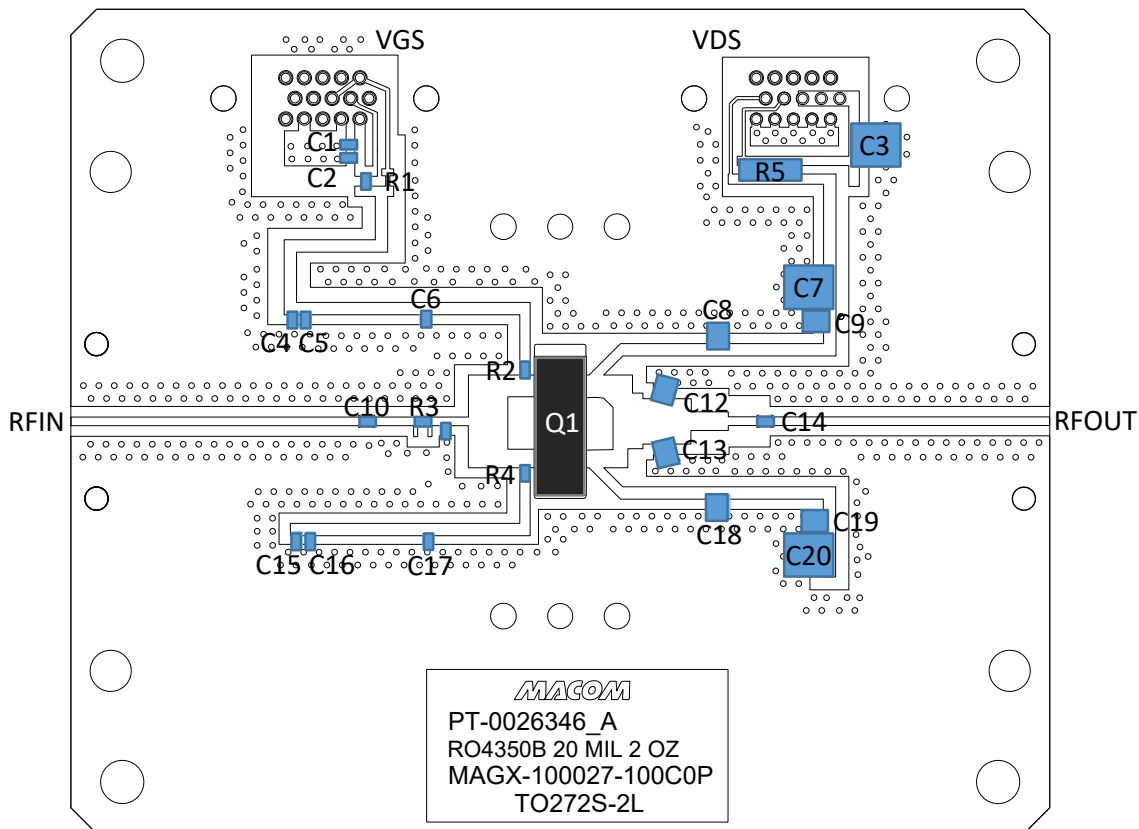

Reference Designator	Value	Tolerance	Manufacturer	Part Number
C1, C4, C15	1.0 μ F	+/- 10 %	Murata	GRM21BC72A105KE01L
C2, C5, C16	0.1 μ F	+/- 10 %	Murata	GCD21BR72A104KA01L
C3, C7, C20	2.2 μ F	+/- 10 %	Murata	KRM55TR72E225MH01L
C6, C17	12 pF	+/- 0.1 pF	PPI	0505C120BW151X
C8, C9, C18, C19	15 pF	+/- 0.1 pF	PPI	1111N150BW501X
C10, C14	22 pF	+/- 0.1 pF	PPI	0505C220BW151X
C11	1.5 pF	+/- 0.1 pF	PPI	0505C1R5BW151X
C12, C13	1 pF	+/- 0.1 pF	PPI	1111N1R0BW501X
R1, R2, R4	10 Ω	+/- 1 %	Vishay Dale	CRCW080510R0FKTA
R3	0 Ω	+/- 1 %	Vishay Dale	CRCW08050000Z0EAHP
R5	5 m Ω	+/- 1 %	Susumu	RL7520WT-R005-F
Q1	MACOM GaN Power Amplifier		MAGX-100027-100C0P	
PCB	Rogers RO4350, 20mil, 2oz Cu, Au Finish			

Typical Performance Curves as Measured in the 2.45 - 2.55 GHz Evaluation Test Fixture:
Pulsed⁴ 2.5 GHz, $V_{DS} = 50$ V, $I_{DQ} = 200$ mA, $T_C = 25^\circ\text{C}$
Unless Otherwise Noted

Gain vs. Output Power and Frequency

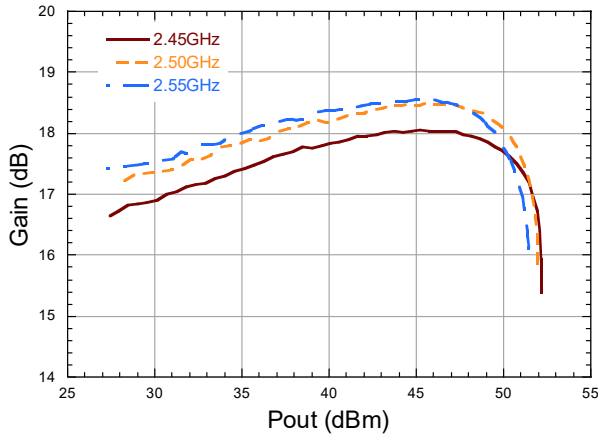

Drain Efficiency vs. Output Power and Frequency

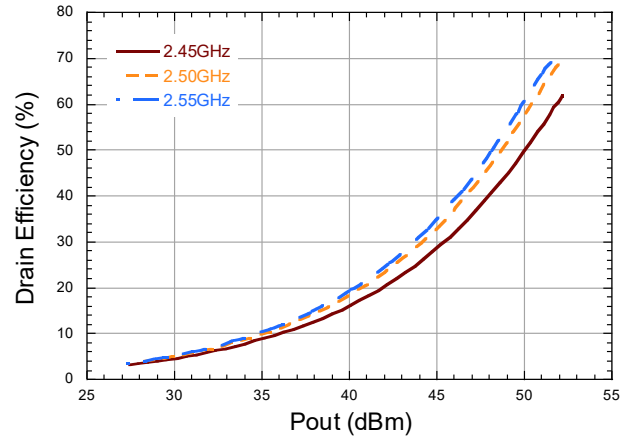

Gain vs. Output Power and V_{DS}

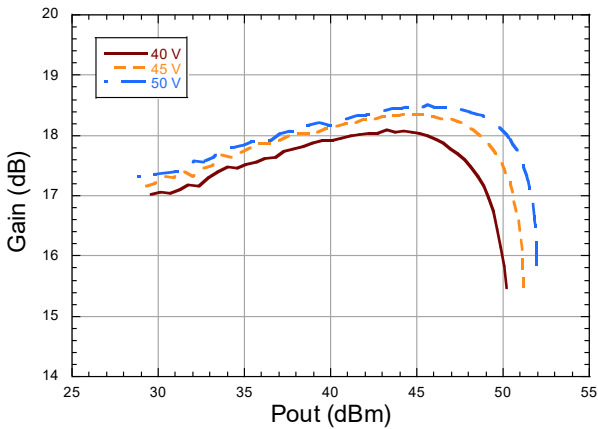

Drain Efficiency vs. Output Power and V_{DS}

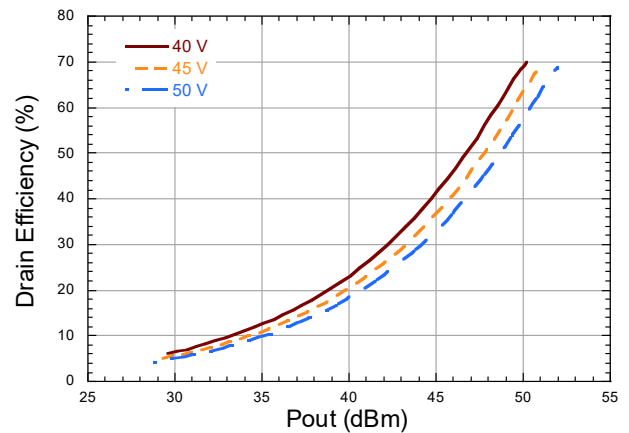

Gain vs. Output Power and I_{DQ}

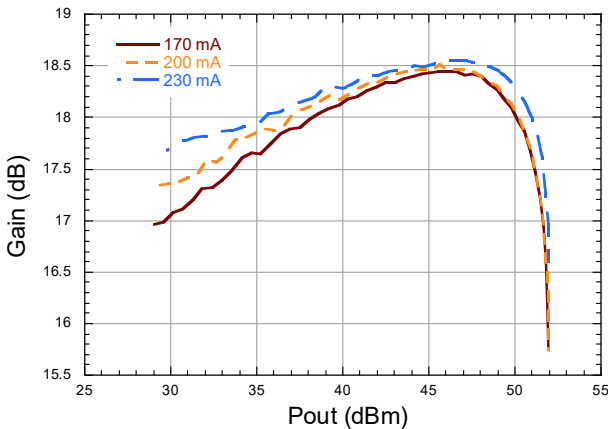

Drain Efficiency vs. Output Power and I_{DQ}

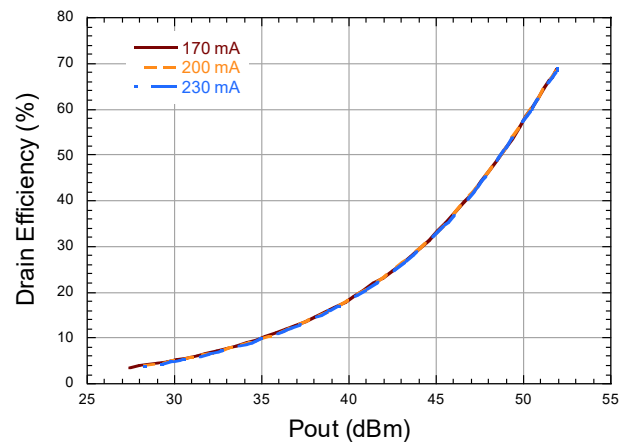

**Typical Performance Curves as Measured in the 2.45 - 2.55 GHz Evaluation Test Fixture:
Pulsed⁴ 2.5 GHz, $V_{DS} = 50$ V, $I_{DQ} = 200$ mA, $T_C = 25^\circ\text{C}$
Unless Otherwise Noted**

Gain vs. Output Power and T_c

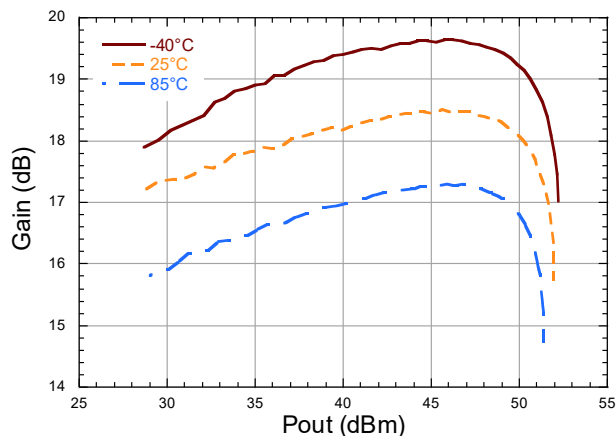

Drain Efficiency vs. Output Power and T_c

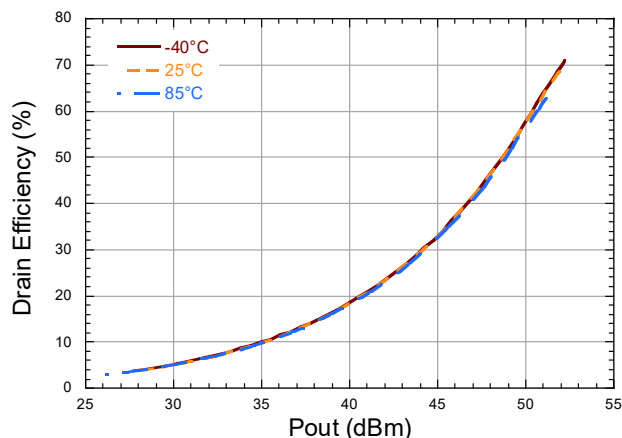

Gain vs. Frequency

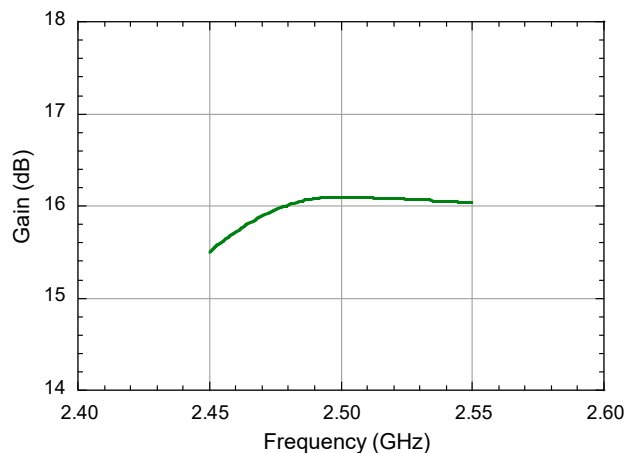

Drain Efficiency vs. Frequency

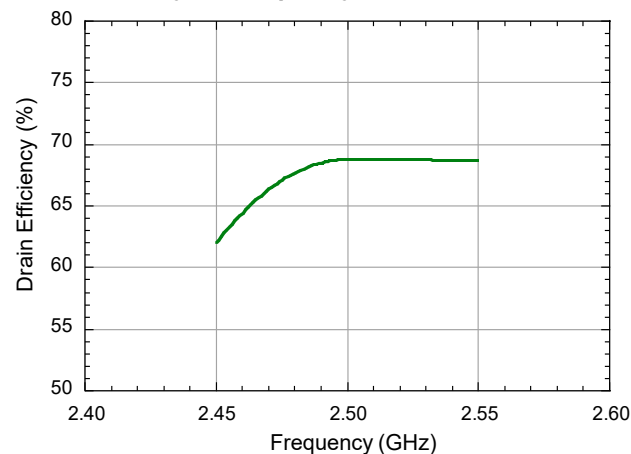

Output Power vs. Frequency

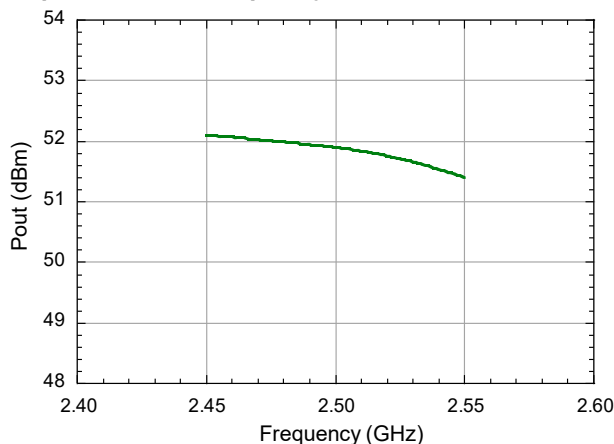

Lead-Free TO-272S-2 Package Dimensions[†]

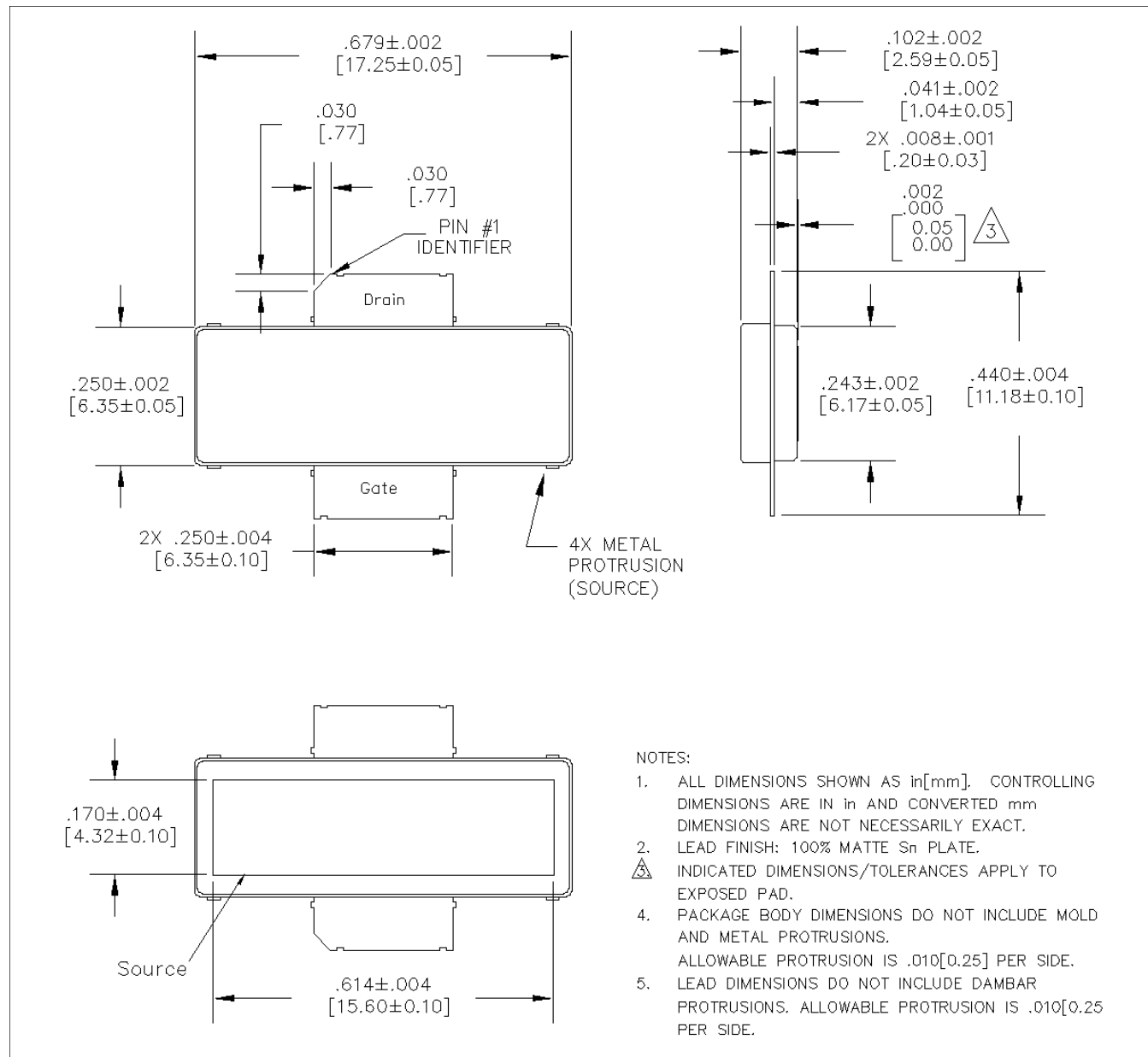

NOTES:

1. ALL DIMENSIONS SHOWN AS in[mm]. CONTROLLING DIMENSIONS ARE IN IN AND CONVERTED mm DIMENSIONS ARE NOT NECESSARILY EXACT.
2. LEAD FINISH: 100% MATTE Sn PLATE.
3. \triangle INDICATED DIMENSIONS/TOLERANCES APPLY TO EXPOSED PAD.
4. PACKAGE BODY DIMENSIONS DO NOT INCLUDE MOLD AND METAL PROTRUSIONS. ALLOWABLE PROTRUSION IS .010[0.25] PER SIDE.
5. LEAD DIMENSIONS DO NOT INCLUDE DAMBAR PROTRUSIONS. ALLOWABLE PROTRUSION IS .010[0.25] PER SIDE.

[†] Reference Application Note AN0004125 for lead-free solder reflow recommendations.
Meets JEDEC moisture sensitivity level 3 requirements.
Plating is Matte Sn.

MACOM Technology Solutions Inc. ("MACOM"). All rights reserved.

These materials are provided in connection with MACOM's products as a service to its customers and may be used for informational purposes only. Except as provided in its Terms and Conditions of Sale or any separate agreement, MACOM assumes no liability or responsibility whatsoever, including for (i) errors or omissions in these materials; (ii) failure to update these materials; or (iii) conflicts or incompatibilities arising from future changes to specifications and product descriptions, which MACOM may make at any time, without notice. These materials grant no license, express or implied, to any intellectual property rights.

THESE MATERIALS ARE PROVIDED "AS IS" WITH NO WARRANTY OR LIABILITY, EXPRESS OR IMPLIED, RELATING TO SALE AND/OR USE OF MACOM PRODUCTS INCLUDING FITNESS FOR A PARTICULAR PURPOSE, MERCHANTABILITY, INFRINGEMENT OF INTELLECTUAL PROPERTY RIGHT, ACCURACY OR COMPLETENESS, OR SPECIAL, INDIRECT, INCIDENTAL, OR CONSEQUENTIAL DAMAGES WHICH MAY RESULT FROM USE OF THESE MATERIALS.

MACOM products are not intended for use in medical, lifesaving or life sustaining applications. MACOM customers using or selling MACOM products for use in such applications do so at their own risk and agree to fully indemnify MACOM for any damages resulting from such improper use or sale.