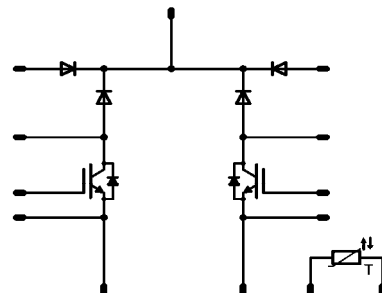

<b>flowBOOST</b>	<b>1200V/40A</b>
<div style="border: 1px solid black; padding: 5px; margin-bottom: 5px;"> <p style="text-align: center; background-color: #000080; color: white; margin: 0;"><b>Features</b></p> <ul style="list-style-type: none"> <li>High efficiency dual boost</li> <li>Ultra fast switching frequency</li> <li>Low Inductance Layout</li> <li>1200V IGBT and 1200V Si diode</li> </ul> </div> <div style="border: 1px solid black; padding: 5px; margin-bottom: 5px;"> <p style="text-align: center; background-color: #000080; color: white; margin: 0;"><b>Target Applications</b></p> <ul style="list-style-type: none"> <li>solar inverter</li> </ul> </div> <div style="border: 1px solid black; padding: 5px;"> <p style="text-align: center; background-color: #000080; color: white; margin: 0;"><b>Types</b></p> <ul style="list-style-type: none"> <li>V23990-P629-F73-PM</li> </ul> </div>	<div style="border: 1px solid black; padding: 5px; margin-bottom: 5px;"> <p style="text-align: center; background-color: #000080; color: white; margin: 0;"><b>flow0 12mm housing</b></p>  </div> <div style="border: 1px solid black; padding: 5px;"> <p style="text-align: center; background-color: #000080; color: white; margin: 0;"><b>Schematic</b></p>  </div>

### Maximum Ratings

T<sub>j</sub>=25°C, unless otherwise specified

Parameter	Symbol	Condition	Value	Unit	
<b>Bypass Diode</b>					
Repetitive peak reverse voltage	V <sub>RRM</sub>	T <sub>j</sub> =25°C	1600	V	
DC forward current	I <sub>FAV</sub>	T <sub>j</sub> =T <sub>jmax</sub>	T <sub>h</sub> =80°C	34	A
			T <sub>c</sub> =80°C	46	
Surge forward current	I <sub>FSM</sub>	t <sub>p</sub> =10ms sin 180°	220	A	
I <sup>2</sup> t-value	I <sup>2</sup> t	T <sub>j</sub> =25°C	200	A <sup>2</sup> s	
Power dissipation per Diode	P <sub>tot</sub>	T <sub>j</sub> =T <sub>jmax</sub>	T <sub>h</sub> =80°C	41	W
			T <sub>c</sub> =80°C	62	
Maximum Junction Temperature	T <sub>jmax</sub>		150	°C	
<b>Boost IGBT</b>					
Collector-emitter break down voltage	V <sub>CE</sub>	T <sub>j</sub> =25°C	1200	V	
DC collector current	I <sub>C</sub>	T <sub>j</sub> =T <sub>jmax</sub>	T <sub>h</sub> =80°C	34	A
			T <sub>c</sub> =80°C	47	
Pulsed collector current	I <sub>Cpulse</sub>	t <sub>p</sub> limited by T <sub>jmax</sub>	160	A	
Turn off safe operating area		V <sub>CE</sub> ≤ 800V, T <sub>j</sub> ≤ Top max	160	A	
Power dissipation per IGBT	P <sub>tot</sub>	T <sub>j</sub> =T <sub>jmax</sub>	T <sub>h</sub> =80°C	108	W
			T <sub>c</sub> =80°C	164	
Gate-emitter peak voltage	V <sub>GE</sub>		±25	V	
Short circuit ratings	t <sub>SC</sub> V <sub>CC</sub>	T <sub>j</sub> ≤ 150°C V <sub>GE</sub> = 15V	10	μs	
			600	V	
Maximum Junction Temperature	T <sub>jmax</sub>		150	°C	

## Maximum Ratings

 $T_j=25^{\circ}\text{C}$ , unless otherwise specified

Parameter	Symbol	Condition	Value	Unit
-----------	--------	-----------	-------	------

### Boost IGBT Protection Diode

Peak Repetitive Reverse Voltage	$V_{RRM}$	$T_j=25^{\circ}\text{C}$	1600	V
DC forward current	$I_F$	$T_j=T_{jmax}$	$T_h=80^{\circ}\text{C}$ 47 $T_c=80^{\circ}\text{C}$	A
Surge forward current	$I_{FSM}$	$t_p=10\text{ms, sin } 180^{\circ}$	220	A
Power dissipation per Diode	$P_{tot}$	$T_j=T_{jmax}$	$T_h=80^{\circ}\text{C}$ 62 $T_c=80^{\circ}\text{C}$	W
Maximum Junction Temperature	$T_{jmax}$		150	$^{\circ}\text{C}$

### Boost FWD

Peak Repetitive Reverse Voltage	$V_{RRM}$	$T_j=25^{\circ}\text{C}$	1200	V
DC forward current	$I_F$	$T_j=T_{jmax}$	$T_h=80^{\circ}\text{C}$ 50 $T_c=80^{\circ}\text{C}$	A
Repetitive peak forward current	$I_{FRM}$	$t_p$ limited by $T_{jmax}$	150	A
Power dissipation	$P_{tot}$	$T_j=T_{jmax}$	$T_h=80^{\circ}\text{C}$ 125 $T_c=80^{\circ}\text{C}$	W
Maximum Junction Temperature	$T_{jmax}$		175	$^{\circ}\text{C}$

### Thermal Properties

Storage temperature	$T_{slg}$		-40...+125	$^{\circ}\text{C}$
Operation temperature under switching condition	$T_{op}$		-40...+( $T_{jmax} - 25$ )	$^{\circ}\text{C}$

### Insulation Properties

Insulation voltage	$V_{is}$	$t=2\text{s}$ DC voltage	4000	V
Creepage distance			min 12,7	mm
Clearance			min 12,7	mm

**Characteristic Values**

Parameter	Symbol	Conditions					Value			Unit
		$V_{GE}[V]$ or $V_{GS}[V]$	$V_r[V]$ or $V_{CE}[V]$ or $V_{DS}[V]$	$I_c[A]$ or $I_F[A]$ or $I_b[A]$	$T_j$	Min	Typ	Max		
<b>Bypass Diode</b>										
Forward voltage	$V_F$			25	$T_j=25^\circ\text{C}$ $T_j=125^\circ\text{C}$		1,13 1,09	1,21		V
Threshold voltage (for power loss calc. only)	$V_{to}$			40	$T_j=25^\circ\text{C}$ $T_j=125^\circ\text{C}$		0,93 0,80			V
Slope resistance (for power loss calc. only)	$r_t$			40	$T_j=25^\circ\text{C}$ $T_j=125^\circ\text{C}$		0,008 0,011			$\Omega$
Reverse current	$I_r$		1600		$T_j=25^\circ\text{C}$ $T_j=125^\circ\text{C}$			0,05		mA
Thermal resistance chip to heatsink per chip	$R_{thJH}$	Thermal grease thickness $\leq$ 50um $\lambda = 1 \text{ W/mK}$					1,71			K/W
Thermal resistance chip to case per chip	$R_{thJC}$						1,13			
<b>Boost IGBT</b>										
Gate emitter threshold voltage	$V_{GE(th)}$	VCE=VGE		0,00025	$T_j=25^\circ\text{C}$ $T_j=125^\circ\text{C}$	3,5	5,5	7,5		V
Collector-emitter saturation voltage	$V_{CE(sat)}$		15	40	$T_j=25^\circ\text{C}$ $T_j=125^\circ\text{C}$		2,74 3,01	3,2		V
Collector-emitter cut-off	$I_{CES}$		0	1200	$T_j=25^\circ\text{C}$ $T_j=125^\circ\text{C}$			1		mA
Gate-emitter leakage current	$I_{GES}$		$\pm$ 25	0	$T_j=25^\circ\text{C}$ $T_j=125^\circ\text{C}$			$\pm$ 250		nA
Integrated Gate resistor	$R_{gint}$						none			$\Omega$
Turn-on delay time	$t_{d(on)}$	Rgoff=4 $\Omega$ Rgon=4 $\Omega$	15	700	40	$T_j=25^\circ\text{C}$	26			ns
Rise time	$t_r$					$T_j=125^\circ\text{C}$	25			
Turn-off delay time	$t_{d(off)}$					$T_j=25^\circ\text{C}$	16			
Fall time	$t_f$					$T_j=125^\circ\text{C}$	43			
						$T_j=25^\circ\text{C}$	169			
		$T_j=125^\circ\text{C}$	199							
Turn-on energy loss per pulse	$E_{on}$					$T_j=25^\circ\text{C}$	1,47			mWs
Turn-off energy loss per pulse	$E_{off}$					$T_j=125^\circ\text{C}$	2,23			
						$T_j=25^\circ\text{C}$	0,93			
						$T_j=125^\circ\text{C}$	1,87			
Input capacitance	$C_{ies}$						3200			pF
Output capacitance	$C_{oss}$	f=1MHz	0	30	$T_j=25^\circ\text{C}$		370			
Reverse transfer capacitance	$C_{riss}$						125			
Gate charge	$Q_{Gate}$		15	600	40	$T_j=25^\circ\text{C}$		220		nC
Thermal resistance chip to heatsink per chip	$R_{thJH}$	Thermal grease thickness $\leq$ 50um $\lambda = 1 \text{ W/mK}$					0,65			K/W
Thermal resistance chip to case per chip	$R_{thJC}$						0,43			
<b>Boost IGBT Protection Diode</b>										
Diode forward voltage	$V_F$			25	$T_j=25^\circ\text{C}$ $T_j=125^\circ\text{C}$		1,13 1,08	1,21		V
Thermal resistance chip to heatsink per chip	$R_{thJH}$	Thermal grease thickness $\leq$ 50um $\lambda = 1 \text{ W/mK}$					1,71			K/W
Thermal resistance chip to case per chip	$R_{thJC}$						1,13			
<b>Boost FWD</b>										
Forward voltage	$V_F$			50	$T_j=25^\circ\text{C}$ $T_j=125^\circ\text{C}$		2,25 2,32	2,54		V
Reverse leakage current	$I_{rm}$		15	700	40	$T_j=25^\circ\text{C}$ $T_j=125^\circ\text{C}$		60		$\mu\text{A}$
Peak recovery current	$I_{RRM}$	Rgon=4 $\Omega$	15	700	40	$T_j=25^\circ\text{C}$	98			A
Reverse recovery time	$t_{rr}$					$T_j=125^\circ\text{C}$	117			
						$T_j=25^\circ\text{C}$	78			
						$T_j=125^\circ\text{C}$	152			
						$T_j=25^\circ\text{C}$	3,71			
Reverse recovery charge	$Q_{rr}$					$T_j=125^\circ\text{C}$	7,08			$\mu\text{C}$
Reverse recovered energy	$E_{rec}$					$T_j=25^\circ\text{C}$	1,83			mWs
						$T_j=125^\circ\text{C}$	3,69			
Peak rate of fall of recovery current	$di(rec)max/dt$					$T_j=25^\circ\text{C}$	5120			A/ $\mu\text{s}$
						$T_j=125^\circ\text{C}$	4285			
Thermal resistance chip to heatsink per chip	$R_{thJH}$	Thermal grease thickness $\leq$ 50um $\lambda = 1 \text{ W/mK}$					1,16			K/W
Thermal resistance chip to case per chip	$R_{thJC}$						0,76			

**Characteristic Values**

Parameter	Symbol	Conditions					Value			Unit
		$V_{GE}[V]$ or $V_{GS}[V]$	$V_r[V]$ or $V_{CE}[V]$ or $V_{DS}[V]$	$I_c[A]$ or $I_F[A]$ or $I_D[A]$	$T_j$	Min	Typ	Max		
<b>Thermistor</b>										
Rated resistance	R	Tol. $\pm 5\%$				$T_j=25^\circ\text{C}$		22000		$\Omega$
Deviation of R25	$\Delta R/R$	R100=1503 $\Omega$				$T_c=100^\circ\text{C}$	-5		+5	%
Power dissipation	P					$T_j=25^\circ\text{C}$		200		mW
Power dissipation constant						$T_j=25^\circ\text{C}$		2		mW/K
B-value	B(25/50)	Tol. $\pm 3\%$				$T_j=25^\circ\text{C}$		3950		K
B-value	B(25/100)	Tol. $\pm 3\%$				$T_j=25^\circ\text{C}$		3996		K
Vincotech NTC Reference									B	

## Boost IGBT Protection Diode

**Figure 1** Boost IGBT Protection Diode

**Typical FWD forward current as a function of forward voltage**

$$I_F = f(V_F)$$

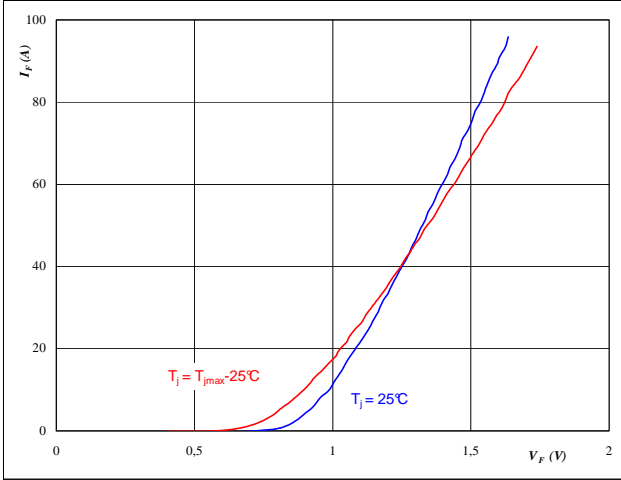
**At**  
 $t_p = 250 \mu s$ 
**Figure 2** Boost IGBT Protection Diode

**Diode transient thermal impedance as a function of pulse width**

$$Z_{thJH} = f(t_p)$$

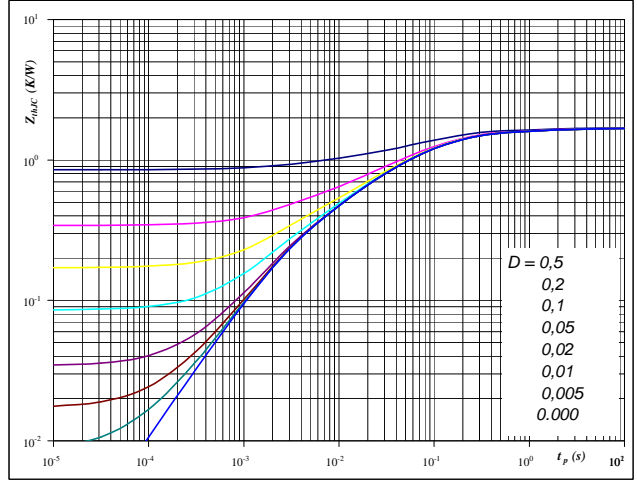
**At**  
 $D = t_p / T$   
 $R_{thJH} = 1,71 \text{ K/W}$ 
**Figure 3** Boost IGBT Protection Diode

**Power dissipation as a function of heatsink temperature**

$$P_{tot} = f(T_h)$$

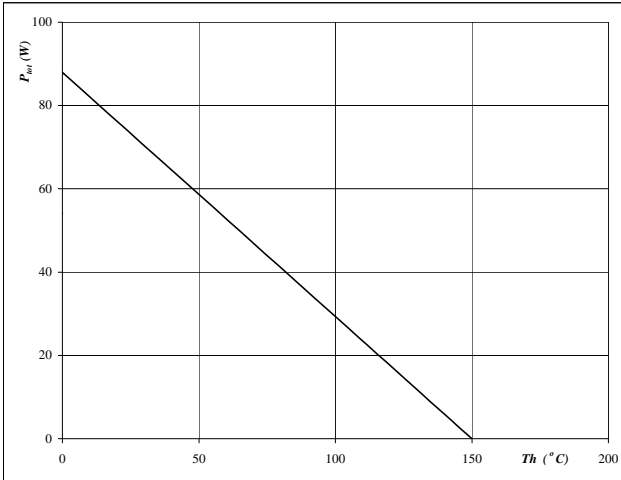
**At**  
 $T_j = 150 \text{ °C}$ 
**Figure 4** Boost IGBT Protection Diode

**Forward current as a function of heatsink temperature**

$$I_F = f(T_h)$$

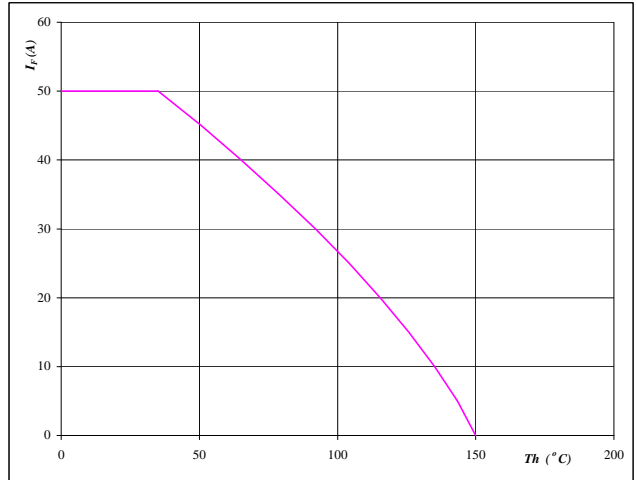
**At**  
 $T_j = 150 \text{ °C}$

## INPUT BOOST

**Figure 3** BOOST IGBT
**Typical output characteristics**

$I_C = f(V_{CE})$

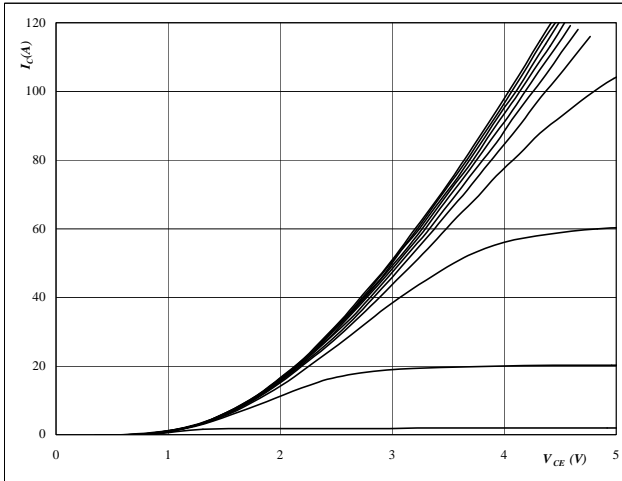

**At**  
 $t_p = 250 \mu s$   
 $T_j = 25 \text{ }^\circ C$   
 $V_{GS}$  from 7 V to 17 V in steps of 1 V

**Figure 4** BOOST FWD
**Typical output characteristics**

$I_C = f(V_{CE})$

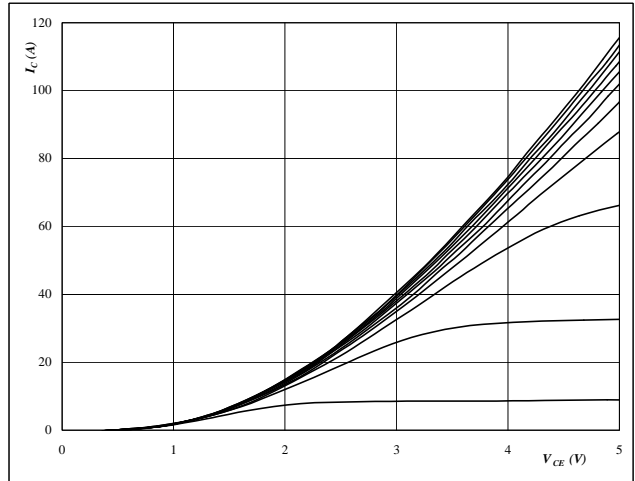

**At**  
 $t_p = 250 \mu s$   
 $T_j = 125 \text{ }^\circ C$   
 $V_{GS}$  from 7 V to 17 V in steps of 1 V

**Figure 3** BOOST IGBT
**Typical transfer characteristics**

$I_C = f(V_{GE})$

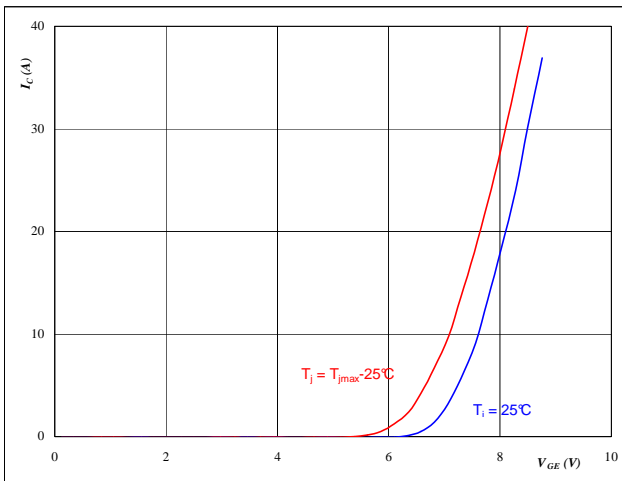

**At**  
 $t_p = 250 \mu s$   
 $V_{DS} = 10 V$

**Figure 4** BOOST FWD
**Typical FWD forward current as a function of forward voltage**

$I_F = f(V_F)$

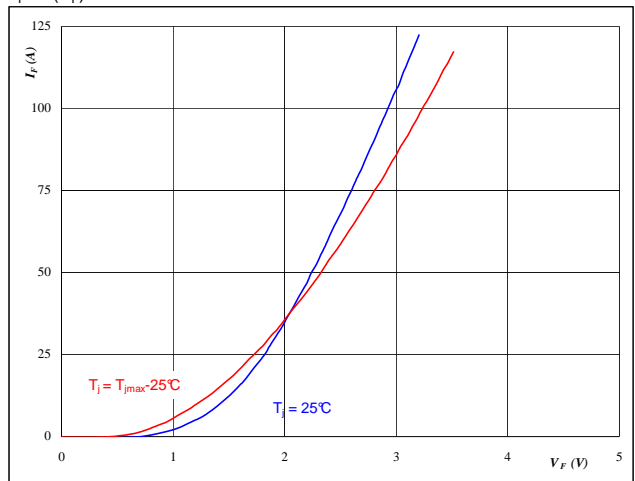

**At**  
 $t_p = 250 \mu s$

## INPUT BOOST

**Figure 5** BOOST IGBT

**Typical switching energy losses  
as a function of collector current**

$$E = f(I_C)$$

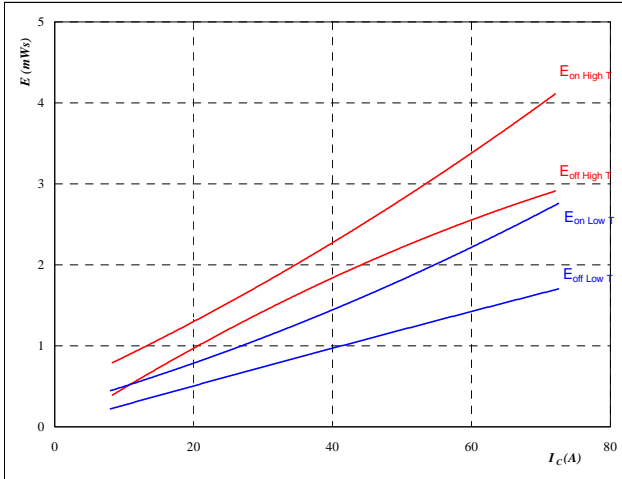

With an inductive load at

$T_J =$	25/126	°C
$V_{DS} =$	700	V
$V_{GS} =$	15	V
$R_{gon} =$	4	Ω
$R_{goff} =$	4	Ω

**Figure 6** BOOST IGBT

**Typical switching energy losses  
as a function of gate resistor**

$$E = f(R_G)$$

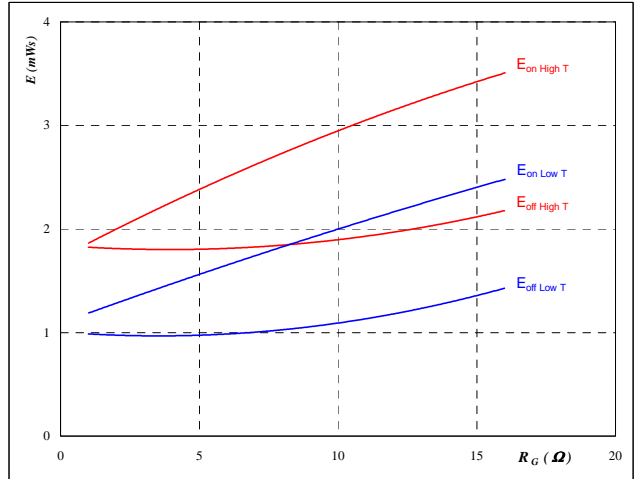

With an inductive load at

$T_J =$	25/126	°C
$V_{DS} =$	700	V
$V_{GS} =$	15	V
$I_D =$	40	A

**Figure 7** BOOST IGBT

**Typical reverse recovery energy loss  
as a function of collector (drain) current**

$$E_{rec} = f(I_C)$$

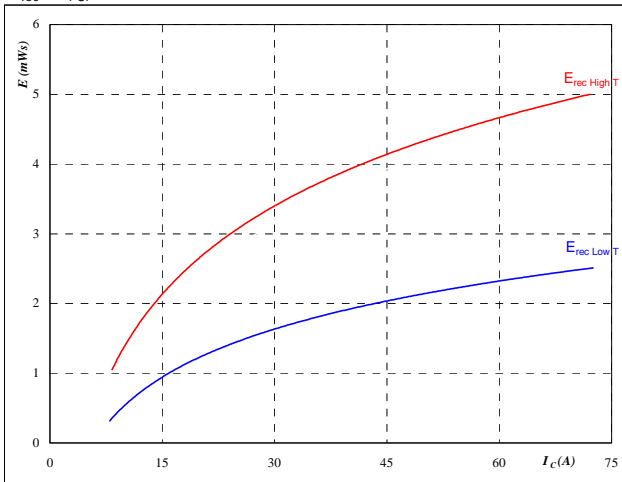

With an inductive load at

$T_J =$	25/126	°C
$V_{DS} =$	700	V
$V_{GS} =$	15	V
$R_{gon} =$	4	Ω

**Figure 8** BOOST IGBT

**Typical reverse recovery energy loss  
as a function of gate resistor**

$$E_{rec} = f(R_G)$$

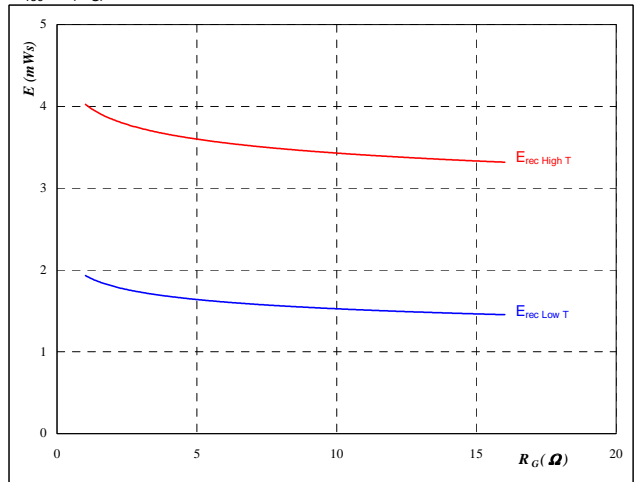

With an inductive load at

$T_J =$	25/126	°C
$V_{DS} =$	700	V
$V_{GS} =$	15	V
$I_D =$	40	A

## INPUT BOOST

**Figure 9** BOOST IGBT

Typical switching times as a function of collector current

$$t = f(I_C)$$

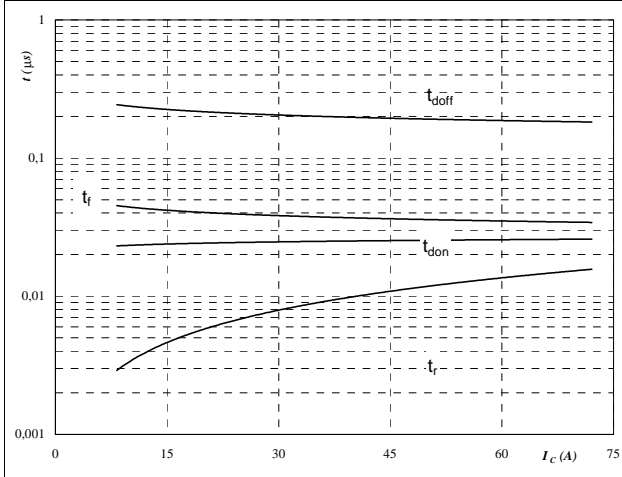

With an inductive load at

$T_J =$	126	°C
$V_{DS} =$	700	V
$V_{GS} =$	15	V
$R_{gon} =$	4	Ω
$R_{goff} =$	4	Ω

**Figure 10** BOOST IGBT

Typical switching times as a function of gate resistor

$$t = f(R_G)$$

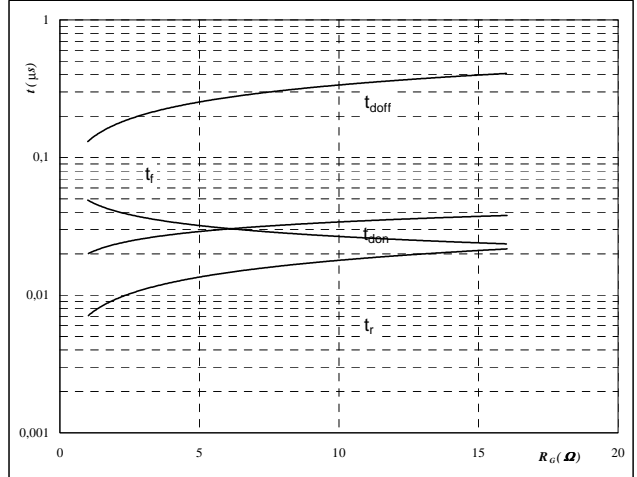

With an inductive load at

$T_J =$	126	°C
$V_{DS} =$	700	V
$V_{GS} =$	15	V
$I_C =$	40	A

**Figure 11** BOOST FWD

Typical reverse recovery time as a function of collector current

$$t_{rr} = f(I_C)$$

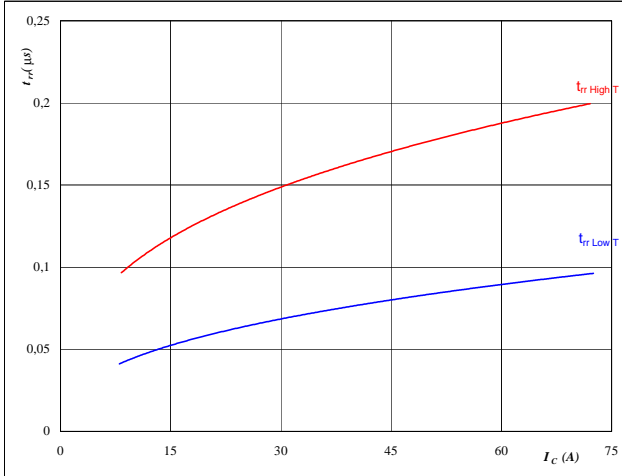

At

$T_J =$	25/126	°C
$V_{CE} =$	700	V
$V_{GE} =$	15	V
$R_{gon} =$	4	Ω

**Figure 12** BOOST FWD

Typical reverse recovery time as a function of IGBT turn on gate resistor

$$t_{rr} = f(R_{gon})$$

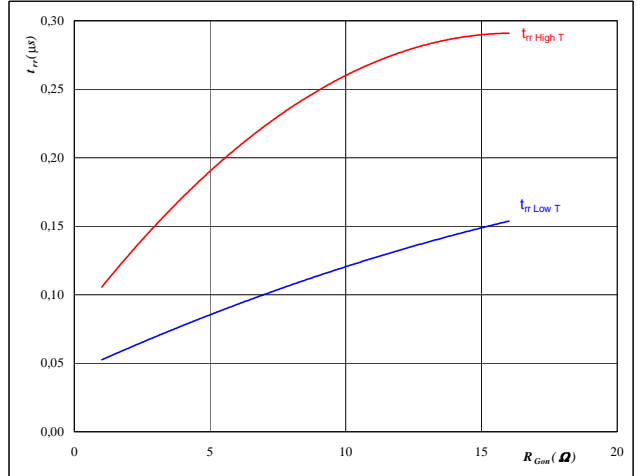

At

$T_J =$	25/126	°C
$V_R =$	700	V
$I_F =$	40	A
$V_{GS} =$	15	V



## INPUT BOOST

**Figure 13** BOOST FWD

Typical reverse recovery charge as a function of collector current

$$Q_{rr} = f(I_C)$$

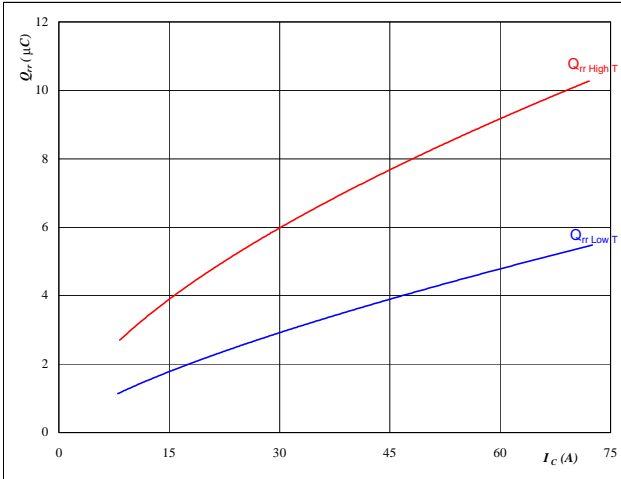

**At**  
 $T_j = 25/126$  °C  
 $V_{CE} = 700$  V  
 $V_{GE} = 15$  V  
 $R_{gon} = 4$   $\Omega$

**Figure 14** BOOST FWD

Typical reverse recovery charge as a function of IGBT turn on gate resistor

$$Q_{rr} = f(R_{gon})$$

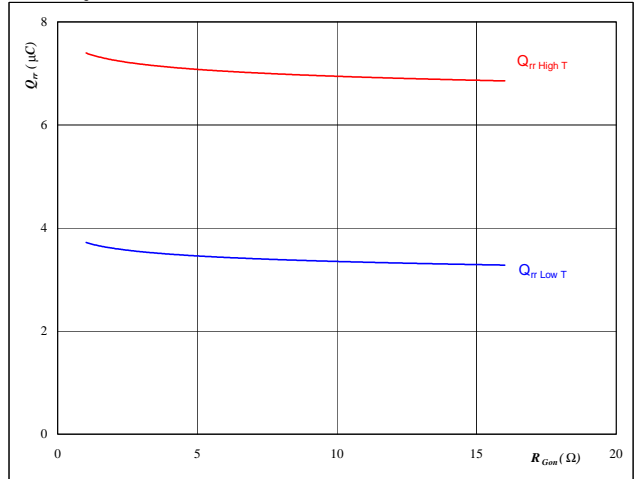

**At**  
 $T_j = 25/126$  °C  
 $V_R = 700$  V  
 $I_F = 40$  A  
 $V_{GS} = 15$  V

**Figure 15** BOOST FWD

Typical reverse recovery current as a function of collector current

$$I_{RRM} = f(I_C)$$

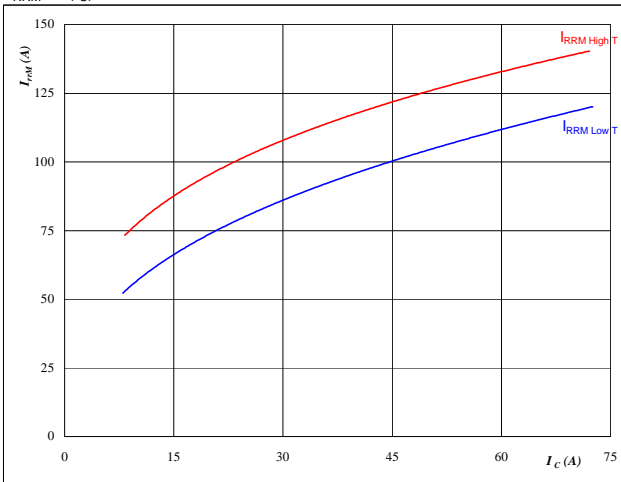

**At**  
 $T_j = 25/126$  °C  
 $V_{CE} = 700$  V  
 $V_{GE} = 15$  V  
 $R_{gon} = 4$   $\Omega$

**Figure 16** BOOST FWD

Typical reverse recovery current as a function of IGBT turn on gate resistor

$$I_{RRM} = f(R_{gon})$$

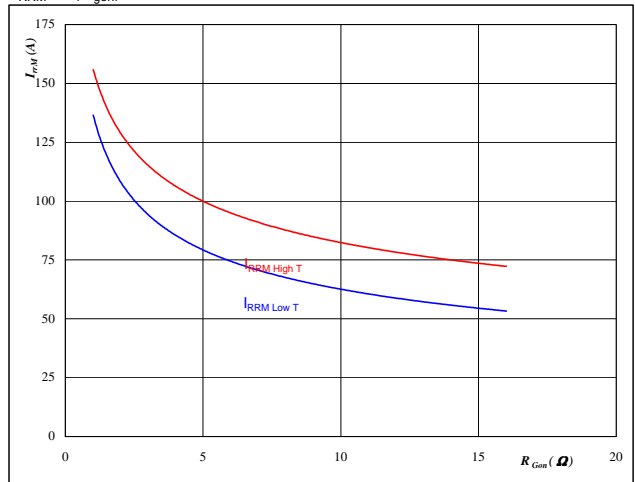

**At**  
 $T_j = 25/126$  °C  
 $V_R = 700$  V  
 $I_F = 40$  A  
 $V_{GS} = 15$  V

## INPUT BOOST

**Figure 17** BOOST FWD

Typical rate of fall of forward and reverse recovery current as a function of collector current

$$dI_f/dt, dI_{rec}/dt = f(I_c)$$

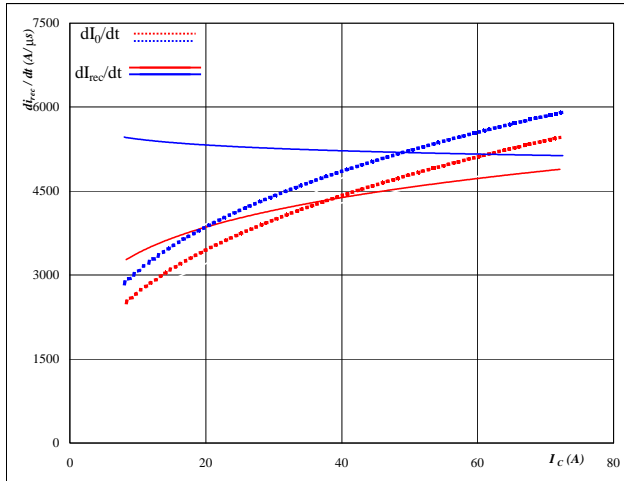

At

$T_j =$	25/126	°C
$V_{CE} =$	700	V
$V_{GE} =$	15	V
$R_{gon} =$	4	Ω

**Figure 18** BOOST FWD

Typical rate of fall of forward and reverse recovery current as a function of IGBT turn on gate resistor

$$dI_f/dt, dI_{rec}/dt = f(R_{gon})$$

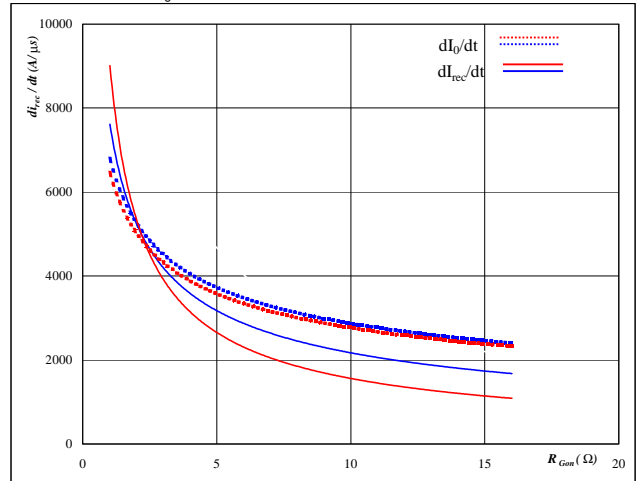

At

$T_j =$	25/126	°C
$V_R =$	700	V
$I_F =$	40	A
$V_{GS} =$	15	V

**Figure 19** BOOST IGBT

IGBT/MOSFET transient thermal impedance as a function of pulse width

$$Z_{thJH} = f(t_p)$$

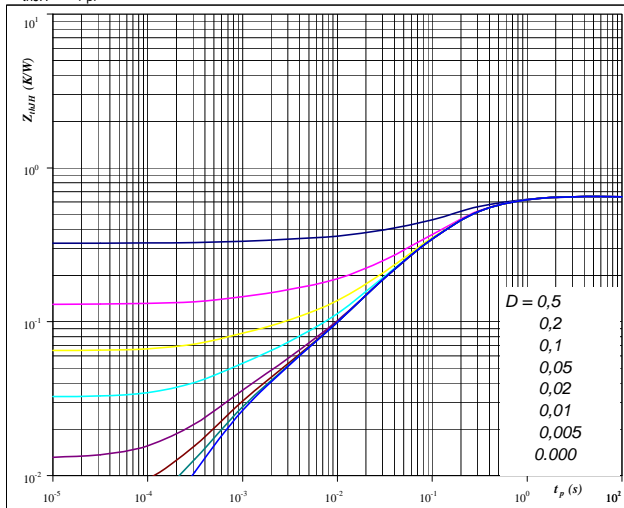

At

$D =$	$t_p / T$	
$R_{thJH} =$	0,65	K/W

IGBT thermal model values

R (C/W)	Tau (s)
0,198	0,495
0,347	0,111
0,075	0,015
0,028	0,001
0,027	0,004

**Figure 20** BOOST FWD

FWD transient thermal impedance as a function of pulse width

$$Z_{thJH} = f(t_p)$$

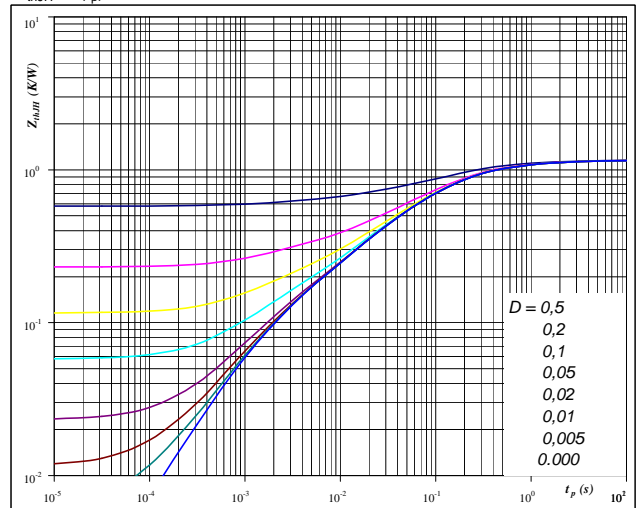

At

$D =$	$t_p / T$	
$R_{thJH} =$	1,16	K/W

FWD thermal model values

R (C/W)	Tau (s)
0,041	5,298
0,115	1,001
0,447	0,186
0,324	0,053
0,154	0,012

## INPUT BOOST

**Figure 21** BOOST IGBT
**Power dissipation as a function of heatsink temperature**

$$P_{tot} = f(T_h)$$

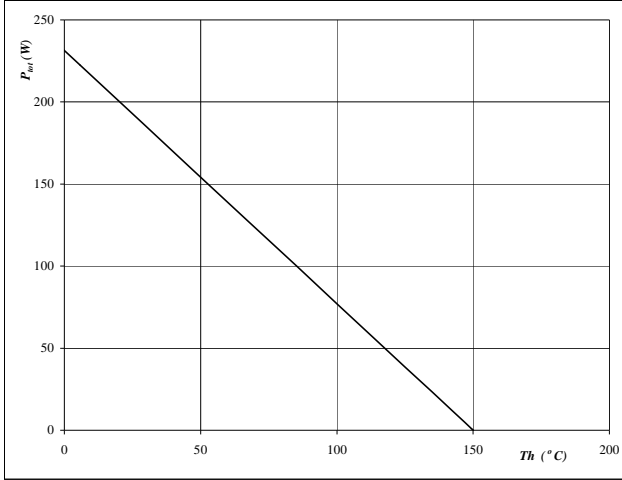
**At**  
 T<sub>j</sub> = 150 °C

**Figure 22** BOOST IGBT
**Collector/Drain current as a function of heatsink temperature**

$$I_C = f(T_h)$$

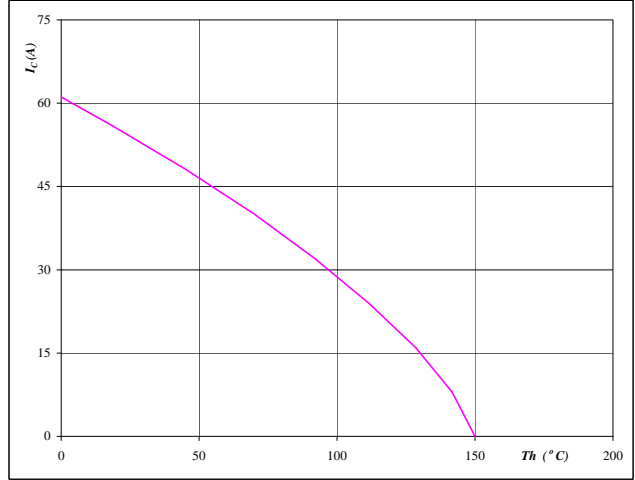
**At**  
 T<sub>j</sub> = 150 °C  
 V<sub>GS</sub> = 15 V

**Figure 23** BOOST FWD
**Power dissipation as a function of heatsink temperature**

$$P_{tot} = f(T_h)$$

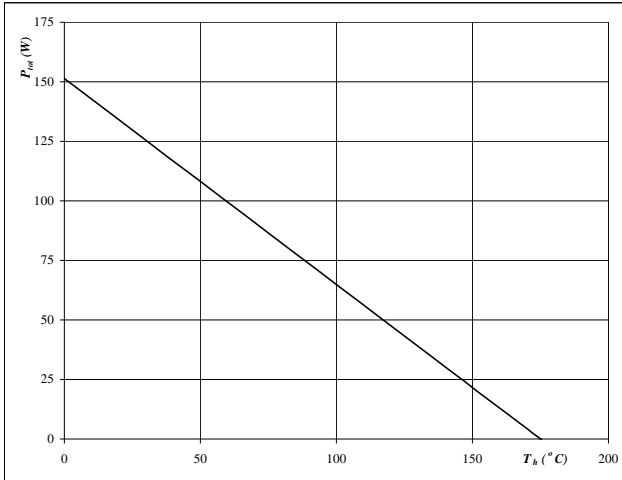
**At**  
 T<sub>j</sub> = 175 °C

**Figure 24** BOOST FWD
**Forward current as a function of heatsink temperature**

$$I_F = f(T_h)$$

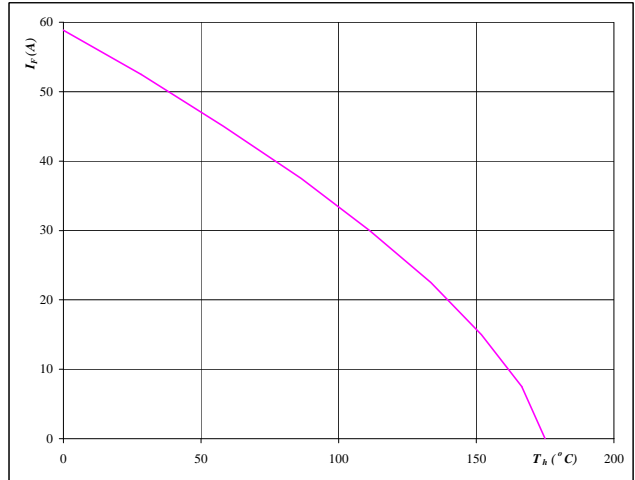

**At**  
 T<sub>j</sub> = 175 °C

## INPUT BOOST

**Figure 25** BOOST IGBT

**Safe operating area as a function of drain-source voltage**

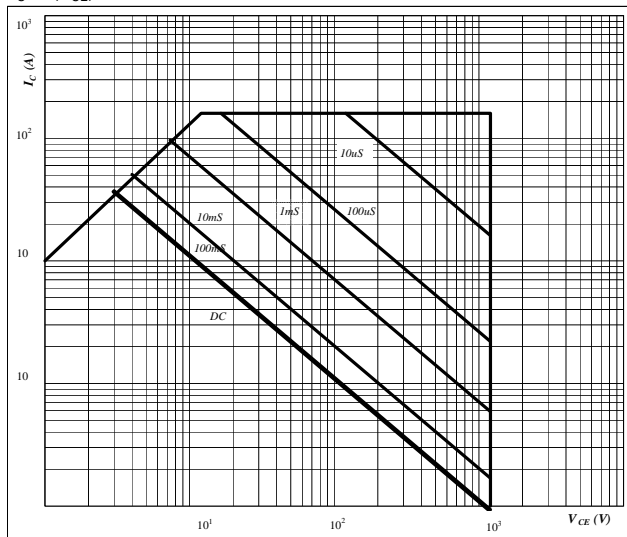
$$I_C = f(V_{CE})$$



**At**  
 D = single pulse  
 $T_n = 80$  °C  
 $V_{GS} = 15$  V  
 $T_j = T_{jmax}$  °C

**Figure 26** BOOST IGBT

**Gate voltage vs Gate charge**

$$V_{GE} = f(Q_g)$$

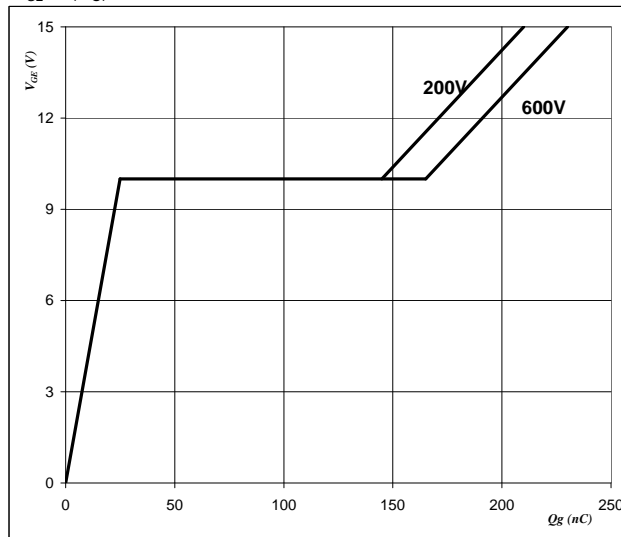

**At**  
 $I_D = 40$  A

## Bypass Diode

**Figure 1** Bypass Diode

**Typical Diode forward current as a function of forward voltage**

$$I_F = f(V_F)$$

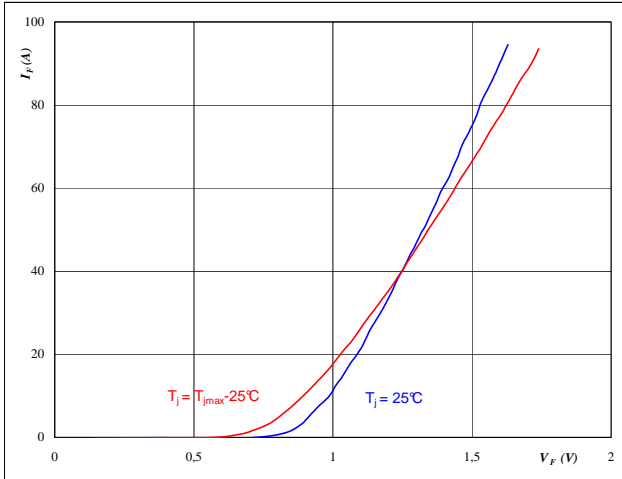
**At**  
 $t_p = 250 \mu s$ 
**Figure 2** Bypass Diode

**Diode transient thermal impedance as a function of pulse width**

$$Z_{thJH} = f(t_p)$$

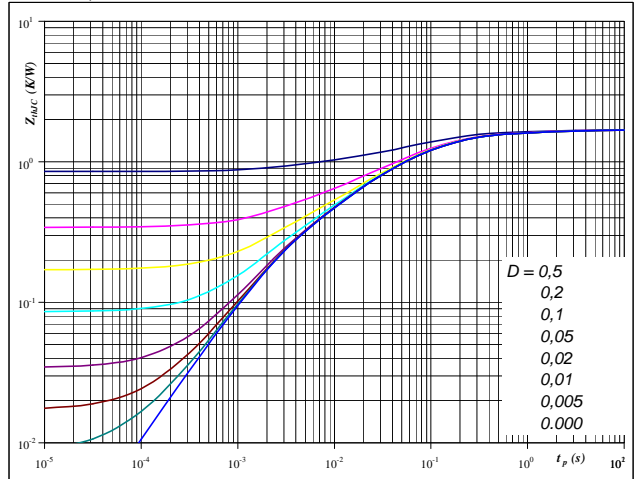
**At**  
 $D = t_p / T$   
 $R_{thJH} = 1,705 \text{ K/W}$ 
**Figure 3** Bypass Diode

**Power dissipation as a function of heatsink temperature**

$$P_{tot} = f(T_h)$$

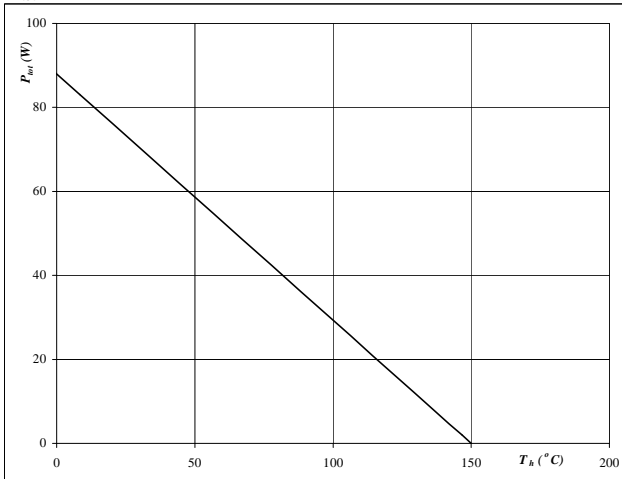
**At**  
 $T_j = 150 \text{ °C}$ 
**Figure 4** Bypass Diode

**Forward current as a function of heatsink temperature**

$$I_F = f(T_h)$$

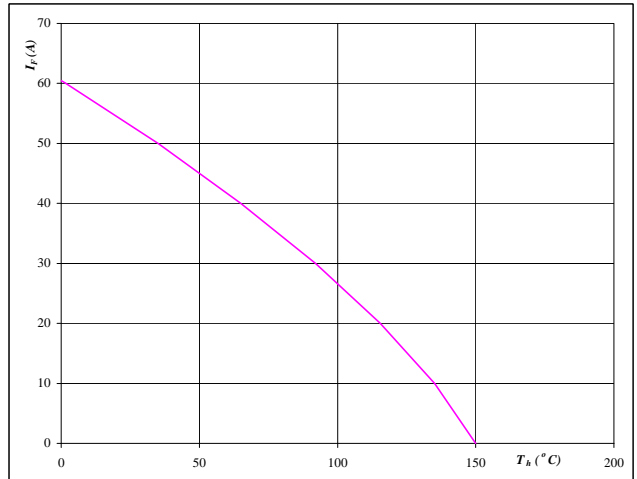

**At**  
 $T_j = 150 \text{ °C}$

## Thermistor

**Figure 1** Thermistor

Typical NTC characteristic  
 as a function of temperature

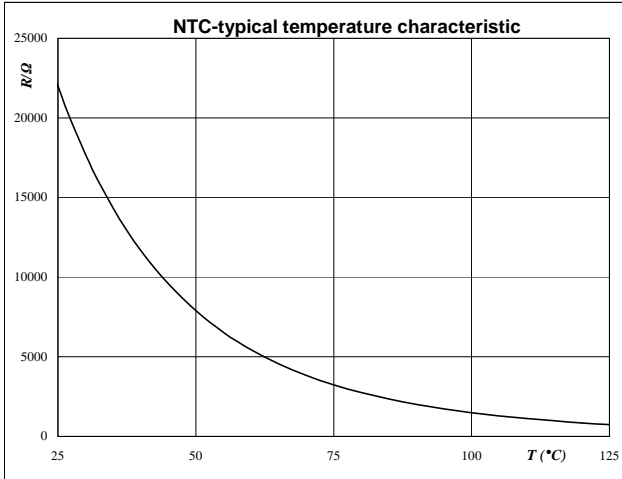
$$R_T = f(T)$$



## Switching Definitions BOOST IGBT

General conditions	
$T_j$	= 125 °C
$R_{gon}$	= 4 Ω
$R_{goff}$	= 4 Ω

**Figure 1** Boost IGBT

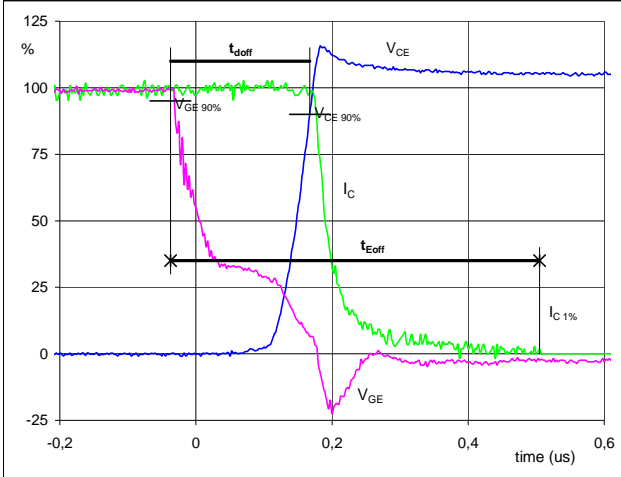
**Turn-off Switching Waveforms & definition of  $t_{doff}$ ,  $t_{Eoff}$**   
 ( $t_{Eoff}$  = integrating time for  $E_{off}$ )

$V_{GE}(0\%) =$	0	V
$V_{GE}(100\%) =$	15	V
$V_C(100\%) =$	700	V
$I_C(100\%) =$	40	A
$t_{doff} =$	0,20	μs
$t_{Eoff} =$	0,54	μs

**Figure 2** Boost IGBT

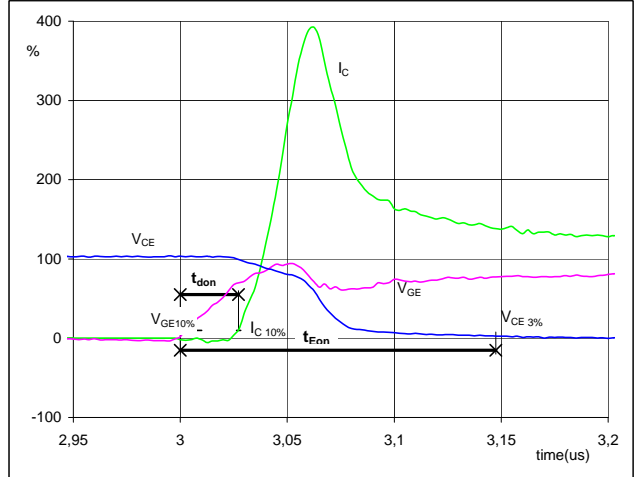
**Turn-on Switching Waveforms & definition of  $t_{don}$ ,  $t_{Eon}$**   
 ( $t_{Eon}$  = integrating time for  $E_{on}$ )

$V_{GE}(0\%) =$	0	V
$V_{GE}(100\%) =$	15	V
$V_C(100\%) =$	700	V
$I_C(100\%) =$	40	A
$t_{don} =$	0,03	μs
$t_{Eon} =$	0,15	μs

**Figure 3** Boost IGBT

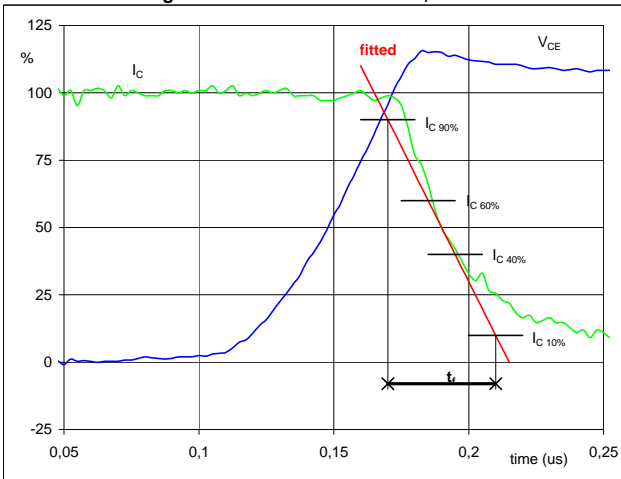
**Turn-off Switching Waveforms & definition of  $t_f$** 

$V_C(100\%) =$	700	V
$I_C(100\%) =$	40	A
$t_f =$	0,04	μs

**Figure 4** Boost IGBT

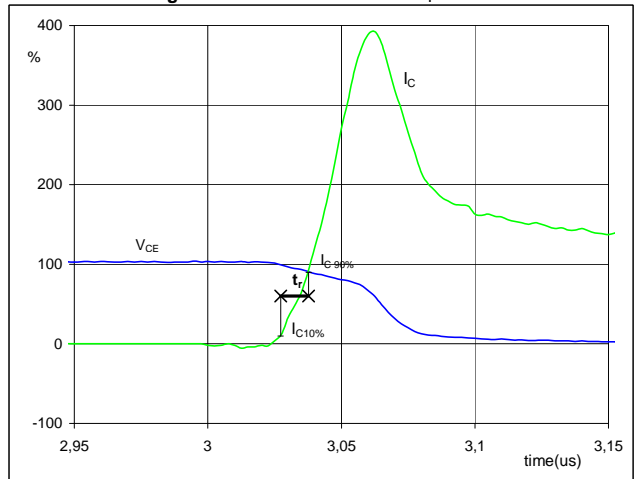
**Turn-on Switching Waveforms & definition of  $t_f$** 

$V_C(100\%) =$	700	V
$I_C(100\%) =$	40	A
$t_f =$	0,01	μs

## Switching Definitions BOOST IGBT

**Figure 5** Boost IGBT

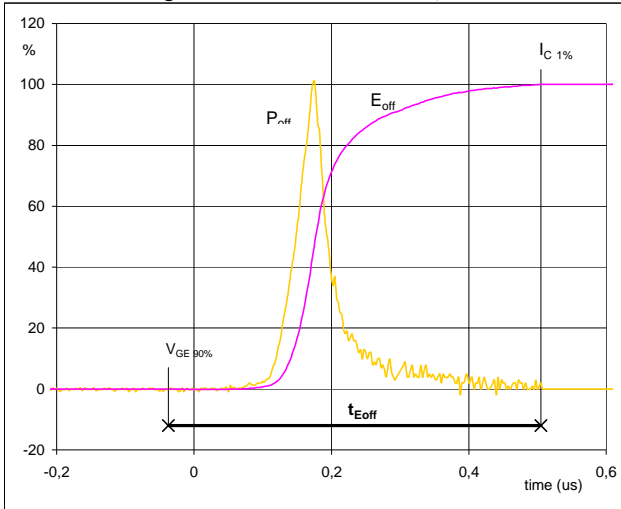
**Turn-off Switching Waveforms & definition of  $t_{Eoff}$** 

$P_{off} (100\%) = 27,95$  kW  
 $E_{off} (100\%) = 1,87$  mJ  
 $t_{Eoff} = 0,54$   $\mu$ s

**Figure 6** Boost IGBT

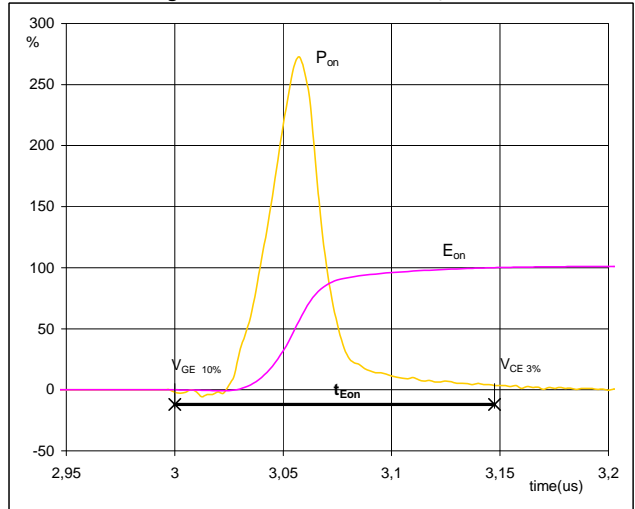
**Turn-on Switching Waveforms & definition of  $t_{Eon}$** 

$P_{on} (100\%) = 27,95$  kW  
 $E_{on} (100\%) = 2,23$  mJ  
 $t_{Eon} = 0,15$   $\mu$ s

**Figure 7** Boost IGBT

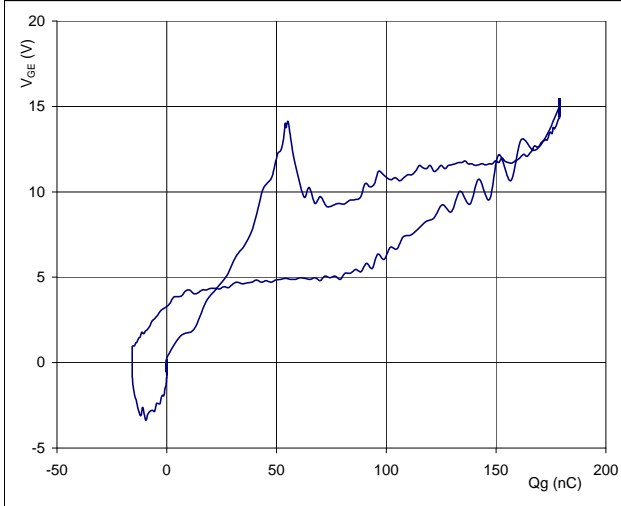
**Gate voltage vs Gate charge (measured)**

$V_{GEoff} = 0$  V  
 $V_{GEon} = 15$  V  
 $V_C (100\%) = 700$  V  
 $I_C (100\%) = 40$  A  
 $Q_g = 178,86$  nC

**Figure 8** Boost FWD

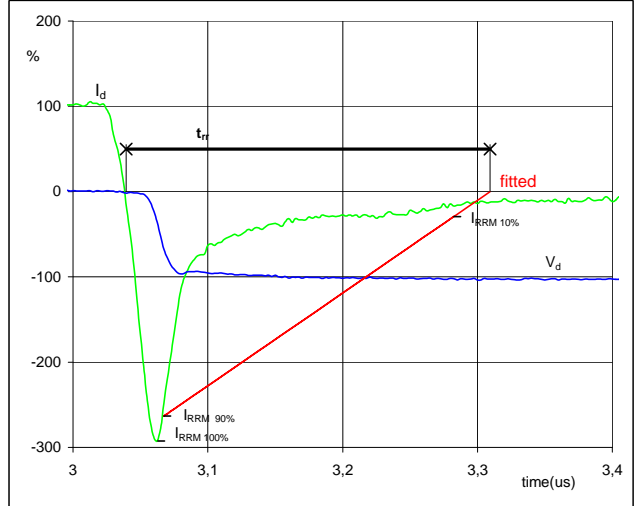
**Turn-off Switching Waveforms & definition of  $t_{rr}$** 

$V_d (100\%) = 700$  V  
 $I_d (100\%) = 40$  A  
 $I_{RRM} (100\%) = -117$  A  
 $t_{rr} = 0,15$   $\mu$ s



## Switching Definitions BOOST FWD

**Figure 9** Boost FWD

Turn-on Switching Waveforms & definition of  $t_{Qrr}$   
 ( $t_{Qrr}$  = integrating time for  $Q_{rr}$ )

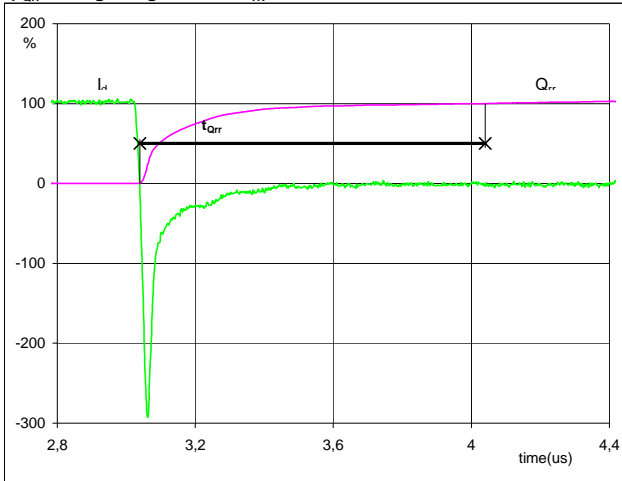

$I_d$ (100%) =	40	A
$Q_{rr}$ (100%) =	7,08	$\mu\text{C}$
$t_{Qrr}$ =	1,00	$\mu\text{s}$

**Figure 10** Boost FWD

Turn-on Switching Waveforms & definition of  $t_{Erec}$   
 ( $t_{Erec}$  = integrating time for  $E_{rec}$ )

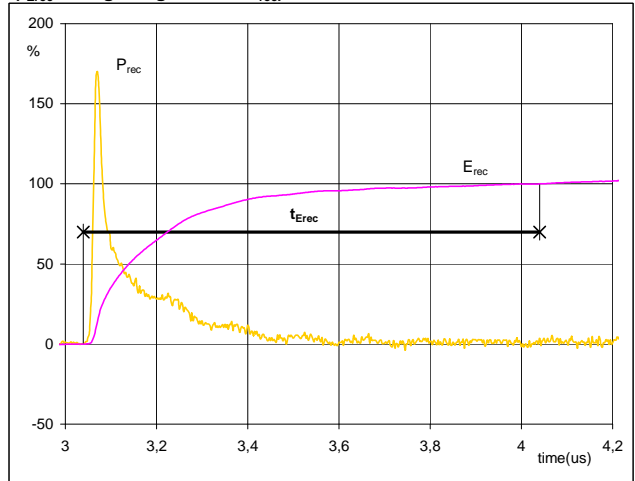

$P_{rec}$ (100%) =	27,95	kW
$E_{rec}$ (100%) =	3,69	mJ
$t_{Erec}$ =	1,00	$\mu\text{s}$

**Ordering Code and Marking - Outline - Pinout**
**Ordering Code & Marking**

Version	Ordering Code	in DataMatrix as	in packaging barcode as
without thermal paste 12mm housing	V23990-P629-F73-PM	P629-F73-PM	P629-F73-PM

**Outline**

Pin table		
Pin	X	Y
1	0	22,5
2	2,9	22,5
3	8,3	22,5
4	10,8	22,5
5	19,6	22,5
6	22,1	22,5
7	29,1	22,5
8	32	22,5
9	33,5	17,8
10	33,5	15,3
11	33,5	7,2
12	33,5	4,7
13	32	0
14	29,1	0
15	22,1	0
16	19,6	0
17	10,8	0
18	8,3	0
19	2,9	0
20	0	0
21	0	8
22	0	14,5

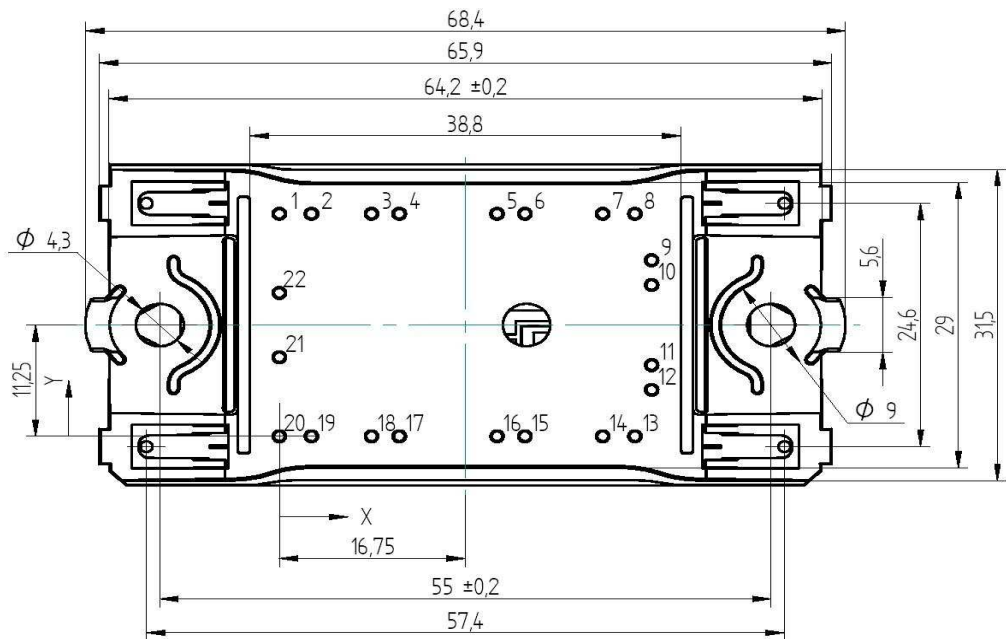
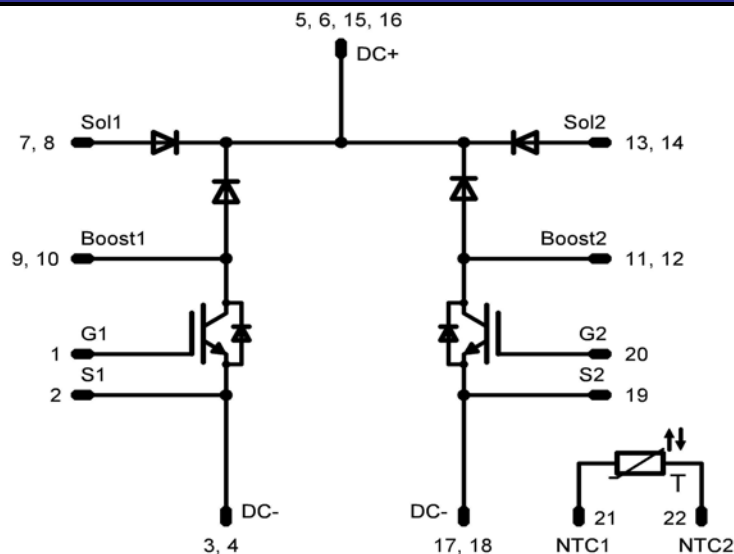
**Pinout**

**PRODUCT STATUS DEFINITIONS**

Datasheet Status	Product Status	Definition
Target	Formative or In Design	This datasheet contains the design specifications for product development. Specifications may change in any manner without notice. The data contained is exclusively intended for technically trained staff.
Preliminary	First Production	This datasheet contains preliminary data, and supplementary data may be published at a later date. Vincotech reserves the right to make changes at any time without notice in order to improve design. The data contained is exclusively intended for technically trained staff.
Final	Full Production	This datasheet contains final specifications. Vincotech reserves the right to make changes at any time without notice in order to improve design. The data contained is exclusively intended for technically trained staff.

**DISCLAIMER**

The information given in this datasheet describes the type of component and does not represent assured characteristics. For tested values please contact Vincotech. Vincotech reserves the right to make changes without further notice to any products herein to improve reliability, function or design. Vincotech does not assume any liability arising out of the application or use of any product or circuit described herein; neither does it convey any license under its patent rights, nor the rights of others.

**LIFE SUPPORT POLICY**

Vincotech products are not authorised for use as critical components in life support devices or systems without the express written approval of Vincotech.

As used herein:

1. Life support devices or systems are devices or systems which, (a) are intended for surgical implant into the body, or (b) support or sustain life, or (c) whose failure to perform when properly used in accordance with instructions for use provided in labelling can be reasonably expected to result in significant injury to the user.
2. A critical component is any component of a life support device or system whose failure to perform can be reasonably expected to cause the failure of the life support device or system, or to affect its safety or effectiveness.